



(12) **United States Design Patent**
Dyson et al.

(10) **Patent No.:** **US D746,425 S**
(45) **Date of Patent:** **** Dec. 29, 2015**

(54) **HUMIDIFIER**

(71) Applicant: **Dyson Technology Limited**, Wiltshire (GB)
(72) Inventors: **James Dyson**, Malmesbury (GB); **Peter David Gammack**, Malmesbury (GB); **Mark Joseph Staniforth**, Malmesbury (GB); **Daniel James Beavis**, Malmesbury (GB); **Jude Paul Pullen**, Malmesbury (GB); **Nicholas Gerald Fitton**, Malmesbury (GB)

(73) Assignee: **Dyson Technology Limited**, Malmesbury, Wiltshire (GB)

(**) Term: **14 Years**

(21) Appl. No.: **29/460,994**

(22) Filed: **Jul. 17, 2013**

(30) **Foreign Application Priority Data**

Jan. 18, 2013 (EM) 001357941-0003

(51) **LOC (10) Cl.** **23-04**

(52) **U.S. Cl.**
USPC **D23/356**

(58) **Field of Classification Search**

USPC D23/314, 325, 329, 333, 334, 335, 342, D23/355, 356, 358, 359, 364, 386, 387, 388, D23/389, 390, 391
CPC A61L 9/00; A61L 9/20; A61L 9/205; A61L 9/01; A61L 9/015; A61L 9/14; A61L 9/16; F24F 1/00; F24F 3/16; F24F 3/166; F24F 3/1603; F24F 3/14; F24F 3/12; F24F 7/00; B03C 1/00; B03C 3/32; B03C 3/15; B03C 3/155; B03C 3/16; B01D 23/00
See application file for complete search history.

(56) **References Cited**

U.S. PATENT DOCUMENTS

284,962 A 9/1883 Huston
1,357,261 A 11/1920 Svoboda
1,767,060 A 6/1930 Ferguson
1,896,869 A 2/1933 Larsh
2,014,185 A 9/1935 Martin
2,035,733 A 3/1936 Wall

(Continued)

FOREIGN PATENT DOCUMENTS

BE 560119 8/1957
CA 1055344 5/1979

(Continued)

OTHER PUBLICATIONS

Dos Reis et al., U.S. Office Action mailed Sep. 23, 2014, directed to U.S. Appl. No. 29/466,240; 9 pages.

(Continued)

Primary Examiner — Eric Goodman
Assistant Examiner — Bao-Yen Nguyen
(74) *Attorney, Agent, or Firm* — Morrison & Foerster LLP

(57) **CLAIM**

We claim the ornamental design for a humidifier, as shown and described.

DESCRIPTION

FIG. 1 is a perspective view of a humidifier showing our new design;
FIG. 2 is a front view thereof;
FIG. 3 is a rear view thereof;
FIG. 4 is a side view thereof;
FIG. 5 is a side view of the opposite side of FIG. 4;
FIG. 6 is a top view thereof; and,
FIG. 7 is a bottom view thereof.
The dash-dot line depicts the bounds of the claim.

1 Claim, 7 Drawing Sheets

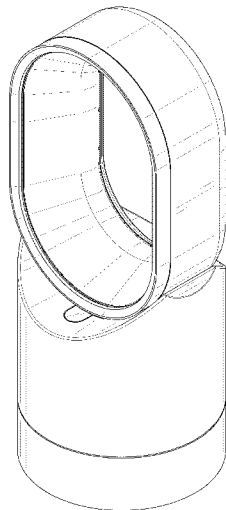

(56)

References Cited

U.S. PATENT DOCUMENTS

2,071,266 A	2/1937	Schmidt	5,188,508 A	2/1993	Scott et al.
D103,476 S	3/1937	Weber	D343,231 S	1/1994	Lim
2,115,883 A	5/1938	Sher	5,296,769 A	3/1994	Havens et al.
D115,344 S	6/1939	Chapman	D346,017 S	4/1994	Lim
2,210,458 A	8/1940	Keilholtz	5,310,313 A	5/1994	Chen
2,258,961 A	10/1941	Saathoff	5,317,815 A	6/1994	Hwang
2,295,502 A	9/1942	Lamb	5,338,495 A	8/1994	Steiner et al.
2,336,295 A	12/1943	Reimuller	5,402,938 A	4/1995	Sweeney
2,363,839 A	11/1944	Demuth	5,407,324 A	4/1995	Starnes, Jr. et al.
2,433,795 A	12/1947	Stokes	5,425,902 A	6/1995	Miller et al.
2,473,325 A	6/1949	Aufiero	5,435,489 A	7/1995	Jenkins et al.
2,476,002 A	7/1949	Stalker	5,483,616 A	1/1996	Chiu et al.
2,488,467 A	11/1949	De Lisio	5,518,370 A	5/1996	Wang et al.
2,510,132 A	6/1950	Morrison	D374,712 S	10/1996	Jane et al.
2,544,379 A	3/1951	Davenport	5,609,473 A	3/1997	Litvin
2,547,448 A	4/1951	Demuth	5,645,769 A	7/1997	Tamaru et al.
2,583,374 A	1/1952	Hoffman	5,649,370 A	7/1997	Russo
2,620,127 A	12/1952	Radcliffe	D382,951 S	8/1997	Deines et al.
2,711,682 A	6/1955	Drechsel	5,671,321 A	9/1997	Bagnuolo
2,765,977 A	10/1956	Morrison	5,677,982 A	10/1997	Levine et al.
2,808,198 A	10/1957	Morrison	5,706,985 A	1/1998	Feer
2,813,673 A	11/1957	Smith	5,735,683 A	4/1998	Muschelknautz
2,830,779 A	4/1958	Wentling	5,762,034 A	6/1998	Foss
2,838,229 A	6/1958	Belanger	5,762,661 A	6/1998	Kleinberger et al.
2,922,277 A	1/1960	Bertin	5,783,117 A	7/1998	Byassee et al.
2,922,570 A	1/1960	Allen	5,794,306 A	8/1998	Firdaus
3,004,403 A	10/1961	Laporte	D398,983 S	9/1998	Keller et al.
3,047,208 A	7/1962	Coanda	5,841,080 A	11/1998	Iida et al.
3,270,655 A	9/1966	Guirl et al.	5,843,344 A	12/1998	Junkel et al.
D206,973 S	2/1967	De Lisio	5,859,952 A	1/1999	Levine et al.
3,503,138 A	3/1970	Fuchs et al.	5,862,037 A	1/1999	Behl
3,518,776 A	7/1970	Wolff et al.	5,868,197 A	2/1999	Potier
3,724,092 A	4/1973	McCleerey	5,881,685 A	3/1999	Foss et al.
3,729,934 A	5/1973	Denning et al.	D415,271 S	10/1999	Feer
3,743,186 A	7/1973	Mocarski	6,015,274 A	1/2000	Bias et al.
3,795,367 A	3/1974	Mocarski	D423,663 S	4/2000	Rossmann et al.
3,872,916 A	3/1975	Beck	6,073,881 A	6/2000	Chen
3,875,745 A	4/1975	Franklin	D429,808 S	8/2000	Krauss et al.
3,885,891 A	5/1975	Thronsdon	6,123,618 A	9/2000	Day
3,943,329 A	3/1976	Hlavac	6,155,782 A	12/2000	Hsu
4,037,991 A	7/1977	Taylor	D435,899 S	1/2001	Melwani
4,046,492 A	9/1977	Inglis	6,200,155 B1	3/2001	Chudkosky et al.
4,061,188 A	12/1977	Beck	6,254,337 B1	7/2001	Arnold
4,073,613 A	2/1978	Desty	6,269,549 B1	8/2001	Carlucci et al.
4,090,814 A	5/1978	Teodorescu et al.	6,278,248 B1	8/2001	Hong et al.
4,113,416 A	9/1978	Kataoka et al.	6,282,746 B1	9/2001	Schleeter
4,136,735 A	1/1979	Beck et al.	6,293,121 B1	9/2001	Labrador
4,173,995 A	11/1979	Beck	6,321,034 B2	11/2001	Jones-Lawlor et al.
4,180,130 A	12/1979	Beck et al.	6,386,845 B1	5/2002	Bedard
4,184,417 A	1/1980	Chancellor	6,480,672 B1	11/2002	Rosenzweig et al.
4,184,541 A	1/1980	Beck et al.	6,599,088 B2	7/2003	Stagg
4,192,461 A	3/1980	Arborg	6,604,694 B1	8/2003	Kordas et al.
4,264,837 A	4/1981	Gaboriaud	D483,851 S	12/2003	Fok
4,332,529 A	6/1982	Alperin	D485,895 S	1/2004	Melwani
4,336,017 A	6/1982	Desty	D486,903 S	2/2004	Chiang
4,342,204 A	8/1982	Melikian et al.	6,715,739 B2	4/2004	Mulvaney et al.
4,448,354 A	5/1984	Reznick et al.	6,789,787 B2	9/2004	Stutts
4,568,243 A	2/1986	Schubert et al.	6,791,056 B2	9/2004	VanOtteren et al.
4,630,475 A	12/1986	Mizoguchi	6,830,433 B2	12/2004	Birdsell et al.
4,643,351 A	2/1987	Fukamachi et al.	6,845,971 B2	1/2005	Bachert
4,703,152 A	10/1987	Shih-Chin	D512,772 S	12/2005	Lee
4,716,946 A	1/1988	Grigoletto	D513,067 S	12/2005	Blateri
4,718,870 A	1/1988	Watts	7,059,826 B2	6/2006	Lasko
4,732,539 A	3/1988	Shin-Chin	7,088,913 B1	8/2006	Verhoorn et al.
4,734,017 A	3/1988	Levin	7,147,336 B1	12/2006	Chou
4,790,133 A	12/1988	Stuart	D539,414 S	3/2007	Russak et al.
4,850,804 A	7/1989	Huang	7,192,258 B2	3/2007	Kuo et al.
4,878,620 A	11/1989	Tarleton	7,198,473 B2	4/2007	Stickland et al.
4,893,990 A	1/1990	Tomohiro et al.	D544,078 S *	6/2007	Geringer D23/328
4,978,281 A	12/1990	Conger	7,412,781 B2	8/2008	Mattinger et al.
5,061,405 A	10/1991	Stanek et al.	7,478,993 B2	1/2009	Hong et al.
D325,435 S	4/1992	Coup et al.	7,540,474 B1	6/2009	Huang et al.
5,110,266 A	5/1992	Toyoshima et al.	D595,835 S	7/2009	Fu
5,168,722 A	12/1992	Brock	D598,532 S	8/2009	Dyson et al.
5,176,856 A	1/1993	Takahashi et al.	D602,143 S	10/2009	Gammack et al.
			D602,144 S	10/2009	Dyson et al.
			D605,748 S	12/2009	Gammack et al.
			7,660,110 B2	2/2010	Vinson et al.
			7,664,377 B2	2/2010	Liao

(56)

References Cited

U.S. PATENT DOCUMENTS

D614,280	S	4/2010	Dyson et al.	2008/0124060	A1	5/2008	Gao
7,731,050	B2	6/2010	Parks et al.	2008/0152482	A1	6/2008	Patel
7,775,848	B1	8/2010	Auerbach	2008/0166224	A1	7/2008	Giffin
7,806,388	B2	10/2010	Junkel et al.	2008/0286130	A1	11/2008	Purvines
7,841,045	B2	11/2010	Shaanan et al.	2008/0314250	A1	12/2008	Cowie et al.
D633,997	S	3/2011	Hideharu et al.	2009/0026850	A1	1/2009	Fu
D633,999	S	3/2011	Hideharu et al.	2009/0032130	A1	2/2009	Dumas et al.
7,931,449	B2	4/2011	Fitton et al.	2009/0039805	A1	2/2009	Tang
D638,114	S	5/2011	Li et al.	2009/0060710	A1	3/2009	Gammack et al.
D643,098	S	8/2011	Wallace et al.	2009/0060711	A1	3/2009	Gammack et al.
8,002,520	B2	8/2011	Dawson et al.	2009/0078120	A1	3/2009	Kummer et al.
D644,726	S *	9/2011	Hideharu et al. D23/370	2009/0120925	A1	5/2009	Lasko
D645,133	S *	9/2011	Hideharu D23/370	2009/0191054	A1	7/2009	Winkler
D646,373	S	10/2011	Liebson et al.	2009/0214341	A1	8/2009	Craig
8,092,166	B2	1/2012	Nicolas et al.	2010/0133707	A1	6/2010	Huang
8,113,490	B2	2/2012	Chen	2010/0150699	A1	6/2010	Nicolas et al.
8,152,495	B2	4/2012	Bogges, Jr. et al.	2010/0162011	A1	6/2010	Min
8,246,317	B2	8/2012	Gammack	2010/0171465	A1	7/2010	Seal et al.
D669,164	S	10/2012	Hsu	2010/0225012	A1	9/2010	Fitton et al.
8,308,445	B2	11/2012	Gammack et al.	2010/0226749	A1	9/2010	Gammack et al.
D672,023	S	12/2012	Wallace et al.	2010/0226750	A1	9/2010	Gammack
D672,024	S	12/2012	Fitton et al.	2010/0226751	A1	9/2010	Gammack et al.
8,348,629	B2	1/2013	Fitton et al.	2010/0226752	A1	9/2010	Gammack et al.
8,356,804	B2	1/2013	Fitton et al.	2010/0226753	A1	9/2010	Dyson et al.
D676,536	S *	2/2013	Roach et al. D23/328	2010/0226754	A1	9/2010	Hutton et al.
D678,993	S	3/2013	Kung-Hua	2010/0226758	A1	9/2010	Cookson et al.
8,403,640	B2	3/2013	Gammack et al.	2010/0226763	A1	9/2010	Gammack et al.
8,408,869	B2	4/2013	Hutton et al.	2010/0226764	A1	9/2010	Gammack et al.
D681,793	S	5/2013	Li	2010/0226769	A1	9/2010	Helps
D684,249	S	6/2013	Herbst	2010/0226771	A1	9/2010	Crawford et al.
8,454,322	B2	6/2013	Gammack et al.	2010/0226787	A1	9/2010	Gammack et al.
8,469,660	B2	6/2013	Dyson et al.	2010/0226797	A1	9/2010	Fitton et al.
8,529,226	B2	9/2013	Li	2010/0226801	A1	9/2010	Gammack
8,544,826	B2	10/2013	Ediger et al.	2010/0254800	A1	10/2010	Fitton et al.
D698,018	S *	1/2014	Choi D23/366	2011/0058935	A1	3/2011	Gammack et al.
D700,959	S	3/2014	Sickinger et al.	2011/0110805	A1	5/2011	Gammack et al.
8,684,687	B2	4/2014	Dyson et al.	2011/0164959	A1	7/2011	Fitton et al.
D705,415	S	5/2014	Lo	2011/0223014	A1	9/2011	Crawford et al.
8,721,286	B2	5/2014	Gammack et al.	2011/0223015	A1	9/2011	Gammack et al.
8,721,307	B2	5/2014	Li	2011/0236228	A1	9/2011	Fitton et al.
8,764,412	B2	7/2014	Gammack et al.	2012/0031509	A1	2/2012	Wallace et al.
8,783,663	B2	7/2014	Fitton et al.	2012/0033952	A1	2/2012	Wallace et al.
8,784,071	B2	7/2014	Gammack	2012/0034108	A1	2/2012	Wallace et al.
2001/0017212	A1	8/2001	Hirano	2012/0039705	A1	2/2012	Gammack
2002/0104972	A1	8/2002	Guzorek	2012/0045315	A1	2/2012	Gammack
2002/0106547	A1	8/2002	Sugawara et al.	2012/0045316	A1	2/2012	Gammack
2003/0059307	A1	3/2003	Moreno et al.	2012/0051884	A1	3/2012	Junkel et al.
2003/0164367	A1	9/2003	Bucher et al.	2012/0057959	A1	3/2012	Hodgson et al.
2003/0171093	A1	9/2003	Gumucio Del Pozo	2012/0082561	A1	4/2012	Gammack et al.
2003/0190183	A1	10/2003	Hsing	2012/0093629	A1	4/2012	Fitton et al.
2004/0022631	A1	2/2004	Birdsell et al.	2012/0093630	A1	4/2012	Fitton et al.
2004/0049842	A1	3/2004	Prehodka	2012/0114513	A1	5/2012	Simmonds et al.
2004/0106370	A1	6/2004	Honda et al.	2012/0230658	A1	9/2012	Fitton et al.
2004/0149881	A1	8/2004	Allen	2012/0308375	A1	12/2012	Gammack
2005/0031448	A1	2/2005	Lasko et al.	2012/0318393	A1 *	12/2012	Tsen 137/803
2005/0053465	A1	3/2005	Roach et al.	2013/0011252	A1	1/2013	Crawford et al.
2005/0069407	A1	3/2005	Winkler et al.	2013/0026664	A1	1/2013	Staniforth et al.
2005/0128698	A1	6/2005	Huang	2013/0028763	A1	1/2013	Staniforth et al.
2005/0163670	A1	7/2005	Alleyne et al.	2013/0028766	A1	1/2013	Staniforth et al.
2005/0173997	A1	8/2005	Schmid et al.	2013/0077292	A1 *	3/2013	Zimmerman 362/142
2005/0258554	A1	11/2005	Bachert	2013/0129490	A1	5/2013	Dos Reis et al.
2005/0281672	A1	12/2005	Parker et al.	2013/0142676	A1	6/2013	Zou
2006/0172682	A1	8/2006	Orr et al.	2013/0161842	A1	6/2013	Fitton et al.
2006/0199515	A1	9/2006	Lasko et al.	2013/0175711	A1	7/2013	Nutter et al.
2006/0263073	A1	11/2006	Clarke et al.	2013/0199372	A1	8/2013	Nock et al.
2006/0279927	A1	12/2006	Strohm	2013/0234346	A1	9/2013	Staniforth et al.
2007/0035189	A1	2/2007	Matsumoto	2013/0234347	A1	9/2013	Staniforth et al.
2007/0041857	A1	2/2007	Fleig	2013/0249122	A1	9/2013	Staniforth et al.
2007/0065280	A1	3/2007	Fok	2013/0249124	A1	9/2013	Staniforth et al.
2007/0166160	A1	7/2007	Russak et al.	2013/0272858	A1	10/2013	Stickney et al.
2007/0176502	A1	8/2007	Kasai et al.	2013/0280051	A1	10/2013	Nicolas et al.
2007/0224044	A1	9/2007	Hong et al.	2013/0280061	A1	10/2013	Stickney
2007/0237500	A1	10/2007	Wang	2013/0280096	A1	10/2013	Gammack et al.
2007/0269323	A1	11/2007	Zhou et al.	2013/0309065	A1	11/2013	Johnson et al.
2008/0020698	A1	1/2008	Spaggiari	2013/0309080	A1	11/2013	Johnson et al.
				2013/0323100	A1	12/2013	Poulton et al.
				2013/0336771	A1	12/2013	Dyson et al.
				2014/0017069	A1	1/2014	Peters

(56)

References Cited

U.S. PATENT DOCUMENTS

2014/0077398 A1 3/2014 Staniforth et al.
 2014/0079566 A1 3/2014 Gammack et al.
 2014/0084492 A1 3/2014 Staniforth et al.
 2014/0210114 A1 7/2014 Staniforth et al.
 2014/0210115 A1 7/2014 Staniforth et al.
 2014/0255173 A1 9/2014 Poulton et al.
 2014/0255217 A1 9/2014 Li
 2015/0084214 A1 3/2015 Wilson et al.

FOREIGN PATENT DOCUMENTS

CA 2155482 9/1996
 CH 346643 5/1960
 CN 2085866 10/1991
 CN 2111392 7/1992
 CN 2549372 5/2003
 CN 1437300 8/2003
 CN 2650005 10/2004
 CN 2713643 7/2005
 CN 1680727 10/2005
 CN 1724950 1/2006
 CN 2833197 11/2006
 CN 201011346 1/2008
 CN 201147215 11/2008
 CN 201180678 1/2009
 CN 201221477 4/2009
 CN 101424279 5/2009
 CN 101451754 6/2009
 CN 201281416 7/2009
 CN 201349269 11/2009
 CN 101684828 3/2010
 CN 201486901 5/2010
 CN 101726100 6/2010
 CN 101749288 6/2010
 CN 201502549 6/2010
 CN 201507461 6/2010
 CN 201518985 7/2010
 CN 101825096 9/2010
 CN 101825101 9/2010
 CN 101825102 9/2010
 CN 101825103 9/2010
 CN 101825104 9/2010
 CN 101825324 9/2010
 CN 201568337 9/2010
 CN 101858355 10/2010
 CN 101936310 1/2011
 CN 201696365 U 1/2011
 CN 201696366 1/2011
 CN 201739199 2/2011
 CN 101984299 3/2011
 CN 101985948 3/2011
 CN 201763705 3/2011
 CN 201763706 3/2011
 CN 201770513 3/2011
 CN 201771875 3/2011
 CN 201779080 3/2011
 CN 201786777 4/2011
 CN 201786778 4/2011
 CN 201802648 4/2011
 CN 301539668 5/2011
 CN 102095236 6/2011
 CN 201858204 6/2011
 CN 201874898 6/2011
 CN 201874901 6/2011
 CN 201917047 8/2011
 CN 102251973 11/2011
 CN 102287357 12/2011
 CN 202101355 1/2012
 CN 102367813 3/2012
 CN 202267207 6/2012
 CN 301949285 6/2012
 CN 202431623 9/2012
 CN 102900654 1/2013
 CN 103697556 4/2014

DE 1 291 090 3/1969
 DE 24 51 557 5/1976
 DE 27 48 724 5/1978
 DE 3644567 7/1988
 DE 195 10 397 9/1996
 DE 197 12 228 10/1998
 DE 100 00 400 3/2001
 DE 10041805 6/2002
 DE 10 2009 007 8/2010
 EP 0 044 494 1/1982
 EP 0186581 7/1986
 EP 0 459 812 12/1991
 EP 0 784 947 7/1997
 EP 1 094 224 4/2001
 EP 1 138 954 10/2001
 EP 1357296 B1 10/2003
 EP 1 779 745 5/2007
 EP 1 939 456 7/2008
 EP 1 980 432 10/2008
 EP 2 000 675 12/2008
 EP 2191142 6/2010
 EP 2 230 467 9/2010
 EP 2 414 738 2/2012
 EP 2 578 889 4/2013
 FR 1033034 7/1953
 FR 1119439 6/1956
 FR 1.387.334 1/1965
 FR 2 375 471 7/1978
 FR 2 534 983 4/1984
 FR 2 640 857 6/1990
 FR 2 658 593 8/1991
 FR 2794195 12/2000
 FR 2 874 409 2/2006
 FR 2 906 980 4/2008
 FR 2928706 9/2009
 GB 22235 0/1914
 GB 383498 11/1932
 GB 593828 10/1947
 GB 601222 4/1948
 GB 633273 12/1949
 GB 641622 8/1950
 GB 661747 11/1951
 GB 861749 2/1961
 GB 863 124 3/1961
 GB 1067956 5/1967
 GB 1 262 131 2/1972
 GB 1 265 341 3/1972
 GB 1 278 606 6/1972
 GB 1 304 560 1/1973
 GB 1 403 188 8/1975
 GB 1 434 226 5/1976
 GB 1 501 473 2/1978
 GB 2 094 400 9/1982
 GB 2 107 787 5/1983
 GB 2 111 125 6/1983
 GB 2 178 256 2/1987
 GB 2 185 531 7/1987
 GB 2 185 533 7/1987
 GB 2 218 196 11/1989
 GB 2 236 804 4/1991
 GB 2 240 268 7/1991
 GB 2 242 935 10/1991
 GB 2 285 504 7/1995
 GB 2 289 087 11/1995
 GB 2383277 6/2003
 GB 2 428 569 2/2007
 GB 2 452 593 3/2009
 GB 2452490 3/2009
 GB 2463698 3/2010
 GB 2464736 4/2010
 GB 2466058 6/2010
 GB 2468312 9/2010
 GB 2468313 9/2010
 GB 2468315 9/2010
 GB 2468317 9/2010
 GB 2468319 9/2010
 GB 2468320 9/2010
 GB 2468323 9/2010
 GB 2468328 9/2010

(56)

References Cited

FOREIGN PATENT DOCUMENTS

GB	2468329	9/2010	JP	2000-116179	4/2000
GB	2468331	9/2010	JP	2000-201723	7/2000
GB	2468369	9/2010	JP	2001-17358	1/2001
GB	2468498	9/2010	JP	2002-21797	1/2002
GB	2473037	3/2011	JP	2002-138829	5/2002
GB	2479760	10/2011	JP	2002-213388	7/2002
GB	2482547	2/2012	JP	2003-4265	1/2003
GB	2484671	4/2012	JP	2003-161473	6/2003
GB	2484695	4/2012	JP	2003-329273	11/2003
GB	2484761	4/2012	JP	2004-8275	1/2004
GB	2493231	1/2013	JP	2004-208935	7/2004
GB	2493505	2/2013	JP	2004-216221	8/2004
GB	2493507	2/2013	JP	2005-201507	7/2005
GB	2499041	8/2013	JP	2005-307985	11/2005
GB	2500005	9/2013	JP	2006-89096	4/2006
GB	2500010	9/2013	JP	2006-189221	7/2006
GB	2500011	9/2013	JP	3127331	11/2006
GB	2500012	9/2013	JP	2007-138763	6/2007
JP	31-13055	8/1956	JP	2007-138789	6/2007
JP	35-4369	3/1960	JP	2008-39316	2/2008
JP	39-7297	3/1964	JP	2008-100204	5/2008
JP	46-7230	12/1971	JP	3144127	8/2008
JP	47-21718	10/1972	JP	3146538	10/2008
JP	49-43764	4/1974	JP	2008-294243	12/2008
JP	49-150403	12/1974	JP	2009-44568	2/2009
JP	50-92046	8/1975	JP	2009-62986	3/2009
JP	51-7258	1/1976	JP	D1371413	10/2009
JP	52-121045	9/1977	JP	2009-275925	11/2009
JP	53-60100	5/1978	JP	D1376284	12/2009
JP	56-167897	12/1981	JP	2010-46411	3/2010
JP	57-71000	5/1982	JP	2010-131259	6/2010
JP	57-157097	9/1982	JP	2010-203760	9/2010
JP	61-31830	2/1986	JP	2010-203764	9/2010
JP	61-116093	6/1986	JP	2012-31806	2/2012
JP	61-280787	12/1986	KR	1999-002660	1/1999
JP	62-98099	5/1987	KR	10-2005-0102317	10/2005
JP	62-223494	10/1987	KR	2007-0007997	1/2007
JP	63-36794	3/1988	KR	20-0448319	3/2010
JP	63-179198	7/1988	KR	10-2010-0055611	5/2010
JP	63-198933	12/1988	KR	10-0985378	9/2010
JP	63-306340	12/1988	TW	517825	1/2003
JP	64-21300 U	2/1989	TW	589932	6/2004
JP	64-58955	3/1989	TW	M394383	12/2010
JP	64-83884	3/1989	TW	M399207	3/2011
JP	1-138399	5/1989	TW	M407299	7/2011
JP	1-224598	9/1989	WO	WO-90/13478	11/1990
JP	2-146294	6/1990	WO	WO-95/06822	3/1995
JP	2-218890	8/1990	WO	WO-02/073096	9/2002
JP	2-248690	10/1990	WO	WO-03/058795	7/2003
JP	3-52515	5/1991	WO	WO-03/069931	8/2003
JP	3-267598	11/1991	WO	WO-2005/050026	6/2005
JP	3-286775	12/1991	WO	WO-2005/057091	6/2005
JP	4-43895	2/1992	WO	WO-2006/008021	1/2006
JP	4-366330	12/1992	WO	WO-2006/012526	2/2006
JP	5-99386	4/1993	WO	WO-2007/024955	3/2007
JP	5-157093	6/1993	WO	WO-2007/048205	5/2007
JP	5-164089	6/1993	WO	WO-2008/014641	2/2008
JP	5-263786	10/1993	WO	WO-2008/024569	2/2008
JP	6-74190	3/1994	WO	WO-2008/139491	11/2008
JP	6-86898	3/1994	WO	WO-2009/030879	3/2009
JP	6-147188	5/1994	WO	WO-2009/030881	3/2009
JP	6-257591	9/1994	WO	WO-2010/100449	9/2010
JP	6-280800	10/1994	WO	WO-2010/100451	9/2010
JP	6-336113	12/1994	WO	WO-2010/100452	9/2010
JP	7-190443	7/1995	WO	WO-2010/100453	9/2010
JP	8-21400	1/1996	WO	WO-2010/100462	9/2010
JP	8-72525	3/1996	WO	WO-2011/050041	4/2011
JP	8-313019	11/1996	WO	WO-2011/147318	12/2011
JP	9-100800	4/1997	WO	WO-2012/006882	1/2012
JP	9-178083	7/1997	WO	WO-2012/033517	3/2012
JP	9-287600	11/1997	WO	WO-2012/052737	4/2012
JP	11-83094	3/1999	WO	WO-2013/014419	1/2013
JP	11-502586	3/1999	WO	WO-2013/132218	9/2013
JP	11-227866	8/1999			
JP	2000-55419	2/2000			

OTHER PUBLICATIONS

Dos Reis et al., U.S. Office Action mailed Sep. 24, 2014, directed to U.S. Appl. No. 29/466,229; 9 pages.

Dos Reis et al., U.S. Office Action mailed Sep. 19, 2014, directed to U.S. Appl. No. 29/466,190; 9 pages.

(56)

References Cited

OTHER PUBLICATIONS

- Mcperson et al., U.S. Office Action mailed Sep. 19, 2014, directed to U.S. Appl. No. 29/466,094; 8 pages.
- Mcperson et al., U.S. Office Action mailed Sep. 19, 2014, directed to U.S. Appl. No. 29/466,241; 8 pages.
- Mcperson et al., U.S. Office Action mailed Sep. 19, 2014, directed to U.S. Appl. No. 29/466,253; 7 pages.
- Dyson et al., U.S. Office Action mailed Sep. 12, 2014, directed to U.S. Appl. No. 29/480,896; 10 pages.
- Dyson et al., U.S. Office Action mailed Sep. 12, 2014, directed to U.S. Appl. No. 29/480,915; 9 pages.
- Poulton et al., U.S. Office Action mailed Sep. 12, 2014, directed to U.S. Appl. No. 29/480,919; 10 pages.
- Deniss. (Sep. 9, 2010) "iFan, The Chinese Clone of the Dyson Air Multiplier," located at <<http://chinitech.com/en/chinese-clones/ifan-le-clone-chinois-du-dyson-air-multiplier>> visited on Aug. 29, 2014. (6 pages).
- Ameec. (Mar. 29, 2012) "Breeze Right Bladeless Fan Up to 41% Off," located at <<http://madamedeals.com/breeze-right-bladeless-fan-up-to-41-off/>> visited on Sep. 3, 2014. (2 pages).
- Questel. (Jun. 11, 2014) "Designs-Questel" located at <<http://sobjprd.questel.fr/export/QPTUJ214/pdf2/19f053ea-a60f-4c58-9232-c458147a9adf-224304.pdf>> visited on Sep. 4, 2014. (67 pages).
- Amazon. "Pisenic Bladeless Fan 16 Inches with Remote Control, Bladeless Fan Air Conditioner 110v, Air Multiplier Table Fans, Green," located at <http://www.amazon.com/Pisenic-Bladeless-Fan-16-Conditioner/dp/B007VCI78M%3FSub-descriptionid%3DPAKIAJYLII7AAJMX7ETAA%26tag%3Dtk78-20%26linkCode%3Dxm%26camp%3D2025%26creative%3D165953%26creativeASIN%3DDB007VCI78M#cm_cr_dpwidget> visited on Sep. 2, 2014. (4 pages).
- Steiner, L., (May 14, 2013) "Dyson Fan Heater Review: Cozy Up to Dyson Fan Heater," located at <<http://www.vissbiz.com/dyson-fan-heater-review/cozy-up-to-dyson-fan-heater/>> visited on Sep. 3, 2014. (3 pages).
- Li et al., U.S. Office Action mailed Oct. 25, 2013, directed to U.S. Appl. No. 13/686,480; 17 pages.
- Gammack et al., U.S. Office Action mailed Apr. 24, 2014, directed to U.S. Appl. No. 12/716,740; 16 pages.
- Gammack, P. et al., U.S. Office Action mailed Dec. 9, 2010, directed to U.S. Appl. No. 12/203,698; 10 pages.
- Gammack, P. et al., U.S. Office Action mailed Jun. 21, 2011, directed to U.S. Appl. No. 12/203,698; 11 pages.
- Gammack et al., Office Action mailed Sep. 17, 2012, directed to U.S. Appl. No. 13/114,707; 12 pages.
- Gammack, P. et al., U.S. Office Action mailed Dec. 10, 2010, directed to U.S. Appl. No. 12/230,613; 12 pages.
- Gammack, P. et al., U.S. Office Action mailed May 13, 2011, directed to U.S. Appl. No. 12/230,613; 13 pages.
- Gammack, P. et al., U.S. Office Action mailed Sep. 7, 2011, directed to U.S. Appl. No. 12/230,613; 15 pages.
- Gammack, P. et al., U.S. Office Action mailed Jun. 8, 2012, directed to U.S. Appl. No. 12/230,613; 15 pages.
- Gammack et al., U.S. Office Action mailed Aug. 20, 2012, directed to U.S. Appl. No. 12/945,558; 15 pages.
- Gammack et al., U.S. Office Action mailed Feb. 28, 2013, directed to U.S. Appl. No. 12/945,558; 16 pages.
- Gammack et al., Office Action mailed Jun. 12, 2013, directed towards U.S. Appl. No. 12/945,558; 20 pages.
- Fitton et al., U.S. Office Action mailed Nov. 30, 2010 directed to U.S. Appl. No. 12/560,232; 9 pages.
- Nicolas, F. et al., U.S. Office Action mailed Mar. 7, 2011, directed to U.S. Appl. No. 12/622,844; 10 pages.
- Nicolas, F. et al., U.S. Office Action mailed Sep. 8, 2011, directed to U.S. Appl. No. 12/622,844; 11 pages.
- Helps, D. F. et al., U.S. Office Action mailed Feb. 15, 2013, directed to U.S. Appl. No. 12/716,694; 12 pages.
- Fitton, et al., U.S. Office Action mailed Mar. 8, 2011, directed to U.S. Appl. No. 12/716,780; 12 pages.
- Fitton, et al., U.S. Office Action mailed Sep. 6, 2011, directed to U.S. Appl. No. 12/716,780; 16 pages.
- Gammack, P. et al., U.S. Office Action mailed Feb. 14, 2013, directed to U.S. Appl. No. 12/716,515; 21 pages.
- Gammack, P. et al., U.S. Office Action mailed Aug. 19, 2013, directed to U.S. Appl. No. 12/716,515; 20 pages.
- Gammack, P. et al., U.S. Office Action mailed Dec. 9, 2010, directed to U.S. Appl. No. 12/716,781; 17 pages.
- Gammack, P. et al., U.S. Final Office Action mailed Jun. 24, 2011, directed to U.S. Appl. No. 12/716,781; 19 pages.
- Gammack et al. Office Action mailed May 29, 2013, directed towards U.S. Appl. No. 13/588,666; 11 pages.
- Gammack, P. et al., U.S. Office Action mailed Apr. 12, 2011, directed to U.S. Appl. No. 12/716,749; 8 pages.
- Gammack, P. et al., U.S. Office Action mailed Sep. 1, 2011, directed to U.S. Appl. No. 12/716,749; 9 pages.
- Gammack, P. et al., U.S. Office Action mailed Jun. 25, 2012, directed to U.S. Appl. No. 12/716,749; 11 pages.
- Fitton et al., U.S. Office Action mailed Mar. 30, 2012, directed to U.S. Appl. No. 12/716,707; 7 pages.
- Gammack et al., U.S. Office Action mailed Mar. 14, 2013, directed to U.S. Appl. No. 12/716,740; 15 pages.
- Gammack, P. et al., U.S. Office Action mailed May 24, 2011, directed to U.S. Appl. No. 12/716,613; 9 pages.
- Gammack, P. et al. U.S. Office Action mailed Oct. 18, 2012, directed to U.S. Appl. No. 12/917,247; 11 pages.
- Wallace et al., Office Action mailed Jun. 7, 2013, directed towards U.S. Appl. No. 13/192,223; 30 pages.
- Reba, I. (1966). "Applications of the Coanda Effect," *Scientific American* 214:84-92.
- Third Party Submission Under 37 CFR 1.99 filed Jun. 2, 2011, directed towards U.S. Appl. No. 12/203,698; 3 pages.
- Staniforth et al., U.S. Office Action mailed Sep. 18, 2014, directed to U.S. Appl. No. 13/559,142; 18 pages.
- Gammack et al., U.S. Office Action mailed Sep. 6, 2013, directed to U.S. Appl. No. 12/716,740; 15 pages.
- Gammack et al., Office Action mailed Sep. 27, 2013, directed to U.S. Appl. No. 13/588,666; 10 pages.
- Wallace et al., Office Action mailed Oct. 23, 2013, directed to U.S. Appl. No. 13/192,223; 18 pages.
- Gammack, P. et al., U.S. Office Action mailed Feb. 10, 2014, directed to U.S. Appl. No. 12/716,515; 21 pages.
- Fitton et al., U.S. Office Action mailed Dec. 31, 2013, directed to U.S. Appl. No. 13/718,693; 8 pages.
- Staniforth et al., U.S. Office Action mailed Jun. 4, 2015, directed to U.S. Appl. No. 13/784,430; 17 pages.
- Dyson et al., U.S. Office Action mailed May 28, 2015, directed to U.S. Appl. No. 29/460,993; 9 pages.
- Staniforth et al., U.S. Office Action mailed Mar. 17, 2015, directed to U.S. Appl. No. 13/785,787; 18 pages.
- Staniforth et al., U.S. Office Action mailed Feb. 27, 2015, directed to U.S. Appl. No. 13/786,014; 7 pages.
- Dyson et al., U.S. Office Action mailed Apr. 24, 2015, directed to U.S. Appl. No. 29/460,990; 6 pages.
- Dyson et al., U.S. Office Action mailed Apr. 10, 2015, directed to U.S. Appl. No. 29/460,989; 7 pages.
- Fitton et al., U.S. Office Action mailed Jun. 13, 2014, directed to U.S. Appl. No. 13/274,998; 11 pages.
- Fitton et al., U.S. Office Action mailed Jun. 13, 2014, directed to U.S. Appl. No. 13/275,034; 10 pages.
- Gammack et al., U.S. Office Action mailed Sep. 3, 2014, directed to U.S. Appl. No. 13/861,891; 7 pages.

* cited by examiner

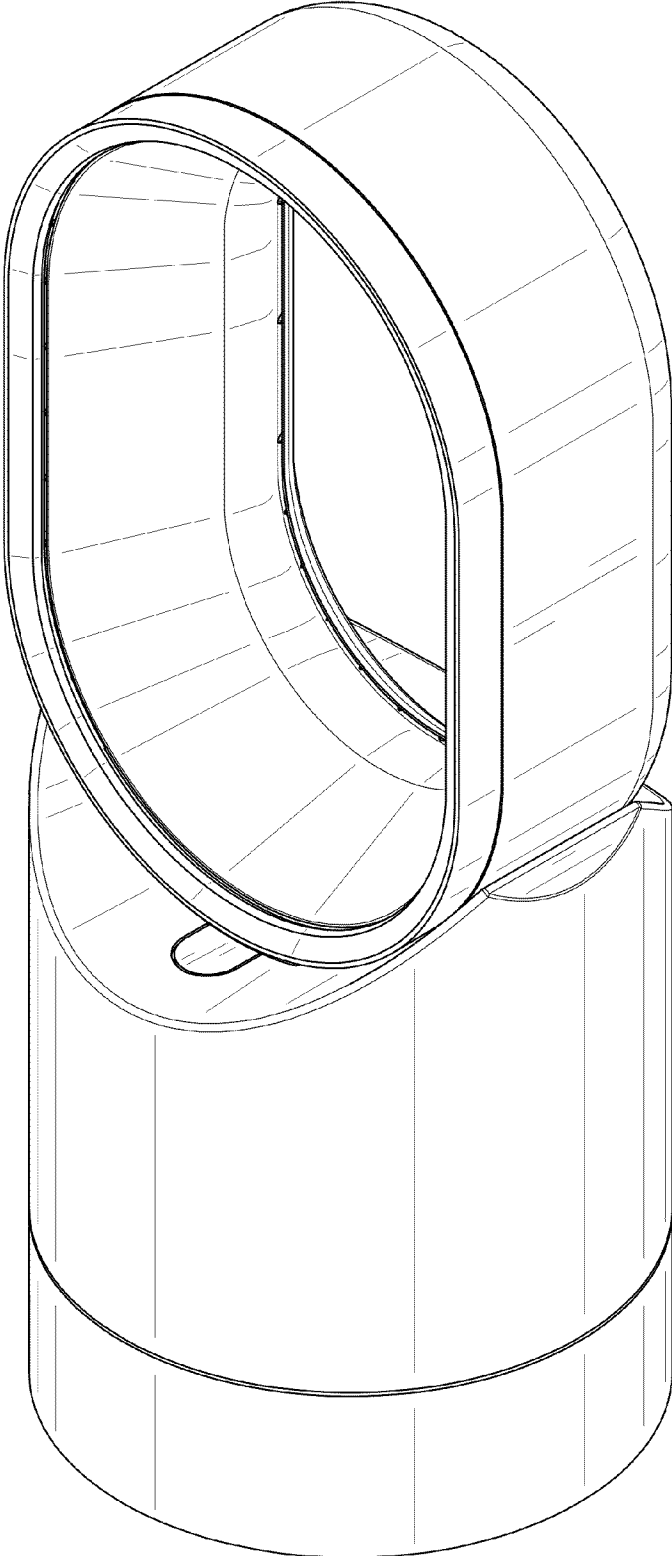

FIG. 1

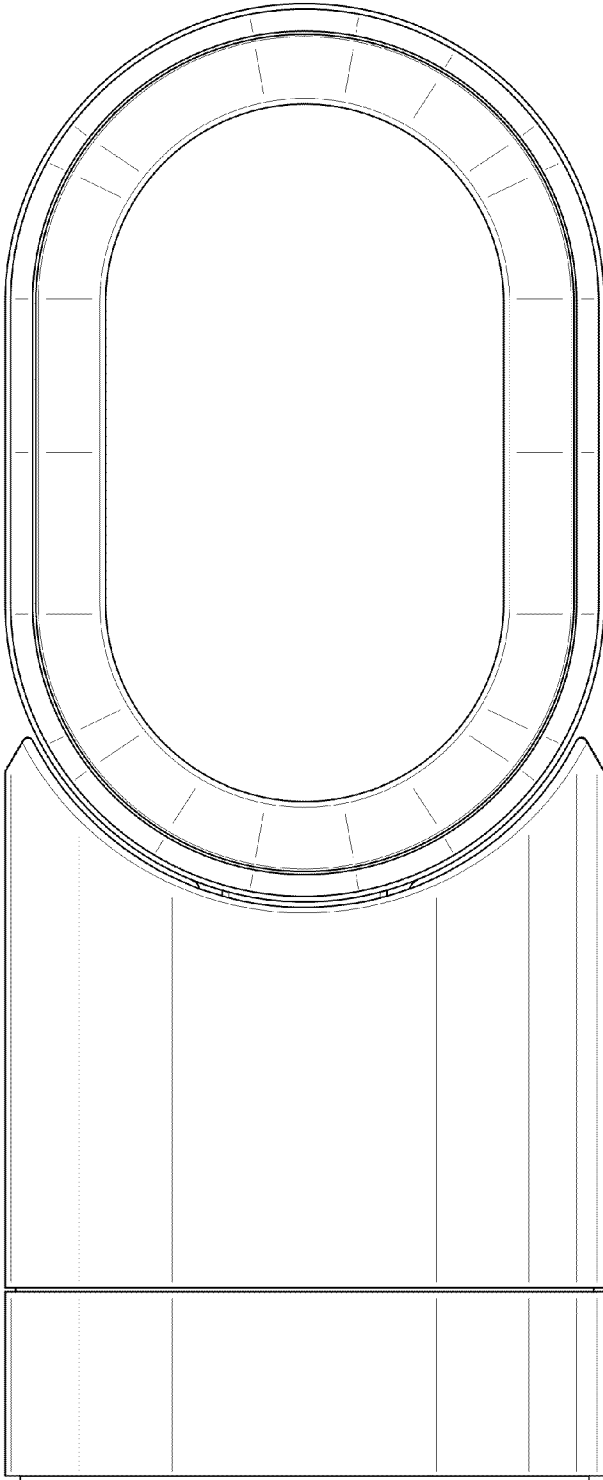

FIG. 2

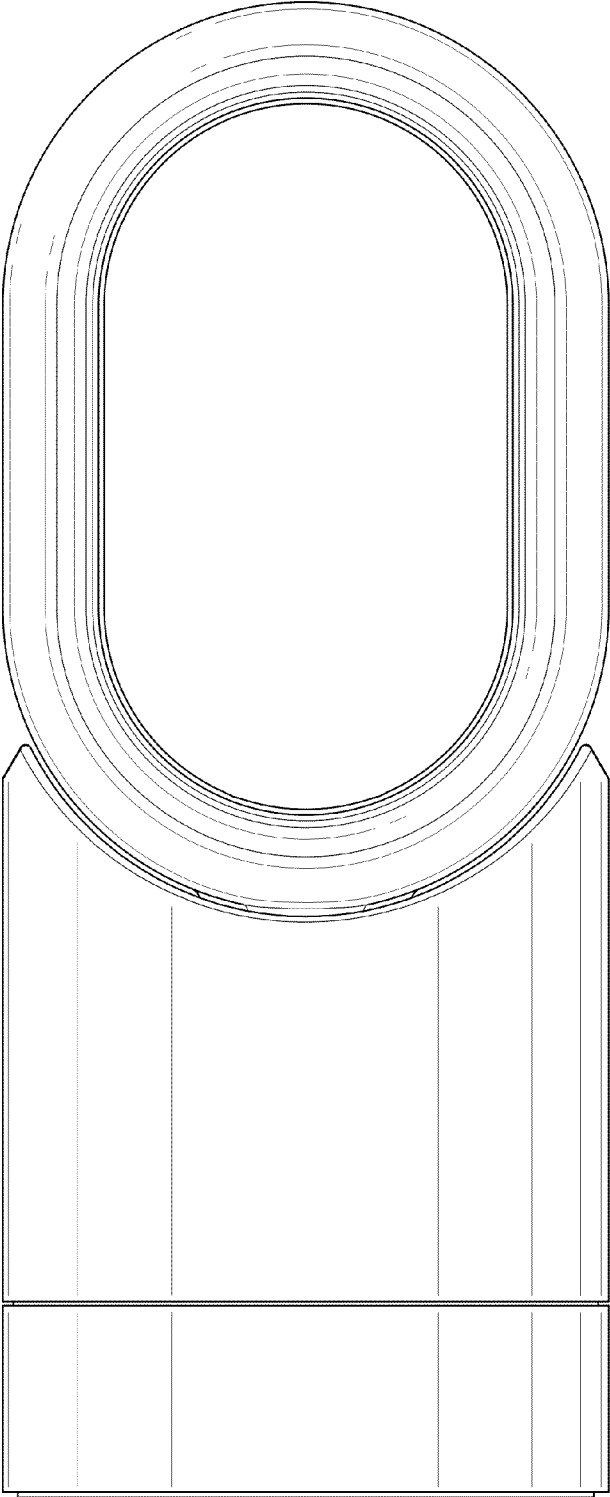

FIG. 3

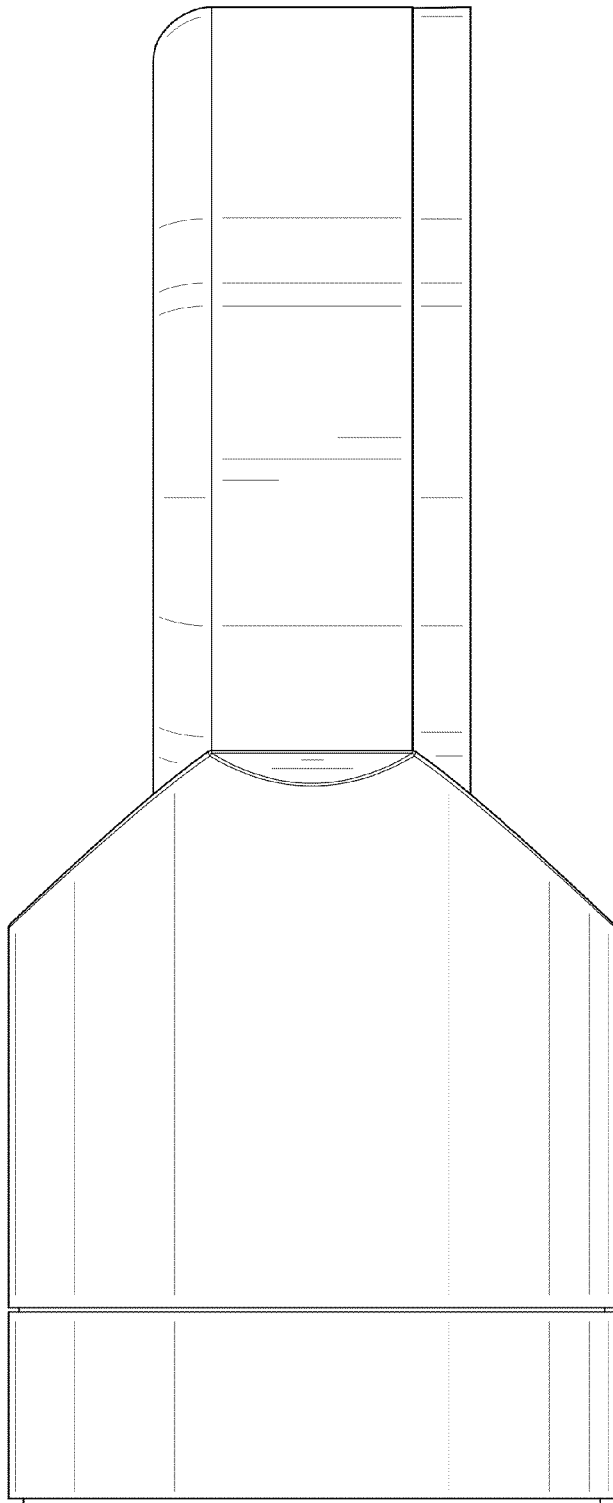

FIG. 4

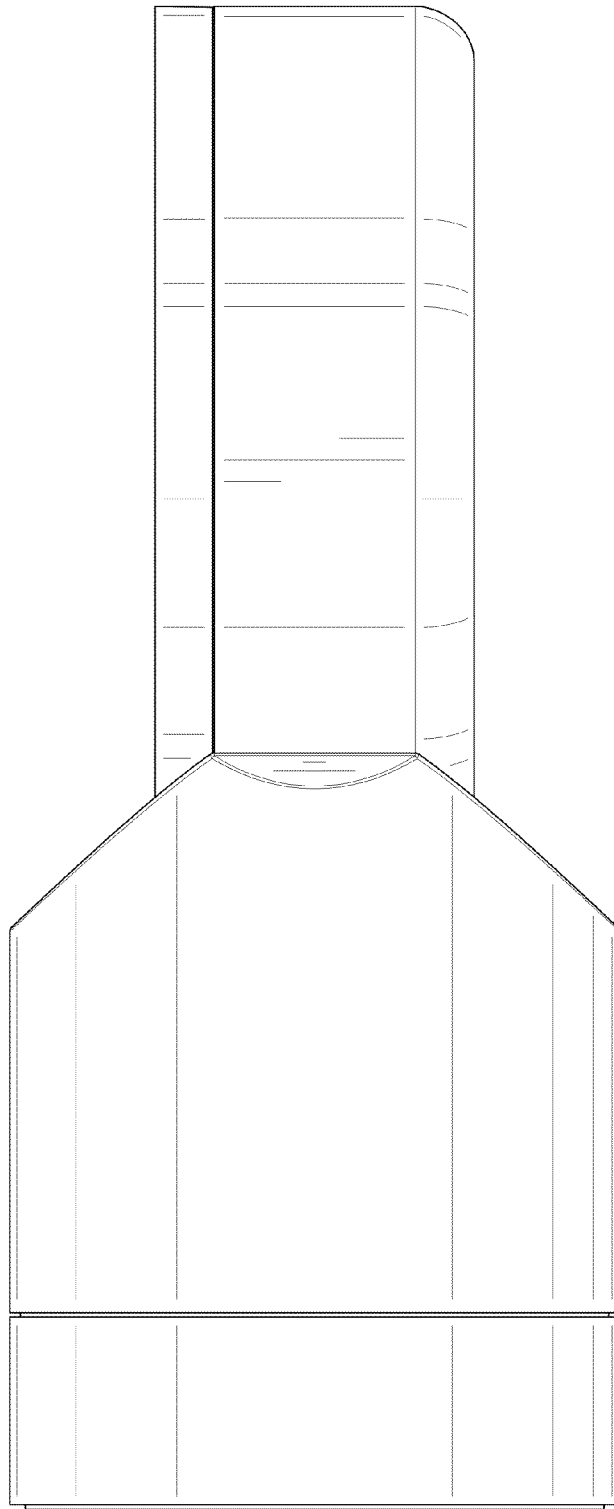

FIG. 5

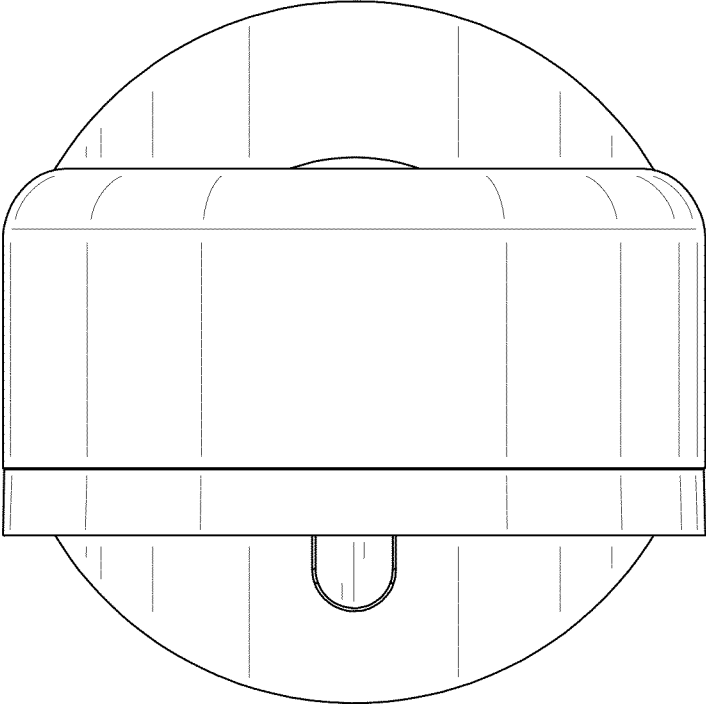

FIG. 6

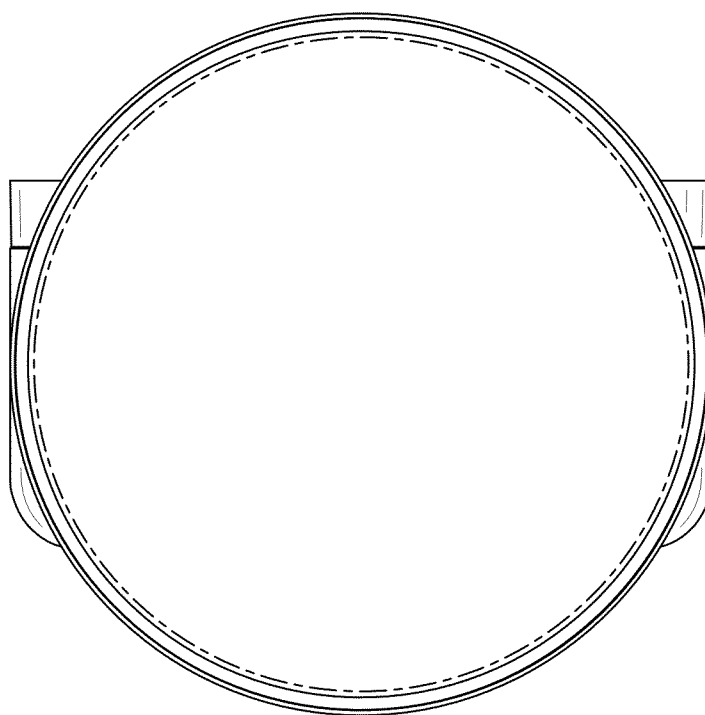

FIG. 7