



US00D771534S

(12) **United States Design Patent**
Bucher et al.

(10) **Patent No.:** **US D771,534 S**

(45) **Date of Patent:** **** Nov. 15, 2016**

(54) **VEHICLE FRONT LOWER GRILLE AND BUMPER COVER**

(71) Applicant: **Ford Global Technologies, LLC,**
Dearborn, MI (US)

(72) Inventors: **George Bucher,** Dearborn, MI (US);
Dean Carbis, Bloomfield Hills, MI (US)

(73) Assignee: **Ford Global Technologies, LLC,**
Dearborn, MI (US)

(**) Term: **15 Years**

(21) Appl. No.: **29/543,678**

(22) Filed: **Oct. 27, 2015**

(51) **LOC (10) Cl.** **12-08**

(52) **U.S. Cl.**
USPC **D12/169**

(58) **Field of Classification Search**
USPC D12/86-92, 163-172; 293/102-155;
296/35.2, 193.09, 193.1, 203.02
CPC B60R 19/02; B60R 19/023; B60R 19/18;
B60R 19/24; B60R 19/44; B60R 19/48;
B60R 19/56; B60R 2019/527; B60R
2019/1886

See application file for complete search history.

(56) **References Cited**

U.S. PATENT DOCUMENTS

D570,751 S	*	6/2008	Choi	D12/169
D580,318 S		11/2008	Gueler et al.		
D634,680 S	*	3/2011	Iida	D12/169
D634,681 S	*	3/2011	Hirabayashi	D12/169
D644,963 S		9/2011	Tonello		
D644,964 S		9/2011	Tonello		
D644,970 S		9/2011	Messale		
D647,435 S		10/2011	Tonello		
D650,725 S		12/2011	Tonello		
D664,481 S	*	7/2012	Platto	D12/163
D669,003 S	*	10/2012	Koizumi	D12/169

D670,624 S	*	11/2012	Koehl	D12/169
D692,798 S	*	11/2013	Thurber	D12/91
D703,118 S	*	4/2014	Gueler	D12/169
D703,593 S	*	4/2014	Gueler	D12/173
D727,211 S	*	4/2015	Rupar	D12/91
D727,221 S	*	4/2015	Rupar	D12/163

(Continued)

FOREIGN PATENT DOCUMENTS

EP 40201100581.6 2/2011

OTHER PUBLICATIONS

Wendler, Andrew. "2017 Ford Escape Debuts, Cranks up the Technology." caranddriver.com. Nov. 2015. Accessed Aug. 2, 2016. Available online at URL: <<http://www.caranddriver.com/news/2017-ford-escape-official-photos-and-info-news>>.*

(Continued)

Primary Examiner — Cathron Brooks

Assistant Examiner — Christian P McLean

(74) *Attorney, Agent, or Firm* — Damian Porcari

(57) **CLAIM**

The ornamental design for a vehicle front lower grille and bumper cover, as shown and described.

DESCRIPTION

FIG. 1 is a bottom front perspective and left view of the vehicle front lower grille and bumper cover, showing our new design;

FIG. 2 is a bottom front perspective and right view thereof;

FIG. 3 is a top rear perspective view thereof;

FIG. 4 is a front elevational view thereof;

FIG. 5 is a rear elevational view thereof;

FIG. 6 is a left side elevational view thereof;

FIG. 7 is a right side elevational view thereof;

FIG. 8 is a top plan view thereof; and,

FIG. 9 is a bottom plan view thereof.

1 Claim, 9 Drawing Sheets

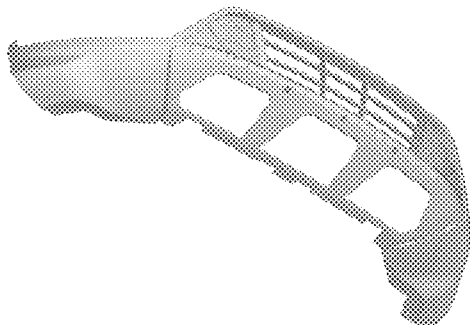

(56)

References Cited

U.S. PATENT DOCUMENTS

D727,224	S	*	4/2015	Wolff	D12/169
D731,371	S	*	6/2015	Morikawa	D12/169
D736,120	S	*	8/2015	Blanski	D12/91
D740,184	S	*	10/2015	Blanski	D12/163
D741,223	S	*	10/2015	Kim	D12/91

OTHER PUBLICATIONS

“2017 Ford Escape—Interior and Exterior Walkaround.” YouTube.com. 0:37. Published Nov. 16, 2015. Accessed Aug. 2, 2016. Available online at URL: <<https://www.youtube.com/watch?v=gvqk88X6vow>>.*

Bob Nagy <http://www.kbb.com/car-news/all-the-latest/2017-Ford-escape-spied/2000012056> 2017 Ford Escape spied, dated May 15, 2015.

Mark McNabb <http://www.topspeed.com/trucks/truck-reviews/Ford/2017-Ford-escape-ar169435.html> 2017 Ford Escape dated May 18, 2015.

Alexander Stoklosa <http://www.caranddriver/news/2017-Ford-escape-spy-photos-news> 2017 Ford Escape Spy Photos dated May 2015.

Unknown <http://www.autoblog.com/2015/06/25/2017-Ford-escape-spy-shots> New Ford Escape spied inside and out dated Jun. 25, 2015.

* cited by examiner

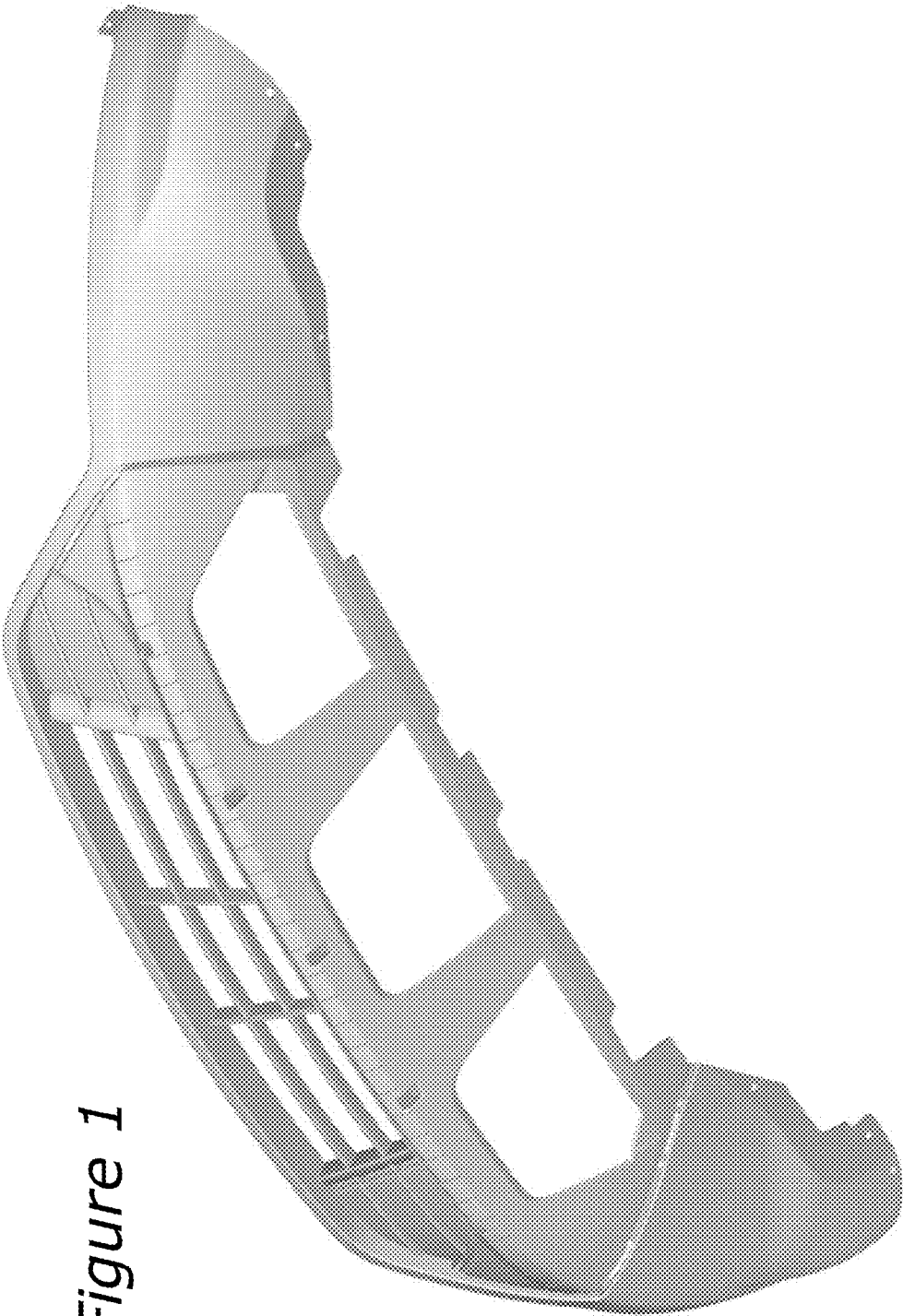

Figure 1

Figure 2



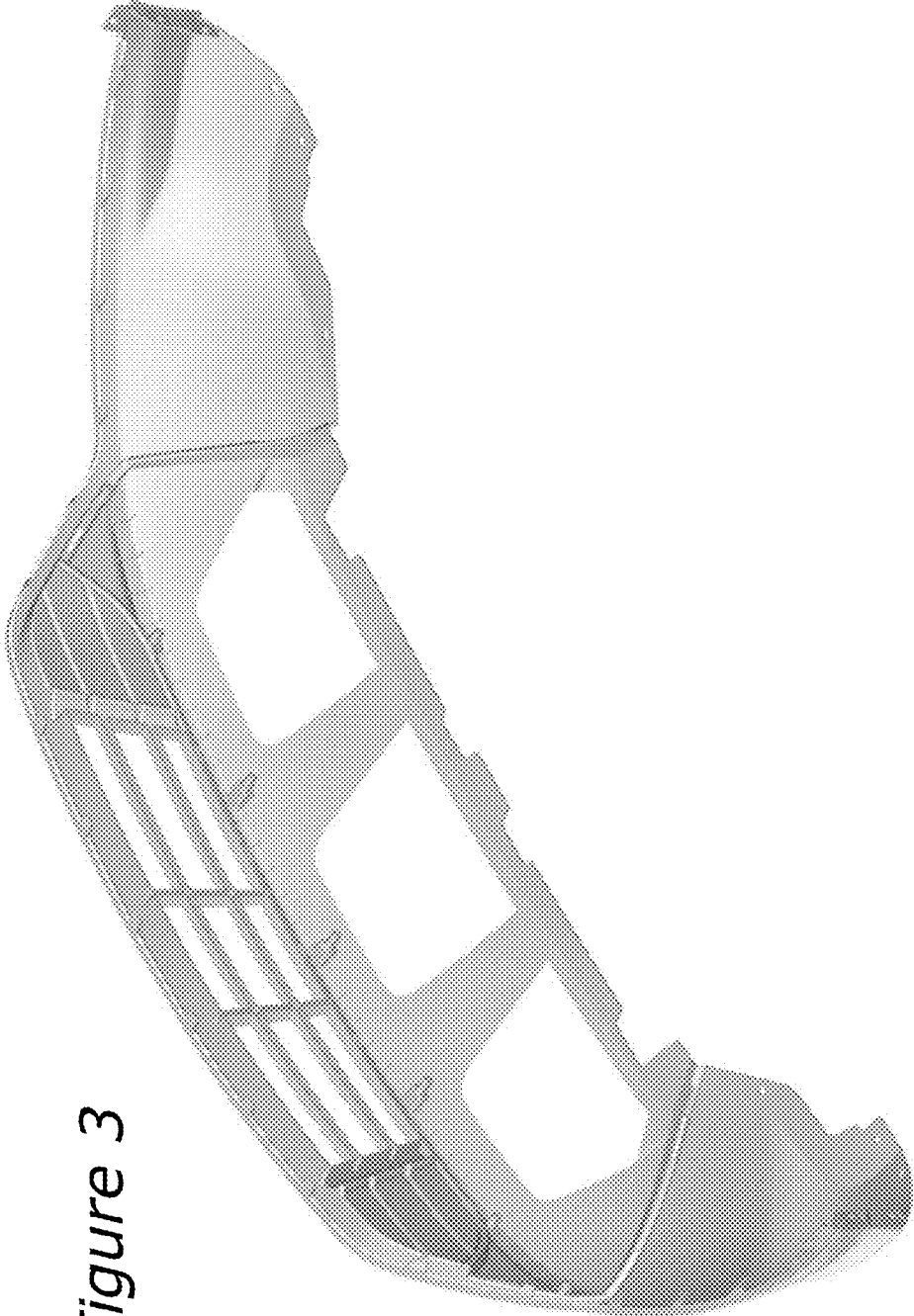

Figure 3

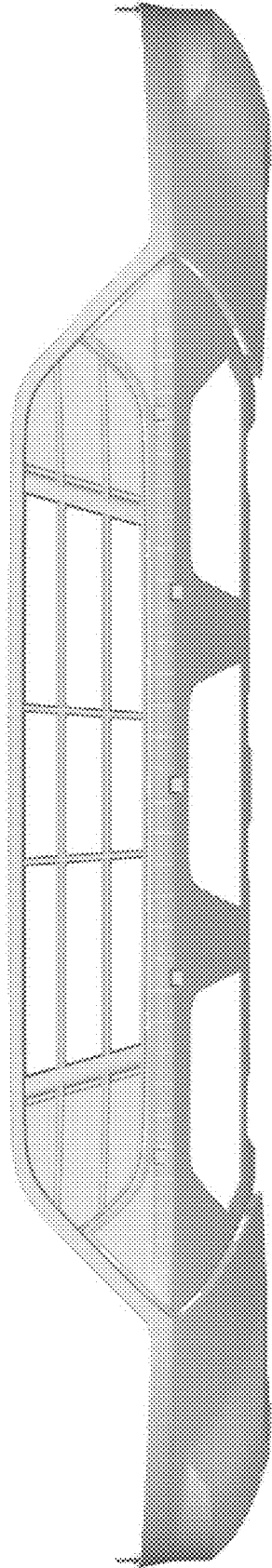

Figure 4

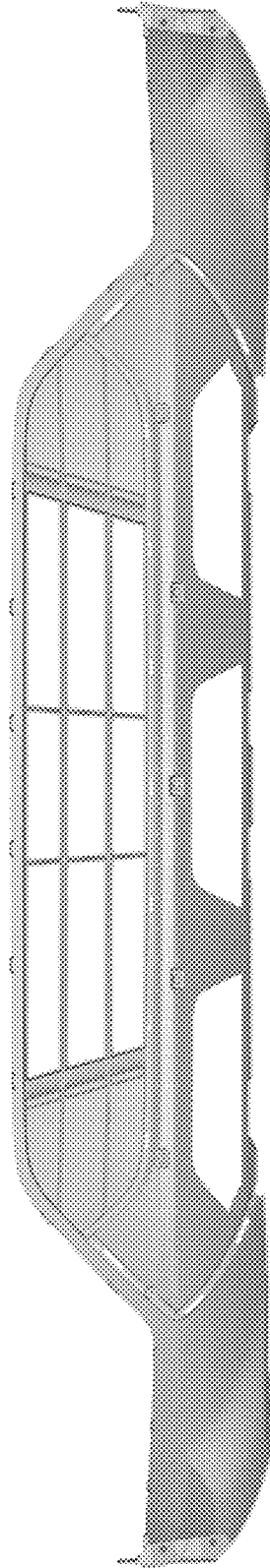

Figure 5

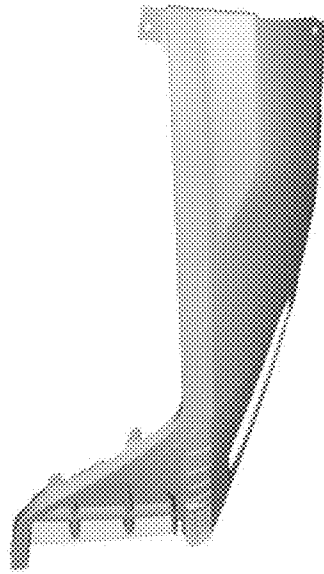

Figure 6

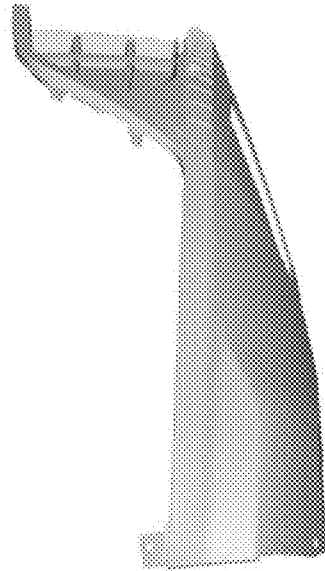

Figure 7

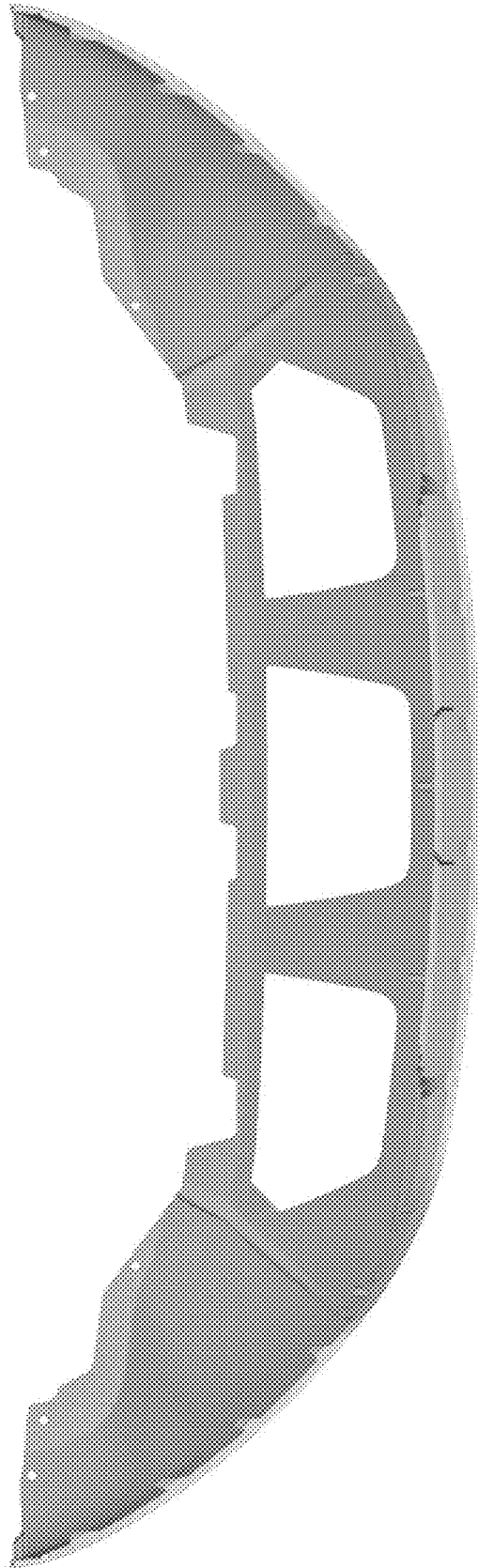

Figure 8

Figure 9

