



US00D854392S

(12) **United States Design Patent**
Watson et al.

(10) **Patent No.:** **US D854,392 S**

(45) **Date of Patent:** **** Jul. 23, 2019**

- (54) **FOLDABLE BLADE SHARPENER**
- (71) Applicant: **ACME UNITED CORPORATION**,
Fairfield, CT (US)
- (72) Inventors: **Stanley A. Watson**, Franklin, MA (US);
Richard S. Constantine, Monroe, CT (US)
- (73) Assignee: **ACME United Corporation**, Fairfield, CT (US)
- (**) Term: **15 Years**
- (21) Appl. No.: **29/629,501**
- (22) Filed: **Dec. 13, 2017**
- (51) **LOC (11) Cl.** **08-05**
- (52) **U.S. Cl.**
USPC **D8/93**
- (58) **Field of Classification Search**
USPC D8/63, 90, 91, 92, 93
CPC B24B 3/54; B24B 3/36; B24B 3/58; B24B 3/00; B24B 23/08; B24B 15/00; B24B 15/06; B24B 15/063; B24B 15/08
See application file for complete search history.

- D602,199 S * 10/2009 Ortega D28/21
- 8,973,273 B2 * 3/2015 Brown B25G 3/38
30/153
- D727,691 S * 4/2015 Wang D7/644
- D728,856 S * 5/2015 Wang D28/23
- D731,278 S * 6/2015 Cavanaugh D8/105
- D804,272 S * 12/2017 Chalfant D8/91
- D825,310 S * 8/2018 Liu D8/99

OTHER PUBLICATIONS

Bonytek folding sharpener found on Amazon.com.*

* cited by examiner

Primary Examiner — Philip S Hyder
(74) *Attorney, Agent, or Firm* — Bond Schoeneck & King, PLLC; George R McGuire

(57) **CLAIM**

The ornamental design for a foldable blade sharpener, as shown and described.

DESCRIPTION

FIG. 1 is a perspective view of a new and ornamental design for a foldable blade sharpener shown in its open position; FIG. 2 is a first side elevation view thereof; FIG. 3 is a second side elevation view thereof; FIG. 4 is a top plan view thereof; FIG. 5 is a bottom plan view thereof; FIG. 6 is a front elevation view thereof; FIG. 7 is a rear elevation view thereof; and, FIG. 8 is a second perspective view thereof with the foldable blade sharpener shown in its closed position.

1 Claim, 5 Drawing Sheets

(56) **References Cited**

U.S. PATENT DOCUMENTS

- 3,942,394 A * 3/1976 Juranitch B24D 15/06
76/84
- 4,259,815 A * 4/1981 Kuban B24D 15/08
451/552
- 4,271,592 A * 6/1981 Hoptner B26B 1/02
30/153
- D372,180 S * 7/1996 Powell D8/91
- D487,494 S * 3/2004 Glesser D22/118
- D493,684 S * 8/2004 Smith D8/90

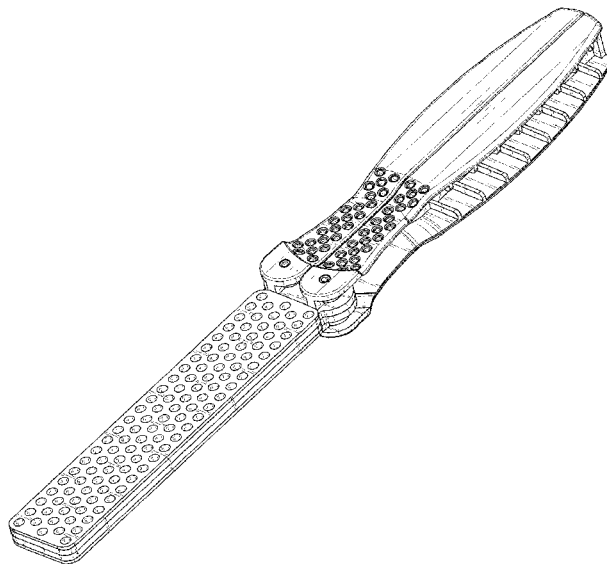

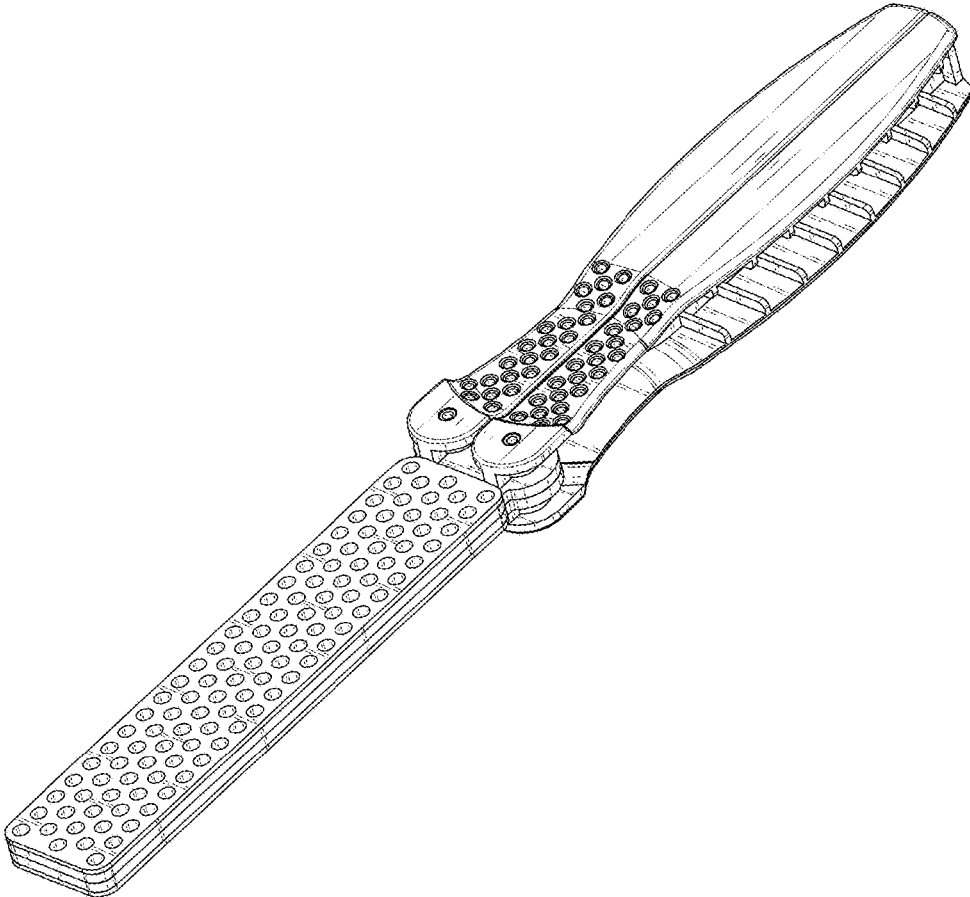

FIG. 1

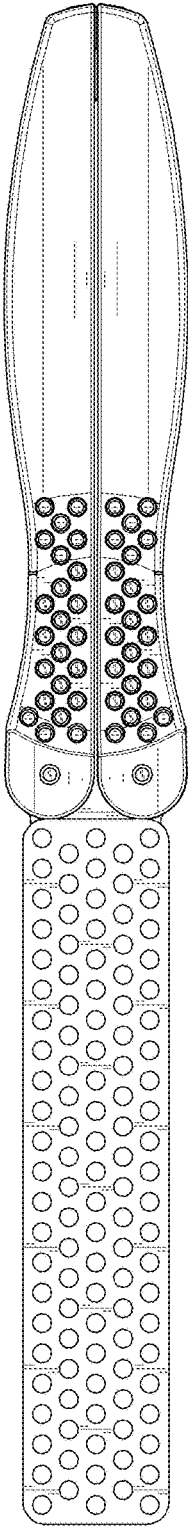

FIG. 2

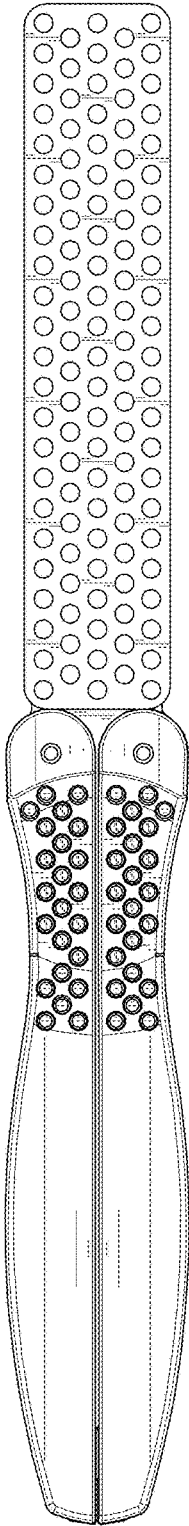

FIG. 3

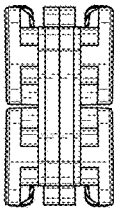

FIG. 4

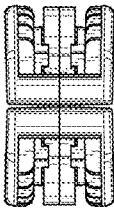

FIG. 5

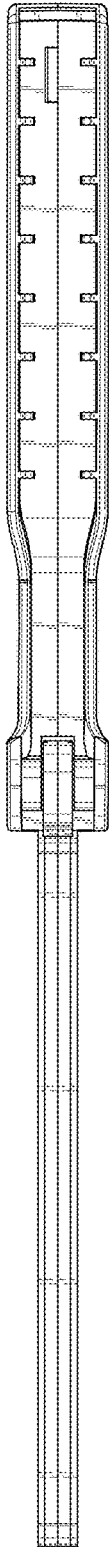

FIG. 6

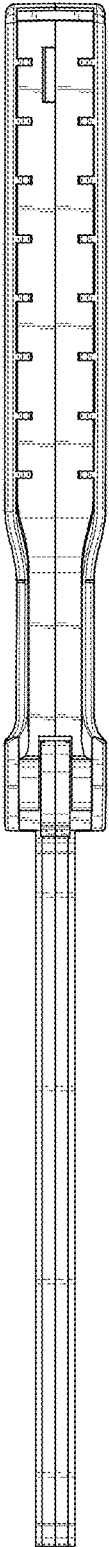

FIG. 7

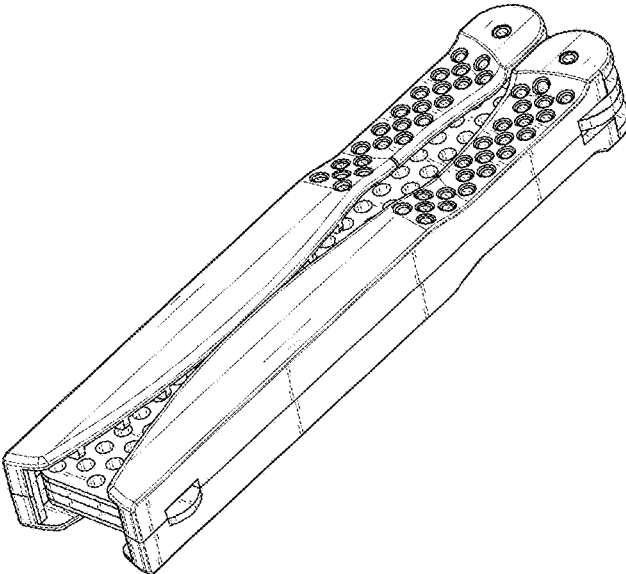

FIG. 8