

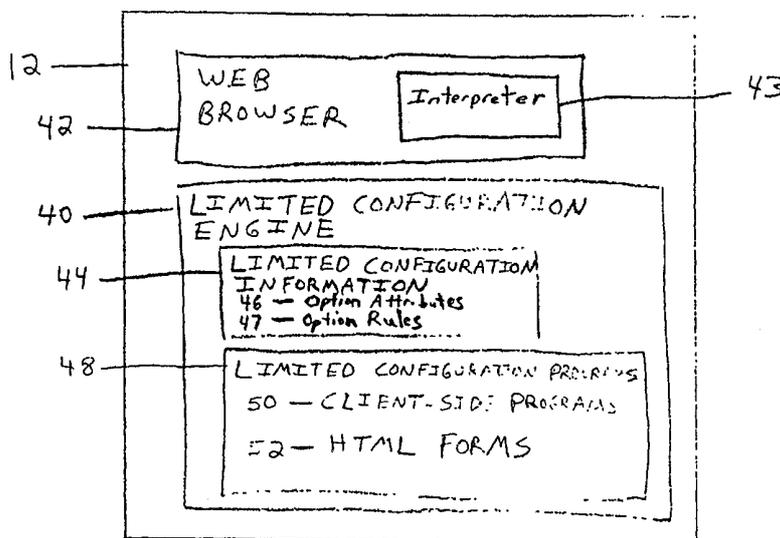

INTERNATIONAL APPLICATION PUBLISHED UNDER THE PATENT COOPERATION TREATY (PCT)

<p>(51) International Patent Classification ⁷ : G06F 15/16, 15/76</p>	<p>A1</p>	<p>(11) International Publication Number: WO 00/58854 (43) International Publication Date: 5 October 2000 (05.10.00)</p>
<p>(21) International Application Number: PCT/US00/08292 (22) International Filing Date: 29 March 2000 (29.03.00) (30) Priority Data: 09/280,609 29 March 1999 (29.03.99) US (71) Applicant: G.E. CAPITAL FLEET SERVICES [US/US]; Three Capital Drive, Eden Prairie, MN 55344 (US). (72) Inventors: BARCK, David; 4242 Zenith Avenue South, Minneapolis, MN 55410 (US). BENTLEY, Forrest; 445 32nd Avenue South, Minneapolis, MN 55406-3820 (US). HENNELLY, Kevin; 48 Groveland Terrace #207, Minneapolis, MN 55403 (US). (74) Agents: HAAG, Joseph, F. et al.; Dorsey & Whitney LLP, Pillsbury Center South, 220 South Sixth Street, Minneapolis, MN 55402-1498 (US).</p>		<p>(81) Designated States: AL, AM, AT, AU, AZ, BA, BB, BG, BR, BY, CA, CH, CN, CU, CZ, DE, DK, EE, ES, FI, GB, GD, GE, GH, GM, HR, HU, ID, IL, IN, IS, JP, KE, KG, KP, KR, KZ, LC, LK, LR, LS, LT, LU, LV, MD, MG, MK, MN, MW, MX, NO, NZ, PL, PT, RO, RU, SD, SE, SG, SI, SK, SL, TJ, TM, TR, TT, UA, UG, UZ, VN, YU, ZA, ZW, ARIPO patent (GH, GM, KE, LS, MW, SD, SL, SZ, TZ, UG, ZW), Eurasian patent (AM, AZ, BY, KG, KZ, MD, RU, TJ, TM), European patent (AT, BE, CH, CY, DE, DK, ES, FI, FR, GB, GR, IE, IT, LU, MC, NL, PT, SE), OAPI patent (BF, BJ, CF, CG, CI, CM, GA, GN, GW, ML, MR, NE, SN, TD, TG).</p> <p>Published <i>With international search report.</i></p>

(54) Title: A METHOD AND SYSTEM FOR DEVELOPING TECHNICAL CONFIGURATIONS



(57) Abstract

A method for developing a technical configuration and electronically delivering to a client (12) from a server (10) an order report (112b) for the technical configuration. The method comprises interactively eliciting and electronically receiving from a user on the client (12) a desired technical configuration, wherein the act of interactively eliciting and electronically receiving comprises providing to the client (12) from the server (10) a limited configuration engine (40) and performing a first, limited check on the viability of the desired technical configuration on the client (12) using the limited configuration engine (40); performing a second, final check on the viability of the desired technical configuration using a full configuration engine (52) on the server (10); and, in response to the final check, preparing and outputting on the client (12) an electronic report.

FOR THE PURPOSES OF INFORMATION ONLY

Codes used to identify States party to the PCT on the front pages of pamphlets publishing international applications under the PCT.

AL	Albania	ES	Spain	LS	Lesotho	SI	Slovenia
AM	Armenia	FI	Finland	LT	Lithuania	SK	Slovakia
AT	Austria	FR	France	LU	Luxembourg	SN	Senegal
AU	Australia	GA	Gabon	LV	Latvia	SZ	Swaziland
AZ	Azerbaijan	GB	United Kingdom	MC	Monaco	TD	Chad
BA	Bosnia and Herzegovina	GE	Georgia	MD	Republic of Moldova	TG	Togo
BB	Barbados	GH	Ghana	MG	Madagascar	TJ	Tajikistan
BE	Belgium	GN	Guinea	MK	The former Yugoslav Republic of Macedonia	TM	Turkmenistan
BF	Burkina Faso	GR	Greece			TR	Turkey
BG	Bulgaria	HU	Hungary	ML	Mali	TT	Trinidad and Tobago
BJ	Benin	IE	Ireland	MN	Mongolia	UA	Ukraine
BR	Brazil	IL	Israel	MR	Mauritania	UG	Uganda
BY	Belarus	IS	Iceland	MW	Malawi	US	United States of America
CA	Canada	IT	Italy	MX	Mexico	UZ	Uzbekistan
CF	Central African Republic	JP	Japan	NE	Niger	VN	Viet Nam
CG	Congo	KE	Kenya	NL	Netherlands	YU	Yugoslavia
CH	Switzerland	KG	Kyrgyzstan	NO	Norway	ZW	Zimbabwe
CI	Côte d'Ivoire	KP	Democratic People's Republic of Korea	NZ	New Zealand		
CM	Cameroon			PL	Poland		
CN	China	KR	Republic of Korea	PT	Portugal		
CU	Cuba	KZ	Kazakstan	RO	Romania		
CZ	Czech Republic	LC	Saint Lucia	RU	Russian Federation		
DE	Germany	LI	Liechtenstein	SD	Sudan		
DK	Denmark	LK	Sri Lanka	SE	Sweden		
EE	Estonia	LR	Liberia	SG	Singapore		

1 **Title: A Method and System For Developing Technical Configurations**

BACKGROUND OF THE INVENTION

1. Field of the Invention

This invention relates to computerized configuration methods and systems. More
6 particularly, this invention relates to computerized methods and systems for developing technical
configurations and electronically delivering order reports to a client. The methods and systems
are implemented in computer hardware and software.

2. Background Information

Large amounts of data and programs for a great variety of tasks are currently available
11 on the Internet. Some of these applications are useful for performing discrete logical tasks, while
others are available to retrieve data. Still other applications are available that may aid in the
selection and customization of products, such as vehicles or computers, or services, such as the
availability of flights and corresponding fare information. In these selection/customization tools
for products or services, the manufacturer of the product or the service provider may offer
16 detailed options for the user's selection, and a large number of interrelationships may exist
between the various options. When these options and interrelationships are complex, large and
detailed software may be necessary for electronic configuration systems.

The Internet is a collection of computer networks that allows computer users to share
files and other computer resources. Each computer connected to the Internet has a unique
21 address whose format is defined by the Internet Protocol ("TCP/IP"). The Internet includes a
public network using the TCP/IP and includes two kinds of computers: servers, which provide
information and documents; and clients, which retrieve and display documents and information
for users. Events that take place on the server machine are referred to as server-side activities,

-2-

- 1 while events that take place on the client machine are known as client-side activities. As will be appreciated by those of ordinary skill in the art, as used throughout this specification the term "client" refers to a client computer (or machine) on a network, or to a process or programs, such as Web browsers, which run on a client computer in order to facilitate network connectivity and communications. Thus, for example, a "client machine" can store one or more "client processes."
- 6 The term "user" is used to refer broadly to one or more persons who use a particular client machine. Similarly, the term "server" will be used throughout this specification to refer to a server computer or computer system on a network, or to a process or programs which run on a server computer.

The "World Wide Web" ("Web") is that collection of servers on the Internet that utilize

11 the Hypertext Transfer Protocol ("HTTP"). HTTP is a known application protocol that provides users access to resources, which may be information in different formats such as text, graphics, images, sound, video, Hypertext Markup Language ("HTML"), as well as programs. HTML is a standard page description language which provides basic document formatting and allows the developer to specify "links" to other servers and files. Links may be specified via a

16 Uniform Resource Locator ("URL"). Upon specification of a link by the user, the client makes a TCP/IP request to a Web server and receives information, which may be another "Web page" that is formatted according to HTML, from a server that was specified in the requested URL. The information returned to the client may be generated in whole or in part by a program that executes on the server. Such programs are typically Common-Gateway-Interface scripts ("CGI

21 scripts") and can be written using known programming languages or methods that the server supports, such as PERL or C++.

1 Servers include both Web servers and applications servers. Web servers are the
software or computers responsible for accepting requests from clients and retrieving the
specified file or specified CGI script, and returning its contents or the CGI script's results to the
client. An application server is the actual software or computer which contains programs, CGI
6 scripts, or data for a specific site. Servers run on a variety of platforms, including UNIX
machines, although other platforms, such as Windows 95, Windows NT, and Macintosh may
also be used.

Computer users can view information available on servers or networks on the Web
through the use of browsing software, such as Netscape Navigator, Microsoft Internet Explorer,
Mosaic, or Lynx browsers. A typical Web page is an HTML document with text, "links" that a
11 user may activate (e.g. "click on"), as well as embedded URLs pointing to resources, such as
images, video or sound, that the client may activate to fully use the Web page in a browser. In
some situations, these resources may not be located on the same server that provided the
HTML document to the client. Furthermore, HTTP allows for the transmission of certain
information from the client to a server. This information can be embedded within the URL, can
16 be contained in HTTP header fields, or can be posted directly to the server using other known
HTTP methods.

Web activity begins on the client side, when a user sends a request to a server over the
Internet. When a user's browser requests information from a server, the server may send
information including graphics, instruction sets, sound and video files in addition to HTML
21 documents (Web pages) to the requesting client. In order to view and use information from the
Web using a browser, the entire HTML document must be downloaded from the Internet server

1 to the client's machine and then processed by the browser before the consumer can fully see and
access it. A user may become impatient waiting for a graphics-oriented Web page or detailed
data to appear on his/her computer screen. Information delivery on the Internet can be
frustrating, because it is much slower than delivery of data from the consumer's computer hard
drive or main memory.

6 In a server-side application, the client must repeat the process described above, sending
a request to a server over the Internet and receiving information from the server in return, in
order for the client to interact with a server over the Internet. For instance, a user may supply
information in response to queries in a Web page. When the client clicks on a "submit" button,
which initiates interaction over the Internet, the information is passed to the server. As explained
11 above, programs such as CGI scripts may process the information, and the server may then
return a Web page containing the information requested by the user.

The Web page received by the client from the server may create or set an ID field,
known as a "client ID" or "cookie," located in a file on the client machine to include information
about the user's preferences. When the user later returns to a specified URL on the same
16 server, the "client ID" or "cookie" with the previously-set preference information is transmitted in
the HTTP request header to the server, which may then return a Web page that is assembled
according to the user-specific information. This interactive model for processing information
over the Internet is a server-side application, in which most of the logic and data processing is
performed on the server side.

21 A second possible interactive model is to deliver applications directly from the server to
the user's browser, where they are executed on the client machine. These applications are

-5-

1 typically small tools that perform simple tasks on the client computer, including a variety of
HTML page display enhancements. In the typical server-side system described above, servers
perform most of the computational work on the Web, and Web browsers may be little more
than glorified terminals. With so-called "applets" that run within a Web browser to process
information and other client-side programs, Web technology is shifted more toward the client,
6 relieving some of the computational load from the server. Applets may be used for a variety of
functions, and an applet may be a full-fledged program that can perform any number of
computational and user-interactive tasks on the client computer. For instance, an applet might
create a unique set of menus, choices, text fields, and similar user-input tools different from those
available through the browser. A number of different languages can be used for client-side
11 programs and applets, such as Java, ActiveX, JavaScript, Helper-Viewer, and other plug-ins.
Client-side JavaScript, for instance, is a commonly used programming language that may be
embedded into HTML Web pages and allows executable content, as opposed to data, to be
distributed over the Internet. JavaScript also has a limited ability to interact with the user.

There are problems associated with both client-side and server-side computational and
16 interactive systems. If a client-side approach is used, a large amount of time and/or bandwidth
may be used sending information to the client, a majority of which may not be necessary to the
end result desired by the user. When a large amount of time is spent transferring data over the
Internet, this may not only be annoying to the user, but it may also clog the network with
unnecessary data transfer. Additionally, only a limited amount of space in the memory of the
21 client is available. In view of these constraints, client-side programs are typically only used for
simple validations of information entered by the user or to generate graphic effects on the client.

1 Large tasks requiring extensive processing (by reason of large executable files or extensive data files, or both) are usually not performed on the client. One result of this may be that interface and options offered to the client are limited. The client's sense of control over the transaction may therefore be less than desired.

Server-side programs may also have undesirable attributes. Much like client-side
6 systems, a large amount of time may be spent transferring data to and from the server. In a pure server-side system, each time a user performs an operation on the client machine, a request is sent to the server to validate the request and perform an operation for transfer back to the client. A great deal of time may therefore be spent on the network validating information and processing data on the server. Such a system puts a heavy load on the server. In addition to
11 these drawbacks, the user may be annoyed by the large amount of time necessary to interact with the server and update information on the client machine.

It is therefore important to allocate appropriately the processing load and data transfers between the browser and the server. Some tasks, such as forms processing and index searches may be better left to the server side, while others, such as user interface enhancements, real-time
16 data presentation, and input validation may be better suited for local processing on the client. A system and method is needed for interactive network applications to reduce the load on a server, reduce the amount of time required to transfer information over the network, and to save the user time in performing tasks over the network.

Such a system and method may be particularly useful for complex technical configuration
21 tasks in which large amounts of both logic and data may be necessary to successfully configure a product or service. For such technical configuration tasks, a number of constraints or desirable

1 system attributes exist. First, the user's desired configuration must be viable, meaning that the manufacturer or service provider can assemble the various options desired by the user into a product. Second, it is desirable to indicate the price of the fully assembled configuration at the time of the order. Third, it is desirable to present all or most of the available options for a given product to a user on the client machine.

6 For some technical configuration tasks, such as products where manufacturers offer detailed option choices for configuration, configuring the product may be further complicated by the complex interrelationships and links between different options. Although in some configuration tasks it would be desirable to provide at the client an environment that is as option-rich as possible, technical limitations are encountered that limit the amount of logic and data that
11 may be transferred to the client. For complex configuration tasks, the transmission of all of the logic to the client may be both time consuming and impractical due to memory space; on the other hand, a pure server-side embodiment may require a large amount of interaction between the server and the client as well as a heavy load on the server.

SUMMARY OF THE INVENTION

16 One embodiment of the invention is a method for developing a technical configuration and electronically delivering to a client from a server an order report for the technical configuration. The method comprises interactively eliciting and electronically receiving from a user on the client a desired technical configuration, wherein the act of interactively eliciting and electronically receiving comprises providing to the client from the server a limited configuration
21 engine and performing a first, limited check on the viability of the desired technical configuration on the client using the limited configuration engine; performing a second, final check on the

1 viability of the desired technical configuration using a full configuration engine on the server; and,
in response to the final check, preparing and outputting on the client an electronic order report.

A second embodiment of the invention is a method for creating technical configurations and electronically delivering order reports to at least one client in a computer network having at least one server connectable to at least one client. The method comprises interactively eliciting
6 from a user on the at least one client a desired subset of possible products having technical configurations; in response to the user's desired subset of possible products having technical configurations, downloading from the at least one server to the at least one client limited configuration information and limited configuration programs; interactively eliciting from the user on the at least one client a desired technical configuration and preliminarily checking at the at
11 least one client the viability of the desired technical configuration using the limited configuration information and the limited configuration programs; uploading the desired technical configuration from the at least one client to the at least one server and performing a full check on the viability of the desired technical configuration using full configuration information and full configuration programs on the at least one server; and, responsive to the full check, preparing and outputting
16 on the at least one client an electronic order report.

Another embodiment of the invention is a method for creating vehicle configurations and electronically delivering order reports to at least one client in a computer network having at least one server connectable to at least one client. The method comprises interactively eliciting from a user on the at least one client a desired make, model, and series for a vehicle; in response to the
21 user's desired make, model, and series for a vehicle, downloading from the at least one server to the at least one client limited configuration information and limited configuration programs;

- 1 interactively eliciting from the user on the at least one client a desired vehicle configuration and
preliminarily checking at the at least one client the viability of the desired vehicle configuration
using the limited configuration information and the limited configuration programs; uploading the
desired vehicle configuration from the at least one client to the at least one server and performing
a full check on the viability of the desired vehicle configuration using full configuration information
6 and full configuration programs on the at least one server; and, responsive to the full check,
preparing and outputting on the at least one client an electronic order report.

The above methods offer a number of advantages. Because limited configuration
information and limited configuration programs are sent to the client, the client is able to do a
significant amount of the processing involved in creating a technical configuration. At the same
11 time, interaction with the server may be decreased. In addition, the data downloaded to the
client is properly allocated so that not all of the configuration information or configuration
programs that exist on the server are sent to the client. The above methods aid in the allocation
of information to the client. The client, therefore, is not overloaded with processing, and data
transfer time is kept to a minimum.

16 Another embodiment of the invention is a method for developing a product configuration
in a client-server environment, wherein the server has full option attributes and full option rules.
The method in this embodiment comprises receiving initial product configuration data from a user
on a client; in response to the initial product configuration data, allocating limited option attributes
and limited option rules to the client by downloading such limited option attributes and limited
21 option rules to the client; receiving from the client a first proposed product configuration
developed from client processing of the limited option attributes and limited option rules; in

1 response to the proposed product configuration and application at the server of the full option attributes and full option rules to the proposed product configuration, allocating and downloading to the client additional option rules; and, receiving from the client a second proposed product configuration developed from client processing of the limited option attributes and additional option rules.

6 One advantage of the above method is that data is properly allocated between the client and the server. Limited option attributes and limited option rules are sent from the server to the client, so the client is able to do a significant amount of the processing involved in creating a technical configuration. In addition, the data downloaded to the client is properly allocated so that not all of the full option attributes and full option rules that exist on the server are sent to the
11 client. The client, therefore, is not overloaded with processing, and data transfer time is kept to a minimum. After a full check of the viability of the proposed product configuration is determined on the server, additional option rules may be sent to the client from the server so that the user may properly configure the product.

Another embodiment of the invention comprises an apparatus for creating technical
16 configurations and electronically delivering order reports to at least one client in a computer network having at least one server connectable to at least one client. In this embodiment, the apparatus comprises a limited configuration engine, wherein the limited configuration engine is downloaded from the at least one server to the at least one client in response to data elicited from the at least one client, and wherein the limited configuration engine contains programs to
21 interactively elicit from a user a desired configuration to be uploaded to the at least one server,

- 1 and a full configuration engine on the at least one server, wherein the full configuration engine contains instructions for performing a full check on the viability of the desired configuration.

Yet another embodiment of the invention comprises a computer-readable medium whose contents cause a computer system to perform a procedure for developing a product configuration in a client-server environment, the computer-readable medium having client

- 6 programs and server programs with functions for invocation. In this embodiment, the computer-readable medium allows for the interactively eliciting from a user on the client a desired subset of possible products having technical configurations, in response to the user's desired subset of possible products having technical configurations, downloading from the server to the client limited configuration information and limited configuration programs, interactively eliciting from
- 11 the user on the client a desired technical configuration and preliminarily checking at the client the viability of the desired technical configuration using the limited configuration information and the limited configuration programs, uploading the desired technical configuration from the client to the server and performing a full check on the viability of the desired technical configuration using full configuration information and full configuration programs on the server, and responsive to the
- 16 full check, preparing and outputting on the client an electronic order report.

Much like the methods of the invention above, the above apparatus and computer-readable medium properly allocate data and information between the server and the client. The limited configuration engine which is sent to the client contains enough data to allow the user to enter a desired configuration, yet a full configuration engine exists on the server to ensure that the

- 21 desired configuration is viable. The client, therefore, is not overloaded with processing, and data transfer time is kept to a minimum.

1 Figure **11** is a diagram of a configuration summary page of a vehicle ordering
embodiment of the present invention.

DETAILED DESCRIPTION

The teachings of the present invention are applicable to many different types of computer
networks and may also be used, for instance, in conjunction with direct on-line connections to
6 databases. As will be appreciated by those of ordinary skill in the art, while the following
discussion sets forth various preferred implementations of the method and system of the present
invention, these implementations are not intended to be restrictive of the appended claims, nor
are they intended to imply that the claimed invention has limited applicability to one type of
computer network. In this regard, the teachings of the present invention are equally applicable
11 for use in Local Area Networks (“LANs”) of all types, Wide Area Networks (“WANs”),
private networks, and public networks including the Internet and the Web. While the principles
underlying the Internet and the Web are described in some detail above and below in connection
with various aspects of the present invention, this discussion is provided for descriptive purposes
only and is not intended to imply any limiting aspects to the broadly claimed methods and
16 systems of the present invention.

The accompanying Figures depict embodiments of the configuration systems and
methods of the present invention, and features and components thereof. With regard to
references in this specification to computers, the computers may be any standard computer
including standard attachments and components thereof (e.g., a disk drive, hard drive, CD
21 player or network server that communicates with a CPU and main memory, a sound board, a
keyboard and mouse, and a monitor). The processor of the CPU in the computer may be any

-14-

1 conventional general purpose single- or multi-chip microprocessor such as a Pentium®
processor, a Pentium® Pro processor, a 8051 processor, a MIPS® processor, a Power PC®
processor, or an ALPHA® processor. In addition, the processor may be any conventional
special purpose processor such as a digital signal processor or a graphics processor. The
microprocessor has conventional address lines, conventional data lines, and one or more
6 conventional control lines. With regard to references to software, the software may be standard
software used by those skilled in the art or may be coded in any standard programming language
to accomplish the tasks detailed below.

a. General Overview

Figure 1 is a block diagram illustration of the environment of the present invention, which
11 is a computer network based on a client-server model. The network comprises one or more
servers 10 which are accessible by one or more clients 12, such as personal computers. (For
simplicity, Figure 1 shows only one server 10 and one client 12.) The servers 10 communicate
with the clients 12 over a communication path 20, which may be a Local Area Network (LAN),
Wide Area Network (WAN), direct dial connection, the Internet, or other suitable
16 telecommunications path. A suitable network protocol, such as the TCP/IP protocol, may be
used for the communications. As described above, the servers 10 may comprise Web servers
14 and application servers 16, and may be any computer known to those skilled in the art.
Although Figure 1 depicts a Web server 14 and an application server 16 as separate entities,
these two servers 14, 16 may exist within a single computer or computer system, which,
21 throughout this specification, will be referred to as server 10. The server 10 allows access by
the clients 12 to various network resources. As shown in Figure 1, a firewall 5 may exist

1 between the Web server 14 and application server 16 of the server 10. Such firewalls 5 are
known to those skilled in the art and may be used to prevent unwanted access to the application
server 16.

1. The Client-Side

Figure 2 is a block diagram of a representative client computer 12. As described above,
6 the client 12 may be any conventional computer known to those skilled in the art. The client 12
comprises a processor or CPU and main memory 22, an input / output interface 24 for
communicating with various databases, files, programs, and networks, and one or more storage
devices 26. The storage devices 26 may be disk drive devices or CD ROM devices. The client
12 may also have a monitor 28 or other screen device, a printer or other output device 30, and
11 in input device 32 such as a keyboard. As is well known in the art, the computer 12 executes
programs stored on a data storage medium, which may be either a memory system of the client
12 or a persistent storage device 26, such as a disk or CD ROM system, so as to carry out the
functions of the present invention.

Figure 3 is a block diagram illustrating various programs or software which may run on
16 the client 12 when it will be used for configuration tasks. Although these programs are listed as
separate entities in Figure 3, these programs may be included within one software module which
may collectively be referred to as software or a software program. In one embodiment, these
programs as well as the programs on the server, the functions of which will be described in more
detail below, may be contained on a computer-readable medium, such as a standard floppy
21 disk. In an embodiment where the communication path 20 is the Internet or an Intranet, each of
the clients 12 may run a Web browser 42, which is a known software tool used to access the

1 Web via a connection obtained through an Internet access provider. A variety of browsers 42
known to those skilled in the art may be used within the scope of the present invention, including
Netscape Navigator, Microsoft Internet Explorer, or Mosaic browsers. In one embodiment, a
browser 42 that is capable of running client-side programs, such as JavaScript, may be used.
An interpreter 43 may exist either within the browser 42 or outside the browser 42 on the client
6 12. This interpreter 43 may be capable of interpreting or processing client-side programs within
the browser 42 so that the client-side programs may function within the browser 42. As
explained above, a Web server 14 may allow access to so-called "Web sites" and applications
available on application servers 16, as shown in Figure 1. As is also described above, the
location of a resource on a server 10 may be identified by a URL. The client 12 may also retain
11 a small "cookie," as defined in the background section, to retain state information regarding the
server 10 to which the client 12 exchanges requests.

Referring again to Figure 3, the client 12 may also contain other software or programs
which may reside in the main memory 22 of the client 12 or which may be persistently stored in
the storage device 26 of the client 12. A limited configuration engine 40 may reside on the client
16 12. This limited configuration engine 40 may contain limited configuration information 44 and
limited configuration programs 48. As will become clear in the following description, the limited
configuration engine 40 is a portion of a full configuration engine which resides on the server 10.
The role of the client 12 in the configuration systems and methods is to display screens, allow the
user to fill in information on the screens, perform limited, discrete logic tasks on the information
21 on the screens at the client 12 level, and to exchange data with the server 10.

1 The limited configuration information 44 is essentially a set of data for specifying a
particular product or service (throughout the remainder of this specification, the term product will
be used to refer to a product or service). For instance, the data may consist of a set of limited
option attributes 46 and limited option rules 47 for a given product. An option attribute 46 may
be a feature or option of a product, such as a type of engine or transmission in a vehicle along
6 with the corresponding price, from which a user chooses in configuring a product. The data may
also consist of a set of limited option rules 47 for a product. The option rules 47 consist of a set
of logic rules that links or defines relationships between certain of the option attributes 46. For
instance, if the configuration system and method is for a vehicle, a certain type of emissions
system or transmission may only be available for certain engine types, or certain interior color
11 schemes may only be available for certain exterior color packages. If A, B, and C are three
different option attributes 46 for a product or service, various option rules 47 may include, but
are not limited to, the following:

 if A, then B (meaning that if option attribute A is selected, then option attribute B is
automatically selected as well);

16 if A, then B optional (meaning that if option attribute A is selected, then option attribute
B is automatically selected as well, but it may be deselected);

 if A, not B (meaning that if option attribute A is selected, then option attribute B may not
be selected);

 if A and B, then C (meaning that if option attributes A and B are selected, then option
21 attribute C is automatically selected);

1 if A, then B or C (meaning that if option attribute A is selected, then option attribute B or
C must be selected).

Numerous other possible option rules 47 may also be used. Some of these additional option
rules 47 may be related to the price of the configuration as a whole. For instance, if option
attribute A is selected, then the user may get a discount on option attribute B or may get option
6 attribute B for no additional cost.

The limited configuration programs 48 of the limited configuration engine 40 may
comprise programs that perform such functions as processing the option attributes 46 and option
rules 47, performing the logic in the option rules 47, and formatting the layout of a Web page on
the client's monitor 28. If the Internet will be used with the configuration methods and systems,
11 the limited configuration programs 48 may comprise client-side programs 50, such as Java,
ActiveX, JavaScript, Helper-Viewer, and other plug-ins or other client-side programs, and
HTML forms 52. The client-side programs 50, which may be programs capable of running
within the browser 42 used with the invention, may process the option attributes 46 and option
rules 47 and run the logic for the processing on the client-side. The HTML forms 52 provide
16 basic Web page formatting that aids in the presentation of the Web page and allow the
developer to specify "links" to other servers 10 and files. Although the HTML forms 52 are
represented in Figure 3 as a part of the limited configuration programs 48, the HTML forms 52
may also reside within the limited configuration information 44. The distinction between that data
or those programs that reside within the limited configuration information 44 or the limited
21 configuration programs 48 is not important. This distinction is instead made merely by way of
example, and therefore does not limit the invention.

1 The limited configuration engine 40 may be downloaded from the server 10 to the client
12 in response to requests from the user or based on server 10 logic, both of which will be
explained in more detail below. Once resident on the client machine 12, the limited configuration
engine 40 may reside in memory 22 or within a storage device 26. In some cases, the client 12
may “cache” a limited configuration engine 40 or other resource obtained over the network so
6 that it is temporarily stored on the client machine 12 in either the main memory 22 or on disk or
on another storage device 26. The cached copy of the resource may then remain resident on the
client 12 for a defined period and may be easily accessed instead of obtaining it over the Internet
or network when the resource is needed at a later time. In such cases where cached programs
are used, neither the basic operations nor functions of the configuration systems and methods nor
11 the transmission of information to a server 10, differ from the cases where cached copies are not
used.

2. **The Server-Side**

Figure 4 illustrates in block form one embodiment of a portion of the contents of the
server 10 or, more particularly, the application server 16. The server 10 contains programs that
16 run on the server-side to process requests and responses from the client-side, send the proper
information to the client 12, and perform processes on the server-side. If the Internet is used
within an embodiment of the invention, these programs may be CGI scripts 62, as depicted in
Figure 4. Within the server 10, the full configuration engine 52 resides for each possible subset
of the full universe of possible products. Each subset may represent a different type of
21 configuration, and any number of subsets may be present on the server 10. For simplicity,
Figure 4 shows three subsets 50, 58, 60. For instance, if the configuration systems and methods

1 will be used for vehicle configurations, each subset may represent a different make, series, and
model of a vehicle. A different subset 50, 58, 60 would therefore exist for each different vehicle
model. If the configuration systems and methods will be used for computer configurations, each
subset may represent different manufacturers and type of computer, such as a laptop or desktop.
Although Figure 4 represents one possible embodiment of the organization of information within
6 the server 10, a variety of other organizational schemes known to those skilled in the art may
also be used. As shown in Figure 4, each subset 50, 58, 60 may contain the full configuration
engine 52 for one particular subset of the configuration system.

Referring now to Figure 5, the full configuration engine 52 for each subset 50, 58, 60
consists of the full configuration information 54 and full configuration programs 56 for that
11 particular subset. Within the full configuration information 64 are the full option attributes 65 and
the full option rules 66, which are similar in nature to the option attributes 46 and option rules 47
within the limited configuration information 44 on the client-side. The full option attributes 65
and full option rules 66 on the server-side, however, may contain more detailed rules that define
relationships among the option attributes 65 than those option rules 47 that reside on the client
16 12. Because the server 10 will likely not have the constraints on storage and processing of
detailed option rules as may the client 12, a full set of option rules 66 with corresponding
interrelationships between option attributes 65 may reside on the server 10. Within the full
option attributes 65 and full option rules 66 reside the limited option attributes 46 and option
rules 47 which may be downloaded to the client 12 during a configuration session.

21 The server 10 may receive the full option attributes 65 and full option rules 66 in a
variety of ways. In one embodiment, the technical information for the product or service may be

1 received in paper form from the manufacturer or dealer of the product or service, or from an
information provider that may receive and compile information for different technical products
and services. The full option attributes 65 and full option rules 66 may then be entered into the
system by human beings. In another embodiment, a manufacturer, dealer, or information
provider may transmit an electronic file which includes technical configuration information for a
6 product or service. This technical configuration information may then be electronically processed
and entered into the system as full option attributes 65 and full options rules 66.

The full configuration engine 52 on the server 10 also contains the full configuration
programs 68, which may include of the client-side programs 50 and HTML forms 52 which may
be sent to the client 12 as limited configuration programs 48 during a configuration session, as
11 well as server-side programs 70 which process the information and rules in the full configuration
engine 52 on the server 10. Although the client-side programs 50 and HTML forms 52 on the
server 10 may be the same versions as those downloaded to the client 12 during a configuration
session, the server-side programs 70, which may be CGI scripts as depicted as numeral 62 on
Figure 4, are not downloaded to the client 12, but instead reside and process logic and
16 information on the server 10.

As explained in the background section of this specification, it is generally desirable to
send only a limited amount of information to the client 12 due to data transfer time and client 12
response limitations. For this reason, only limited option rules 47 are sent to the client 12 in the
limited configuration information 44, while a full set of option rules 66 exist on the server 10. In
21 one embodiment, all of the option attributes 65 on the server 10 are transferred within the limited
configuration information 44 to the client 12, but less than all of the option rules 66 on the server

1 10 are sent to the client 12. In this embodiment, a set of the full option rules 66, which may be
much more complex than the option rules 47 sent to the client 12, resides only on the server 10.
The user on the client 12 in this embodiment, therefore, may be able to see each potential option
attribute 65 for a product, but not all of the links between each option attribute 65 and other
option attributes 65 will be present on the client 12. The user on the client 12, therefore, may be
6 able to select different option attributes 46 through an HTML Web page and certain of the
option rules 47 on the client 12 and client-side programs 50 may specify interrelationships
among the option attributes 46, yet a full application of the option rules 66 may be reserved for
the server-side.

b. Operation of the Invention

11 The operation of the configuration systems and methods will first be illustrated as a
broad application for any variety of product configurations in reference to Figures 6a-6c, and
then for a specific application to vehicle ordering methods and systems with reference to Figure
6a and Figures 7-10. Figures 6a-6c are block diagram overviews of three embodiments of the
methods and systems of the present invention which contains sections detailing the exchange of
16 information between the server 10 and the client 12. The server 10, which in one embodiment
may be an application server 16 as shown in Figure 1, contains the subsets 50, 58, 60 of full
configuration engines 52 as shown in Figures 4 and 5.

1. Tight Configuration Embodiment

Figure 6a shows a block diagram overview of information exchange in a tight
21 configuration embodiment of the present invention. This embodiment may be referred to as a

1 “tight” configuration embodiment because the user selects each selectable option until a viable configuration is assembled.

a. Subset Selection

To begin a configuration session, the user may access the page on the server 10 associated with the configuration system to initiate a session. In an embodiment of the invention using the Web, such a page may be an HTML Web page. A registration or enrollment session may require the user to submit certain information about himself or herself in order to use the configuration system. The server 10 may then send to the client 10 a variety of subset choices 100 of products from which to assemble a configuration. The subset choices 100 may be presented to the user on the client 10 through an HTML Web page on the client’s monitor 28.

6

11 Because a limited amount of space may be available in the main memory 22 of the client 12, the amount of information presented for each subset choice 100 may be limited to a discrete amount. As previously noted, each subset may represent a different make, model, or series of a product. After the user selects a desired subset 102, which may then be uploaded to the server 10 as shown in Figure 6a, a second set of subset choices 100 may be presented to the user to

16 further refine the subset choice 100 for a configuration session. In this manner, the exchange of subset choices 100 and desired subsets 102 between the client 12 and the server 10 may be repeated a number of times until a discrete amount of data for which the client 12 has space may be downloaded from the server 10 to the client 12. In a configuration system with only one or a few subset choices 100, these subset choices 100 may be presented to the user on the client 12

21 in one page, or may be intertwined with later pages described below which may be used to select option attributes 46 during a configuration session.

1 The user's desired subset 102 represents initial product configuration data, which the server 10 uses to allocate a limited configuration engine 40 to the client 12. Different limited configuration engines 40 will be downloaded to the client 12 from the server 10 for each different desired subset 102.

b. Preliminary Viability Check

6 After a small enough segment of data to operate a configuration session on the client 12 may be downloaded to the client 12, a limited configuration engine 40 (shown as numeral 104 in Figure 6a during transfer to the client 12 from the server 10) is downloaded to the client 12. As explained in connection with Figure 3, the limited configuration engine 40 may contain limited configuration information 44 and limited configuration programs 48. In one embodiment, the
11 limited configuration engine 40 contains HTML forms 52 for presentation of information on the client 12. The option attributes 46 of the limited configuration information 44 may therefore be presented to the user through a Web page, and the limited option rules 47 may perform some limited operations on the client 12. In one embodiment, one set of limited configuration programs 48 may be downloaded to the client and used with any given subset which the user
16 selects. In this embodiment, only the limited configuration information 44 would differ from one subset to another.

 The Web page presented to the user on the client 12 may interactively elicit information from the user through various interfaces known to those skilled in the art, such as drop-down boxes, scroll bars, or check boxes. As the user selects various option attributes 46 in the Web
21 page, the option rules 47 and the client-side programs 50 on the client 12 may update the screen to reflect the interrelationships of the various option attributes 46 selected. Thus, through the use

-25-

1 of Java, ActiveX, JavaScript, Helper-Viewer, or other plug-ins or client-side programs 50
known to those skilled in the art, in conjunction with the limited configuration information 44 and
limited configuration programs 48 available on the client 12, the user's choices may be
preliminarily checked for viability on the client machine 12. Because the information on the client
12 in the limited configuration engine 40 will be a truncated version of the full configuration
6 engine 52 on the server 10, the validity of the user's desired configuration may only be
preliminarily checked. In one embodiment, if a user's selection is not viable, the Web page will
not allow the user to select a certain option attribute 46. In addition, the Web page may update
the user after various choices on the client's monitor 28, so that information, such as an
approximate price of the product, may be updated dynamically on the client 12 as the user
11 configures a product by selecting option attributes 46.

In one embodiment, it is important to note that the limited configuration engine 40
downloaded to the client 12 (as shown as numeral 104 in Figure 6a) may contain a discrete
segment of information so that the user may make a variety of choices on a Web page, yet do so
without active interaction with the server 10. This offers the advantage of a limited amount of
16 time spent downloading information to and uploading information from the client 12. As the user
interacts with the Web page to select choices for a configuration, this limited processing and
checking may be done on the client 12 instead of on the server 10.

c. Full Viability Check

When the user has completed entering his or her desired configuration, the user can click
21 on the "submit" button to upload the desired configuration 106 to the server 10, as shown in
Figure 6a. This desired configuration 106 is the user's proposed product configuration, which,

-26-

1 though it has been preliminarily checked for viability using the limited option attributes 46 and
limited option rules 47 on the client 12, may not be viable when checked against the full option
rules 66 on the server 10. Because only a preliminary check of the user's desired configuration
106 was performed on the client 12 using the limited configuration engine 40, the complete
validity of the configuration may be determined on the server 10, which contains a full set of the
6 option rules 66 as well as server-side programs 70. The server 10 therefore determines the
viability of the desired configuration using the full configuration engine 52. As explained above,
this full configuration engine 52 may be a more complete and detailed version of the limited
configuration engine 40 on the client 12. For example, many of the interrelationships between
different option attributes may exist only on the server 10 due to limited space in the main
11 memory 22 of the client 12. In particular, full pricing information, which may be complex due to
package deals, discounts, and upgrade pricing deals, may reside only on the server 10.

In one embodiment, all option attributes for a given subset may be presented to the user
on the client 12, and it may be only a detailed processing of the user's desired configuration that
is uniquely carried out on the server 10, in part because the client-side programs 50 and option
16 rules 47 provided to the client 12 may not be sophisticated enough to carry out this processing
on the client 12 due to limited space. After the viability status of the desired configuration 106 is
determined at the server 10, the viability status of the configuration 108 may be downloaded to
the client 12 as shown in Figure 6a during transfer from the server 10 to the client 12.

If the desired configuration 106 is viable, an order report 112 may also be downloaded
21 to the client 12. This order report 112, which may be downloaded to the client 12 in place of or

-27-

1 in addition to the downloading of the viability of the configuration 108, may report the final price
of the configuration as well as a summary of each of the options selected by the user.

If the desired configuration 106 is not viable, the viability status of the configuration 108
sent from the server 10 to the client 12 may report the unresolved viability issues to the user on
the client 12. For instance, the Web page used for presenting the options to the user on the
6 client 12 may again be presented to the user on the client 12 with certain option attributes 46
highlighted with a note describing a problem with the desired configuration. Similarly, if the user
does not select a choice from certain option attributes 46 for which a selection is mandatory, the
user may be presented with a reminder to select one or more of those option attributes 46. In
one embodiment, if the desired configuration is not viable, the server 10 may download updated
11 limited configuration information 44 and updated limited configuration programs 48 to the client
12. The server 10, therefore, may allocate and download additional information to the client 12,
which may include additional limited option attributes 46 and limited option rules 47, so that the
user may assemble a viable configuration. In another embodiment, only additional option rules
47 may be allocated to the client 12 at this time. The updated limited configuration engine 40
16 may then be used on the client 12 by the user for entering a desired configuration.

In this manner, the user will be prompted to assemble a viable configuration on the client
12 through any number of communications with the server 10. This new desired configuration
110 may then be uploaded to the server 10. When such a viable configuration has been entered
by the user, submitted to the server 10, and approved as being viable by the server 10, an order
21 report 112 may be sent to the client 12.

1 The configuration methods and systems of the present invention may present any number
of Web pages with various option attributes 46 to the client 12 in the manner described above,
such that the acts described above may be repeated any number of times with different option
attribute choices until a full and viable configuration has been assembled. When such a full and
viable configuration has been assembled, an order 114 may be electronically sent from the server
6 10 to the manufacturer or service provider so that the configuration may be assembled or
ordered.

2. **Pre-Configuration Embodiment**

Figure 6b shows a block diagram overview of information exchange in a pre-
configuration embodiment of the present invention. Much like the tight configuration embodiment
11 described above, in this embodiment the server 10 may send to the client 12 a variety of subset
choices 100b of product embodiments from which to assemble a configuration. The user then
selects a pre-configuration option, as denoted by numeral 101 in Figure 6b. The subset choices
100b presented to the client 12, therefore, may allow the user to select the pre-configuration
embodiment in this embodiment. The pre-configuration option allows the user to select product
16 configurations which have already been configured, either in prior configuration sessions with the
user or by the server 10. For example, popular product configurations could be presented as
options to save the user time in configuring a product. In one embodiment, each new
configuration the user develops could be saved so that the user may later select it as a pre-
configured product.

21 After the pre-configuration data is uploaded to the server 10, the server 10 performs a
viability check on that data, much like described above for the tight configuration embodiment.

1 This information sent from the client 12 to the server 10, which may also be called initial product
configuration data, should typically result in a viable configuration in this embodiment, because a
pre-configured product has been chosen by the user. The pre-configuration option may,
however, only select some of the options of the product in one embodiment, such that the user
may still need to complete the configuration by selecting the rest of the options. Numeral 108b
6 in Figure 6b shows the server 10 downloading to the client 12 the viability of the pre-configured
product or further tools for configuration. For example, limited configuration information 44 and
limited configuration programs 48 may be downloaded to the client 12 so that the user can
complete the configuration or, if the configuration is not viable, select different options to
assemble a viable configuration. After the user has completed assembling a further desired
11 configuration (if needed because the pre-configured product is either not viable or is not
complete), this further desired configuration 110b is uploaded to the server 10. After any
number of iterations of the above described acts and after the server 10 finds a desired
configuration viable, an order report 112b may be sent to the client 12.

3. Loose Configuration Embodiment

16 Figure 6c shows a block diagram overview of information exchange in a loose
configuration embodiment of the present invention. This embodiment may be referred to as a
“loose” configuration embodiment because the user generally enters desired options in free text
form and the server 10 finds the closest viable configuration matching to those desired options.

Much like the embodiments described above, in this embodiment the server 10 may
21 send to the client 12 a variety of subset choices 100c of product embodiments from which to
assemble a configuration. The user then selects a loose fit option, as denoted by numeral 103 in

-30-

1 Figure 6c. The subset choices 100c presented to the client 12, therefore, may allow the user to select the loose fit embodiment in this embodiment. When the user selects the loose fit embodiment, the user may then enter in a dialog box presented to the user on the client 12 desired options in free text or other similar form. This loose fit information 103 is then uploaded to the server 10. In one embodiment, a human being processes the desired options to find the
6 closest viable configuration. In another embodiment, the server 10 processes the desired options and finds the closest viable configuration. In this embodiment, the server 10, therefore, may run a CGI script 62 using the full option attributes 65 and full options rules 66 to find the closest viable configuration.

Numeral 108c in Figure 6c shows the server 10 downloading to the client 12 the viability
11 of the desired configuration and, if needed, further configuration tools. In one embodiment, if a viable configuration may not be developed which is similar to the user's loose fit information, therefore, further configuration tools (in the form of a limited configuration engine 40) may be sent to the client 12 from the server 10. The user may then further develop the product configuration and a further desired configuration 110c may be uploaded from the client 12 to the
16 server 10. Eventually, after a viable configuration has been assembled through any number of iterations of the above acts, an order report 112c may be sent from the server 10 to the client 12.

c. **Vehicle Ordering Embodiment**

Figures 7-11 detail one embodiment of the configuration methods and systems described
21 above for vehicle configuration and ordering.

1 **1. Business Context**

As an introduction to a vehicle ordering system, Figure 7 illustrates the general business process of a vehicle ordering system showing the flow of information between four different entities: the user or client 12, the configuring party represented by the server 10, the manufacturer 180 of the vehicle, and the vehicle dealer 190. A configuration system operated
6 by a configuring party may be important and useful for a number of reasons. First, a configuring party may assist companies in developing and maintaining large or small fleets of vehicles through such systems. If a company has a large fleet of vehicles to maintain, a configuring party may be able to assist in record-keeping for the vehicles (such as for maintenance or license tab renewal), and may provide an interface between the company and vehicle dealers to simplify vehicle
11 configuration and ordering. Second, because a configuring party may be ordering large numbers of vehicles, the configuring party may get a discount on vehicle prices from the dealers. Finally, the configuring party may aid in the financing process for a company's fleet of vehicles, such that the fleet of vehicles may be financed or leased in the aggregate through the configuring party.

At step 200, the server 10 receives make and model information including details on
16 options for makes, models, and series, from the vehicle manufacturers 180. It is important to note that the manufacturer sets the options and interrelationships between options, including pricing, for various makes and models. The complexity of these options and interrelationships may make it impractical to perform all of the logic associated with a vehicle configuration on the client 12. This information may be updated periodically, as depicted in step 202, so that all of
21 the latest options may be available on the server 10. At step 204, the server 10 may send information to the client 12 regarding vehicle ordering. At block 206, the client 12 orders a

-32-

1 vehicle using a vehicle ordering system, which will be explained in greater detail below. At block
208, a vehicle price is delivered to the client 12 for such a vehicle, and the client 12 then reports
the decision back to the server 10 to order the vehicle at step 210. After the vehicle
configuration is delivered to the manufacturer at step 212, the status of the vehicle construction
and/or delivery is delivered to the server 10.

6 At step 216, the server 10 inquires with the dealer as to the delivery of the vehicle. A
contract may be delivered to the server 10 at step 218 and confirmation of the vehicle order may
be delivered to the dealer at step 220. At step 222, the status of the vehicle configuration may
be delivered to the server 10. At step 224, the vehicle is delivered to the dealer for delivery to
the client 12 at step 226. Finally, the client 12 may deliver an old vehicle to the dealer at step
11 228.

2. Vehicle Ordering System and Methods

Figure 8 details in block diagram form the flow of the vehicle configuration methods and
systems which may be used for developing a valid vehicle configuration and for ordering a
vehicle. At block 300, the user enters the vehicle configuration system to begin the configuration
16 process. Initially, the server 10 may download a variety of options to the client 12, including, as
depicted in Figure 8, a pre-configuration option 306 and the option for the user to select either a
loose match 304 or a tight match 302 of option attributes with viable vehicle configurations.
These three embodiments, which were described above in a general product configuration
embodiment, aid the server 10 in determining how much and which limited configuration engines
21 40 to download to the client 12 from the server 10.

-33-

1 If the user chooses a loose match 304 between the desired options and viable configurations, a freeflow text screen may be presented to the user at block 308 on the client 12 to enter desired vehicle option attributes in free text form. When the user clicks the submit button the desired configuration is uploaded to the server 10 (denoted by block 310 in Figure 8 and as the loose fit information 103 in Figure 6c). In one embodiment, the server 10 may

6 determine the closest match to the loose fit information 103 by performing a word matching analysis to find a close match. Further configuration tools may need to be presented to the user on the client 12 to further develop a configuration, as described above, such that any number of interactions with the server 10 may be necessary to develop a viable configuration. In another embodiment, a human being may process the desired option attributes to find the closest

11 possible match. As depicted at block 334 in Figure 8 and as the order report 112c in Figure 6c, an order report 112c may then be delivered from the server 10 to the client 12.

 In the typical scenario where a user desires to select all of the desired option attributes of a vehicle in the tight configuration embodiment (as in Figure 6a), the user may be prompted to select certain choices through HTML Web pages on the client 12. In this embodiment, the user

16 may first be prompted to select a make of a vehicle, as depicted in block 312 of Figure 8. Figure 9 illustrates one such HTML Web page in which a scroll box exists for the user to select a vehicle make 400. Figure 9 is shown by way of example only, and it is noted that more than one Web page could be used for the functions illustrated in Figure 9 and any form for this page known to those skilled in the art could be used. After the user selects a make 400 of vehicle,

21 that information may be uploaded to the server 10, which is denoted as block 314 in Figure 8. Figure 6a denotes this interaction between the client 12 and the server 10 by the uploading of a

1 desired subset 102 to the server 10. After the user selects a make 400 of vehicle and this
information is uploaded to the server 10, the server 10 may send another set of subset choices
100 to the client 12 so that the user may select a series of car. Figure 6a depicts the transfer of
these subset choices 100 from the server 10 to the client 12.

The user may then select a series of vehicle, as shown in scroll box 402 in Figure 9 and
6 block 316 in Figure 8. A similar procedure is then followed as when a make of vehicle was
selected by the user. The desired subset 102 is uploaded to the server 10, as shown in block
318 in Figure 8. The server 10, in turn, may then download additional subset choices 100 to the
client 12, as shown in Figure 6a. Similarly, the user may then select a model of vehicle, as
shown in scroll box 404 in Figure 9 and block 320 in Figure 8. This desired subset 102 may
11 then be uploaded to the server 10, as shown in Figure 6a and by block 322 in Figure 8. In this
manner, the user narrows the possible product configurations such that, upon receiving the
subset choices 100 (or initial product configuration data) the server 10 may allocate and
download an appropriate limited configuration engine 40 to the client 12.

Block 324 in Figure 8 depicts the process in which the user may select a variety of
16 options for the chosen make/series/model of vehicle selected. In order to present these option
attributes to the user on the client 12, the limited configuration engine 40 corresponding to the
make/series/model is downloaded to the client 12, which is depicted as numeral 104 in Figure
6a. As previously stated, the limited configuration engine 40 downloaded from the server 10 to
the client 12 is a limited version of the full configuration engine 52 on the server 10
21 corresponding to the particular make/series/model of the vehicle selected for configuration. In
one embodiment, this limited configuration engine 40 presents a full set of the option attributes to

-35-

1 the user on the client 12, but does not contain a full set of the option rules that exist on the server
10. Because there are a large number of option rules and interrelationships between option
attributes for vehicle configurations, a full set of these option rules remains on the server 10,
where a full and final check of the viability of the desired configuration may be performed. In
one embodiment, as the user selects option attributes, the price of the vehicle configuration may
6 be dynamically updated to reflect an approximate price of the vehicle as configured.

Figure 10 shows one potential embodiment of an HTML Web page which may be
presented to the user for selecting option attributes (block 324 in Figure 8), although any page
known to those skilled in the art may be presented to the user for this purpose. A number of
option attributes 500, 502, 504, such as the type of engine, axles, and other vehicle option
11 packages, may be presented for the user's choice. Figure 10 also shows the price 506 which
may be listed for each option attribute. As previously described in connection with the invention,
the limited configuration engine 40 and the Java, ActiveX, JavaScript, Helper-Viewer, or other
plug-ins or client-side programs 50 on the client 12 may perform a limited check on the viability
of a desired configuration as the user enters or chooses option attributes. For example, certain
16 option attributes 46 may be automatically selected or made not available for selection upon the
selection of other option attributes 46 by the user. When the user completes the desired
configuration, the user may click on the "submit" or "next" button, which uploads the desired
configuration from the client 12 to the server 10. This act of uploading the desired configuration
106 is shown in Figure 6a and is depicted as block 326 in Figure 8.

21 The server 10 performs a check on the viability of the desired configuration using the full
configuration engine 52. As indicated above, this full configuration engine 52 on the server 10

1 contains more detailed option rules 66 and full configuration programs 68 to check the viability of the desired configuration. If the desired configuration is viable, the server 10 may download another limited configuration engine 40 to the client 12 so that the user may select the desired color scheme for the vehicle, as indicated in block 330 in Figure 8. In one embodiment, this color selection page may be combined with the option selection page at block 324 of Figure 8.

6 In this embodiment, a separate page for the selection of a color scheme may not be necessary. In another embodiment, this color selection page may be a separate HTML form for which a separate process of uploading a desired color scheme to the server 10 may be necessary, which is indicated on Figure 8 as block 332.

If the desired configuration is viable, i.e., if the selected option attributes in the desired

11 configuration may be combined to form a valid vehicle configuration, the server 10 may download to the client 12 an order report 112 summarizing the selected configuration and/or a document detailing the viability of the desired configuration. If the desired configuration is not viable, i.e., where the full option rules are not met and option attributes must therefore be changed to build a viable configuration, the document detailing the viability of the desired

16 configuration may be a version of the HTML form used for option selection (as shown in Figure 10), with certain options highlighted or with explanations as to the necessity to change certain option attributes. A limited configuration engine 40, which may be similar to that transmitted to the client 12 as numeral 104 in Figure 6a, may also be downloaded to the client 12 as part of the viability of the configuration 108 to allow the user to refine the vehicle configuration. In this

21 manner, further configuration tools, such as additional limited option attributes 46 and limited

1 option rules 47, may be allocated and downloaded from the server 10 to the client 12 if a
desired configuration is not viable.

This process of uploading a desired configuration (numeral 106 in Figure 6a) from the
client 12 to the server 10 and downloading the viability status of the configuration and tools for
resolving open viability issues (numeral 108 in Figure 6a) may be repeated until a viable
6 configuration has been assembled and an order report 112 summarizing that configuration may
be downloaded to the client 12. Block 334 of Figure 8 and numeral 112 in Figure 6a represent
this order report which is downloaded from the server 10 to the client 12. Such an order report
or configuration summary may appear similar to the configuration summary depicted as Figure
11. Figure 11 shows a Web page illustrating a configuration summary and containing a total
11 invoice price 600, the make, model, and series of car 602, as well as a summary of the optional
equipment 604 (option attributes) for the vehicle. This Web page may be a one-page summary
or a multi-page summary showing the options for the vehicle configuration.

Figure 8 also depicts as block 306 the possibility that pre-configured vehicles may be
used to aid in the configuration process, which is shown in Figure 6b for a general product
16 configuration embodiment. A user, for example, may have one or more configurations that he or
she commonly uses. These configurations may be saved (on either the client 12 or the server
10) to be used later. In one embodiment, each time a user configures a vehicle, that
configuration may be saved for later use. Starting a configuration session with a pre-configured
or partially pre-configured vehicle may simplify the configuration process. Figure 8 illustrates
21 one scenario where the pre-configured information consists of the make/model/series information
for the vehicle, but the user still selects the options for that give make/model/series. A second

-38-

1 scenario shown in Figure 8 depicts the possibility that the options are also pre-configured for the
vehicle, so that only the color scheme must be selected by the user during a configuration
session.

After a configuration session has been completed and a viable configuration has been
assembled, an order may be sent from the server 10 to the vehicle manufacturer or vehicle
6 dealer to order the vehicle. This order is represented by numeral 114 in Figure 6a, Figure 6b,
and Figure 6c.

d. Summary

The present invention provides methods and systems for computerized configurations in
network systems containing one or more servers 10 and one or more clients 12. The methods
11 and systems allocate the load between the server-side and the client-side of such a network and
reduce the amount of time spent uploading or downloading information between the client 12
and the server 10. The systems and methods utilize existing computer systems and software
packages. The methods and systems accomplish these tasks by sending only a limited
configuration engine 40 from the server 10 to the client 12 to perform a discrete amount of logic
16 on the client 12. The user's interaction with the client 12, which may be through an HTML Web
page using client-side programs 50, will not require communication with the server 10 while the
user enters configuration options and limited logic is performed on those options. Because only
a limited configuration engine 40 is sent from the server 10 to the client 12, a final check on the
viability of the desired configuration may be performed on the server 10 after a desired
21 configuration is uploaded to the server 10 from the client 12.

1 The methods and systems of the present invention are particularly useful for technical and
complex configurations, such as vehicle or computer configurations, where a large number of
option attributes exist and a large number of option rules and interrelationships exist between
options. For such systems, it may be unpractical to transmit the full logic of the configuration
system from the server 10 to the client 12, yet it may be undesirable to have repeated
6 communications with the network as associated with common server-side systems. The
methods and systems of the present invention aid in the allocation of data and information
between the server 10 and the client 12, so that only a limited amount of information and data
will be downloaded to the client 12 from the server 10. The full data and information is retained
on the server 10 for a final check on the viability of desired configurations.

11 While the present invention has been described with reference to several embodiments
thereof, those skilled in the art will recognize various changes that may be made without
departing from the spirit and scope of the claimed invention. Accordingly, this invention is not
limited to what is shown in the drawings and described in the specification but only as indicated
in the appended claims. Any numbering or ordering of elements in the following claims is merely
16 for convenience and is not intended to suggest that the ordering of the elements of the claims has
any particular significance other than that otherwise expressed by the language of the claims.

1

CLAIMS

What is claimed is:

1. A method for developing a technical configuration and electronically delivering to a client from a server an order report for the technical configuration, the method comprising:
 - (a) interactively eliciting and electronically receiving from a user on the client a
6 desired technical configuration, wherein the act of interactively eliciting and electronically receiving comprises providing to the client from the server a limited configuration engine and performing a first, limited check on the viability of the desired technical configuration on the client using the limited configuration engine;
 - (b) performing a second, final check on the viability of the desired technical
11 configuration using a full configuration engine on the server; and
 - (c) in response to the final check, preparing and outputting on the client an electronic order report.
2. The method of claim 1 wherein the limited configuration engine comprises limited option attributes and limited option rules.
- 16 3. The method of claim 1 wherein the full configuration engine comprises full option attributes and full option rules.
4. The method of claim 1 wherein the act of providing a limited configuration engine comprises downloading configuration information and configuration programs from the server to the client.
- 21 5. The method of claim 1 further comprising receiving from an information provider an electronic file including technical configuration information.

- 1 6. The method of claim 1 further comprising uploading the desired technical configuration from the client to the server.
7. The method of claim 6 wherein the act of performing a second, final check further comprises finding an exact match between the desired technical configuration and a viable configuration.
- 6 8. The method of claim 1 wherein the act of interactively eliciting and electronically receiving further comprises enabling the user to specify whether an exact match or a loose match is desired between the desired technical configuration and a viable configuration.
9. The method of claim 1 wherein the act of interactively eliciting and electronically receiving on the client further comprises using templates of pre-configured information.
- 11 10. The method of claim 1 wherein the electronic order report includes pricing information.
11. In a computer network having at least one server connectable to at least one client, a method for creating technical configurations and electronically delivering order reports to at least one client, the method comprising:
- (a) interactively eliciting from a user on the at least one client a desired subset of
- 16 possible products having technical configurations;
- (b) in response to the user's desired subset of possible products having technical configurations, downloading from the at least one server to the at least one client limited configuration information and limited configuration programs;
- (c) interactively eliciting from the user on the at least one client a desired technical
- 21 configuration and preliminarily checking at the at least one client the viability of the desired

- 1 technical configuration using the limited configuration information and the limited configuration programs;
- (d) uploading the desired technical configuration from the at least one client to the at least one server and performing a full check on the viability of the desired technical configuration using full configuration information and full configuration programs on the at least one server; and
- 6 (e) responsive to the full check, preparing and outputting on the at least one client an electronic order report.
12. The method of claim 11 further comprising using a TCP/IP connection to pass an HTTP request from the client to the server.
13. The method of claim 11 wherein the limited configuration information comprises limited
- 11 option attributes and limited option rules.
14. The method of claim 11 wherein the limited configuration programs comprise an HTML page and client-side programs.
15. The method of claim 14 wherein the client-side programs comprise a plug-in or helper-application.
- 16 16. The method of claim 14 wherein the client-side programs include one or more programs selected from Java, JavaScript, ActiveX, and Helper-Viewer.
17. The method of claim 14 wherein the client-side programs are cached on the client.
18. The method of claim 17 wherein the client-side programs are cached in client-side memory.
- 21 19. The method of claim 17 wherein the client-side programs are cached on client-side disk storage.

- 1 20. The method of claim 11 wherein the act of performing a full check comprises executing a
CGI script on the server.
21. The method of claim 11 further comprising:
- (f) in response to the act of performing a full check on the viability of the desired
technical configuration on the at least one server, allocating and downloading to the at least one
6 client additional limited configuration information; and
- (g) receiving from the at least one client a second desired technical configuration
developed from client processing of the additional limited configuration information.
22. The method of claim 11 wherein the act of interactively eliciting and electronically
receiving further comprises enabling the user to specify whether an exact match or a loose match
11 is desired between the desired technical configuration and a viable configuration.
23. The method of claim 11 wherein the act of interactively eliciting and electronically
receiving on the client further comprises using templates of pre-configured information.
24. In a computer network having at least one server connectable to at least one client, a
method for creating vehicle configurations and electronically delivering order reports to at least
16 one client, the method comprising:
- (a) interactively eliciting from a user on the at least one client a desired make, model,
and series for a vehicle;
- (b) in response to the user's desired make, model, and series for a vehicle,
downloading from the at least one server to the at least one client limited configuration
21 information and limited configuration programs;

1 (c) interactively eliciting from the user on the at least one client a desired vehicle configuration and preliminarily checking at the at least one client the viability of the desired vehicle configuration using the limited configuration information and the limited configuration programs;

(d) uploading the desired vehicle configuration from the at least one client to the at
6 least one server and performing a full check on the viability of the desired vehicle configuration using full configuration information and full configuration programs on the at least one server; and

(e) responsive to the full check, preparing and outputting on the at least one client an electronic order report.

25. A method for developing a product configuration in a client-server environment, wherein
11 the server has full option attributes and full option rules, the method comprising:

(a) receiving initial product configuration data from a user on a client;

(b) in response to the initial product configuration data, allocating limited option attributes and limited option rules to the client by downloading such limited option attributes and limited option rules to the client;

16 (c) receiving from the client a first proposed product configuration developed from client processing of the limited option attributes and limited option rules;

(d) in response to the proposed product configuration and application at the server of the full option attributes and full option rules to the proposed product configuration, allocating and downloading to the client additional option rules; and

21 (e) receiving from the client a second proposed product configuration developed from client processing of the limited option attributes and additional option rules.

- 1 26. The method of claim 25 wherein act (b) further comprises allocating an HTML page and client-side programs to the client by downloading such an HTML page and client-side programs to the client.
27. The method of claim 25 wherein the act of receiving initial product configuration data from a user on a client includes enabling the user to specify whether an exact match or a loose
6 match is desired between the desired technical configuration and a viable configuration.
28. The method of claim 25 wherein the act of receiving initial product configuration data from a user on a client includes enabling the user to select templates of pre-configured product configurations.
29. In a computer network having at least one server connectable to at least one client, an
11 apparatus for creating technical configurations and electronically delivering order reports to at least one client, the apparatus comprising:
- (a) a limited configuration engine, wherein the limited configuration engine is downloaded from the at least one server to the at least one client in response to data elicited from the at least one client, and wherein the limited configuration engine contains programs to
16 interactively elicit from a user a desired configuration to be uploaded to the at least one server; and
- (b) a full configuration engine on the at least one server, wherein the full configuration engine contains instructions for performing a full check on the viability of the desired configuration.
- 21 30. The apparatus of claim 29 wherein the limited configuration engine comprises limited configuration information and limited configuration programs.

- 1 31. The apparatus of claim 29 wherein the limited configuration engine comprises limited option attributes and limited option rules.
32. The apparatus of claim 29 wherein the limited configuration engine contains programs for performing a limited check on the viability of the desired configuration.
33. The apparatus of claim 29 wherein the full configuration engine comprises full
6 configuration information and full configuration programs.
34. The apparatus of claim 29 wherein acts of uploading and downloading are carried out over the Web.
35. The apparatus of claim 29 wherein the full configuration engine is a CGI script.
36. The apparatus of claim 29 wherein the limited configuration engine comprises an HTML
11 page and client-side programs.
37. The apparatus of claim 36 wherein the client-side programs comprise a plug-in or helper-application.
38. The apparatus of claim 36 wherein the client-side programs include one or more programs selected from Java, JavaScript, ActiveX, and Helper-Viewer programs.
- 16 39. A computer-readable medium whose contents cause a computer system to perform a procedure for developing a product configuration in a client-server environment, the computer-readable medium having client programs and server programs with functions for invocation, by performing the acts of:
 - (a) interactively eliciting from a user on the client a desired subset of possible
21 products having technical configurations;

- 1 (b) in response to the user's desired subset of possible products having technical configurations, downloading from the server to the client limited configuration information and limited configuration programs;
- (c) interactively eliciting from the user on the client a desired technical configuration and preliminarily checking at the client the viability of the desired technical configuration using the
- 6 limited configuration information and the limited configuration programs;
- (d) uploading the desired technical configuration from the client to the server and performing a full check on the viability of the desired technical configuration using full configuration information and full configuration programs on the server; and
- (e) responsive to the full check, preparing and outputting on the client an electronic
- 11 order report.
40. The computer-readable medium of claim 39, wherein the computer-readable medium further comprises programs with functions for invocation by performing the acts of:
- (f) in response to the act of performing a full check on the viability of the desired technical configuration on the server, allocating and downloading to the client additional limited
- 16 configuration information; and
- (g) receiving from the client a second desired technical configuration developed from client processing of the additional limited configuration information.

Fig. 1

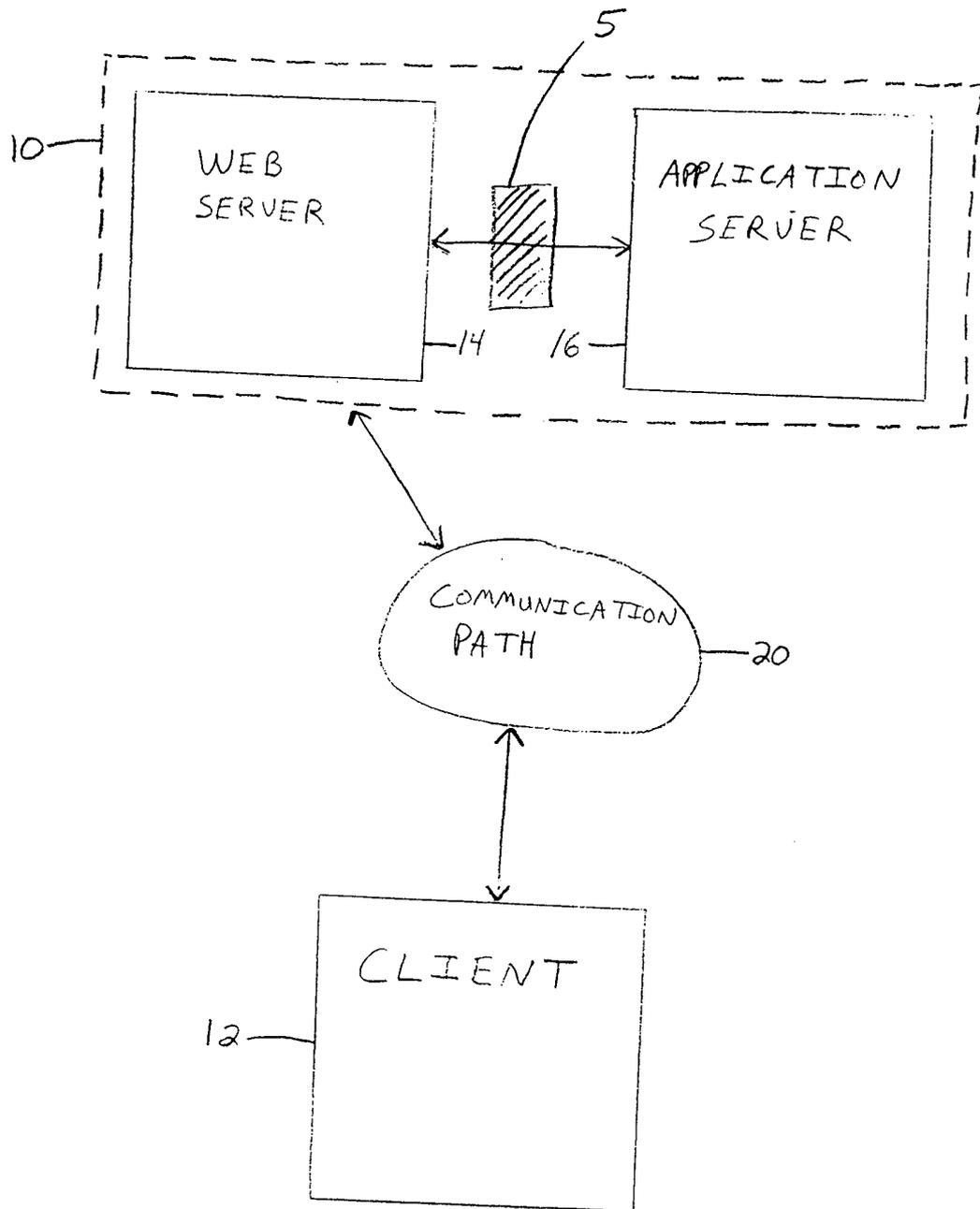

Fig. 2

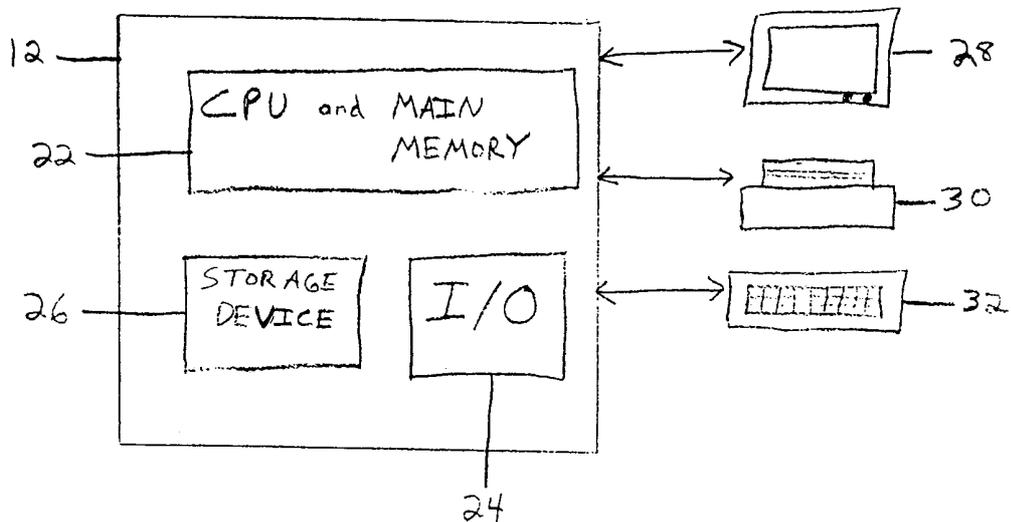

Fig. 3

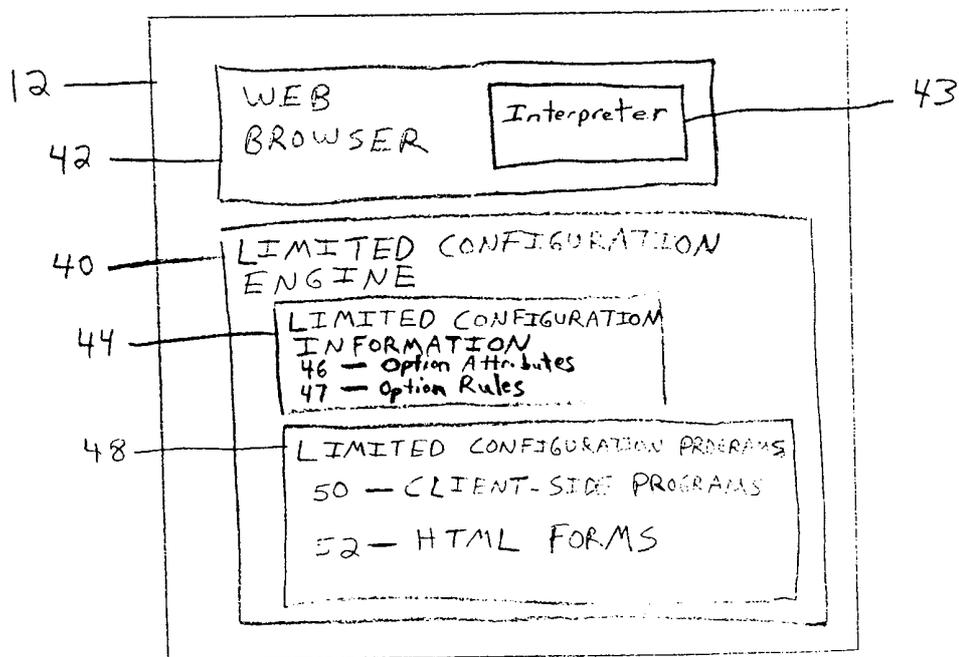

FIG. 4

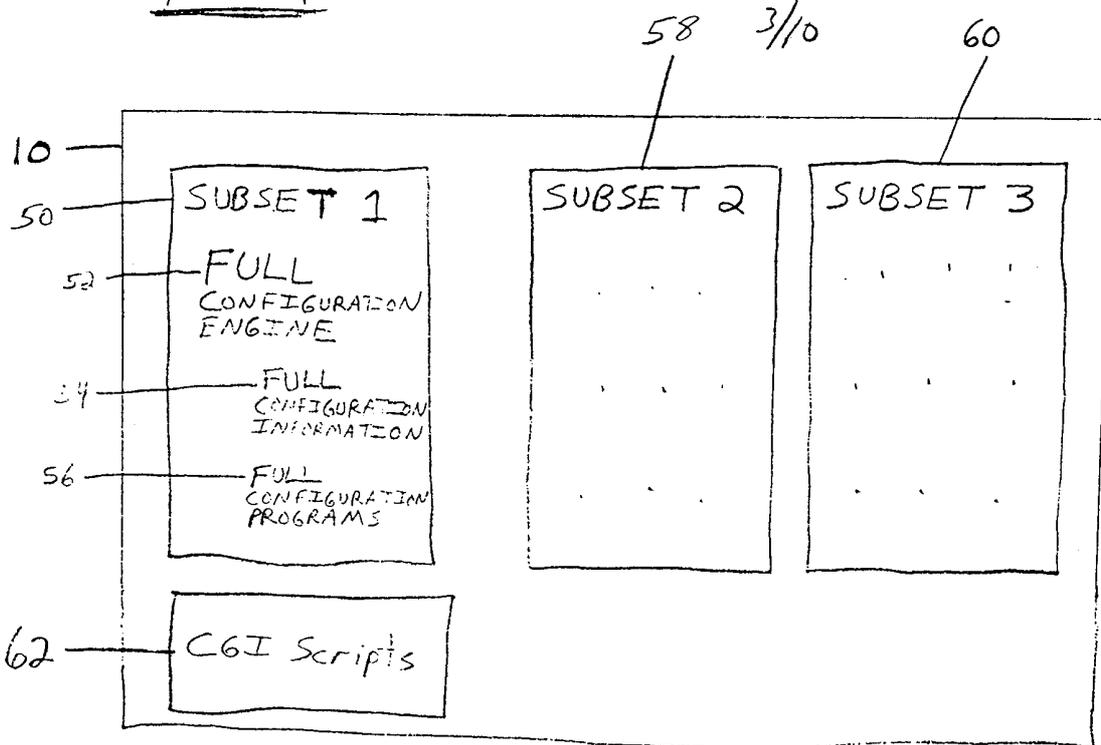

FIG. 5

- 52 — FULL CONFIGURATION ENGINE
- 64 — FULL CONFIGURATION INFO.
- 65 — FULL OPTION ATTRIBUTES
- 66 — FULL OPTION RULES
- 56 — FULL CONFIGURATION PROGRAMS
- 50 — CLIENT-SIDE PROGRAMS
- 52 — HTML FORMS
- 70 — SERVER-SIDE PROGRAMS

FIG. 6a

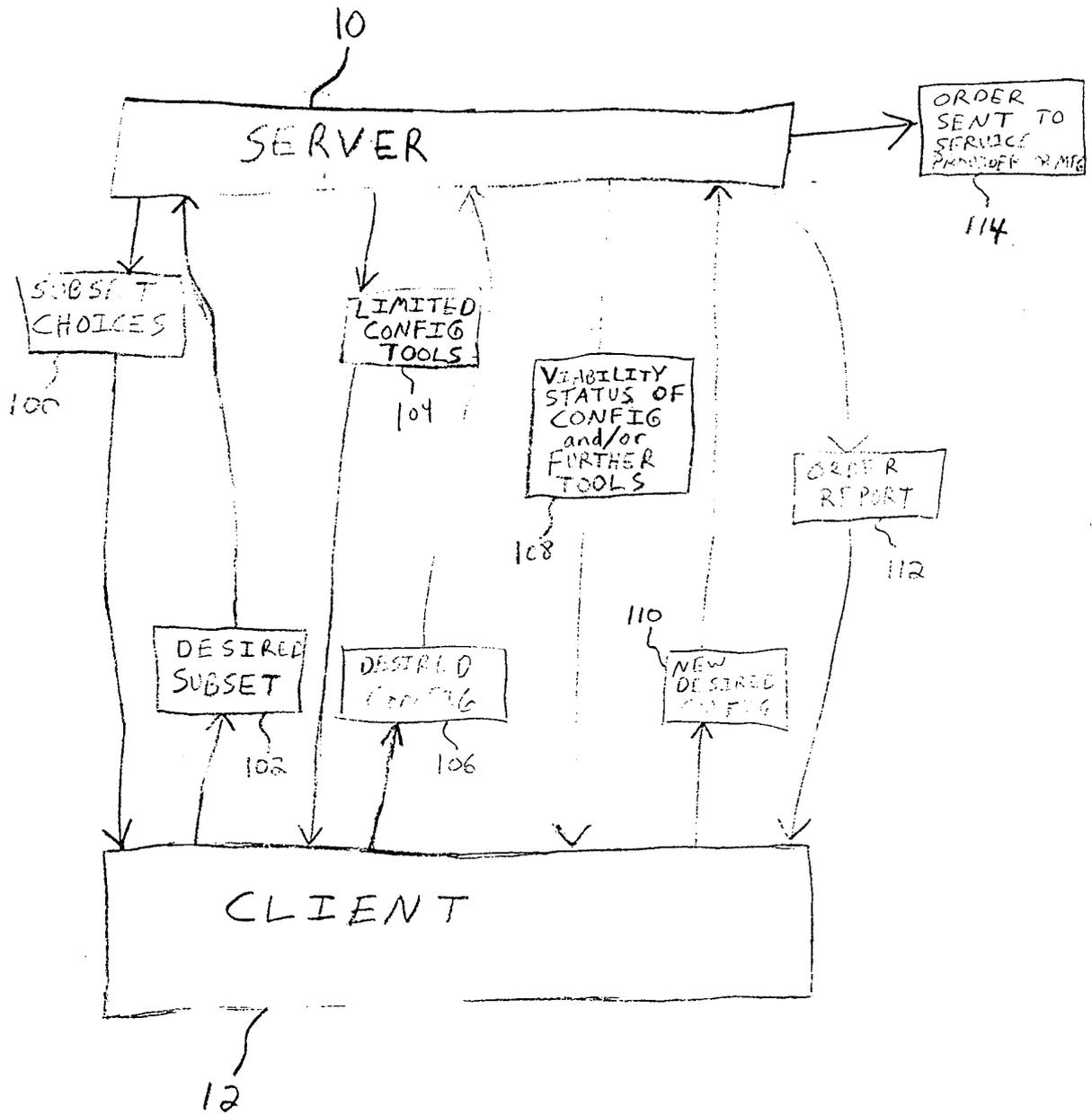

Fig. 6b

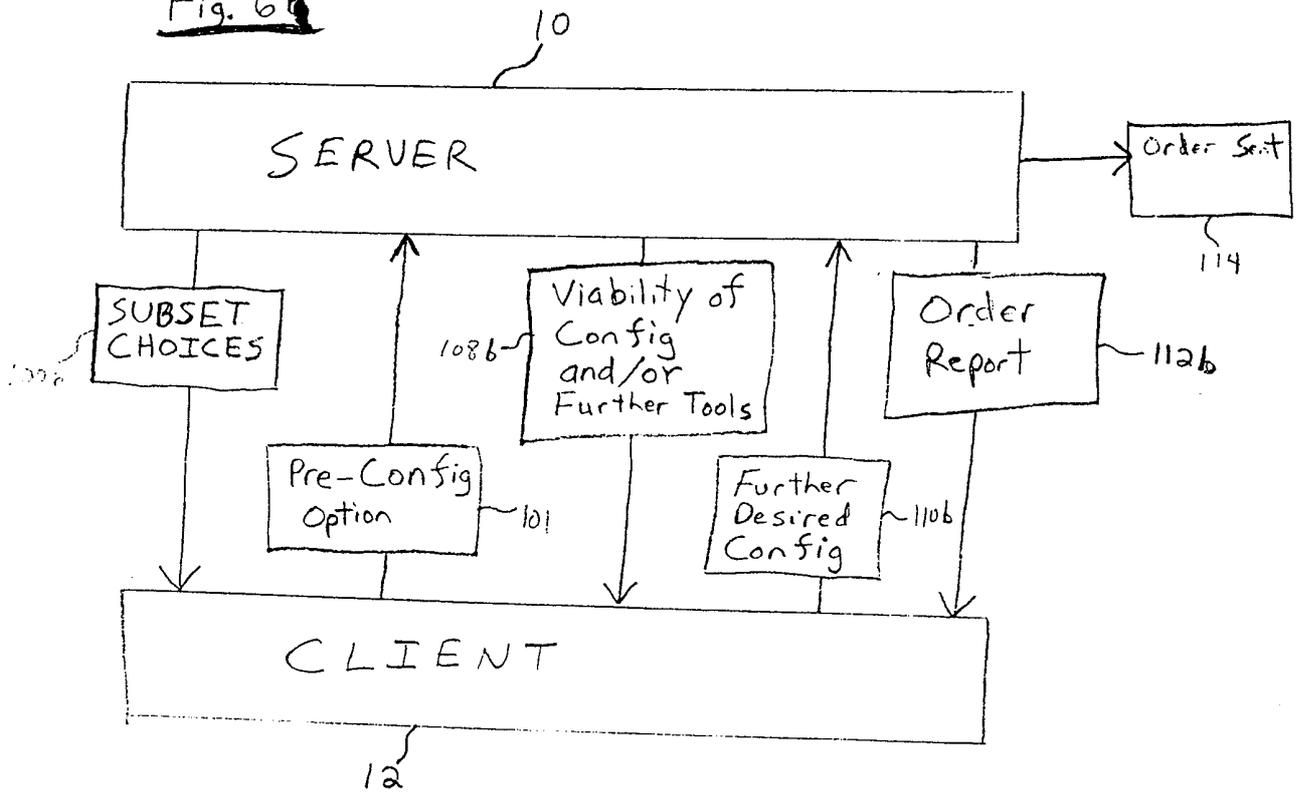

Fig. 6c

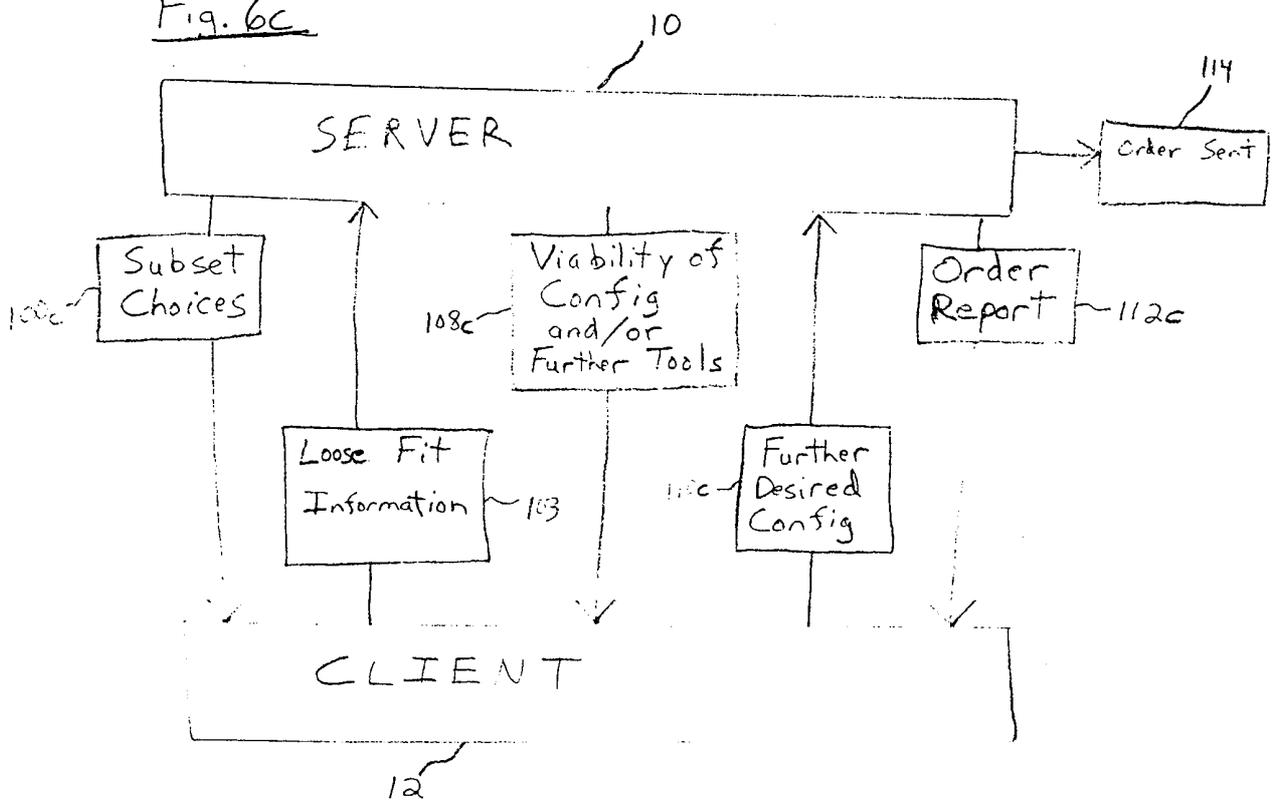

Fig 7

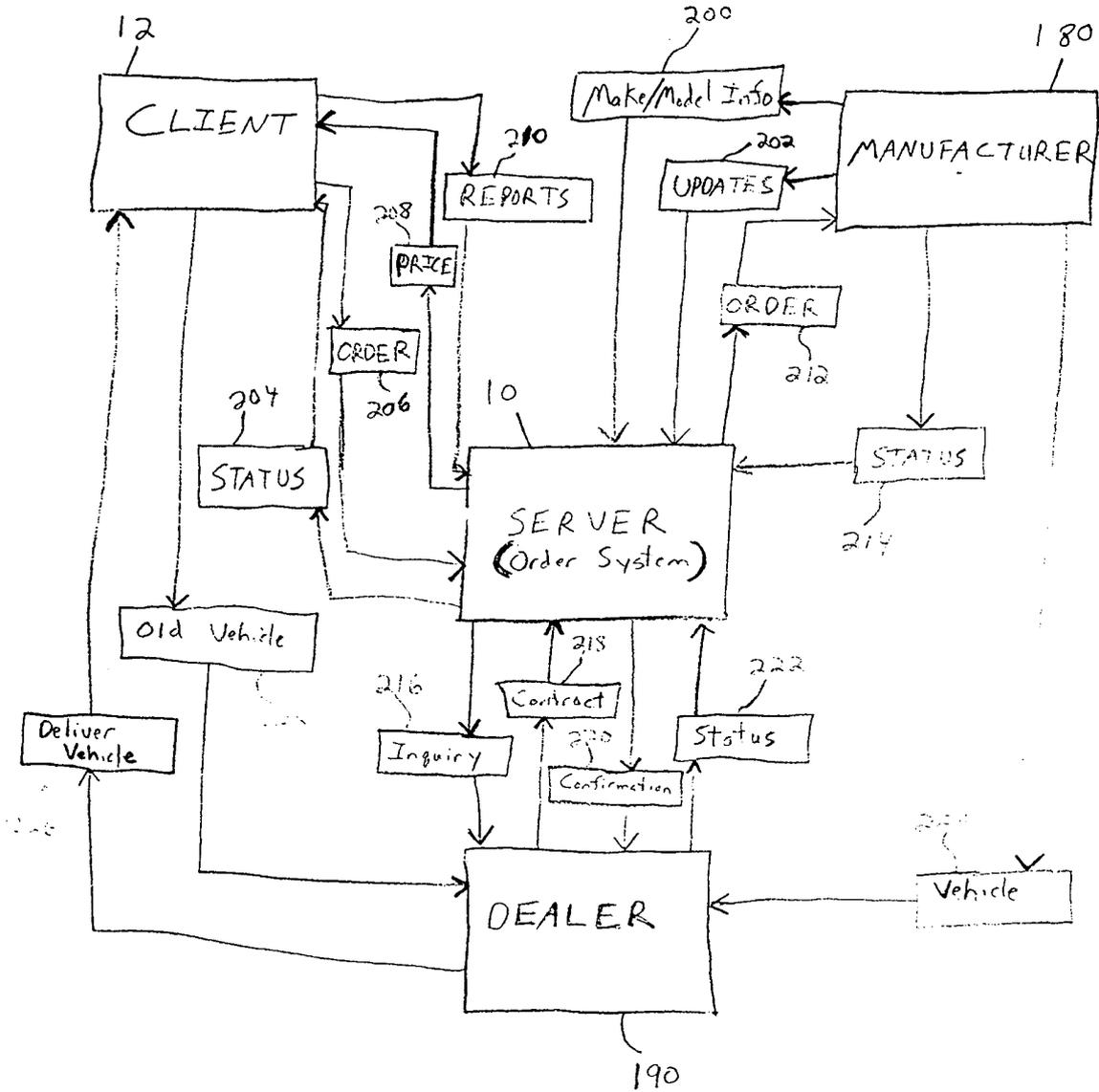

Fig. 8

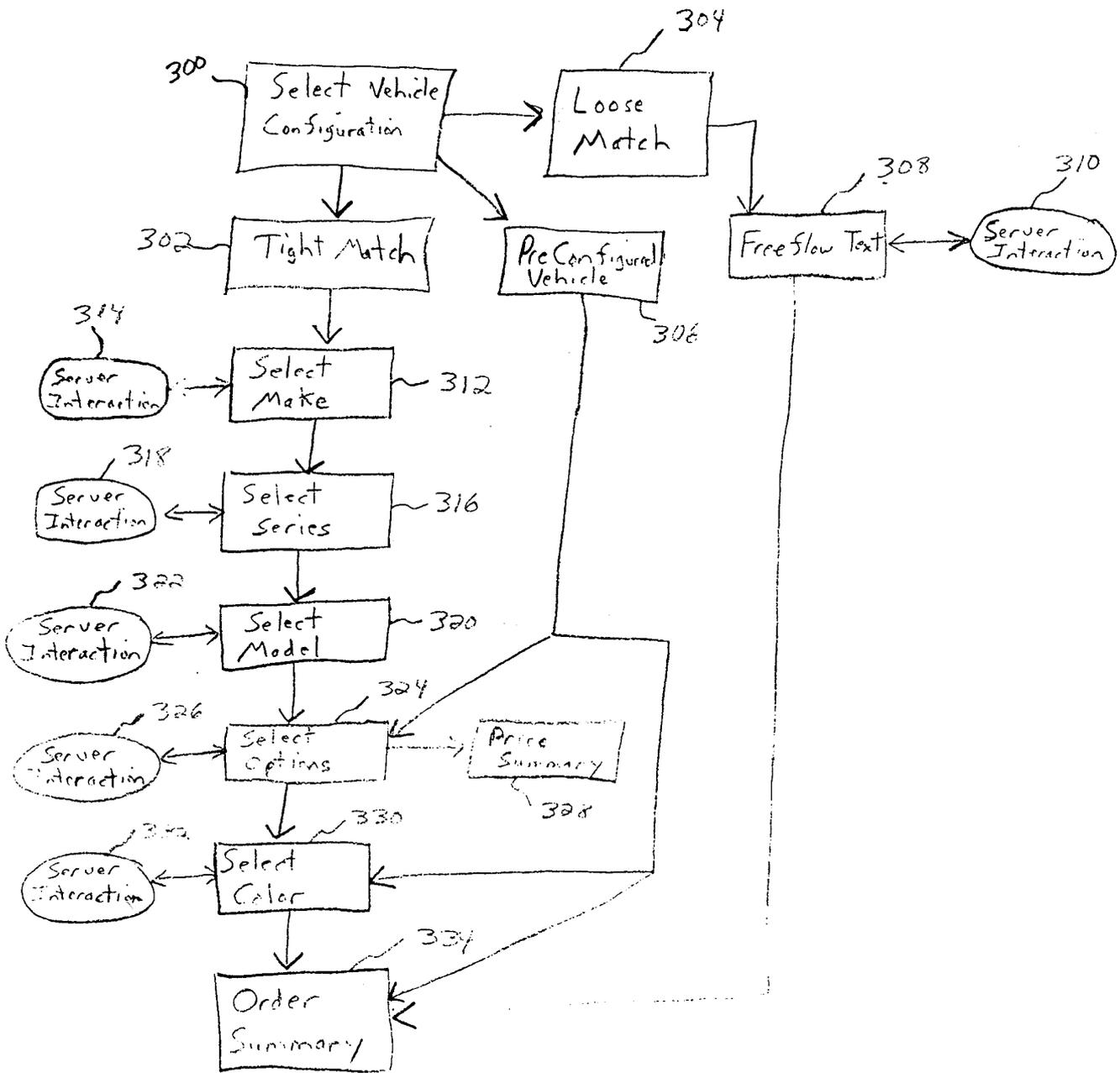

Fig. 9

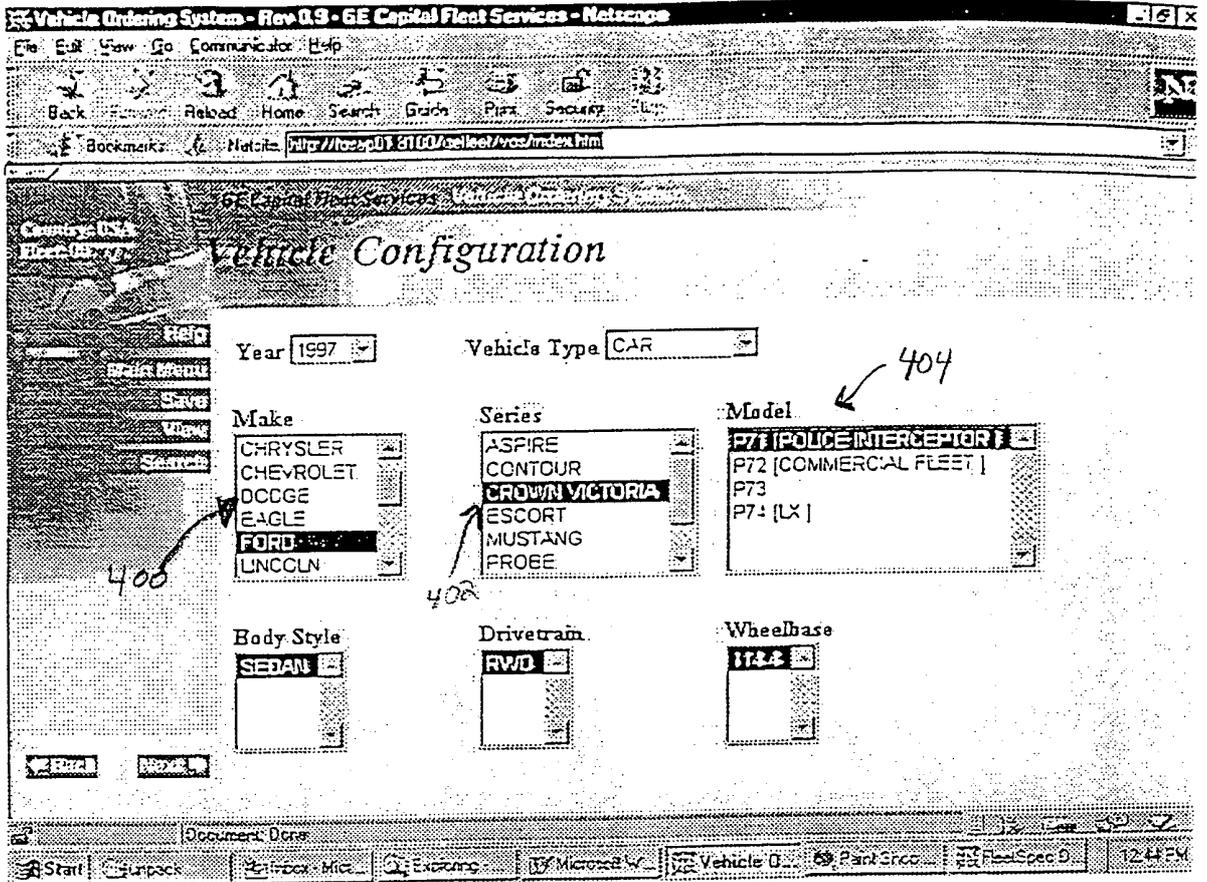

Fig. 10

Country: USA
Fleet: 007777

GE Capital Fleet Services Vehicle Ordering System

Config - Percent Complete: 75%

Vehicle Options

1999 Chevrolet CK20953 C/K 2500 Ext Cab Fleetside 8' Box Pickup

- [Help](#)
- [Main Menu](#)
- 500 →
- [Std. Equipment](#)
- [Vehicle Details](#)
- Invoice MSRP
- View Package Details
- [Price](#)
- [Previous](#) [Next](#)

Body Styles

E63 Body Code: 8' Fleetside N/C

Engines Req'd

- L31 Engine: Vortec 5700 V8 (350 Cu In) SFI N/C
- L29 Engine: Vortec 7400 V8 (454 Cu In) SFI \$510
- L65 Engine: 6.5 Liter V8 Turbo (400 Cu In) Diesel \$2431

Transmission Req'd

- MW3 Transmission: 5-Speed Manual Deep Low W/Overdrive N/C
- MT1 Transmission: 4-Speed Elec Auto W/Overdrive, HD \$846

Alternative Fuels

KL5 Alternative Fuel (Lpg And Cng Conversion Ready) \$107

Axles Req'd

- GT4 Axle: Rear, 3.73 Ratio N/C
- GT5 Axle: Rear, 4.10 Ratio N/C
- G80 Axle: Rear Locking Differential \$215

Gross Vehicle Weight

C6P Gvw: 08600 # N/C

Manufacturer Option Packages Req'd

- 1SA Package: Base Decor N/C
- 1SB Package: LS Decor \$1944
- 1SC Package: LS Premium Decor \$3248

Wheels

P06 Wheel Trim: Rally \$0

Option Packages

- V10 Cold-Climate Package \$27
- NZZ Skid Plate Package \$81
- VYU Snow Plow Prep Package \$101
- V22 Appearance Package \$0
- Z82 Trailering Special Equipment: Heavy Duty \$140
- ZQ3 Convenience Group: Tilt Steering & Speed Control \$0
- R9B Marketing Package: Bright Appearance \$385

Country: USA
Fleet: 007777

GE Capital Fleet Services Vehicle Ordering System

Configuration Summary

Config - Percent Complete: 100%

1999 Chevrolet CC20953 C/K 2500 Ext Cab Fleetside 8' Box Pickup

- [Help](#)

- [Main Menu](#)

- [Save](#)

- Remove Prices
- Remove Standard Equipment

Convert to Order

Estimated Vehicle Cost

602

ABC COMPANY
USA / 007777
Configuration #: --- Rev. ---
Last Modified: 01/08/1999
Spec #: ---

1999 CHEVROLET C/K 2500 EXT CAB
Manufacturer Model Code: CC20953
4X2 2 Door Pickup
WB: 155.5 CIA: 56.0 GVW:
8600

Garaging Address:
None specified

Vehicle Price Data - Invoice Pricing	
Base Price:	\$17924.00
Destination	\$640.00
Optional Equipment	\$-370.00
Package Discount:	\$0.00
Deleted Equipment	\$0.00
Incentive	\$-300.00

- [Previous](#)
- [Next](#)

Total Estimated Invoice Price: \$17894.00

Optional Equipment - Optional equipment is in addition to or replaces the Standard Equipment

600

604

<u>Code</u>	<u>Description</u>	<u>Invoice Price</u>
E63	Body Code: 8' Fleetside	\$0.00
L31	Engine: Vortec 5700 V8 (350 Cu In) SFI	\$0.00
MW3	Transmission: 5-Speed Manual Deep Low W/Overdrive	\$0.00
GT4	Axle: Rear, 3.73 Ratio	\$0.00
C6P	Gvw: 08600 #	\$0.00
1SA	Package: Base Decor	\$0.00
XHH	Tire: Front, LT245/75R16E All Season SBR BW	\$0.00
YHH	Tire: Rear, LT245/75R16E All Season SBR BW	\$0.00
ZY1	Paint: Exterior, Solid	\$0.00
41U	Primary - Onyx Black	\$0.00
	Paint: Exterior Solid	\$0.00
79C	Seat/Colors - Red	\$0.00
	Seat: Cloth	\$0.00
YG4	Seat Delete: Rear	\$-369.00
VX5	Fleet Incentive	\$-300.00
FE9	Emission System: Federal Emission Requirements	\$0.00

Fig. 11

INTERNATIONAL SEARCH REPORT

International application No.
PCT/US00/08292

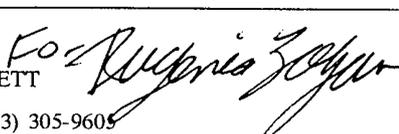
A. CLASSIFICATION OF SUBJECT MATTER IPC(7) : G06F 15/16, G06F/15/76 US CL : 709/220, 340/825 According to International Patent Classification (IPC) or to both national classification and IPC		
B. FIELDS SEARCHED Minimum documentation searched (classification system followed by classification symbols) U.S. : 709/220, 340/825, 395/712, 710/104, 713/1, 713/100 Documentation searched other than minimum documentation to the extent that such documents are included in the fields searched Electronic data base consulted during the international search (name of data base and, where practicable, search terms used) STN-uspatfull with internet, www, html, tcp, product, configuration, option, price, vehicle and automobile.		
C. DOCUMENTS CONSIDERED TO BE RELEVANT		
Category*	Citation of document, with indication, where appropriate, of the relevant passages	Relevant to claim No.
Y,E	US 6,064,982 A (PURI) 16 MAY 2000, COL. 3, LINES 1, 13, 30-31, 55-56, CO. 5, LINES 5-6, 51-53, 63-64 AND COL. 6, LINES 20-22	1-40
Y,P	US 5,926,817 A (CHRISTESON ET AL.) 20 JULY 1999 COL. 4, LINES 19-20, COL. 6, LINES 35-37	1-40
A,E	US 6,049,822 A (MITTAL) 11 APRIL 2000, col. 3, lines 8-9	1
A,P	US 6,026,431 A (HINRICHS ET AL.) 15 FEBRUARY 2000, col. 2, lines 46-48	1
A,P	⁷¹⁵ 5,966,697 A (FERGERSON ET AL.) 12 OCTOBER 1999, col. 4, lines 9-10	1
<input type="checkbox"/> Further documents are listed in the continuation of Box C. <input type="checkbox"/> See patent family annex.		
* Special categories of cited documents:	"T" later document published after the international filing date or priority date and not in conflict with the application but cited to understand the principle or theory underlying the invention	
"A" document defining the general state of the art which is not considered to be of particular relevance	"X" document of particular relevance; the claimed invention cannot be considered novel or cannot be considered to involve an inventive step when the document is taken alone	
"E" earlier document published on or after the international filing date	"Y" document of particular relevance; the claimed invention cannot be considered to involve an inventive step when the document is combined with one or more other such documents, such combination being obvious to a person skilled in the art	
"L" document which may throw doubts on priority claim(s) or which is cited to establish the publication date of another citation or other special reason (as specified)	"&" document member of the same patent family	
"O" document referring to an oral disclosure, use, exhibition or other means		
"P" document published prior to the international filing date but later than the priority date claimed		
Date of the actual completion of the international search 30 MAY 2000	Date of mailing of the international search report 06 JUL 2000	
Name and mailing address of the ISA/US Commissioner of Patents and Trademarks Box PCT Washington, D.C. 20231 Facsimile No. (703) 305-3230	Authorized officer STEPHAN WILLET  Telephone No. (703) 305-9605	