



(12) **EUROPEAN PATENT APPLICATION**

(43) Date of publication:
21.04.2021 Bulletin 2021/16

(51) Int Cl.:
A61G 13/08 (2006.01)

(21) Application number: **19203771.1**

(22) Date of filing: **17.10.2019**

(84) Designated Contracting States:
AL AT BE BG CH CY CZ DE DK EE ES FI FR GB GR HR HU IE IS IT LI LT LU LV MC MK MT NL NO PL PT RO RS SE SI SK SM TR
 Designated Extension States:
BA ME
 Designated Validation States:
KH MA MD TN

- **KÖHLER, Matthias**
Batesville, IN 47006 (US)
- **ZEH, Leonard**
Batesville, IN 47006 (US)
- **NEUENDORF, Nick**
Batesville, IN 47006 (US)
- **MÜLLER, Bertram**
Batesville, IN 47006 (US)

(71) Applicant: **TRUMPF Medizin Systeme GmbH + Co. KG**
07318 Saalfeld (DE)

(74) Representative: **Prüfer & Partner mbB**
Patentanwälte · Rechtsanwälte
Sohnckestraße 12
81479 München (DE)

(72) Inventors:
 • **JÄGER, Matthias**
Batesville, IN 47006 (US)

(54) **REMOTE CONTROL FOR A MEDICAL APPARATUS, SYSTEM OF THE REMOTE CONTROL AND THE MEDICAL APPARATUS, AND METHOD FOR OPERATING THE MEDICAL APPARATUS**

(57) A remote control (2) for controlling a medical apparatus (3) having at least one driven movable components (4, 4', 4'', 4''', 4''') is provided. The remote control (2) comprises a sensor (5) configured to detect a position and a motion of the remote control (2), and at least one release switch (6). The remote control (2) is configured to emit a control signal capable of controlling a motion of the at least one driven movable component (4, 4', 4'', 4''', 4''') according to a motion of the remote control (2) detected by the sensor (5) when a control of the motion of the at least one driven movable component (4, 4', 4'', 4''', 4''') is released by actuating the at least one release switch (6).

Fig. 1

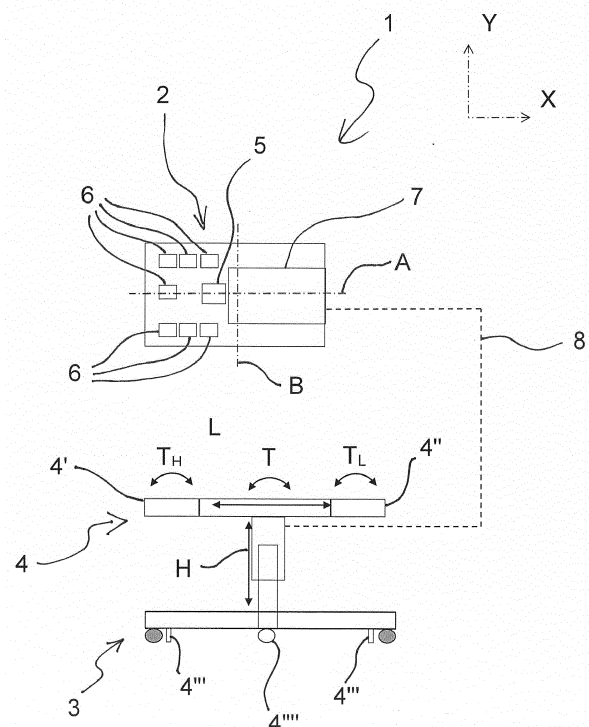

Description

[0001] The invention relates to a remote control for a medical apparatus, a system of the remote control and the medical apparatus, and a method for operating the medical apparatus, in particular, to a remote control for a medical apparatus having several movable segments driven in a controlled manner, a system of the remote control and the medical apparatus, and a method for operating the medical apparatus.

[0002] A remote control for a medical apparatus which controls motions of movable segments of the medical apparatus is known. For security against unintended use, the remote control usually includes at least one release switch and several switches for controlling motions in different directions of the respective movable segments. EP 2 455 959 A1 discloses such a remote control. However, in particular, in case of an operating table as the medical apparatus, the number of movable components, i.e., the movable segments or other movable components of the operating table, increases. Therefore, the number of the switches actuated by buttons or soft keys of a touch screen increased and the existing remote controls had the disadvantage that, due to the increased number of buttons or soft keys, an operation of the operating table became uncomfortable. Furthermore, an intuitive operation, in particular, an adjustment of a speed of the motion of the movable components was not provided.

[0003] The invention is based on the object to overcome the above disadvantages and to provide a remote control for a medical apparatus enabling a comfortable operation of the medical apparatus in an intuitive manner.

[0004] The object is achieved by a remote control according to claim 1, a system according to claim 9, and a method according to claim 16. Further developments of the invention are included in the dependent claims.

[0005] According to an aspect of the invention, a remote control for controlling a medical apparatus having at least one driven movable component comprises a sensor configured to detect a position and a motion of the remote control, and at least one release switch. The remote control is configured to emit a control signal capable of controlling a motion of the at least one driven movable component according to a motion of the remote control detected by the sensor when a control of the motion of the at least one driven movable component is released by actuating the at least one release switch.

[0006] By such a remote control, merely pressing of one button or one soft key for actuating the release switch is necessary for emitting a specific control signal since, after the release by the release switch, the control signal is then emitted due to the motion of the remote control itself.

[0007] In an advantageous implementation of the remote control, the remote control is configured to emit the control signal according to a direction of the motion of the remote control detected by the sensor with respect

to a position of the remote control when the at least one release switch is actuated to start the release of the control of the motion of the at least one driven movable component.

5 **[0008]** When the control signal is emitted according to the direction of the motion of the remote control, an intuitive operation or motion of the movable component is simply possible by moving the remote control according to a desired motion of the movable component.

10 **[0009]** In a further advantageous implementation of the remote control, the remote control is configured to emit the control signal according to an amount of the motion of the remote control.

15 **[0010]** By emitting the control signal according to the amount of the motion of the remote control, a more precise command including characteristics of the motion of the remote control can be emitted for controlling the medical apparatus easily in an intuitive manner.

20 **[0011]** In a further advantageous implementation of the remote control, the remote control is configured to emit the control signal according to a speed of the motion of the remote control.

25 **[0012]** By emitting the control signal according to the speed of the motion of the remote control, also, a more precise command including characteristics of the motion can be emitted for comfortably controlling the medical apparatus in an intuitive manner.

30 **[0013]** According to a further advantageous implementation of the remote control, the remote control comprises a display configured to detect a location of a contact of an object.

35 **[0014]** Such a touch display or touchscreen enables an easy change of soft keys provided for different medical apparatuses or different configurations of one kind of medical apparatuses. Moreover, different languages or pictograms for denoting the soft keys are possible for an easy operation of the remote control.

40 **[0015]** In a further advantageous implementation of the remote control, the remote control comprises a display configured to display a preview of the motion of the at least one driven movable component according to the control signal.

[0016] By this display, an operator can easily verify the intended motion of the medical apparatus.

45 **[0017]** According to a further advantageous implementation of the remote control, the remote control has an elongated shape and a first axis parallel to the elongated shape of the remote control and a second axis perpendicular to the elongated shape of the remote control, and the remote control is configured to emit the control signal according to a direction of the motion of the remote control around at least one of the first axis and the second axis.

50 **[0018]** In this implementation, easy and unambiguous motions of the remote control are used for determining the motion of the movable component of the medical apparatus so that the intuitive operation of the medical apparatus is easily possible and the remote control can be

operated easier.

[0019] In a further advantageous implementation of the remote control, the remote control is configured to emit the control signal according to the direction of the motion of the remote control around at least one of the first axis and the second axis if the motion of the remote control around the at least one of the first axis and the second axis exceeds a predefined threshold.

[0020] By the emission of the control signal not before exceeding a predefined threshold of the motion of the remote control around the at least one of the first axis and the second axis, the remote control can be operated more easily since a motion of the remote control is not required in a very exact manner and an unintended operation around one of the first and second axis is quite safe prevented.

[0021] According to a further aspect of the invention, a system of the remote control and the medical apparatus is provided. The remote control is configured to control the motion of the at least one driven movable component of the medical apparatus by the control signal.

[0022] By the provision of this system, the medical apparatus can be comfortably operated without a need for searching an appropriate button or soft key for operating a specific motion of the movable component of the medical apparatus.

[0023] In an advantageous implementation of the system, the remote control is configured to control a direction of the motion of the at least one driven movable component according to a direction of the motion of the remote control with respect to a position of the remote control when the at least one release switch starts to release the control of the motion.

[0024] By this characteristic, the motion of the movable component can be initiated intuitively so that the operation of the medical apparatus is facilitated.

[0025] In an advantageous implementation of the system, the remote control comprises several release switches, the medical apparatus comprises several driven movable components respectively driven by a driving device, and the several release switches are respectively assigned to a specific motion of one of the driven movable components.

[0026] In such a system, several movable components of the medical apparatus can be controlled in an easy and intuitive manner. On the one hand, if one movable component performs several motions, for example, by one release switch, a height adjustment of a tabletop of an operating table can be released and, by another release switch, tilting of the tabletop around its longitudinal axis can be released, therefore, the several release switches release the control of the motions of one movable component. On the other hand, if merely one motion is executed by one of the driven movable component, the control of this motion is released, so that the several release switches release the motions of several driven movable components.

[0027] In a further advantageous implementation of the

system, the medical apparatus comprises at least one driven movable component which performs several motions respectively driven by a driving device, and the system is configured such that the several motions are controlled by the remote control when the several motions of the at least one driven movable component are released by a release button assigned to the at least one driven movable component, wherein the several motions are controlled according to motions of the remote control around a first axis parallel to an elongated shape of the remote control and a second axis perpendicular to the elongated shape of the remote control.

[0028] In this implementation, easy and unambiguous motions of the remote control are used for determining the motion of the movable component of the medical apparatus so that the intuitive operation of the medical apparatus is easily possible and the remote control can be operated more easily since no further release switches for releasing the several motions of the at least one driven movable component are necessary.

[0029] In an advantageous implementation of the system, the medical apparatus is configured as an operating table.

[0030] In particular, an operating table can comprise a large quantity of driven movable segments for adjusting the position of a patient in a surgical treatment and of other driven movable components. Moreover, there is a necessity for adjusting the movable segments during surgery. Therefore, the easy and intuitive operation of the operating table is a tremendous advantage.

[0031] In a further advantageous implementation of the system, one of the at least one driven components is formed by a locking device configured to lock a motion of the operating table by touching a face supporting the operating table.

[0032] By providing this component and by operating this component by means of the remote control, a position of the operating table before a surgical intervention can be easily secured and after the surgical intervention, the operating table the secured position can be easily released in an intuitive manner.

[0033] In a yet further advantageous implementation of the system, one of the at least one driven components is formed by a wheel of the operating table, wherein the wheel comprises a drive and the wheel is configured to move the operating table by the drive.

[0034] By the provision of the driven wheel controlled by the remote control, the motion of the operating table together with the patient into an operating theatre and out of an operating theatre is easily possible in an easy and intuitive manner of controlling.

[0035] According to another aspect of the invention, a method for operating a medical apparatus by means of a remote control comprises the steps: releasing a control of a motion of a specific one of driven movable components of the medical apparatus by actuating a specific release switch of the remote control and controlling a motion of the specific one of the movable components

by moving the remote control with respect to a position of the remote control when the specific release switch starts to release the control of the motion of the specific one of the movable components.

[0036] By the provision of this method, the driven movable components of the medical apparatus can be operated without a need for searching an appropriate button or soft key for operating a specific motion of the movable component of the medical apparatus.

[0037] In an advantageous implementation of the method, a direction of the motion of the specific one of the driven movable components is defined by a direction of motion of the remote control around at least one of an axis parallel to an elongated shape of the remote control and an axis perpendicular to the elongated shape of the remote control.

[0038] In this implementation of the method, easy and unambiguous motions of the remote control are used for determining the motion of the movable component of the medical apparatus so that the intuitive operation of the medical apparatus is easily possible.

[0039] In a further advantageous implementation of the method, the motion of the specific one of the driven movable components is stopped when the remote control is moved into a horizontal position.

[0040] By this implementation, stopping of the motion of the movable components is easily and intuitively possible.

[0041] Below, the invention is elucidated by means of embodiments referring to the attached drawings.

[0042] In particular,

Fig. 1 shows a system of a remote control in a schematic plan view and of an operating table in a schematic side view;

Fig. 2 shows a starting position and an end position of the remote control in a schematic side view when the remote control is tilted around an axis perpendicular to an elongated shape of the remote control for controlling a motion;

Fig. 3 shows another starting position and the end position of the remote control in the schematic side view when the remote control is tilted around the axis perpendicular to the elongated shape of the remote control for controlling a motion;

Fig. 4 shows a starting position and an end position of the remote control in a schematic front view when the remote control is tilted around an axis parallel to an elongated shape of the remote control for controlling a motion;

Fig. 5 shows another starting position and the end position of the remote control in the schematic front view when the remote control is tilted around the axis parallel to the elongated shape

of the remote control for controlling a motion;

Fig. 6 shows a plan view of the remote control; and

Fig. 7 shows a flow chart of a method according to the invention.

[0043] Fig. 1 shows a system 1 according to the invention including a remote control 2 in a schematic plan view and an operating table as an embodiment of a medical apparatus 3 in a schematic side view.

[0044] The medical apparatus 3 comprises several movable components, in particular several movable segments, namely, an entire tabletop 4, and a head plate 4' and a leg plate 4" of the tabletop 4. The medical apparatus 1 further comprises a driven locking device 4''' and a driven wheel 4''''.

[0045] The movable segments 4, 4', 4" are respectively driven by at least one driving device (not shown). The tabletop 4 is moved by a first driving device (not shown) in a vertical direction depicted by arrow H for adjusting a height of the tabletop 4. Further, the tabletop 4 is tilted by a second driving device (not shown) into a Trendelenburg position or an Anti-Trendelenburg position as depicted by arrow T. Furthermore, the tabletop 4 is displaced by a third driving device (not shown) along a longitudinal axis of the tabletop 4 as depicted by arrow L. The head plate 4' is tilted by a fourth driving device (not shown) as depicted by arrow T_H and the leg plate 4" is tilted by a fifth driving device (not shown) as depicted by arrow T_L. Alternatively, the medical apparatus 3 is provided with another number of driven movable segments 4, 4', 4", wherein at least one driven segment 4, 4', 4" movable in different directions is provided.

[0046] The driven locking device 4''' comprises jack up stamps as support structures for securing a sure footing of the medical apparatus 1, i.e. for locking a motion of the entire operating table by touching a face supporting the operating table, i.e. a floor. The jack up stamps are lowered for touching the floor and, as the case may be, for lifting the operating table in order to lock the operating table. For moving the operating table, the jack up stamps are retracted and there is a gap between the jack up stamps and the face supporting the operating table. The jack up stamps are driven by a hydraulic drive. Alternatively, the jack up stamps are driven by electric drives or, further alternatively, the locking device is not provided, e.g., in case of a stationary operating table.

[0047] The driven wheel 4'''' is provided as a fifth wheel in a center of a chassis of the operating table additionally to wheels for moving the medical apparatus 1 in corners of the chassis of the operating table. The fifth wheel comprises a drive and the wheel moves the operating table by the drive when the wheel contacts the face supporting the operating table. Alternatively, also one or several of the wheels in the corners of the chassis of the operating table can be formed as the driven wheel 4'''' or, further alternatively, the driven wheel is not provided, e.g., in

case of a stationary operating table.

[0048] The remote control 2 comprises a sensor 5. The sensor 5 comprises an inclinometer. Alternatively or additionally, the sensor 5 comprises another type of sensor, e.g., an acceleration sensors or a gyroscope combined with a geomagnetic sensor. The sensor 5 detects a position and a motion or an acceleration of the remote control 2.

[0049] Furthermore, the remote control 2 comprises seven release switches 6. The release switches 6 are respectively assigned to a specific motion of one of the driven movable segments 4, 4', 4", of the locking device 4"', and of the driven wheel 4'''. By a first one of the release switches 6, the control of the vertical motion of the tabletop 4 can be released, by a second one of the release switches 6, the control of the tilting of the tabletop 4 into the Trendelenburg position or Anti-Trendelenburg position and a tilting around a longitudinal axis of the tabletop 4 can be released. A third one of the release switches 6 releases the control of the displacement of the tabletop 4 in the longitudinal direction of the tabletop 4, a fourth one of the release switches 6 releases the control of the tilting of the head plate 4', and a fifth one of the release switches 6 releases the control of the tilting of the leg plate 4". A sixth one of the release switches 6 releases the control of the locking device 4"', i.e., initiates lifting or lowering the jack up stamps, and a seventh one of the release switches releases the control of the driven wheel 4''' for driving the operating table. In a further alternative embodiment, another number of release switches 6, e.g., according to a number of motions of the movable components 4, 4', 4", 4''', 4'''' merely one release switch 6, or more than two release switches 6, are provided.

[0050] The remote control 2 has an elongated shape and it has an axis A parallel to the elongated shape in a X axis direction of the remote control 2 and an axis B perpendicular to the elongated shape in a Y axis direction of the remote control 2. Alternatively, the remote control 2 does not have an elongated shape and the axes A and B, if necessary, are determined by definition.

[0051] The remote control 2 further comprises a communication interface 7. The communication interface 7 establishes a communication 8 to the medical apparatus 3 in a wireless manner. Alternatively, the communication interface 7 has a connection cable and establishes the communication 8 to the medical apparatus 3 in a wired manner.

[0052] By the communication 8, the remote control 2 emits a control signal capable of controlling the motion of the movable components 4, 4', 4", 4''', 4'''' according to a motion of the remote control 2 detected by the sensor 5 when the control of the motion of the driven movable components 4, 4', 4", 4''', 4'''' is released by actuating the release switch 6. In particular, the remote control 2 emits the control signal according to a direction of the motion of the remote control 2 detected by the sensor 5 with respect to a position of the remote control 2 when the

release switch 6 starts to release the motion. The remote control 2 emits the control signal according to an amount of the motion of the remote control 2. Additionally, the remote control 2 emits the control signal according to a speed of the motion of the remote control 2. Alternatively, the amount and/or the speed of the motion of the remote control 2 are not considered, and, further alternatively, the direction of the motion is not considered but any motion is considered for moving the driven movable component 4, 4', 4", 4''', 4'''' e.g., in a reciprocating manner.

[0053] By emitting the control signal, the remote control 2 is configured to control the direction of the motion of the driven movable components 4, 4', 4", 4''', 4'''' according to the direction of the motion of the remote control 2 with respect to a position of the remote control 2 when the release button 6 starts to release the motion. Furthermore, the remote control 2 is configured to control a speed of the motion of the driven movable components 4, 4', 4", 4''', 4'''' according to the amount of the motion of the remote control 2 with respect to the position of the remote control 2 when the release button 6 starts to release the motion, wherein the speed of the driven movable components 4, 4', 4", 4''', 4'''' is the higher the larger the amount of the motion of the remote control 2 is. By reducing the amount of the motion of the remote control 2, the speed can be reduced. Optionally, a sensitivity of the remote control 2 can be adjusted. In case of a high sensitivity, 100% of the speed of the driven movable components 4, 4', 4", 4''', 4'''' is achieved upon tilting of the remote control 2 of 30 degrees around one of the axes A or B. When a mid sensitivity is set, 100% of the speed of the driven mobile components 4, 4', 4", 4''', 4'''' is achieved upon tilting of the remote control 2 of 35 degrees around one of the axes A or B, and, when a low sensitivity is set, 100% of the speed of the driven mobile components 4, 4', 4", 4''', 4'''' is achieved upon tilting of the remote control 2 of 45 degrees around one of the axes A or B. Alternatively, other appropriate values of the amount of tilting can be set.

[0054] Moreover, the remote control 2 is configured to control the speed of the motion of the driven movable components 4, 4', 4", 4''', 4'''' according to the speed of the motion of the remote control 2, wherein the speed of the motion of the driven movable components 4, 4', 4", 4''', 4'''' is the higher the higher the speed of the motion of the remote control 2 is. In alternative embodiments, the amount and/or the speed of the motion of the remote control 2 is not considered for the control of the speed of the driven movable components 4, 4', 4", 4''', 4''''.

[0055] According to the manner of tilting the remote control 2, the speed of the motion can be adjusted between 1 % and 100 % of a nominal speed. Alternatively, an adjusted speed is fix independently from the manner of tilting the remote control 2.

[0056] The motion of the remote control 2 detected by the sensor 5 is a tilting around the axis B of the remote control 2 perpendicular to its elongated shape and a tilting around the longitudinal axis A of the remote control 2

parallel to its elongated shape. By the detection of the motion around the axis B of the remote control 2 perpendicular to its elongated shape, the vertical motion of the tabletop 4 and the displacement motions along the axis L are controlled. By tilting the remote control 2 in one direction, the tabletop 4 is lifted and, by tilting the remote control in the other direction, the tabletop 4 is lowered. By the detection of the motion around the axis A of the remote control 2 parallel to the elongated shape, the tilting motions of the table top 4, of the head plate 4', and of the leg plate 4'' are controlled. In alternative embodiments, any of the motions are controlled either by detecting the motion around the axis A of the remote control 2, by detecting the motion around the axis B of the remote control 2, or by detecting the motion around the axis A and the axis B.

[0057] A combined motion of the remote control 2, i.e., the tilting around the axis B of the remote control 2 and the tilting around the longitudinal axis A of the remote control 2 controls several motions respectively driven by a driving device of one of the movable components 4, 4', 4'', 4'''. Upon an actuation of the release switch 6 assigned to the tabletop 4 and a tilting of the remote control 2 around the axis B, a control signal for approaching the Trendelenburg position or the Anti-Trendelenburg position is emitted and the motion is performed by the medical apparatus 1, and, simultaneously, when tilting the remote control 2 around the longitudinal axis A of the remote control 2, a control signal for tilting of the tabletop 4 according to a direction of the tilting of the remote control 2 is emitted and the motion is performed by the medical apparatus 1.

[0058] The leg section 4'' is partitioned along the longitudinal axis of the tabletop 4 and it comprises a left leg section and a right leg section. Upward or downward motion of one of the left and right leg sections is actuated upon releasing the control of the leg section 4'' by the respective release switch 6 and upon tilting the remote control 2 in a respective leftward or rightward direction and upward or downward for emitting a respective control signal by the remote control 2 and the motion is performed by the medical apparatus 1.

[0059] Fig 2 shows a starting position and an end position of the remote control 2 in a side view when the remote control 2 is tilted around the axis B in the Y axis direction (Fig. 1) of the remote control 2 perpendicular to an elongated shape of the remote control 2 for controlling one of the motions. The initial position of the remote control 2 where the release switch 6 is actuated is depicted by dashed lines and the end position of the remote control 2 is depicted by solid lines. The speed and the direction of the motion of the driven movable components 4, 4', 4'', 4''', the control of which is released by actuating the respective release switch 6, are determined by the movement of the remote control 2 around the axis B. In Fig. 2, in the initial position of the remote control 2, a Z axis of the remote control 2 is oriented vertically so the remote control 2 is oriented in a horizontal position.

[0060] Fig. 3 shows another starting position and the end position of the remote control 2 of Fig. 2 in the side view when the remote control 2 is tilted around the axis B perpendicular to the elongated shape of the remote control 2 for controlling one of the motions. The initial position of the remote control 2 where the release switch 6 is actuated is depicted by dashed lines and the end position of the remote control 2 is depicted by solid lines. This figure shows that the motion of the driven components 4, 4', 4'', 4''', 4'''' of the medical apparatus 3 is not to be controlled compulsorily starting from the horizontal position of the remote control 2 but, also, another position is possible if the release switch 6 is actuated in this position and the remote control 2 is moved in a specific manner in order to control the motion.

[0061] Fig. 4 shows the starting position and the end position of the remote control 2 in a front view when the remote control 2 is tilted around the axis A in the X axis direction (Fig. 1) of the remote control 2 parallel to an elongated shape of the remote control 2. The initial position of the remote control 2 where the release switch 6 is actuated is depicted by dashed lines and the end position of the remote control 2 is depicted by solid lines. The speed and the direction of the motion of the driven movable components 4, 4', 4'', 4''', 4'''' the control of which is released by actuating the respective release switch 6, are determined by the movement of the remote control 2 around the axis A. In Fig. 4, in the initial position of the remote control 2, the Z axis of the remote control 2 is oriented vertically so the remote control 2 is oriented in a horizontal position.

[0062] Fig. 5 shows another starting position and the end position of the remote control 2 of Fig. 4 in the front view when the remote control 2 is tilted around the axis A parallel to the elongated shape of the remote control 2 for controlling one of the motions. This figure shows that the motion of the driven components 4, 4', 4'', 4''', 4'''' of the medical apparatus 3 is not to be controlled compulsorily starting from the horizontal position of the remote control 2 but, also, another position is possible if the release switch 6 is actuated in this position and the remote control 2 is moved in a specific manner in order to control the motion.

[0063] Referring to Figs 2 to 5, the control signal according to the direction of the motion of the remote control 2 around at least one of the first axis A and the second axis B is only emitted if the motion of the remote control 2 around the at least one of the first axis A and the second axis B exceeds a predefined threshold. In this embodiment, the threshold is set to 3 degrees. In alternative embodiments, the threshold is set to other appropriate values, preferably between zero degrees and 6 degrees or no threshold is set.

[0064] Fig. 6 shows a plan view of the remote control 2. The remote control 2 comprises a display 10 configured to detect a location of a touch of an object, wherein the display 10 is commonly denoted as a touchscreen. The object usually is a finger of an operator, i.e., of an

operating room nurse.

[0065] The display 10 displays several operating states 11 of the operating table. These operating states are, e.g. a status as, e.g., a height, a longitudinal travel or a Trendelenburg angle, error messages, user information, etc.. Further, the display 10 depicts soft keys 12 having an appearance of usual press buttons. Alternatively, the soft keys 12 have another appearance. When pressing one of the soft keys 12, one of the release switches 6 (not shown in Fig. 6) is actuated.

[0066] In a further area of the display 10, an illustration of the medical apparatus 3 is depicted. The display 10 is further configured to display a preview of the motion of the at least one driven movable component 4, 4', 4'', 4''', 4'''' according to the control signal so as to depict a live preview of the motions.

[0067] Fig. 7 shows a flow chart of a method according to the invention.

[0068] In use, in a first step S1, the control of a specific one of the motions of the driven movable components 4, 4', 4'', 4''', 4'''' of the medical apparatus 3 is released by actuating a specific release switch 6 of the remote control 2 assigned to the specific motion.

[0069] In a next step S2, the motion of the specific one of the movable components 4, 4', 4'', 4''', 4'''' is controlled by moving the remote control 2 with respect to a position of the remote control 2 when the specific release switch 6 is actuated.

[0070] The direction of the motion of the specific one of the driven movable components 4, 4', 4'', 4''', 4'''' is defined by the direction of motion of the remote control 2 around the axis B perpendicular to an elongated shape of the remote control 2 and/or around the axis A parallel to the elongated shape of the remote control 2.

[0071] The remote control 2 emits a stop command for stopping the motion of the driven movable components 4, 4', 4'', 4''', 4'''' when the remote control 2 is moved into a horizontal position so that the motion of the specific one of the driven movable components 4, 4', 4'', 4''', 4'''' is stopped. This function is not compulsorily and, alternatively, the motion is stopped when the release switch 6 is not actuated anymore and the release switch 6 does not release the command anymore. The horizontal position is detected by the inclinometer or, alternatively, by the acceleration sensor. The acceleration sensor detects components of acceleration forces in the directions of three axes X, Y, Z of the remote control 2. If the component of the acceleration force in the direction of the Z axis of the remote control 2 amounts 1g, the remote control 2 is determined as being oriented in the horizontal position.

[0072] The invention has been described in conjunction with various embodiments herein. However, other variations to the disclosed embodiments can be understood and effected by those skilled in the art in practicing the claimed invention, from a study of the drawings, the disclosure and the appended claims. Such modifications may involve other features, which are already known in

the art and may be used instead of or in addition to features already described herein. In the claims, the word "comprising" does not exclude other elements or steps, and the indefinite article "a" or "an" does not exclude a plurality.

Claims

1. A remote control (2) for controlling a medical apparatus (3) having at least one driven movable component (4, 4', 4'', 4''', 4'''), the remote control (2) comprising:
 - a sensor (5) configured to detect a position and a motion of the remote control (2), and at least one release switch (6), wherein
 - the remote control (2) is configured to emit a control signal capable of controlling a motion of the at least one driven movable component (4, 4', 4'', 4''', 4''') according to a motion of the remote control (2) detected by the sensor (5) when a control of the motion of the at least one driven movable component (4, 4', 4'', 4''', 4''') is released by actuating the at least one release switch (6).
2. The remote control (2) of claim 1, wherein the remote control (2) is configured to emit the control signal according to a direction of the motion of the remote control (2) detected by the sensor (5) with respect to a position of the remote control (2) when the at least one release switch (6) is actuated to start the release of the control of the motion of the at least one driven movable component (4, 4', 4'', 4''', 4''').
3. The remote control (2) of claim 1 or 2, wherein the remote control (2) is configured to emit the control signal according to an amount of the motion of the remote control (2).
4. The remote control (2) of anyone of claims 1 to 3, wherein the remote control (2) is configured to emit the control signal according to a speed of the motion of the remote control (2).
5. The remote control (2) of anyone of the preceding claims, wherein the remote control (2) comprises a display configured to detect a location of a touch of an object.
6. The remote control (2) of anyone of the preceding claims, wherein the remote control (2) comprises a display configured to display a preview of a motion of the at least one driven movable component (4, 4', 4'', 4''', 4''')

according to the control signal.

7. The remote control (2) of anyone of the preceding claims, wherein the remote control (2) has an elongated shape, and a first axis (A) parallel to the elongated shape of the remote control (2) and a second axis (B) perpendicular to the elongated shape of the remote control (2), wherein the remote control (2) is configured to emit the control signal according to a direction of the motion of the remote control (2) around at least one of the first axis (A) and the second axis (B).
8. The remote control (2) of claim 7, wherein the remote control (2) is configured to emit the control signal according to the direction of the motion of the remote control (2) around at least one of the first axis (A) and the second axis (B) if the motion of the remote control (2) around the at least one of the first axis (A) and the second axis (B) exceeds a predefined threshold.
9. A system (1) of a remote control (2) of anyone of the preceding claims and a medical apparatus (3), wherein the remote control (2) is configured to control the motion of at least one driven movable component (4, 4', 4", 4"', 4''') of the medical apparatus (3) by the control signal.
10. The system (1) of claim 9, wherein the remote control (2) is configured to control a direction of the motion of the at least one driven movable component (4, 4', 4", 4"', 4''') according to a direction of the motion of the remote control (2) with respect to a position of the remote control (2) when the at least one release switch (6) starts to release the control of the motion.
11. The system (1) of claim 9 or 10, wherein the remote control (2) comprises several release switches (6), the medical apparatus (3) comprises several movable components (4, 4', 4", 4"', 4''') respectively driven by a driving device, and the several release switches (6) are respectively assigned to a specific motion of one of the driven movable components (4, 4', 4", 4"', 4''').
12. The system of anyone of claims 9 to 11, wherein the medical apparatus (3) comprises at least one driven movable component (4, 4', 4", 4"', 4''') which performs several motions respectively driven by a driving device, and the system is configured such that the several motions are controlled by the remote control (2) when the several motions of the at least one driven movable component (4, 4', 4", 4"', 4''') are released by a release button assigned to the at least one driven movable component (4, 4', 4", 4"', 4'''), wherein the several motions are controlled according to motions of the remote control (2) around a first axis (A) parallel to an elongated shape of the remote control (2) and a second axis (B) perpendicular to the elongated shape of the remote control (2).
13. The system (1) of anyone of claims 9 to 12, wherein the medical apparatus (3) is configured as an operating table.
14. The system (1) of claim 13, wherein one of the at least one driven components (4, 4', 4", 4"', 4''') is formed by a locking device configured to lock a motion of the operating table by touching a face supporting the operating table.
15. The system (1) of claim 13 or 14, wherein one of the at least one driven components (4, 4', 4", 4"', 4''') is formed by a wheel of the operating table, wherein the wheel comprises a drive and the wheel is configured to move the operating table by the drive.
16. A method for operating a medical apparatus (3) by means of a remote control (2) with the steps:
- releasing a control of a motion of a specific one of driven movable components (4, 4', 4", 4"', 4''') of the medical apparatus (3) by actuating a specific release switch (6) of the remote control (2), and
- controlling a motion of the specific one of the movable components (4, 4', 4", 4"', 4''') by moving the remote control (2) with respect to a position of the remote control (2) when the specific release switch starts to release the control of the motion of the specific one of the movable components (4, 4', 4", 4"', 4''').
17. The method of claim 16, wherein a direction of the motion of the specific one of the driven movable components (4, 4', 4", 4"', 4''') is defined by a direction of motion of the remote control (2) around at least one of an axis (A) parallel to an elongated shape of the remote control (2) and an axis (B) perpendicular to the elongated shape of the remote control (2).
18. The method of claim 17, wherein the motion of the specific one of the driven movable components (4, 4', 4", 4"', 4''') is stopped when the remote control (2) is moved into a horizontal position.

Fig. 1

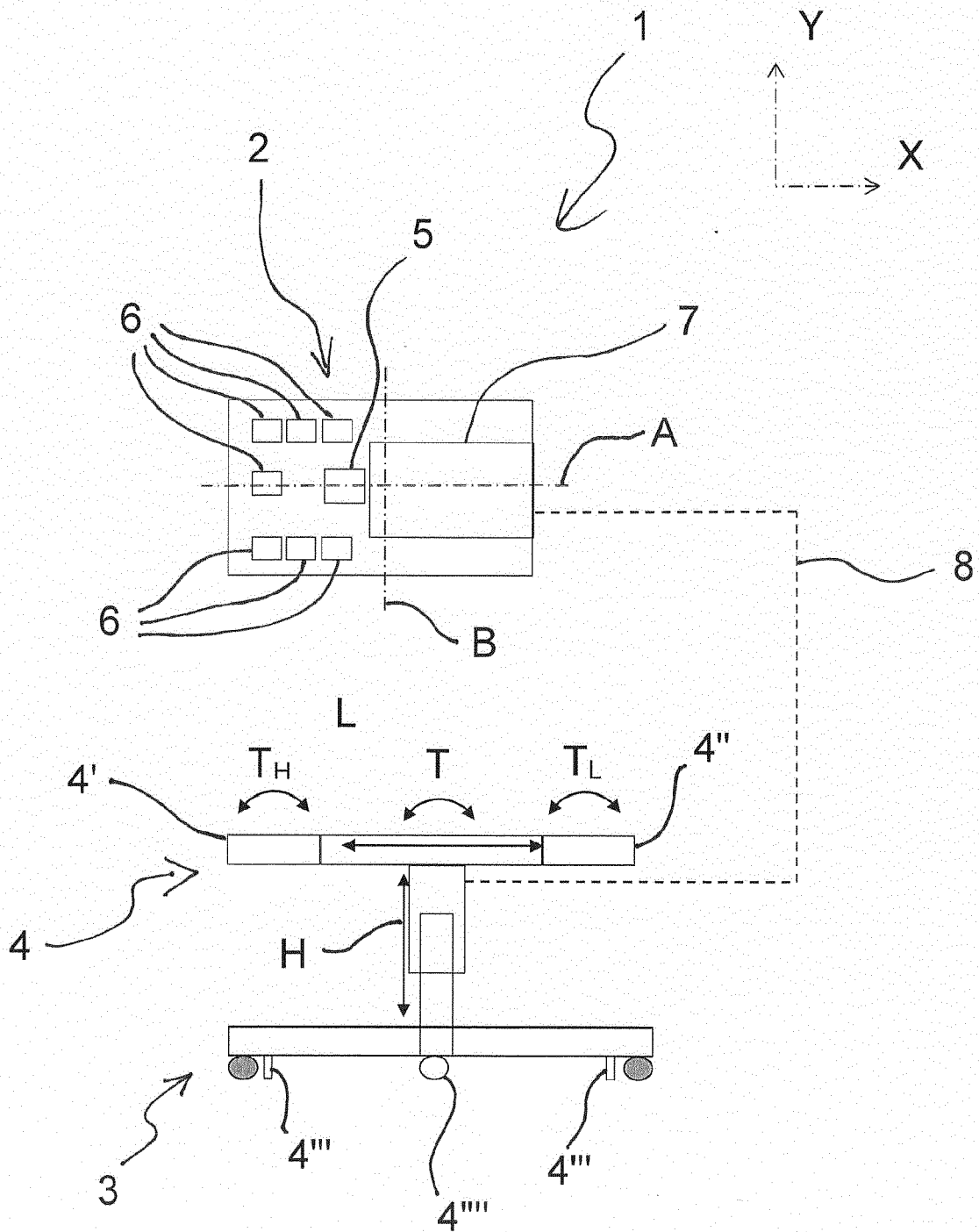

Fig. 2

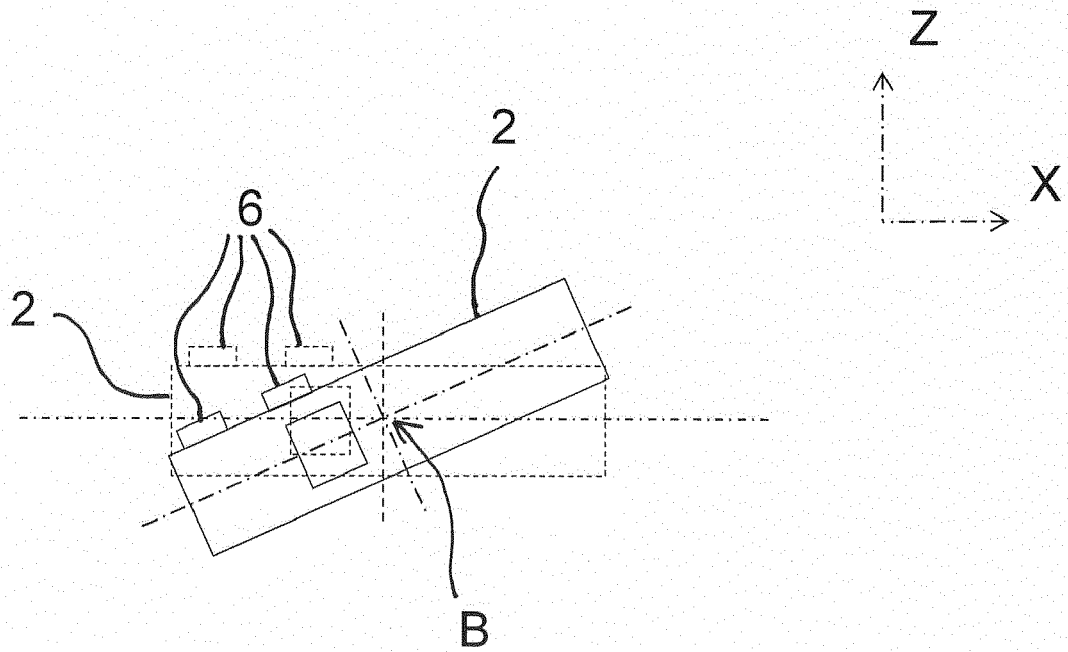

Fig. 3

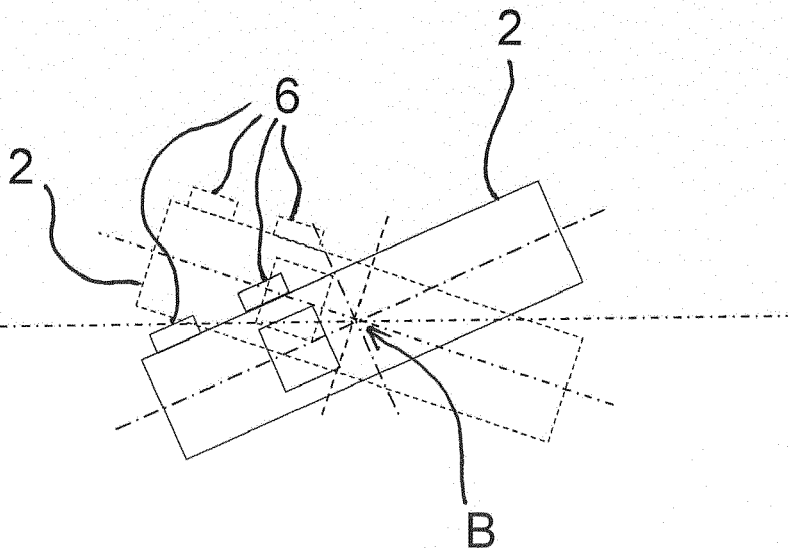

Fig. 4

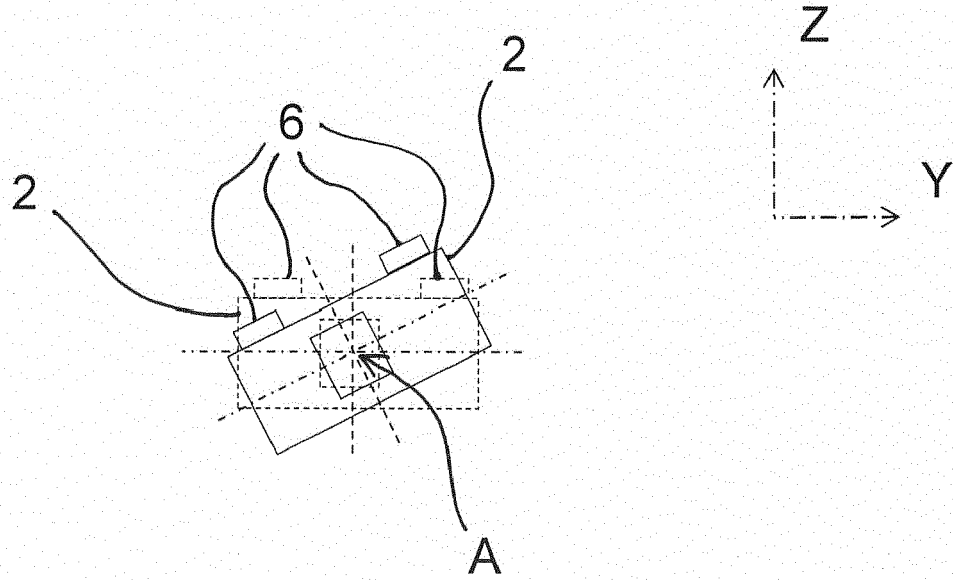

Fig. 5

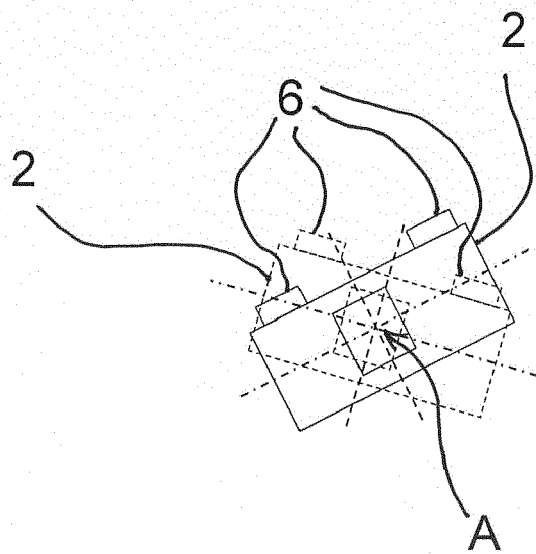

Fig. 6

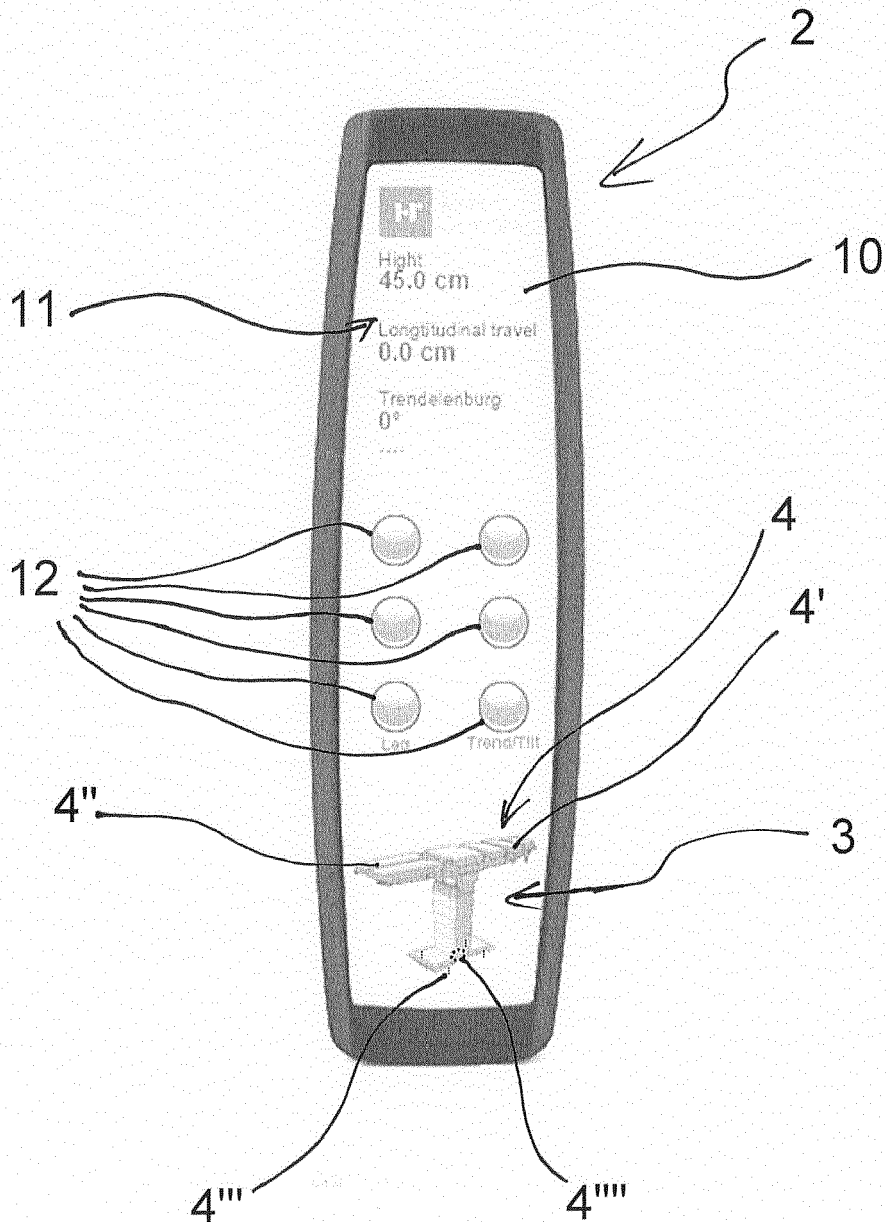
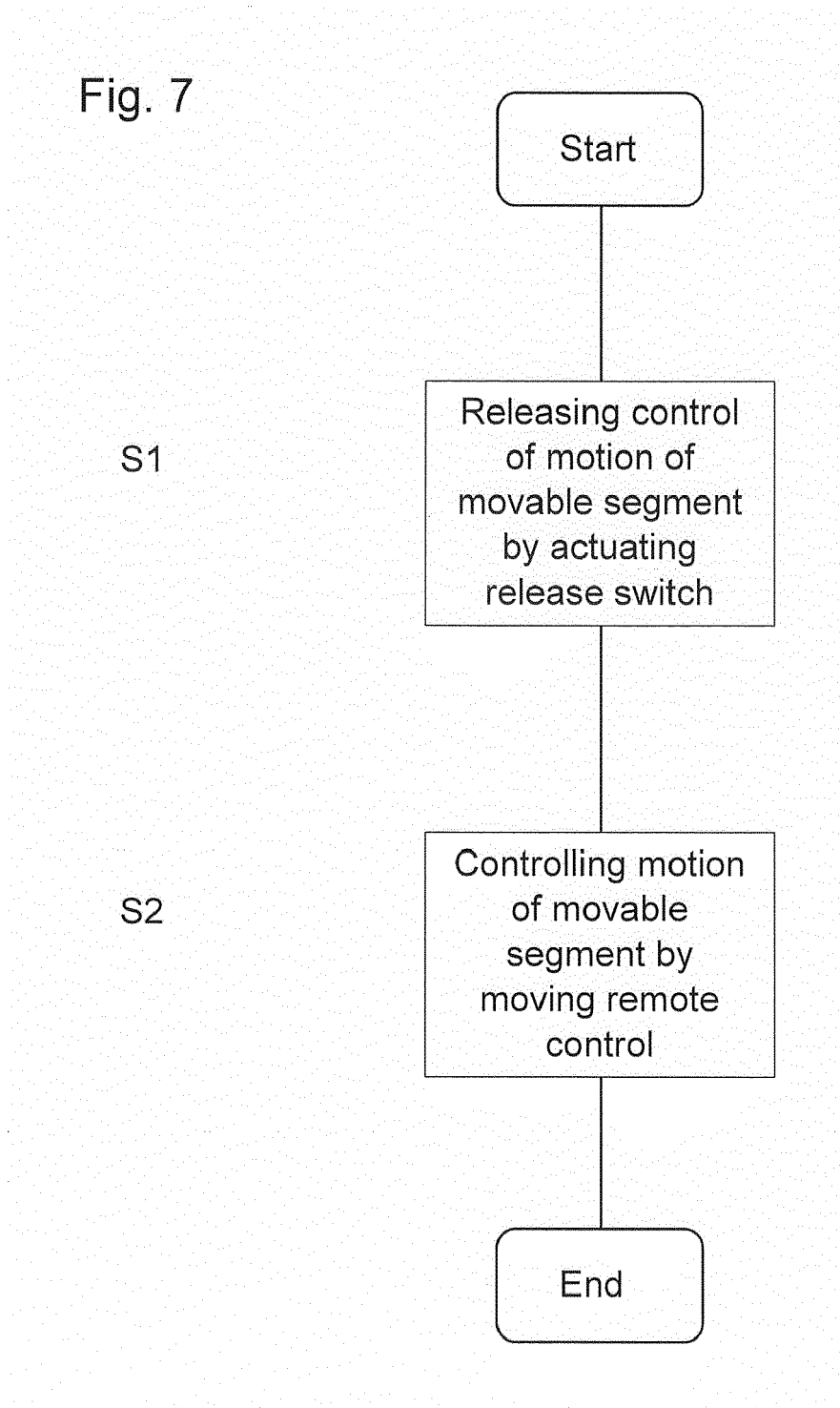

Fig. 7





EUROPEAN SEARCH REPORT

Application Number
EP 19 20 3771

5

10

15

20

25

30

35

40

45

50

55

DOCUMENTS CONSIDERED TO BE RELEVANT			
Category	Citation of document with indication, where appropriate, of relevant passages	Relevant to claim	CLASSIFICATION OF THE APPLICATION (IPC)
X	US 2009/126115 A1 (DOERING ULRICH [DE] ET AL) 21 May 2009 (2009-05-21)	1-4, 7-13, 16-18	INV. A61G13/08
Y	* paragraphs [0013] - [0032] *	5,6,14, 15	
X	US 2015/245965 A1 (GRIESEL ANDRE [DE] ET AL) 3 September 2015 (2015-09-03)	1-4, 7-10,13, 16-18	
Y	* paragraphs [0028] - [0029]; figure 3, *	5,6	
Y	US 2017/196748 A1 (GAISER IMMANUEL [DE]) 13 July 2017 (2017-07-13)	14,15	TECHNICAL FIELDS SEARCHED (IPC) A61G
Y	* paragraphs [0064] - [0076]; figure 4 *		
The present search report has been drawn up for all claims			
Place of search The Hague		Date of completion of the search 28 July 2020	Examiner Kroeders, Marleen
CATEGORY OF CITED DOCUMENTS X : particularly relevant if taken alone Y : particularly relevant if combined with another document of the same category A : technological background O : non-written disclosure P : intermediate document		T : theory or principle underlying the invention E : earlier patent document, but published on, or after the filing date D : document cited in the application L : document cited for other reasons & : member of the same patent family, corresponding document	

EPO FORM 1503 03.02 (P04C01)



5

CLAIMS INCURRING FEES

The present European patent application comprised at the time of filing claims for which payment was due.

10

Only part of the claims have been paid within the prescribed time limit. The present European search report has been drawn up for those claims for which no payment was due and for those claims for which claims fees have been paid, namely claim(s):

15

No claims fees have been paid within the prescribed time limit. The present European search report has been drawn up for those claims for which no payment was due.

20

LACK OF UNITY OF INVENTION

The Search Division considers that the present European patent application does not comply with the requirements of unity of invention and relates to several inventions or groups of inventions, namely:

25

see sheet B

30

All further search fees have been paid within the fixed time limit. The present European search report has been drawn up for all claims.

35

As all searchable claims could be searched without effort justifying an additional fee, the Search Division did not invite payment of any additional fee.

40

Only part of the further search fees have been paid within the fixed time limit. The present European search report has been drawn up for those parts of the European patent application which relate to the inventions in respect of which search fees have been paid, namely claims:

45

None of the further search fees have been paid within the fixed time limit. The present European search report has been drawn up for those parts of the European patent application which relate to the invention first mentioned in the claims, namely claims:

50

55

The present supplementary European search report has been drawn up for those parts of the European patent application which relate to the invention first mentioned in the claims (Rule 164 (1) EPC).



**LACK OF UNITY OF INVENTION
SHEET B**

Application Number
EP 19 20 3771

5

The Search Division considers that the present European patent application does not comply with the requirements of unity of invention and relates to several inventions or groups of inventions, namely:

10

1. claims: 1-13, 16-18

Remote control for controlling a medical apparatus having a driven movable component, comprising:

15

A) sensor (position and motion)
B) release switch
C) produces control signal for component, which is released upon releasing B)
wherein the problem/solution is intended to be related to positioning of a patient surface (see figures of the application)

20

1.1. claims: 1-4, 7-13

with the additional features of adjusting the signal C) solving the problem of providing control over the intensity of the motion of the component

25

1.2. claims: 1, 5, 6

with the additional features of a touch screen D) solving the problem of providing alternative input means

30

2. claims: 1, 13-15

Remote control for controlling a medical apparatus (specifically, an operating table) having a driven movable component, comprising:

35

A) sensor (position and motion)
B) release switch
C) produces control signal for component
D) control signal released upon releasing B)
with the additional features of locking motion of the operating table
solving the problem of preventing undesired relocation of the operating table (e.g. requiring a mobility/transportation system E))

40

45

Please note that all inventions mentioned under item 1, although not necessarily linked by a common inventive concept, could be searched without effort justifying an additional fee.

50

55

ANNEX TO THE EUROPEAN SEARCH REPORT
ON EUROPEAN PATENT APPLICATION NO.

EP 19 20 3771

5

This annex lists the patent family members relating to the patent documents cited in the above-mentioned European search report. The members are as contained in the European Patent Office EDP file on The European Patent Office is in no way liable for these particulars which are merely given for the purpose of information.

28-07-2020

10

15

20

25

30

35

40

45

50

55

Patent document cited in search report	Publication date	Patent family member(s)	Publication date
US 2009126115 A1	21-05-2009	DE 102007055465 A1	20-05-2009
		EP 2060248 A2	20-05-2009
		JP 2009165105 A	23-07-2009
		US 2009126115 A1	21-05-2009

US 2015245965 A1	03-09-2015	DE 102012220667 A1	15-05-2014
		US 2015245965 A1	03-09-2015
		WO 2014076096 A1	22-05-2014

US 2012118718 A1	17-05-2012	CN 102891674 A	23-01-2013
		EP 2455959 A1	23-05-2012
		US 2012118718 A1	17-05-2012

US 2017196748 A1	13-07-2017	BR 112017007007 A2	26-12-2017
		CN 107072629 A	18-08-2017
		DE 102014115901 A1	04-05-2016
		EP 3212146 A1	06-09-2017
		JP 2017536150 A	07-12-2017
		KR 20170080641 A	10-07-2017
		RU 2017118400 A	04-12-2018
		US 2017196748 A1	13-07-2017
WO 2016066436 A1	06-05-2016		

EPO FORM P0459

For more details about this annex : see Official Journal of the European Patent Office, No. 12/82

REFERENCES CITED IN THE DESCRIPTION

This list of references cited by the applicant is for the reader's convenience only. It does not form part of the European patent document. Even though great care has been taken in compiling the references, errors or omissions cannot be excluded and the EPO disclaims all liability in this regard.

Patent documents cited in the description

- EP 2455959 A1 [0002]