

(12) INTERNATIONAL APPLICATION PUBLISHED UNDER THE PATENT COOPERATION TREATY (PCT)

(19) World Intellectual Property Organization
International Bureau



(43) International Publication Date
12 July 2001 (12.07.2001)

PCT

(10) International Publication Number
WO 01/50412 A1

- (51) International Patent Classification⁷: G06K 15/10, B41J 2/21
- (21) International Application Number: PCT/US00/33964
- (22) International Filing Date: 15 December 2000 (15.12.2000)
- (25) Filing Language: English
- (26) Publication Language: English
- (30) Priority Data: 09/477,265 4 January 2000 (04.01.2000) US
- (71) Applicant: ENCAD, INC. [US/US]; 6059 Cornerstone Court West, San Diego, CA 92121 (US).
- (72) Inventor: HAFLINGER, James; 4956 Sandshore Court, San Diego, CA 92130 (US).
- (74) Agent: ARNO, Thomas, R.; Knobbe, Martens, Olson & Bear, LLP, 16th Floor, 620 Newport Center Drive, Newport Beach, CA 92660 (US).
- (81) Designated States (*national*): AE, AG, AL, AM, AT, AT (utility model), AU, AZ, BA, BB, BG, BR, BY, BZ, CA, CH, CN, CR, CU, CZ, CZ (utility model), DE, DE (utility model), DK, DK (utility model), DM, DZ, EE, EE (utility model), ES, FI, FI (utility model), GB, GD, GE, GH, GM, HR, HU, ID, IL, IN, IS, JP, KE, KG, KP, KR, KZ, LC, LK, LR, LS, LT, LU, LV, MA, MD, MG, MK, MN, MW, MX, MZ, NO, NZ, PL, PT, RO, RU, SD, SE, SG, SI, SK, SK (utility model), SL, TJ, TM, TR, TT, TZ, UA, UG, UZ, VN, YU, ZA, ZW.
- (84) Designated States (*regional*): ARIPO patent (GH, GM, KE, LS, MW, MZ, SD, SL, SZ, TZ, UG, ZW), Eurasian patent (AM, AZ, BY, KG, KZ, MD, RU, TJ, TM), European patent (AT, BE, CH, CY, DE, DK, ES, FI, FR, GB, GR, IE,

[Continued on next page]

(54) Title: PRINT MASKS FOR HIGH SPEED INK JET PRINTING

(57) Abstract: A method of ink jet printing uses only selected nozzles of a print head to reduce the time required to print onto pixel locations as the print head is scanned over the surface of a piece of media. Print carriage speed during printing may thus be increased.

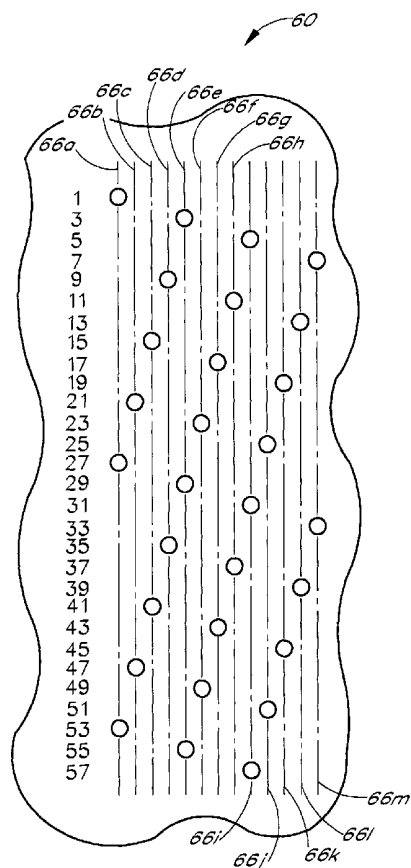

WO 01/50412 A1



IT, LU, MC, NL, PT, SE, TR), OAPI patent (BF, BJ, CF, CG, CI, CM, GA, GN, GW, ML, MR, NE, SN, TD, TG).

For two-letter codes and other abbreviations, refer to the "Guidance Notes on Codes and Abbreviations" appearing at the beginning of each regular issue of the PCT Gazette.

Published:

- *With international search report.*
- *Before the expiration of the time limit for amending the claims and to be republished in the event of receipt of amendments.*

PRINT MASKS FOR HIGH SPEED INK JET PRINTINGBackground of the Invention

In on-demand ink jet printing, a grid of pixel locations is defined on a print media surface. During the print process, each pixel location may receive a droplet of ink from a set of ink ejection nozzles on a print head as the print head passes horizontally over the print media surface. In many systems, the pixel grid may be considered to comprise a series of vertical columns of pixel positions, and the ejection nozzles are also functionally organized as a vertical column. The vertical spacing between nozzles corresponds to the vertical pixel spacing, which will typically be approximately 50 to 600 pixels per inch, resulting in a vertical inter-nozzle spacing of about 40 to 500 microns. As the vertical column of nozzles passes over each vertical column of pixel locations, the appropriate droplets are deposited. In some printers, known as "page wide" printers, the vertical column of nozzles spans one dimension of the image, and image generation is performed by incrementing the media beneath the print head in the orthogonal dimension. In most printer designs, however, the vertical column of nozzles is much shorter in length than the total number of pixels in a vertical pixel column of the whole image, and the nozzles are mounted on a moveable print carriage. In these printer embodiments, the print head is sequentially passed over one horizontally extending swath of the image at a time, and the media is incremented between each pass.

It has been found that the print quality of images produced by moving carriage printers is improved dramatically with the use of "multi-pass" print techniques. In these print methods, portions of the nozzle column pass over the same segment of media two, four, six, or even more times, with each pass laying down a fraction of the ink droplets required to complete a swath. This technique avoids several print quality problems that are associated with depositing a large amount of ink in a single pass of the print head.

Unfortunately, however, with the same print carriage speed, the increased quality of four or six pass print modes comes at the price of a four or six fold increase in print time. Unless the print carriage speed is increased, therefore, the additional passes result in a severe reduction of printer throughput.

The speed at which the print head travels is limited by two factors. The first is the fact that a given nozzle can only be fired at a pre-determined maximum rate. In a single pass mode, therefore, the carriage cannot travel over more pixel columns per second than the maximum firing rate of the nozzles. This limitation is not a significant concern with the use of multi-pass print modes, however, because the nozzles can be programmed to skip certain pixels on certain passes. In a two-pass print mode, for example, the carriage speed can be doubled over the single pass speed because it is possible to ensure that a given nozzle only prints on at most every other pixel location as it passes over the pixel columns.

Although it first appears that increasing the number of passes in a multi-pass print mode would always allow a corresponding increase in print head speed, this is not the case because of a second factor which limits print head speed. This factor is the additional minimum time required to deposit ink onto any individual one of the pixel columns. One reason for this minimum time is that in most print head designs, the vertical column of nozzles is actually arranged

as a horizontally spaced series of sub-columns. These sub-column arrangements are used because the simultaneous firing of too many nozzles, especially adjacent nozzles, is undesirable. In thermally activated print heads, for example, the firing of too many nozzles simultaneously results in a large power dissipation which is expensive to supply and which causes an excessive temperature increase in the print head. In addition, in both thermally and piezoelectrically actuated print heads, the firing of one or a set of nozzles may cause droplet volume and velocity changes or may otherwise interfere with the firing of other nozzles of the print head.

In one commercially available thermal print head from Lexmark Corp., for example, a nozzle array of 208 nozzles is divided into two separate columns of 104 nozzles, with each of the two columns being further arranged as 13 horizontally adjacent sub-columns of 8 nozzles each. As a column of nozzles passes over a pixel column, the 13 sub-columns are enabled sequentially as they become approximately centrally positioned over the pixel column. With this print head, each nozzle requires about 3 micro seconds to deposit an ink droplet. The nozzle column must therefore remain over each pixel column for at least about $13 \times 3 = 39$ microseconds. If the pixel columns are 1/600 inches wide (i.e., the printer is a 600 dpi printer), the maximum speed of the print head over the media is about 40 inches per second. It has therefore been found that carriage speed in four, six, or eight pass print modes, for example, cannot be increased significantly above what is possible in two pass mode. The increase in quality provided by the additional passes results in a proportional increase in the time it takes to print an image. Increases in carriage speed are thus highly desirable, as they would allow improvement in printer throughput without sacrificing print quality.

Summary of the Invention

In one embodiment, a method of increasing the speed of multi-pass printing onto a series of adjacent pixel columns with an ink jet print head is provided. The ink jet print head comprises a plurality of sub-columns of ink ejection nozzles actuated by a corresponding plurality of address lines, and the method comprises asserting only a pre-defined subset of the address lines within each of the pixel columns.

Embodiments of ink jet printers are also provided. In one advantageous embodiment, an ink jet printer comprises processing and logic circuitry for controlling ink ejection by selectively asserting address and power lines of an ink jet print head in accordance with print data and a print mask. The printer further comprises a memory coupled to the processing and logic circuitry for storing the print mask. The print mask defines a droplet deposition pattern for each nozzle which guarantees, regardless of print data content, that at most only approximately half of the address lines will be required to be asserted as the print head passes over each pixel column of the image being printed. This makes it unnecessary to move the print head slow enough to assert all of the address lines over each pixel column and thus allows for a higher print head speed over the print media.

Brief Description of the Drawings

FIG. 1 is a front view of a floor standing ink jet printer in which the invention finds advantageous application.

FIG. 2 is a block diagram of internal ink jet printer components.

FIG. 3 is a plan view of one exemplary embodiment of an ink jet print head showing one specific 208 nozzle array configuration.

FIG. 4 is a close-up view of the print head of FIG. 3 within the area designated 4-4 in FIG. 3.

FIG. 5 is a schematic diagram of power and address lines used to actuate the nozzles of FIGs. 3 and 4.

FIGs. 6A and 6B are charts of nozzle assignments to power and address lines for the 208 nozzle print head of FIG. 3.

FIG. 7 illustrates the droplet deposition onto a raster line of an image in an eight pass mode using print masks in accordance with one embodiment of the invention.

FIG. 8 illustrates print masks for nozzles 21, 45, 69, 93, 117, 141, 165, and 189 of the 208 nozzle print head of FIG. 3 in accordance with an eight pass embodiment of the invention.

FIGs. 9A-9F shows eight pass print masks for each of the 192 utilized nozzles of the 208 nozzle print head of FIG. 3 in accordance with one embodiment of the invention.

Detailed Description of the Preferred Embodiment

Embodiments of the invention will now be described with reference to the accompanying Figures, wherein like numerals refer to like elements throughout. The terminology used in the description presented herein is not intended to be interpreted in any limited or restrictive manner, simply because it is being utilized in conjunction with a detailed description of certain specific embodiments of the invention. Furthermore, embodiments of the invention may include several novel features, no single one of which is solely responsible for its desirable attributes or which is essential to practicing the inventions herein described.

The invention has application to ink jet printers and printing methods, and accordingly, Figure 1 illustrates one possible ink jet printer configuration which may embody the invention. The specific embodiment of Figure 1 is a floor standing printer 10 comprising a platen 12 forming a printing surface. The printer also comprises a print carriage 14 which traverses horizontally across the platen 12 in the direction of arrow 15. Installed in the print carriage 14 are a plurality of ink jet print heads 16, which selectively eject ink droplets downward onto the print surface. Ink ejection is controlled by the printer to deposit ink droplets onto selected pixel locations of a grid of pixel locations having a given dot-per-inch (dpi) resolution in the horizontal and vertical dimensions. The grid of pixel locations defines a series of vertically extending pixel columns and horizontally extending pixel rows. The pixel rows which extend horizontally, parallel to carriage 14 travel, are often referred to as raster lines. Each print head 16 receives ink from an ink reservoir 18 through an associated ink feed tube 20. During print operations, a media drive system advances a piece of media across the print surface in a direction perpendicular to the direction of carriage 14 travel (that is, into or out of the plane of Figure 1) in between horizontal passes of the print carriage over the media surface. This process builds an image from a series of deposited swaths of ink droplets.

These aspects of ink jet printers are well known and conventional, and a wide variety of alternative configurations exists. For example, the print surface 12 could be placed in any orientation with respect to the floor. It will accordingly be appreciated that the terms horizontal and vertical as used herein merely refer to any two substantially perpendicular directions. Consistent with convention, "vertical" is generally used herein to denote the direction of media travel during printing, and "horizontal" is generally used herein to denote the direction of carriage travel during printing, regardless of how these operations are oriented with respect to, for example, the floor of the room the printer stands on. It will also be appreciated that non-moving print heads may be used in page wide printing, wherein one or more ink jet print heads span the entire page width and printing is performed as the media is advanced beneath. The print heads may be drop-on-demand print heads which are thermally actuated or piezoelectrically actuated. In all of these embodiments, however, the print heads 16 comprise nozzle arrays for selectively ejecting droplets of ink onto the desired pixel locations at the resolution for which printer performance was designed. Specific nozzle arrays for which the invention finds especially advantageous application are illustrated in Figures 3 and 4.

Referring now to Figure 2, various components of a typical inkjet printer 28, having a host computer 30 coupled thereto, is illustrated. These various components include control electronics of the ink jet printer which are used to control ink droplet ejection from the ink jet nozzles of a print head 32. A host computer 30 communicates with a processor 34 integral with the ink jet printer 28. The host computer 30 runs driver software which issues print commands and sends data to the ink jet printer 28. As is conventional in ink jet printers, the processor 34 communicates with a display and keypad 36, memory 38, and drive circuits 40 which control the print carriage motor 42 and paper motor 44 as well as powering a fan 46. In addition, the processor 34 routes signals to print logic 50, which actuates the ink jet nozzles of the ink jet print head 32.

The processor 34, in accordance with internal firmware stored in a portion of the memory 38, selectively ejects ink droplets from the nozzles of the ink jet print head of each cartridge. The programming of the processor thus determines which nozzle of the print head is assigned to be used to eject an ink droplet onto any given grid location of the printed image when the relevant swath being printed calls for a droplet at that given grid location. In multi-pass printing, the set of nozzle to grid location assignments is commonly referred to as a print mask, and the print mask definition is stored in memory 38 in the ink jet printer. The function and operation of a print mask is described in further detail below with reference to Figures 7 and 8.

Referring now to Figure 3, the face of a print head 56 is illustrated which includes two vertical columns 58, 60 of nozzles. Each nozzle 62 communicates with an ink reservoir which replenishes the ink after a nozzle has ejected an ink droplet.

In the illustrated embodiment, each of the columns 58, 60 have 104 nozzles. As will be explained in further detail below, and as is best illustrated in Figure 4, the nozzles of each vertical column 58, 60 are not exactly vertically aligned, but are arranged into a plurality of horizontally spaced sub-columns. Although this multiple sub-column arrangement is important to printer operation, the horizontal displacement is relatively small compared to the vertical separation between nozzles. In one commercially available print head, the nozzles in each column provide a 300 dots-per-

inch (dpi) resolution, so that the vertical distance between vertically adjacent nozzles is 1/300 inches or about 85 microns. In this embodiment the horizontal distance between horizontally adjacent sub-columns is a little over 3 microns such that the total horizontal distance between the leftmost sub-column and the rightmost sub-column is less than a 1/600 inch horizontal pixel spacing.

5 The vertical nozzle positions for the two columns 58, 60 are vertically interleaved by one pixel spacing each, whereas the vertical nozzle spacing within each column is two vertical pixel spacings. The horizontal separation designated by arrow 64 between each column is generally much larger than the vertical nozzle separations, and may be 8, 16 or more horizontal pixel spacings. This horizontal separation is typically a selected integer number of horizontal pixel spacings, however, so that during the print process, the columns of nozzles 58, 60 cross over different vertical pixel
10 columns simultaneously. The interleaving produces an overall vertical print resolution of double the nozzles per inch provided in any one column 58, 60. In the embodiment of Figure 3, if each column 58, 60 were 300 nozzles per inch, the print head would print a vertically extending swath having a height of 208 600 dpi pixels as it traveled across the media. As shown in Figure 3, it is conventional to number the nozzles according to their vertical position on the print head. Due to the interleaved nozzle positions in each column, this results in nozzle 1 being in the right column 60, nozzle 2 in the left
15 column 58, nozzle 3 in the right column 60, nozzle 4 in the left column 58, and so on, such that all odd numbered nozzles are in the right column 60 and all the even numbered nozzles are in the left column 58.

Figure 4 shows a close up views of the top 29 nozzles of the rightmost column 60 of Figure 3, which comprises all odd numbered nozzles through nozzle 57. As can be seen in these Figures, the column of nozzles 60 is organized as thirteen separate sub-columns, designated 64a-64m in Figure 4. For purposes of clarity of illustration, the horizontal scale
20 of this Figure is not the same as the vertical scale. The horizontal sub-column spacing is shown larger in Figure 4 relative to vertical nozzle spacings than is actually the case. At the top of each sub-column is one of the first thirteen odd numbered nozzles. Following the top nozzle, each sub-column includes every thirteenth following odd nozzle. Thus, the first sub-column 64a begins with nozzle 1, the next nozzle of this column is nozzle 27, then nozzle 53, etc. In the embodiment of Figure 4, the second column 64b begins with nozzle 21 of the column, and continues with nozzle 47, and
25 so on.

As the print head passes rightward over a vertical column of pixels, the nozzles in sub-column 64m are enabled first as this sub-column is the first one to be properly positioned. Similarly, sub-columns 64l, 64k, and so on through 64a are successively enabled as they are successively positioned approximately over the center of the vertical pixel column. Following ink ejection from sub-column 64a, sub-column 64m is enabled as this sub-column becomes centrally positioned
30 over the next adjacent vertical pixel column. Therefore, even when depositing droplets on every pixel in a vertical column, only a subset (about one-thirteenth) of the nozzles is ever fired simultaneously.

Figure 5 shows a schematic of nozzle actuation electronics which may be used to perform this sequential sub-column firing. The circuitry shown in Figure 5 is advantageously implemented on an integrated circuit. The circuit shown may be used to actuate the two column array of 208 nozzles illustrated in Figure 3 and 4. As shown in Figure 5, the
35 circuit is best illustrated as a grid of sixteen power lines (denoted P1-P16) and thirteen address lines (denoted A1-A13).

The power lines P1-P16 are each connected to a source of power 70 through a separate switch 72. The address lines A1-A13 are each connected to ground 76 through another set of respective switches 74. Each switch 72, 74 is typically implemented as a transistor which is selectively switched into an on state by print head control logic. If a switch 72, 74 associated with a given power or address line is in an on state, that power line or address line is referred to herein as "asserted". Ink is ejected from a selected nozzle when the power and address lines associated with that nozzle are asserted by the print head control logic.

To perform the sequential sub-column actuation described above, each address line is associated with one sub-column. Address line A1, for example, is connected to all the nozzles positioned in sub-column 64a of Figure 4. This is illustrated in Figure 5 by the nozzle numbers 1, 27, 53, 79, 105, 131, 157, and 183 being associated with node locations connected to line A1 of that Figure. Address line A1 is also associated with the first sub-column of the leftmost column 58 of Figure 3, which contains even numbered nozzles 20, 46, 72, 98, 124, 150, 176, and 202. During printing, as the sub-columns of nozzles pass over a pixel column, A1 is asserted, and then selected power lines are asserted. A2 is then asserted, and another set of power lines is asserted. As one illustrative example, if the twelfth pixel of the thirty-seventh raster line is to receive an ink droplet in a particular pass of the print head across the media, line A8 is asserted just prior to asserting P3 as the right column 60 (which contains nozzle 37) passes over the twelfth pixel column. In typical prior art printers, all thirteen address lines are sequentially asserted (or "strobed") as the nozzle column passes over each pixel column. As described briefly above, to eject an ink droplet, an address line must be asserted for about three microseconds. Strobing all thirteen address lines with each pixel column puts an upper bound on print head speed over the media if ink droplets are to be placed on the pixel column. Additional information concerning the structure and operation of thermal ink jet print heads built in accordance with these general principles may be found in U.S. Patent No. 5,648,805 to Keefe et al., the disclosure of which is hereby incorporated by reference in its entirety.

Figures 6A and 6B show the nozzle assignments to power and address lines for the commercially available 208 nozzle print head array arranged as described above with reference to Figures 3 and 4. By locating a selected nozzle on the table of Figure 6A, the correct address to be asserted is determined. Locating the same nozzle on the table of Figure 6B, the correct power line to assert is determined.

Referring now to Figures 7 and 8, however, it will be demonstrated that with the careful preparation of multi-pass print masks for the ink ejection nozzles, it can be guaranteed that only a known subset of the address strobes will need to be made over each pixel column. By skipping the remaining unused address strobes over each pixel column, the three microseconds each for these strobes is no longer needed, and print speed may be substantially increased.

The general principles of multi-pass printing are well understood by those of skill in the art and are thus not described in detail herein. In general, multi-pass printing involves distributing ink droplet deposition to each raster line of the image between several different nozzles of the ink jet print head. In an eight pass print mode, for example, each nozzle associated with a selected raster line may be assigned to deposit ink onto about 1/8 of the pixel locations of the raster line. In one simple embodiment, a first nozzle may be assigned to pixel locations 1, 9, 17, 25, 33, and so

on. A second nozzle may be assigned to pixel locations 2, 10, 18, 26, 34, and so on. With eight nozzles assigned to the raster line of pixel locations, each nozzle thus prints on one out of eight pixel locations to complete the raster line.

In Figure 7, one possible droplet deposition pattern for eight pass printing is illustrated. In this Figure, the first 32 pixel locations of a raster line 80 are illustrated. The masks repeat for each additional 32 pixel segment across the width of the image. During, for example, a complete color fill of the raster line, the first pass will deposit ink onto locations 2, 8, 26, and 30 of the raster line 80 as indicated by the filled circles at these positions. During the second pass, ink is deposited onto positions 1, 15, 23, and 31. As shown by the other filled circles in passes 3 through 8, the raster line is filled in completely over the course of the eight passes by depositing ink in four of the 32 positions (that is, one-eighth of the positions) with each pass.

The print masks illustrated in Figure 7 may be advantageously used in conjunction with the print head described with reference to Figures 3-6 in order to substantially increase the speed of the print carriage over the media. This is illustrated in Figure 8. In this embodiment, printing is accomplished by using 192 of the 208 nozzles, and incrementing the media in 24 nozzle width increments. With this procedure, bands of raster lines which are 24 lines wide will pass first under nozzles 1-24, then under nozzles 25-48, and then sequentially under nozzles 49-72, 73-96, 97-120, 121-144, 145-168, and 169-192 to complete the eight passes. Thus, each raster line will be passed over by eight nozzles during this process. For example, nozzles 1, 25, 49, 73, 97, 121, 145, and 169 are assigned to print one raster line of every 24. As another example, nozzles 21, 45, 69, 93, 117, 141, 165, and 189 are assigned to deposit ink onto another set of raster lines which are spaced 24 raster lines apart. This is the nozzle group illustrated in Figure 8.

Referring now to Figure 8, a raster line 82 on the media is first vertically aligned beneath nozzle 21 of the ink jet print head. If the image requires ink to be printed on a pixel location for which the twenty-first jet is responsible, indicated by the filled circles in selected pixel locations, this dot is printed during the first pass of the print head.

After printing to these pixels, the recording media is advanced by an amount equal to the width of 24 raster lines, such that the raster line 82 is now vertically aligned with nozzle 45. Now the raster line 82, which has been partially printed on by jet number 21, is printed on, as required by the print data, by nozzle 45 of the print head during a second pass of the print head over the recording medium. The recording media is then once again advanced by an amount equal to the height of twenty-four raster lines. The raster line 82 is now aligned with the sixty-ninth jet of the print head, and is printed upon, as necessary, in accordance with another jet mask during a third pass of the print head over the recording medium. The above-described process is repeated until drops required to be printed in the raster line have been deposited by additional nozzles 93, 117, 141, 165, and 189. As is understood by those in the art, an eight pass mode with a 24 nozzle increment with each pass requires the definition of 24 groups of eight print masks. Each print mask is applied to one of eight nozzles in each group of eight nozzles assigned to print individual raster lines. As in Figures 7 and 8, each group of eight print masks distributes the pixel locations of a raster line between the eight nozzles of each group. During printing, of course, all nozzles of the ink jet print head are simultaneously depositing ink according to the print data and their associated print mask.

In the specific embodiment of Figure 8, the twenty-four nozzle media advance per pass, together with the print masks used for nozzles 21, 45, 69, 93, 117, 141, 165, and 189 are selected such that when the ink jet cartridge described above with reference to Figures 3-6 is used, only half of the address strobes need to be asserted over each pixel location. As shown in Figure 6, nozzles 21, 117, 141, and 165 are associated with address lines 2, 12, 8, and 4 respectively. These are all even numbered address lines. Nozzles 45, 69, 93 and 189 are associated with address lines 11, 7, 3, and 13 respectively. These are all odd numbered address lines. To reduce the number of address strobes which need to be made at each pixel location of the raster line, even pixel numbers, that is, pixels 2, 4, 6, 8, etc. from left to right, are printed with nozzles associated with even address lines. Furthermore, odd pixel numbers, that is, pixels numbered 1, 3, 5, 7, etc. from left to right are printed with nozzles associated with odd address lines. In the case of the eight nozzle group of Figure 8, this means that only nozzles 21, 117, 141, and 165 are used to print onto even pixels and only nozzles 45, 69, 93, and 189 are used to print onto odd pixels. This design is implemented in the eight print masks shown in Figure 8. Nozzle 21, for example, which is coupled to an even address line, is assigned to print pixels 2, 8, 26, and 30, which are all even pixels. Nozzle 45, which is coupled to an odd address line, is assigned to print pixels 1, 15, 23, and 31, which are all odd pixels. With these print masks, only odd address lines will need to be asserted over odd pixels, and only even address lines will need to be asserted over even pixels. It will be appreciated that the even/odd pixel column assignments could be reversed such that even addresses are asserted over odd pixel columns and odd address lines are asserted over even pixel columns. Thus, with such print masks used with the print head of Figures 3-6, only six or seven address strobes, rather than thirteen, need to be made over each pixel, allowing almost a doubling of carriage speed without a significant sacrifice to print quality. Of course, Figure 8 shows only one of the 24 nozzle groups which are used in this eight pass mode. To achieve the potential increase in carriage speed, the print masks for each of the 24 groups of eight nozzles must be designed with the same principles described above which are used to construct the print masks of Figure 8 for nozzles 21, 45, 69, 93, 117, 141, 165, and 189. In table format, set forth below are the nozzles which can be used for pixel columns assigned to even address strobes and pixel columns assigned to odd address strobes for each of the 24 nozzle groups in the eight pass mode of Figure 8.

Nozzle Group	Nozzle Choices For Even Address Pixel Columns	Nozzle Choices For Odd Address Pixel Columns
1	25, 49, 73, 169	1, 97, 121, 145
2	2, 122, 146, 170	26, 50, 74, 98
3	51, 75, 99	3, 27, 123, 147, 171
4	4, 28, 148, 172	52, 76, 100, 124
5	77, 101, 125	5, 29, 53, 149, 173
6	6, 30, 54, 174	78, 102, 126, 150
7	103, 127, 151	7, 31, 55, 79, 175
8	32, 56, 80	8, 104, 128, 152, 176
9	9, 129, 153, 177	33, 57, 81, 105
10	58, 82, 106	10, 34, 130, 154, 178
11	11, 35, 155, 179	59, 83, 107, 131
12	84, 108, 132	12, 36, 60, 156, 180
13	13, 37, 61, 181	85, 109, 133, 157
14	14, 110, 134, 158	38, 62, 86, 182
15	39, 63, 87	15, 111, 135, 159, 183
16	16, 40, 136, 160, 184	64, 88, 112
17	65, 89, 113	17, 41, 137, 161, 185
18	18, 42, 66, 162, 186	90, 114, 138
19	91, 115, 139	19, 43, 67, 163, 187
20	44, 68, 92, 188	20, 116, 140, 164
21	21, 117, 141, 165	45, 69, 93, 189
22	70, 94, 118	22, 46, 142, 166, 190
23	23, 47, 143, 167, 191	71, 95, 119
24	96, 120, 144	24, 48, 72, 168, 192

TABLE I

5 Construction of a print mask for each of the 192 utilized nozzles (24 groups of eight) may be done by selecting only those nozzles listed above for even and odd pixels respectively of each raster line, as done with nozzle group 21 illustrated in Figure 8. When this is done, printing each pixel column requires alternately strobing either only even address lines, or only odd address lines. For the print head of Figures 3-6, such print masks will guarantee that no more than 7 address lines need to be asserted over any pixel column as the print head passes over the media. Physically, this means that interleaved alternate sets of nozzle sub-columns are being used to deposit ink droplets in alternating pixel columns. Referring to the nozzle arrangement of Figure 4, for example, during the print process, odd pixel columns only receive ink droplets from sub-columns 64a, 64c, 64e, 64g, 64i, 64k, and 64m. Even pixel columns only receive ink droplets from sub-columns 64b, 64d, 64f, 64h, 64j, and 64l.

15 It can be appreciated from the above discussion that the appropriate division of even and odd pixel locations between the nozzles of a group is dependent on the specific arrangement of nozzles on the print head and their assignment to different address lines. Which nozzles make up a group depends on the number of passes and the number of nozzle positions per media increment between passes. Once the nozzles in each group are identified, they can then be separated

into two sets depending on whether they are connected to an odd or even address line. Even and odd pixel positions in a raster line can then be assigned to the nozzles according to their membership in the even or odd set of nozzles within the group of nozzles.

Several additional print mask principles are also preferably observed during the print mask design process. The first is that no nozzle should eject an ink droplet onto pixel locations which are less than four pixel positions apart in the raster line. This prevents firing a nozzle faster than its rated duty cycle even when the carriage speed is increased in accordance with the invention. Also, vertically adjacent nozzles should not be fired on the same pass. With the cartridge embodiment of Figures 3-6, following this rule is not difficult, because vertically adjacent nozzles tend to be associated with alternating even and odd address lines.

Figures 9A to 9F illustrate the print masks for each of the 192 utilized nozzles of the 208 jet print head of Figures 3-6 constructed in one embodiment of the invention in accordance with these principles. As discussed above, the masks repeat for each set of 32 pixel columns across the width of the printed image. With these masks, no two vertically adjacent nozzles print vertically adjacent pixel locations, and at least three pixel locations are provided between each assigned print location within a raster line. In addition, by referring to Figures 9A-9F in conjunction with Figure 6A, it can be seen that the nozzles assigned to print alternate pixel columns are fired by asserting alternately either only even address lines or only odd address lines. For example, nozzles 4, 9, 11, 13, 16, 21, 25, 30, 39, 44, 47, 56, 65, 75, 77, 82, 94, 108, 110, 115, 120, 127, 170, and 186 are assigned to print onto pixel column number 1. Referring to Figure 6A, it is found that all of these nozzles are coupled to even address lines. Furthermore, nozzles 1, 10, 20, 22, 27, 29, 31, 33, 36, 38, 41, 43, 45, 52, 59, 71, 78, 85, 88, 90, 98, 104, and 111 are assigned to print onto pixel column number 2. Again referring back to Figure 6A, all of these nozzles are fired by asserting odd address lines. Thus, as described above, only even addresses are strobed over pixel column 1, only odd addresses are strobed over pixel column 2, and so on across the image.

In color ink jet printers, it is common to have four ink jet cartridges with their nozzle arrays spaced apart by an integer number of pixel locations. Because each address line is typically tied in parallel to all of the cartridges, each cartridge must be firing even or odd address lines at the same time. Thus, the integer number of pixel locations separating the cartridges is preferably an even number so that all nozzle columns pass over even or odd pixel columns simultaneously. If two cartridges are an odd number of pixel positions apart, this can be compensated for by rotating leaf masks for one of the cartridges by one bit left or right.

Several modifications to the above described methods and systems may be utilized. For example, even though nozzle separation based on even and odd address line connection is advantageous for some cartridges (such as the cartridge described with reference to Figures 3-6), it is possible that address/nozzle assignments may result in an uneven distribution of nozzles between even and odd sets for some raster lines. In some cases, it is possible that all the jets in a particular group are connected to only even address lines, only odd address lines, or perhaps only to a single one of the address lines. This issue may be resolved in two possible ways. First, there may be a different allocation of address lines to two sets that makes the nozzle assignments come out more evenly. Instead of even/odd division of address lines, the

two sets may be address lines 1, 4, 5, 6, 9, 11, 12 for even pixel columns and 2, 3, 7, 8, 10, 13 for odd pixel columns. As another alternative, the amount of media increment between passes can be selected to produce advantageous nozzle groupings for the raster lines. For example, in the case of a 26 nozzle increment in an eight pass mode with the print head of Figures 3-6, the first nozzle group is made up of nozzles 1, 27, 53, 79, 105, 131, 157, and 183. As shown in Figure 6,
5 all of these nozzles are connected to address line 1. The same single address line connection is true for the other nozzle groups of this embodiment. Thus, if this increment is used, all thirteen address strobes need to be asserted with each pixel column. This problem has been solved in the embodiment of Figure 8 and Table 1 by using a 24 nozzle increment rather than a 26 nozzle increment. As set forth above, this makes the first nozzle group into nozzles 1, 25, 49, 73, 97,
10 121, 145, and 169. This group of nozzles is evenly split between even and odd address lines.

10 The foregoing description details certain embodiments of the invention. It will be appreciated, however, that no matter how detailed the foregoing appears in text, the invention can be practiced in many ways. As is also stated above, it should be noted that the use of particular terminology when describing certain features or aspects of the invention should not be taken to imply that the terminology is being re-defined herein to be restricted to including any specific characteristics of the features or aspects of the invention with which that terminology is associated. The scope of the
15 invention should therefore be construed in accordance with the appended claims and any equivalents thereof.

WHAT IS CLAIMED IS:

1. A method of increasing the throughput of an ink jet printer, wherein:

(1) the ink jet printer comprises an array of ink ejection nozzles arranged as a plurality of spaced apart sub-columns;

5 (2) the ink jet printer deposits ink droplets onto a series of adjacent pixel columns as the array moves with respect to the series of adjacent pixel columns,

(3) wherein the spaced apart sub-columns are sequentially actuated as the nozzle array passes over each one of pixel columns to deposit ink onto the pixel locations therein,

10 (4) and wherein the throughput of the printer is limited by the time required to actuate all of the sub-columns as the array passes over each one of the pixel columns;

said method of increasing the printer throughput comprising:

separating said sub-columns into two groups, a first group comprising selected ones of said spaced apart sub-columns, and a second group comprising the remaining sub-columns; and

15 alternating ink droplet deposition between said first and second groups of sub-columns as said array moves such that alternating pixel columns are printed with alternating first and second groups of sub-columns, whereby only the first or second group of sub-columns, rather than all of the sub-columns, are required to be actuated over any individual pixel column.

2. An ink jet printer that prints images on print media by depositing ink droplets onto a two-dimensional grid of pixel locations, said grid defining a series of vertically extending pixel columns and a series of horizontally extending raster lines, said ink jet printer being configured to print in a multi-pass mode for high quality printing at a high throughput rate, said ink jet printer comprising:

20 a horizontally moveable print head comprising an array of ink ejection nozzles, wherein said print head and said array of nozzles have the following features:

25 (1) said array of ink ejection nozzles is arranged into at least one vertically extending column of ink ejection nozzles such that as said print head passes horizontally over said print media each ink ejection nozzle passes over one of said horizontally extending raster lines;

(2) wherein each one of said ink ejection nozzles is coupled to a power line and an address line, and wherein each nozzle ejects an ink droplet only when both said power line and said address line are asserted;

30 (3) wherein said vertically extending column of ink ejection nozzles is further arranged into a plurality of vertically extending sub-columns of ink ejection nozzles that are horizontally spaced apart from one another;

(4) wherein all nozzles in the same sub-column are coupled to a common address line, and wherein nozzles in different sub-columns are coupled to different address lines;

(5) wherein the horizontal distance between a leftmost and a rightmost sub-column defines a nozzle column width which is less than the width of one of said pixel columns;

(6) and wherein as the print head passes horizontally over said print media, said vertically extending sub-columns become sequentially vertically aligned with the centers of the vertically extending pixel columns such that said address lines may be sequentially asserted as the nozzle column passes over each pixel column to enable ink droplet deposition from one sub-column at a time;

said ink jet printer further comprising:

processing and logic circuitry for controlling ink ejection by selectively asserting said address and power lines in accordance with print data and a print mask;

a memory coupled to said processing and logic circuitry and storing said print mask, wherein said print mask defines a droplet deposition pattern for each nozzle which guarantees, regardless of print data content, that at most only approximately half of said address lines will be required to be asserted as said print head passes over each pixel column, thereby making it unnecessary to move the print head slow enough to assert all of said address lines over each pixel column and thus allowing for a higher print head speed over the print media.

3. A method of depositing ink droplets onto a grid of pixel locations comprising a series of adjacent pixel columns with an array of ink ejection nozzles, wherein said array of ink ejection nozzles is configured in a plurality of spaced apart sub-columns, said method comprising depositing ink droplets onto pixels of a first pre-defined subset of said adjacent pixel columns using only nozzles positioned in a first pre-defined subset of said plurality of spaced apart sub-columns.

4. The method of Claim 3, additionally comprising depositing ink droplets onto pixels in a second pre-defined subset of said adjacent pixel columns using only nozzles positioned in a second pre-defined subset of said plurality of spaced apart sub-columns.

5. The method of Claim 4, wherein said second pre-defined subset of said plurality of spaced apart sub-columns includes no sub-columns in common with said first pre-defined subset.

6. The method of Claim 5, wherein said first pre-defined subset of said plurality of spaced apart sub-columns comprises approximately one half of said plurality of spaced apart sub-columns and wherein said second pre-defined subset of said plurality of spaced apart sub-columns comprises the remainder of said plurality of spaced apart sub-columns.

7. An ink jet printer for printing onto a print media having defined thereon a series of adjacent pixel columns defining a two-dimensional grid of pixel locations, said ink jet printer comprising:

a moveable print head comprising an array of ink ejection nozzles, wherein said array of ink ejection nozzles are arranged into a plurality of sub-columns aligned parallel to said pixel columns such that

said sub-columns pass sequentially over a segment of each pixel column as said print head is passed over said print media;

data processing circuitry for controlling ink ejection from said array of ink ejection nozzles;

a memory coupled to said data processing circuitry and storing a print mask used by said data processing circuitry to control ink ejection, wherein said print mask defines a droplet deposition pattern for each nozzle which guarantees that only an identical pre-defined subset of said sub-columns of nozzles to deposit ink onto each of said pixel columns.

5

10

8. A method of increasing the throughput of an ink jet printer having a moving print carriage mounting at least one ink jet print head having an array of ink ejection nozzles thereon for selectively printing onto a set of pixel columns on print media, said method comprising controlling ink ejection from an array of nozzles on said ink jet print head with a multi-pass print mask such that (1) only a first pre-defined portion of said ink ejection nozzles are enabled for ink ejection over a first pre-defined set of said pixel columns, and such that (2) only a second pre-defined portion of said ink ejection nozzles are enabled for ink ejection over a second pre-defined set of said pixel columns.

15

9. The method of Claim 8, wherein said array of ink ejection columns is arranged as a series of alternating odd and even sub-columns, wherein said set of pixel columns is arranged as a series of alternating odd and even pixel columns, wherein only nozzles positioned in said odd sub-columns are enabled for printing onto pixels positioned in said odd pixel columns and wherein only nozzles positioned in said even sub-columns are enabled for printing onto pixels positioned in even pixel columns.

20

10. A method of increasing the speed of multi-pass printing onto a series of adjacent pixel columns with an ink jet print head, said ink jet print head comprising a plurality of sub-columns of ink ejection nozzles actuated by a corresponding plurality of address lines, said method comprising asserting only a pre-defined subset of said address lines within each of said pixel columns.

25

11. A method of ink jet printing onto a plurality of pixel columns using an array of ink ejection nozzles arranged in a plurality of spaced apart sub-columns, said method comprising:

depositing ink droplets onto a first pixel column using only nozzles positioned in a first pre-defined subset of said spaced apart sub-columns;

depositing ink droplets onto a second pixel column adjacent to said first pixel column using only nozzles positioned in sub-columns different from said first pre-defined subset of said spaced apart sub-columns.

30

12. The method of Claim 11, additionally comprising depositing ink droplets onto a third pixel column adjacent to said second pixel column using only nozzles positioned in said first pre-defined subset of said spaced apart sub-columns.

35

13. The method of Claim 12, additionally comprising depositing ink droplets onto a fourth pixel column adjacent to said third pixel column using only nozzles positioned in sub-columns different from said first pre-defined subset of said spaced apart sub-columns.

14. A method of increasing the throughput of an ink jet printer, wherein said ink jet printer comprises an array of ink ejection nozzles arranged as a plurality of spaced apart sub-columns, and wherein said array of ink ejection nozzles deposits ink droplets onto a series of adjacent pixel columns as said array moves with respect to said series of adjacent pixel columns, said method comprising:
- 5 separating said sub-columns into a plurality of groups of sub-columns;
 assigning each pixel column to one of said groups; and
 depositing ink droplets in accordance with said separating and said assigning such that each pixel column receives ink droplets only from its assigned group of sub-columns.
15. The method of Claim 14, wherein each sub-column is a member of exactly one group.
- 10 16. The method of Claim 14, comprising separating said sub-columns into two, three, or four groups.
17. The method of Claim 14, comprising separating said sub-columns into two groups.
18. The method of Claim 14, wherein said separating comprises separating said sub-columns into first and second groups of sub-columns, with each group each having approximately equal numbers of sub-columns.
19. The method of Claim 18, wherein said assigning comprises assigning every other pixel column to
- 15 said first group, and the remaining pixel columns to said second group.

1/16

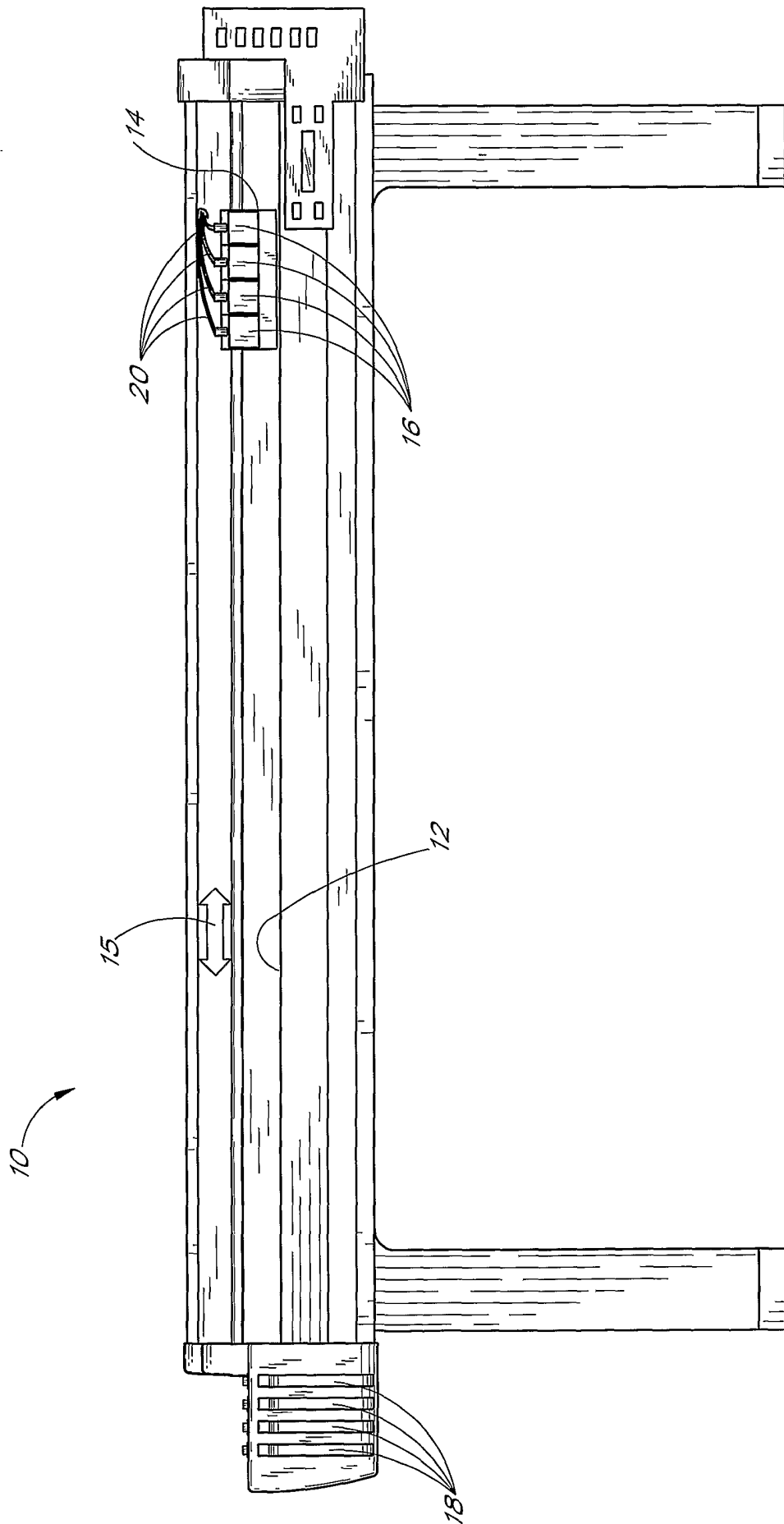

FIG. 1

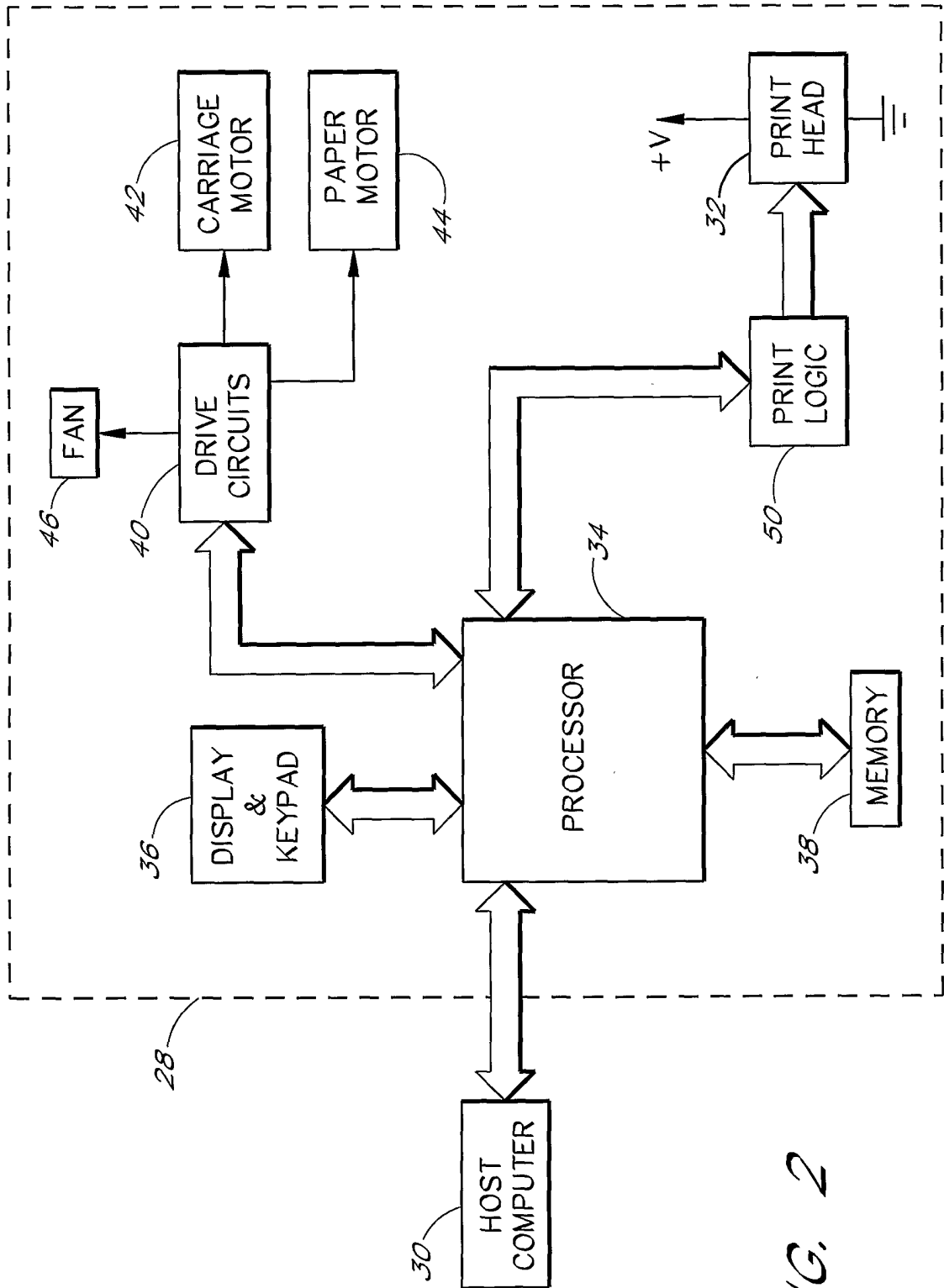

FIG. 2

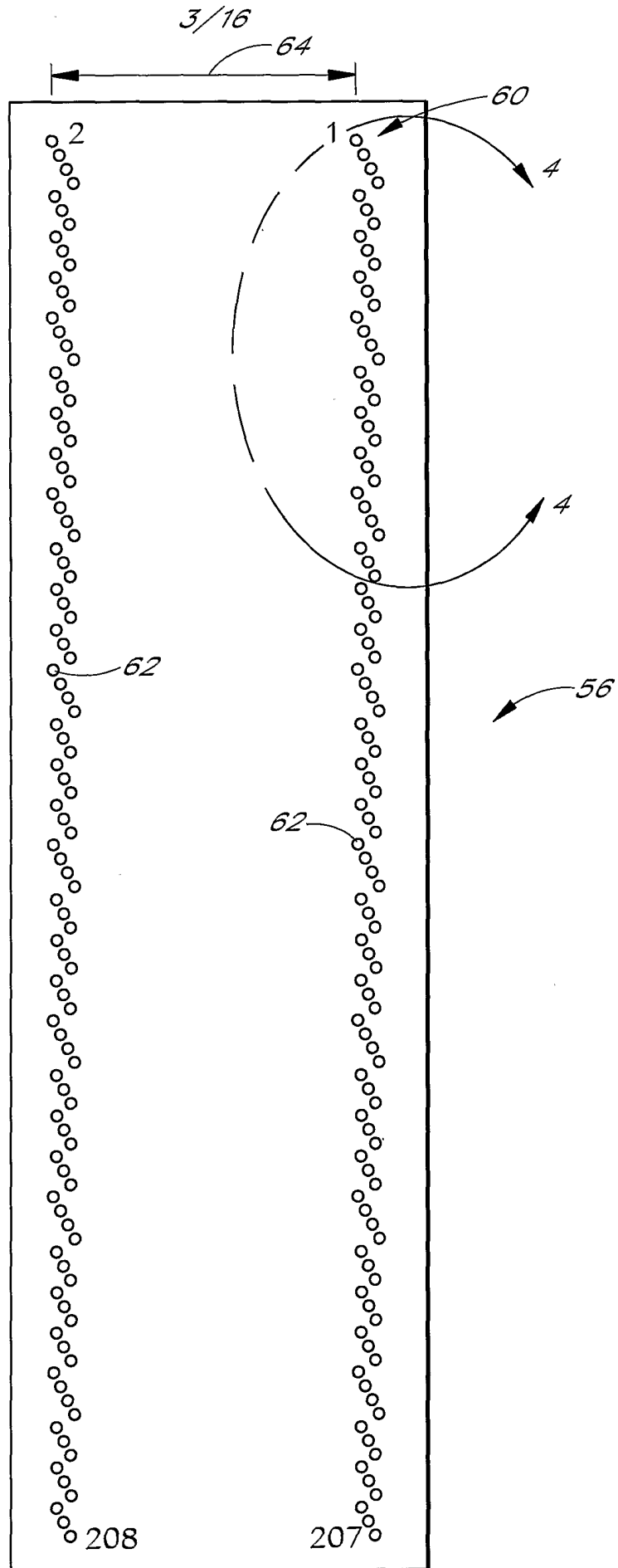

FIG. 3

4/16

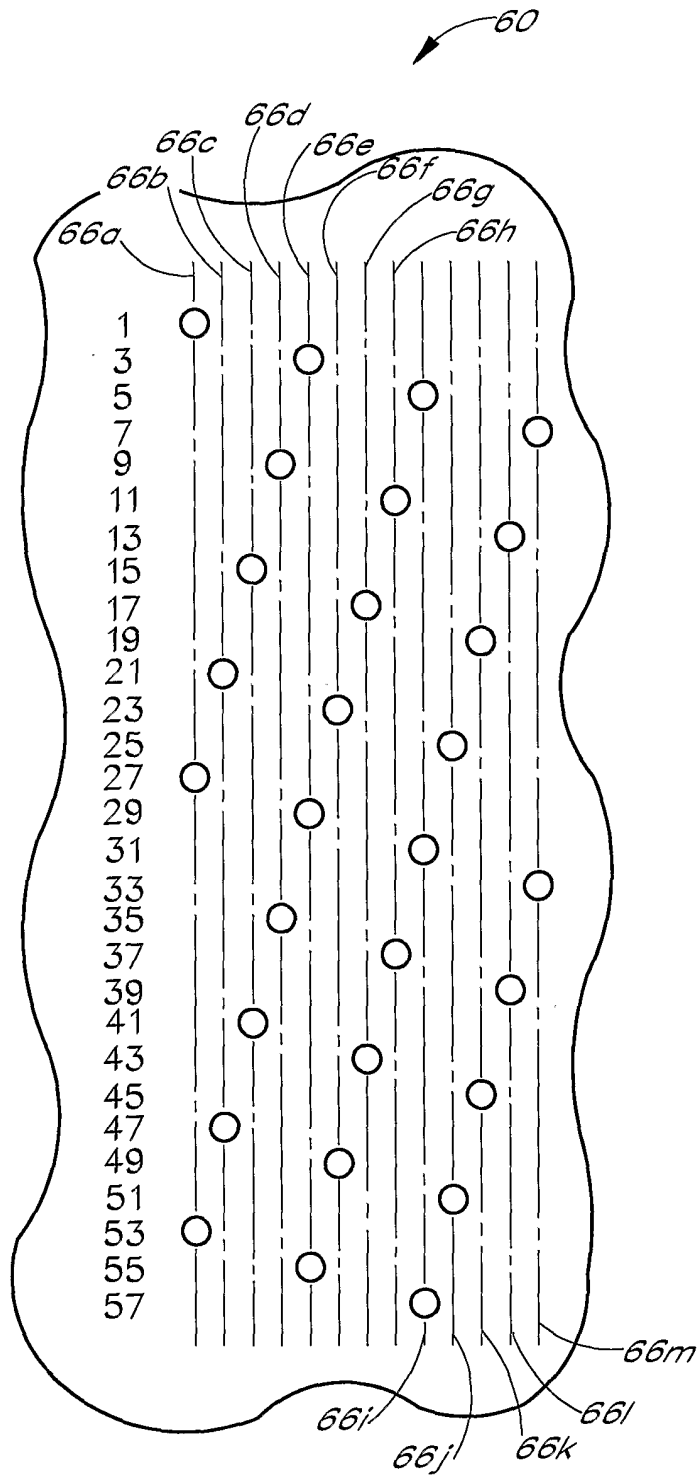

FIG. 4

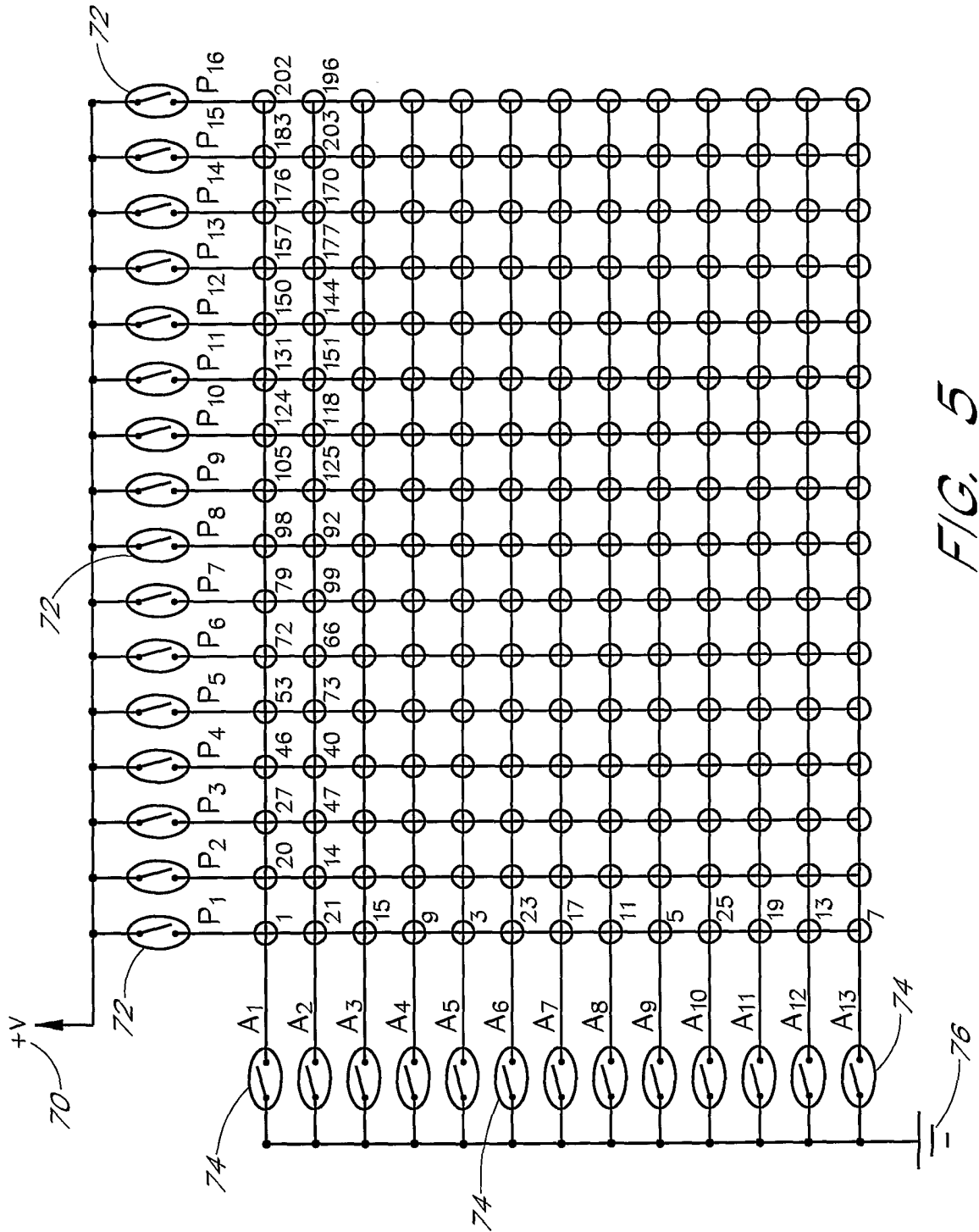

FIG. 5

6/16

ADDRESS LINE

1	2	3	4	5	6	7	8	9	10	11	12	13
1	14	8	2	3	16	10	4	5	18	12	6	7
20	21	15	9	22	23	17	11	24	25	19	13	26
27	40	34	28	29	42	36	30	31	44	38	32	33
46	47	41	35	48	49	43	37	50	51	45	39	52
53	66	60	54	55	68	62	56	57	70	64	58	59
72	73	67	61	74	75	69	63	76	77	71	65	78
79	92	86	80	81	94	88	82	83	96	90	84	85
98	99	93	87	100	101	95	89	102	103	97	91	104
105	118	112	106	107	120	114	108	109	122	116	110	111
124	125	119	113	126	127	121	115	128	129	123	117	130
131	144	138	132	133	146	140	134	135	148	142	136	137
150	151	145	139	152	153	147	141	154	155	149	143	156
157	170	164	158	159	172	166	160	161	174	168	162	163
176	177	171	165	178	179	173	167	180	181	175	169	182
183	196	190	184	185	198	192	186	187	200	194	188	189
202	203	197	191	204	205	199	193	206	207	201	195	208

FIG. 6A

7/16

POWER LINE

16	15	14	13	12	11	10	9	8	7	6	5	4	3	2	1
184	183	158	157	132	131	106	105	80	79	54	53	28	27	2	1
186	185	160	159	134	133	108	107	82	81	56	55	30	29	4	3
188	187	162	161	136	135	110	109	84	83	58	57	32	31	6	5
190	189	164	163	138	137	112	111	86	85	60	59	34	33	8	7
192	191	166	165	140	139	114	113	88	87	62	61	36	35	10	9
194	193	168	167	142	141	116	115	90	89	64	63	38	37	12	11
196	195	170	169	144	143	118	117	92	91	66	65	40	39	14	13
198	197	172	171	146	145	120	119	94	93	68	67	42	41	16	15
200	199	174	173	148	147	122	121	96	95	70	69	44	43	18	17
202	201	176	175	150	149	124	123	98	97	72	71	46	45	20	19
204	203	178	177	152	151	126	125	100	99	74	73	48	47	22	21
206	205	180	179	154	153	128	127	102	101	76	75	50	49	24	23
208	207	182	181	156	155	130	129	104	103	78	77	52	51	26	25

FIG. 6B

9/16

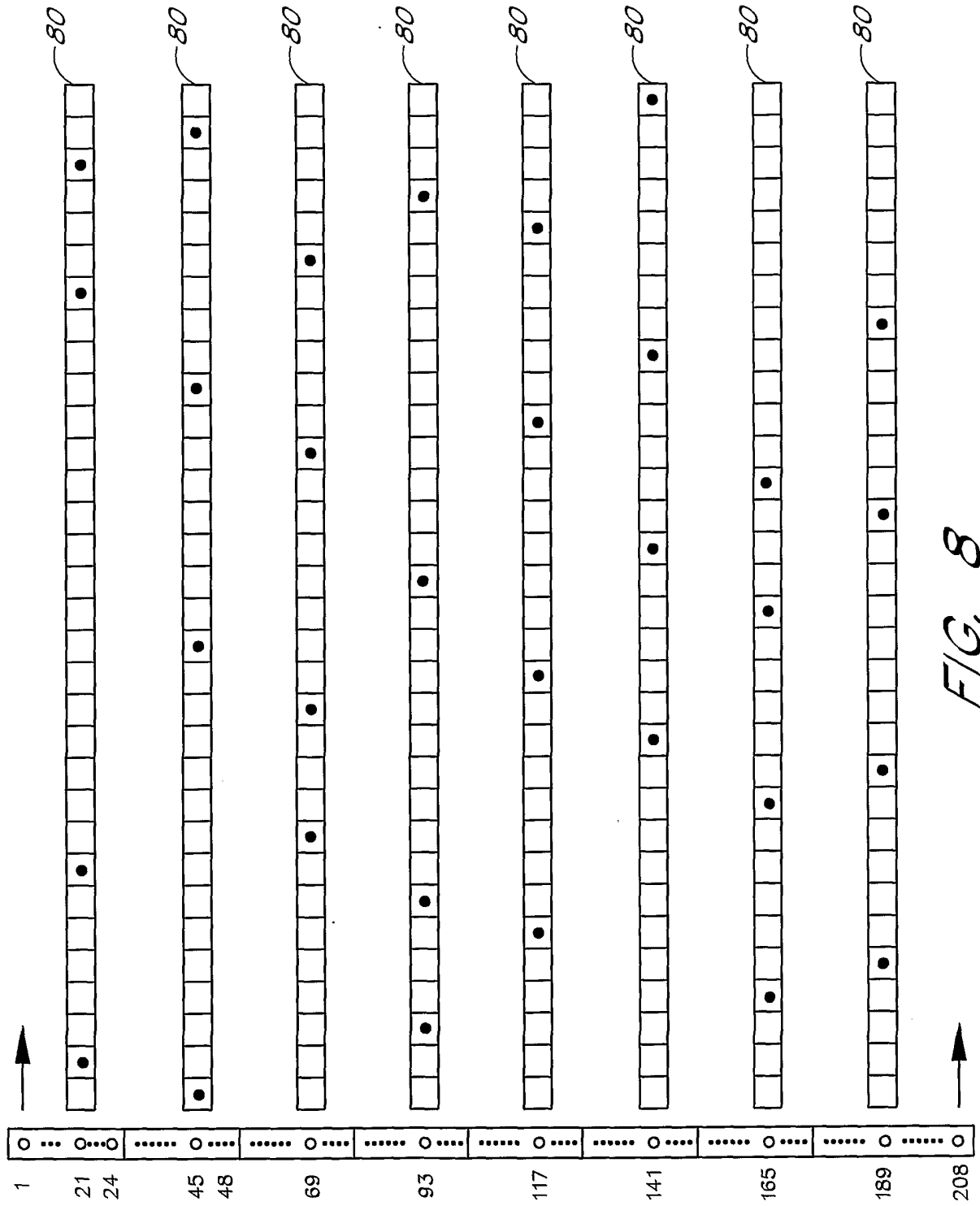

FIG. 8

10/16

FIG. 9

FIG. 9A	FIG. 9B	FIG. 9C	FIG. 9D	FIG. 9E	FIG. 9F
---------	---------	---------	---------	---------	---------

11/16

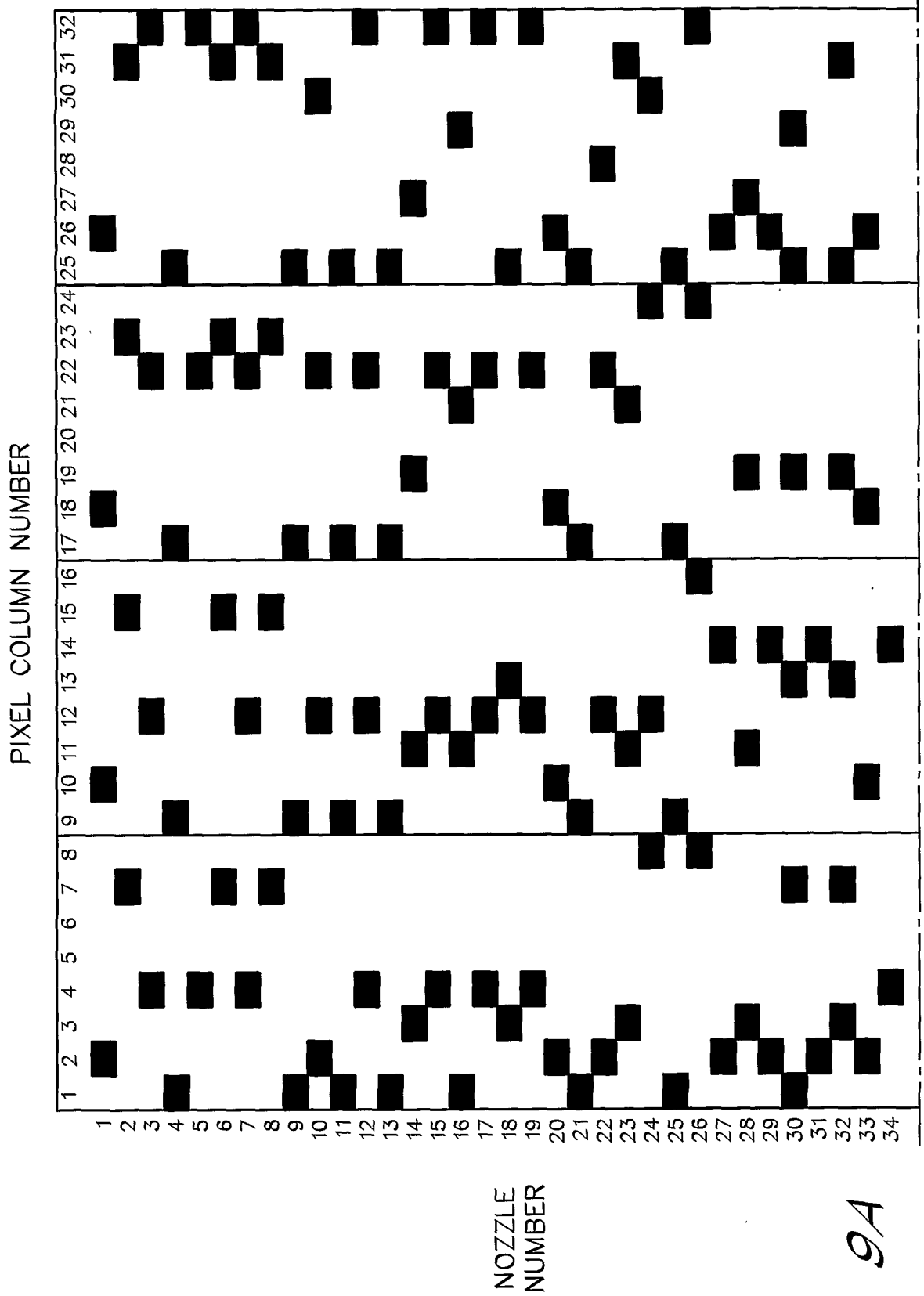

FIG. 9A

12/16

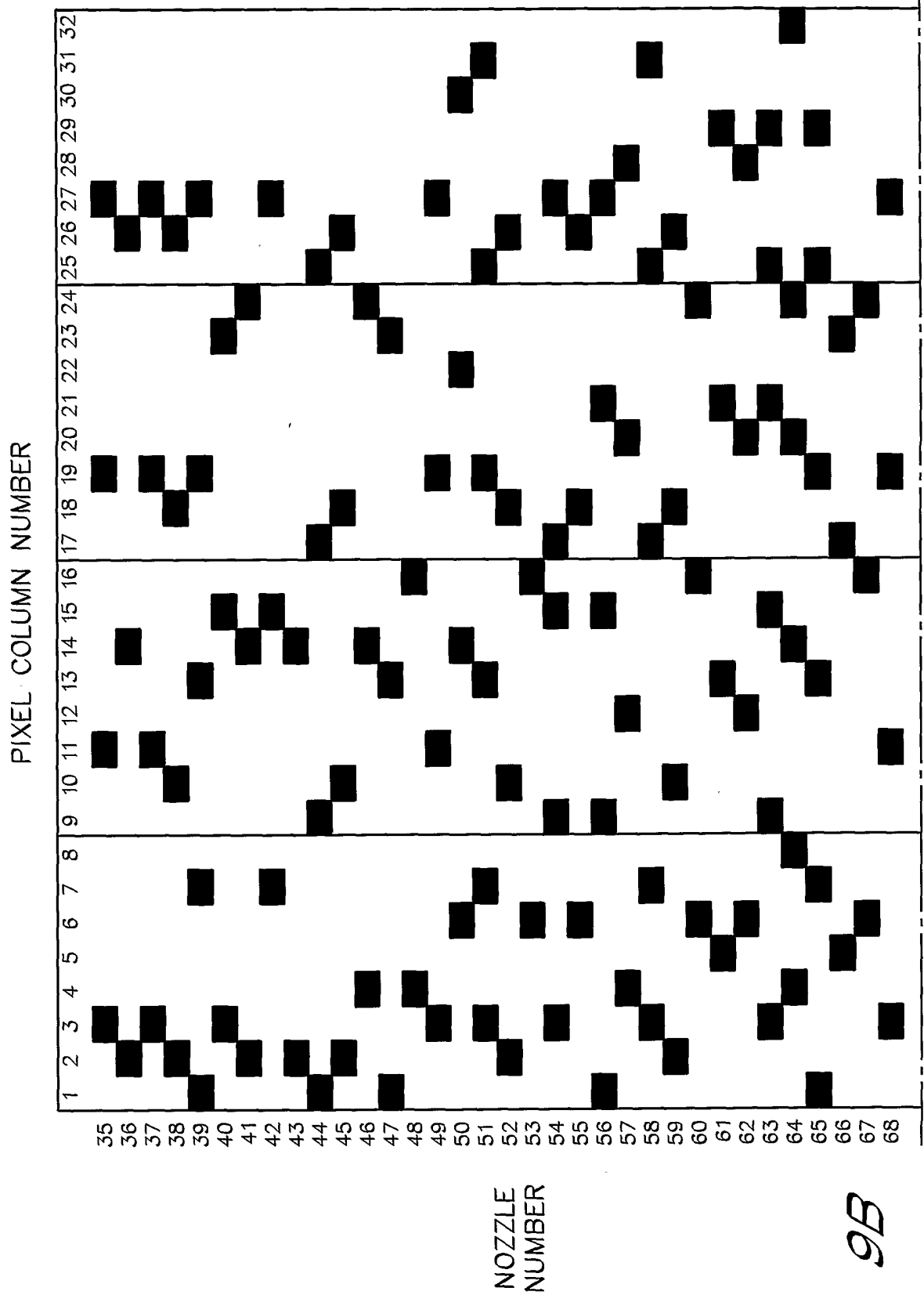

FIG. 9B

13/16

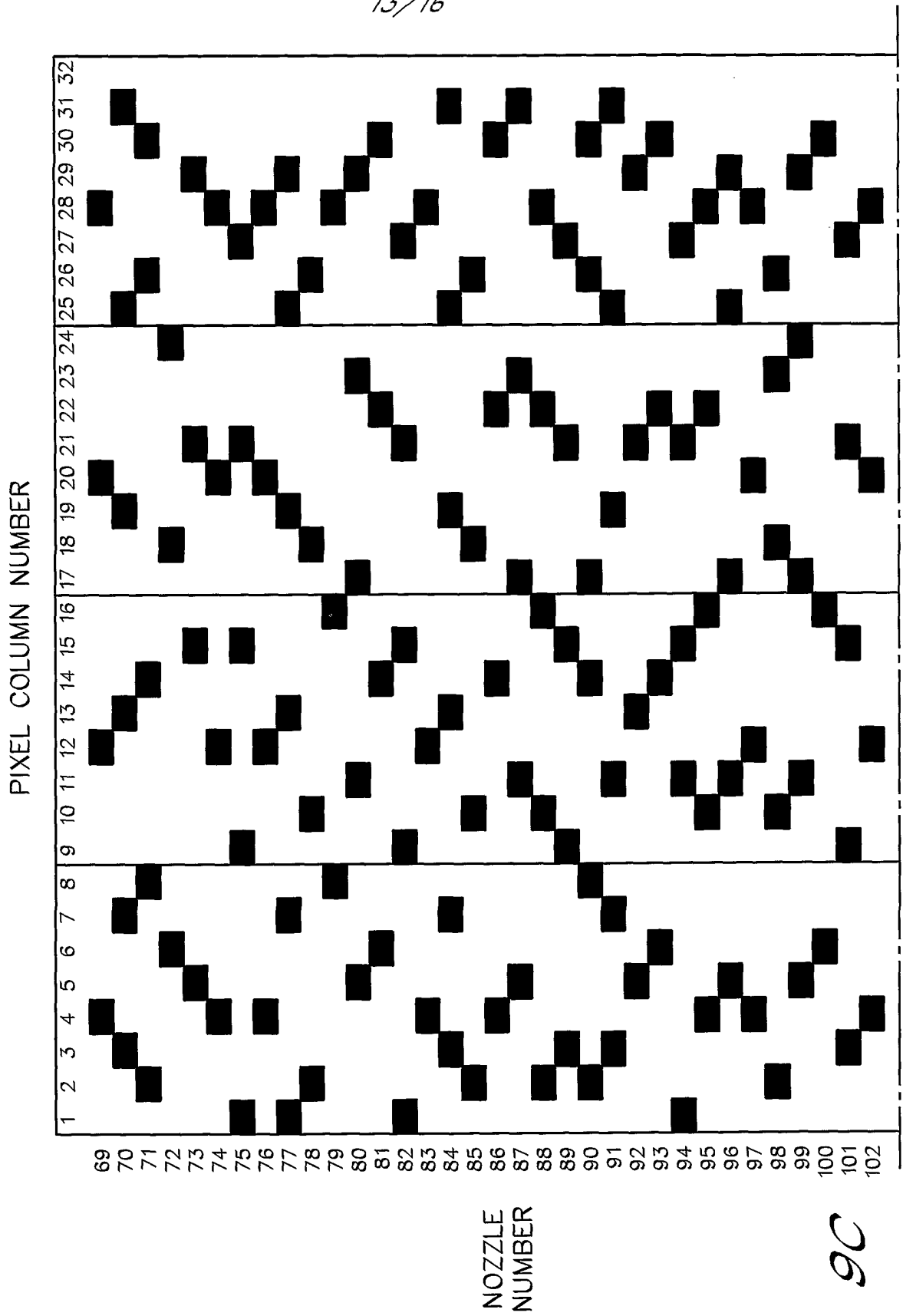

FIG. 9C

14/16

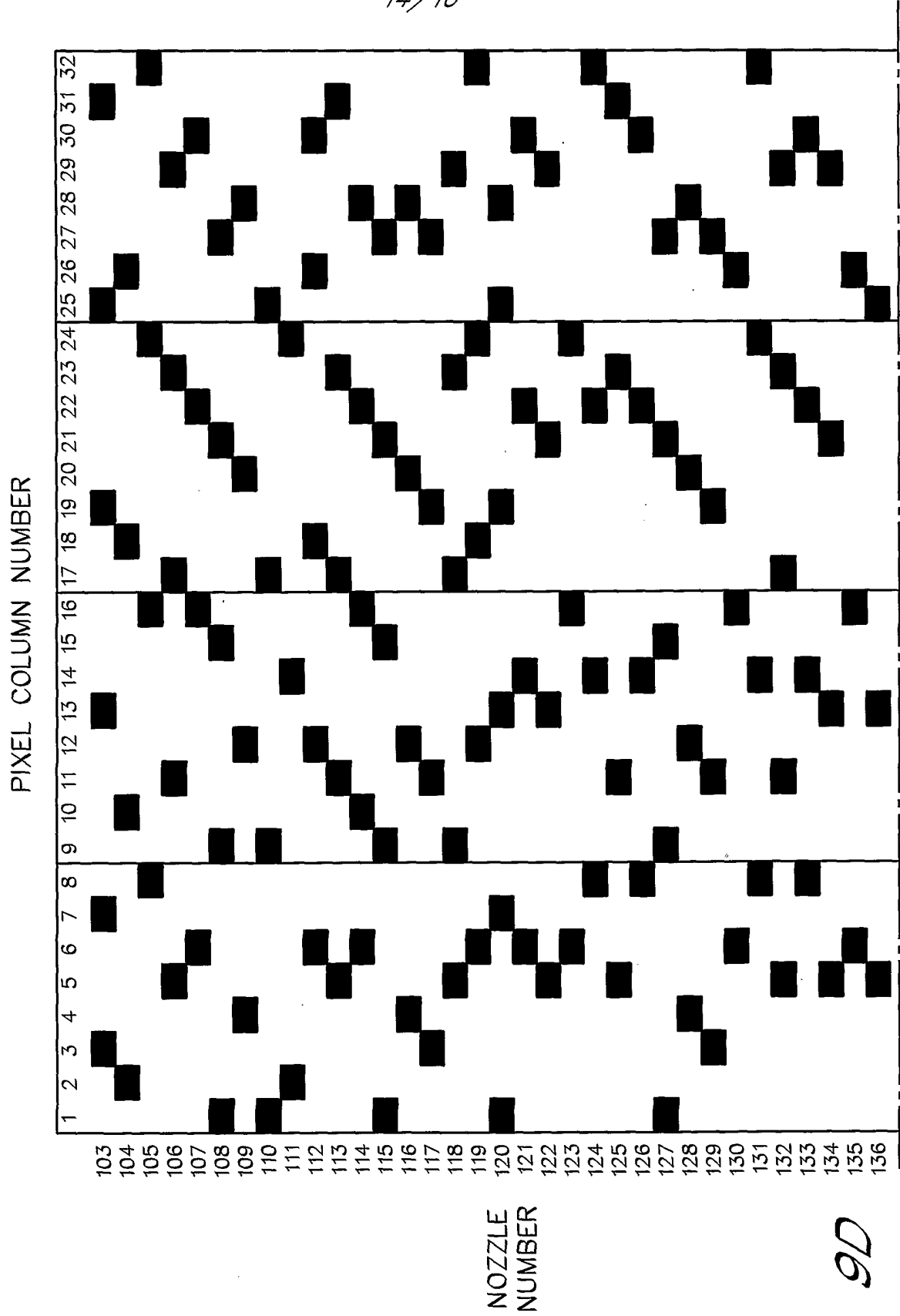

FIG. 9D

15/16

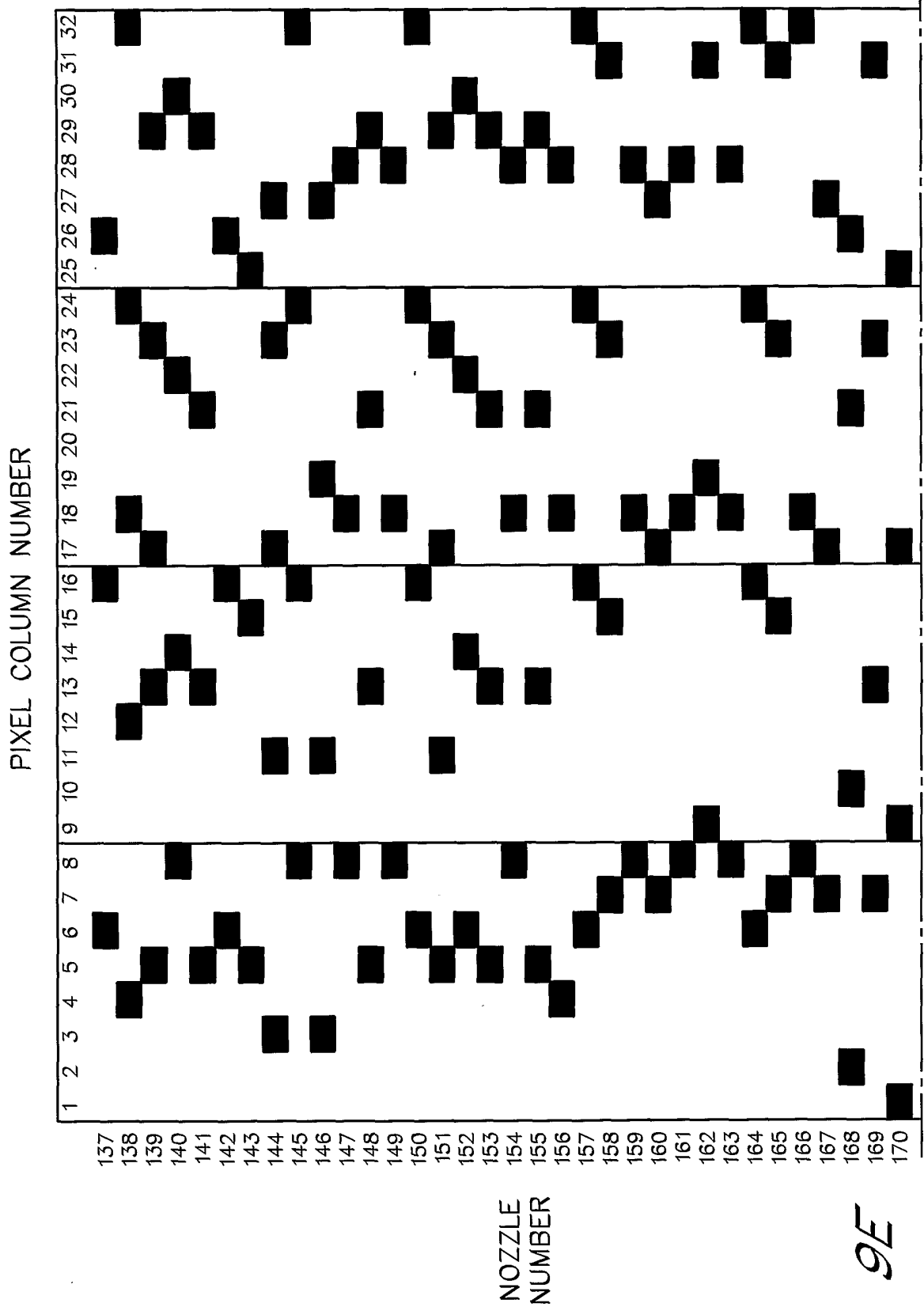

FIG. 9E

16/16

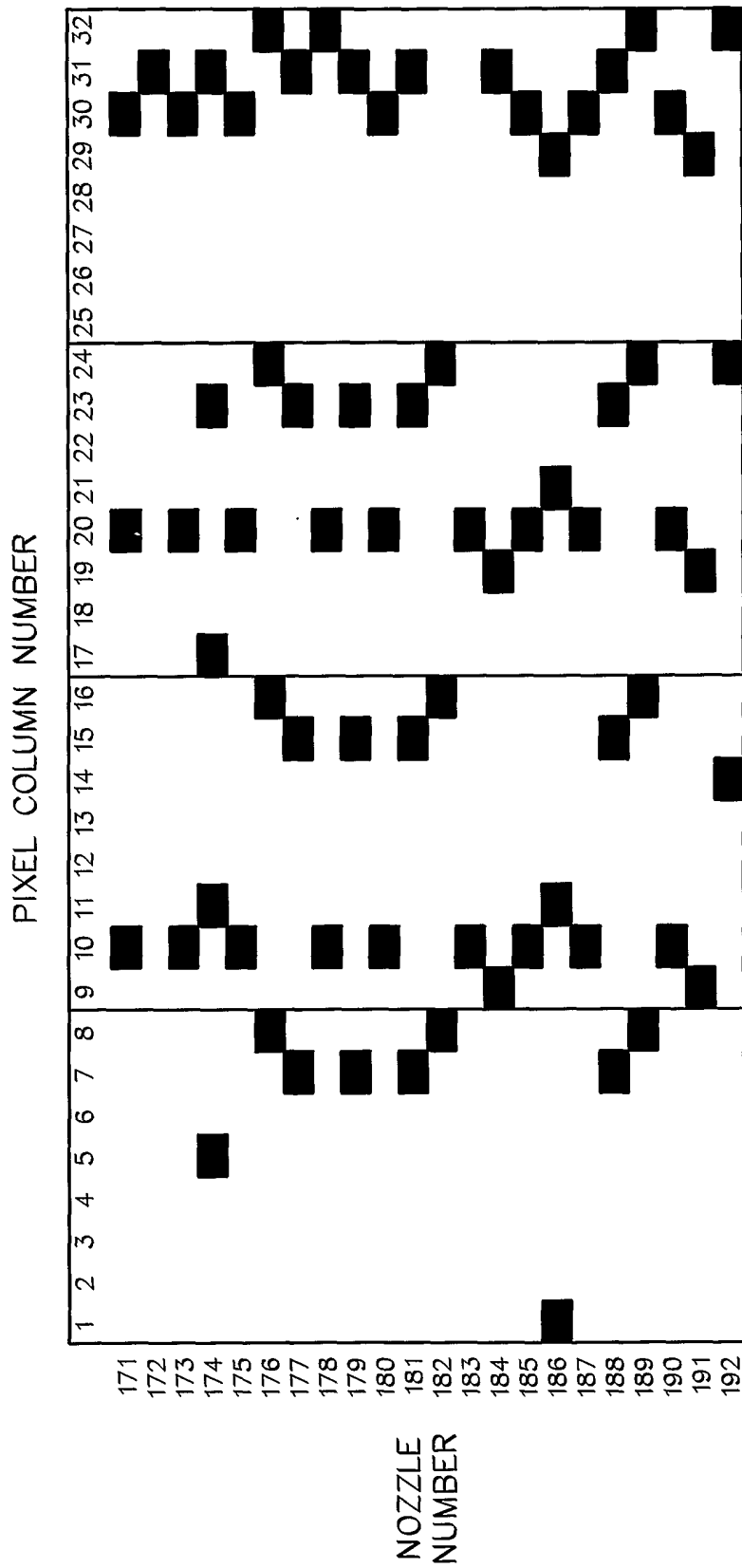

FIG. 9F

INTERNATIONAL SEARCH REPORT

In International Application No
PCT/US 00/33964

A. CLASSIFICATION OF SUBJECT MATTER
IPC 7 G06K15/10 B41J2/21

According to International Patent Classification (IPC) or to both national classification and IPC

B. FIELDS SEARCHED

Minimum documentation searched (classification system followed by classification symbols)
IPC 7 G06K B41J

Documentation searched other than minimum documentation to the extent that such documents are included in the fields searched

Electronic data base consulted during the international search (name of data base and, where practical, search terms used)

EPO-Internal, WPI Data, PAJ

C. DOCUMENTS CONSIDERED TO BE RELEVANT

Category *	Citation of document, with indication, where appropriate, of the relevant passages	Relevant to claim No.
X	EP 0 914 948 A (LEXMARK INT INC) 12 May 1999 (1999-05-12)	1,3-19
A	page 17 -page 24; claims 8,16,19; figures 4,8 page 33-39	2
X	US 5 648 806 A (CHILDERS WINTHROP D ET AL) 15 July 1997 (1997-07-15)	1,3-19
A	column 11, line 11 -column 12, line 30; figures 14,19; table 1	2
X	EP 0 554 907 A (SEIKO EPSON CORP) 11 August 1993 (1993-08-11)	1,3-19
A	column 1, line 25 -column 2, line 33; figures 1,6,9,10	2

Further documents are listed in the continuation of box C.

Patent family members are listed in annex.

* Special categories of cited documents :

- *A* document defining the general state of the art which is not considered to be of particular relevance
- *E* earlier document but published on or after the international filing date
- *L* document which may throw doubts on priority claim(s) or which is cited to establish the publication date of another citation or other special reason (as specified)
- *O* document referring to an oral disclosure, use, exhibition or other means
- *P* document published prior to the international filing date but later than the priority date claimed

- *T* later document published after the international filing date or priority date and not in conflict with the application but cited to understand the principle or theory underlying the invention
- *X* document of particular relevance; the claimed invention cannot be considered novel or cannot be considered to involve an inventive step when the document is taken alone
- *Y* document of particular relevance; the claimed invention cannot be considered to involve an inventive step when the document is combined with one or more other such documents, such combination being obvious to a person skilled in the art.
- *Z* document member of the same patent family

Date of the actual completion of the international search

23 May 2001

Date of mailing of the international search report

31/05/2001

Name and mailing address of the ISA

European Patent Office, P.B. 5818 Patentlaan 2
NL - 2280 HV Rijswijk
Tel. (+31-70) 340-2040, Tx. 31 651 epo nl,
Fax: (+31-70) 340-3016

Authorized officer

Cardigos dos Reis, F

INTERNATIONAL SEARCH REPORT

Information on patent family members

International Application No

PCT/US 00/33964

Patent document cited in search report		Publication date	Patent family member(s)	Publication date
EP 0914948	A	12-05-1999	US 6017112 A	25-01-2000
			JP 11235816 A	31-08-1999
US 5648806	A	15-07-1997	US 5949453 A	07-09-1999
			US 5625396 A	29-04-1997
			US 5278584 A	11-01-1994
			DE 69509853 D	01-07-1999
			DE 69509853 T	30-09-1999
			EP 0707967 A	24-04-1996
			US 6174046 B	16-01-2001
			US 5984464 A	16-11-1999
			CA 2132470 A	30-04-1995
			CN 1113184 A	13-12-1995
			DE 69426519 D	08-02-2001
			DE 69426519 T	17-05-2001
			EP 0654352 A	24-05-1995
			ES 2152970 T	16-02-2001
			JP 7186411 A	25-07-1995
			US 5971524 A	26-10-1999
			US 6033048 A	07-03-2000
			US 5883644 A	16-03-1999
			US 5764254 A	09-06-1998
			US 5975679 A	02-11-1999
			US 6017113 A	25-01-2000
			US 5946012 A	31-08-1999
			US 5635966 A	03-06-1997
			US 5604519 A	18-02-1997
			US 5648804 A	15-07-1997
			US 5638101 A	10-06-1997
			US 5594481 A	14-01-1997
			US 5568171 A	22-10-1996
			US 5648805 A	15-07-1997
			US 5563642 A	08-10-1996
			US 5874974 A	23-02-1999
			US 5619236 A	08-04-1997
			US 6183076 B	06-02-2001
			US 5953029 A	14-09-1999
			CA 2083341 A	03-10-1993
			DE 69305401 D	21-11-1996
			DE 69305401 T	06-03-1997
			EP 0564069 A	06-10-1993
			ES 2093359 T	16-12-1996
			HK 92997 A	01-08-1997
			JP 6008434 A	18-01-1994
			KR 224952 B	15-10-1999
			US 5434607 A	18-07-1995
EP 0554907	A	11-08-1993	JP 6171084 A	21-06-1994
			DE 69312751 D	11-09-1997
			DE 69312751 T	05-03-1998
			HK 1001915 A	17-07-1998
			SG 52525 A	28-09-1998
			US 6048052 A	11-04-2000