

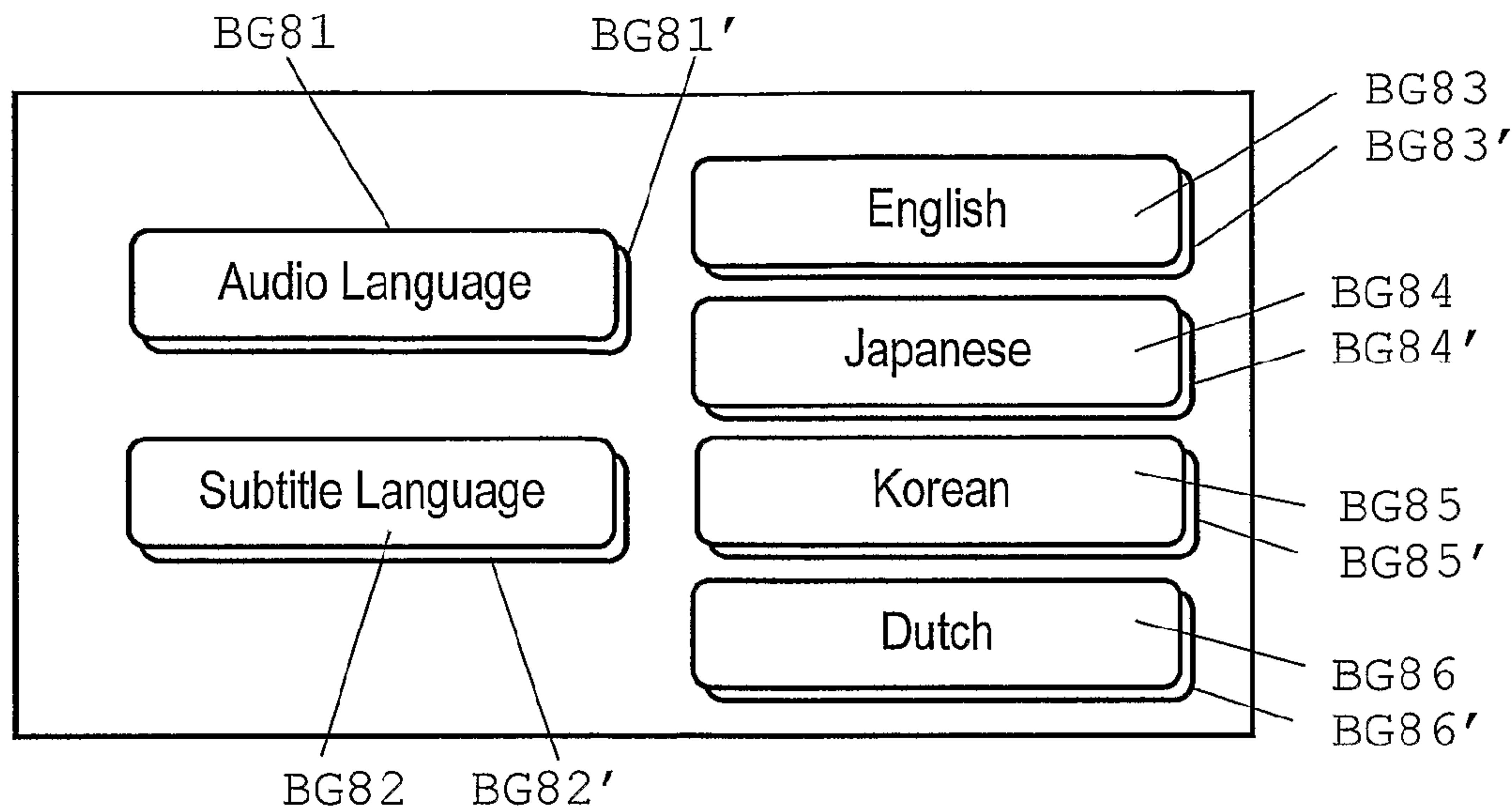

(86) **Date de dépôt PCT/PCT Filing Date:** 2004/12/13  
 (87) **Date publication PCT/PCT Publication Date:** 2005/07/28  
 (45) **Date de délivrance/Issue Date:** 2016/08/09  
 (85) **Entrée phase nationale/National Entry:** 2006/06/14  
 (86) **N° demande PCT/PCT Application No.:** EP 2004/014187  
 (87) **N° publication PCT/PCT Publication No.:** 2005/069109  
 (30) **Priorités/Priorities:** 2004/01/14 (EP04090010.2);  
 2004/02/04 (EP04090035.9)

(51) **Cl.Int./Int.Cl. G06F 3/0482** (2013.01),  
**H04N 5/775** (2006.01)  
 (72) **Inventeurs/Inventors:**  
 HOERENTRUP, JOBST, DE;  
 GANDOLPH, DIRK, DE;  
 HERPEL, CARSTEN, DE;  
 OSTERMANN, RALF, DE;  
 PETERS, HARTMUT, DE  
 (73) **Propriétaire/Owner:**  
 THOMSON LICENSING, FR  
 (74) **Agent:** FETHERSTONHAUGH & CO.

(54) **Titre : PROCEDURE POUR PRODUIRE UN MENU SUR UN ECRAN**  
 (54) **Title: METHOD FOR GENERATING AN ON-SCREEN MENU**



(57) **Abrégé/Abstract:**

A method for generating an on-screen menu comprising menu buttons (BG81, ... ,BG86') and other menu items, e.g. help text, is characterized in that one or more groups of menu buttons or menu items are defined, wherein a group comprises one or more menu buttons or menu items and has associated a defined area on the screen. A state is assigned to a button, the state being "enabled" or "disabled", wherein only an enabled button or item may be displayed, and wherein within a group not more than one button or item may be enabled. The state of a button can be changed by commands associated with other buttons.

29316-42

Abstract

A method for generating an on-screen menu comprising menu buttons (BG81,...,BG86') and other menu items, e.g. help  
5 text, is characterized in that one or more groups of menu buttons or menu items are defined, wherein a group comprises one or more menu buttons or menu items and has associated a defined area on the screen. A state is assigned to a button, the state being "enabled" or  
10 "disabled", wherein only an enabled button or item may be displayed, and wherein within a group not more than one button or item may be enabled. The state of a button can be changed by commands associated with other buttons.

**Method for generating an on-screen menu**Field of the invention

5 This invention relates to a method for generating an on-screen menu.

Background

10 Audio-visual contents of data storage media, e.g. Digital Versatile Discs (DVD) for video applications, usually contain menu data for various applications, e.g. to enable a user to select specific content of the medium. The menu data are used for rendering the menu on a display screen.

15 Often so-called multi-page menus are used, where each possible state of the menu is represented by a full-screen image that is overlaid as a separate layer to the video picture. The menu layer is usually transparent, except for the displayed menu items.

20 In state-of-the-art menus the menu items basically consist of a number of buttons and non-button objects. Each button is assigned an on-screen position by the content author and can be navigated and activated by the user, e.g. via a remote control. Each button is associated a state, which  
25 can either be the 'normal' (or 'unselected') state, the 'selected' state or the 'activated' state. Each button can provide a different visual representation in each state in order to give the user feedback.

30 However, these kinds of menus are rather static as there is no way to dynamically add or remove buttons from the screen, without re-rendering the whole screen. For content

29316-42

2

authors such more sophisticated menu features would be desirable, for example for the design of sub-menus. In such a case, additional buttons dynamically appear and disappear on the screen through user interaction.

5           The invention provides means to generate such dynamic menus.

#### Summary of the Invention

In accordance with one aspect of the present invention, there is provided a method for generating a  
10   displayable menu page from data of a menu data segment, the menu page comprising separately rendered selectable menu buttons, the method comprising: defining at least one group of two or more menu buttons in said menu data segment, wherein a definition of the at least one group of two or more menu  
15   buttons in the menu data segment comprises a parameter indicating the number of menu buttons in the group, and wherein each of the two or more menu buttons has associated a defined area on a display, and each menu button that belongs to the displayable menu page is separately rendered and belongs to not  
20   more than one of said groups; assigning a state to each separately rendered menu button, the state being "enabled" or "disabled", wherein only an enabled menu button is displayed, wherein a menu button in the "enabled" state may have a further state of "normal", "selected" or "activated", and wherein not  
25   more than one menu button within a group may be enabled simultaneously.

In accordance with another aspect of the present invention, there is provided an apparatus for processing a data

29316-42

2a

stream, the data stream comprising menu data for a displayable menu page, wherein the displayable menu page comprises selectable menu buttons to be separately rendered, the apparatus comprising: means for separately rendering each menu button that belongs to the displayable menu page; means for defining, based on data from said data stream, at least one group of menu buttons, the group comprising two or more menu buttons, wherein a menu button may not belong to more than one group, and wherein based on data from said data stream, a parameter indicating the number of menu buttons in the group is defined for the at least one group; means for associating to each of said menu buttons a defined area on a display; means for assigning a state to each of said separately rendered menu buttons belonging to a group, the state being "enabled" or "disabled", wherein only an enabled menu button is displayed, wherein a menu button in the "enabled" state may have a further state of "normal", "selected" or "activated", and wherein not more than one menu button within a group may be enabled simultaneously.

In accordance with another aspect of the present invention, there is provided a computer-readable data storage medium having audiovisual data and computer-executable instructions stored thereon, wherein the computer-executable instructions, when executed on a computer, cause the computer to generate a displayable menu page relating to the audio-visual data, the displayable menu page comprising selectable menu buttons, and the computer-executable instructions further cause the computer to perform a method that comprises: defining at least one group of two or more menu buttons in said computer-readable instructions, wherein a

29316-42

2b

definition of the at least one group of two or more menu buttons in the computer-readable instructions comprises a parameter indicating the number of menu buttons in the group, and each of said two or more menu buttons has associated a defined area on a display, and each menu button that belongs to the displayable menu page is separately rendered and belongs to not more than one of said groups; and assigning a state to each separately rendered menu button, the state being "enabled" or "disabled", wherein only an enabled menu button is displayed and wherein a menu button in the "enabled" state may have a further state of "normal", "selected" or "activated", and wherein not more than one menu button within a group may be enabled simultaneously.

In accordance with another aspect of the present invention, there is provided a method for generating a displayable menu from data of a menu data segment, the menu comprising separately rendered visible and selectable menu items, comprising steps of: determining that at least one group of menu items and at least one further menu item that is outside said group of menu items are defined in said menu data segment, wherein each of the menu items has associated a defined area on the display and an auto\_action\_flag, the auto\_action\_flag indicating whether the menu item automatically switches from the selected state to the activated state, and wherein a menu item may belong to not more than one of said groups, and wherein said further menu item has a command associated that is executed upon activating the further menu item; assigning a state to each menu item of said at least one group of menu items, the state being "enabled" or "disabled", wherein only an enabled menu item may be displayed and may have

29316-42

2c

one of the states unselected, selected or activated, and wherein not more than one menu item within a group may be enabled simultaneously; receiving the command associated to said further menu item when said further menu item is  
5 activated; and upon receiving said command, modifying the "enabled" or "disabled" state of at least one of said menu items that belong to said group.

According to another aspect of the present invention, there is provided apparatus for processing a data stream, the  
10 data stream comprising menu data for a displayable menu, wherein the displayable menu comprises visible and selectable menu items for being rendered separately, the apparatus comprising: means for defining, based on data from said data stream, at least one group of menu items and at least one  
15 further menu item that is outside said group of menu items, wherein a menu item may belong to not more than one of said groups and has an auto\_action\_flag associated, the auto\_action\_flag indicating whether the menu item automatically switches from the selected state to the activated state, and  
20 wherein said further menu item has a command associated that is executed upon activating the further menu item; means for associating to each menu item of said group of menu items a defined area on the display; means for assigning a state to each of said menu items that belong to a group, the state being  
25 "enabled" or "disabled", wherein only an enabled menu item may be displayed and may have one of the states unselected, selected or activated, and wherein not more than one menu item within a group may be enabled simultaneously; and means for receiving said command associated to said further menu item  
30 when said further menu item is activated, and upon receiving

29316-42

2d

said command modifying the "enabled" or "disabled" state of at least one of said menu items that belong to said group.

According to another aspect of the present invention, there is provided a computer-readable storage medium having 5 computer-executable instructions stored thereon that, when executed on a computer, cause the computer to implement the method as described above or below.

According to still another aspect of the present invention, there is provided a method for generating a 10 displayable menu from data of a menu data segment, the menu comprising separately rendered visible and selectable menu items, comprising steps of: determining that at least one group of menu items and at least one further menu item that is outside said group of menu items are defined in said menu data 15 segment, wherein each of the menu items has associated a defined area on the display and for each of the menu items neighborhood information is defined, and wherein a menu item may belong to not more than one of said groups, and wherein said further menu item has a command associated that is 20 executed upon activating the further menu item; assigning a state to each menu item of said at least one group of menu items, the state being "enabled" or "disabled", wherein only an enabled menu item may be displayed and may have one of the states unselected, selected or activated, and wherein not more 25 than one menu item within a group may be enabled simultaneously; receiving the command associated to said further menu item when said further menu item is activated; and upon receiving said command, modifying the "enabled" or "disabled" state of at least one of said menu items that belong 30 to said group.



29316-42

2e

According to yet another aspect of the present invention, there is provided apparatus for processing a data stream, the data stream comprising menu data for a displayable menu, wherein the displayable menu comprises visible and selectable menu items for being rendered separately, the apparatus comprising: means for defining, based on data from said data stream, at least one group of menu items and at least one further menu item that is outside said group of menu items, wherein a menu item may belong to not more than one of said groups and for each of the menu items neighborhood information is defined, and wherein said further menu item has a command associated that is executed upon activating the further menu item; means for associating to each menu item of said group of menu items a defined area on the display; means for assigning a state to each of said menu items that belong to a group, the state being "enabled" or "disabled", wherein only an enabled menu item may be displayed and may have one of the states unselected, selected or activated, and wherein not more than one menu item within a group may be enabled simultaneously; and means for receiving said command associated to said further menu item when said further menu item is activated, and upon receiving said command modifying the "enabled" or "disabled" state of at least one of said menu items that belong to said group.

According to a further aspect of the present invention, there is provided a method for generating a displayable menu from data of a menu data segment, the menu comprising separately rendered visible and selectable menu items, comprising steps of: determining that at least one group of menu items and at least one further menu item that is

29316-42

2f

outside said group of menu items are defined in said menu data segment, wherein each of the menu items has associated a defined area on the display, wherein for each of the menu items the number of commands associated with the menu item is specified, and wherein a menu item may belong to not more than one of said groups, and wherein said further menu item has a command associated that is executed upon activating the further menu item; assigning a state to each menu item of said at least one group of menu items, the state being "enabled" or "disabled", wherein only an enabled menu item may be displayed and may have one of the states unselected, selected or activated, and wherein not more than one menu item within a group may be enabled simultaneously; receiving the command associated to said further menu item when said further menu item is activated; and upon receiving said command, modifying the "enabled" or "disabled" state of at least one of said menu items that belong to said group.

According to yet a further aspect of the present invention, there is provided apparatus for processing a data stream, the data stream comprising menu data for a displayable menu, wherein the displayable menu comprises visible and selectable menu items for being rendered separately, the apparatus comprising: means for defining, based on data from said data stream, at least one group of menu items and at least one further menu item that is outside said group of menu items, wherein for each of the menu items the number of commands associated with the menu item is specified, wherein a menu item may belong to not more than one of said groups, and wherein said further menu item has a command associated that is executed upon activating the further menu item; means for

29316-42

2g

associating to each menu item of said group of menu items a defined area on the display; means for assigning a state to each of said menu items that belong to a group, the state being "enabled" or "disabled", wherein only an enabled menu item may  
5 be displayed and may have one of the states unselected, selected or activated, and wherein not more than one menu item within a group may be enabled simultaneously; and means for receiving said command associated to said further menu item when said further menu item is activated, and upon receiving  
10 said command modifying the "enabled" or "disabled" state of at least one of said menu items that belong to said group.

According to still a further aspect of the present invention, there is provided a method for recording audio-visual data and a menu data structure for generating a  
15 displayable menu relating to the audio-visual data on a removable data storage medium, the menu comprising visible and selectable menu items, wherein all menu items can be separately rendered, the method comprising steps of: creating, in said menu data structure, data for at least one group of menu items  
20 and for at least one further menu item that is outside said group of menu items, each of said menu items having associated a defined area on the display, wherein for each of the menu items the number of commands associated with the menu item is specified, wherein a menu item may belong to not more than one  
25 of said groups, and wherein upon generating a menu from said menu data structure, a state is assigned to each menu item of said at least one group of menu items, the state being "enabled" or "disabled", wherein said "enabled" or "disabled" state is modified upon receiving said command associated to  
30 said further menu item when said further menu item is

29316-42

2h

activated, and wherein only an enabled menu item may be displayed and may have one of the states unselected, selected or activated, and wherein not more than one menu item within a group may be enabled simultaneously; and recording said menu  
5 data structure and the audio-visual data on said removable data storage medium.

Embodiments of the present invention are based on the assumption that the different menu items and buttons of an on-screen menu are rendered separately, not pagewise, on top of a  
10 static or dynamic background that may remain visible.  
"Rendering" means generating values for display pixels.

According to embodiments of the invention, each button is assigned an additional state, which can either be the 'enabled' or the 'disabled' state. As a general rule, this  
15 state defines the rendering behaviour of the button. Buttons that are in the 'enabled' state are typically displayed on the screen, while buttons that are in the 'disabled' state are not rendered and therefore not displayed. Enabled buttons may also be transparent though.

20 The user can navigate only buttons that are in the 'enabled' state, and their well known 'normal', 'selected' or 'activated' state is only valid within the 'enabled' state. The user cannot navigate buttons that are in the 'disabled' state. Any attempt to do that is ignored by the decoder  
25 according to the invention.

29316-42

3

Each button within the menu is assigned an on-screen area and a unique identifier. Usually the on-screen area of buttons will be rectangular, or a combination of rectangular partial areas.

5

According to embodiments of the current invention, buttons are organized in groups, and all buttons obey to certain rules, which are described in the following.

- 10     - The number of buttons belonging to one button group can be one or more. There are no empty button groups.
- A button cannot belong to more than one button group.
- The on-screen area of any button belonging to a first button group does not overlap with the on-screen area  
15     of any other button that is not belonging to the same button group.
- Each button within a button group must be in one of the two states: 'enabled' or 'disabled'.
- Each button is assigned an initial state, which is  
20     either the 'enabled' or the 'disabled' state.
- Not more than one button within a button group can be in the 'enabled' state at a time, i.e. rendered on the screen. Note that the 'enabled' state does not imply user-visibility; e.g. an enabled button is not visible  
25     to the user if it is represented only through transparent pixels.
- For each button within a button group neighbourhood information for button navigation can be defined, saying e.g. which other button to select when the user  
30     presses the LEFT, RIGHT, UP or DOWN button. This neighbourhood information is only valid when the button is in the 'enabled' state. The user cannot navigate to disabled buttons.

- The on-screen areas of a first button of a first button group and a second button of the same group, i.e. their visible representations, may overlap. They will not be visible simultaneously since they belong to the same button group, and only one of them can be in the 'enabled' state at a time.

Further, a new command is defined, based on the invention. This command can e.g. be associated with a button, and it is used to dynamically switch between the 'enabled' and the 'disabled' state of another button. In state-of-the-art menus, activating a button already may encompass the execution of one or more commands. The proposed command is activated in the same way and is therefore compatible with the state-of-the-art framework. Other effects of activating a button are commonly that the button changes its appearance, colour etc.

One aspect of the invention is the definition of a command for enabling or disabling buttons. The information about which button to enable or disable is provided through the button identifier as a parameter of the command.

For each button there can be defined one or more button commands that are executed upon activation of the button. The command or set of commands associated with a button is also referred to as a button handler. The execution of button commands is only possible when the button is in the 'enabled' state. There may be 'empty' buttons however that have no associated button command. The disabling of a button may clear the button visibility by substituting it with transparent pixels.

The inventive button command does usually not change the 'enabled' or 'disabled' state of its own button. This means that if an enabled button is activated, the corresponding button command that is executed upon activation may switch the 'enabled'/'disabled' state of other buttons, but it may not switch its own button to the 'disabled' state, except when its button handler has already scheduled the selection of another button. There may however other commands be executed that comprise e.g. disabling the whole menu.

10 Enabling one button of a group implicitly disables all other buttons within that group.

For each button group a display area is defined where its buttons may be rendered. This area is in the following called a button group area. It is usually rectangular, but can in principle have other shapes. The visible button may have any shape as long as it is within its respective button group area. E.g. it is possible to render a circular button within a rectangular area. The screen pixels that belong to a button group area, but not to an enabled button within said button group area, are rendered transparent.

15  
20

For button group areas according to the invention it is characteristic that no possible button position within a button group may overlap with any possible button position of another button group, so that the button group areas of different button groups may not overlap at all.

25

This means that the screen can be considered as a number of non-overlapping button group areas. When the state of any of the buttons of a button group changes, the decoder according to the invention reads the position of the respective button group area from a storage medium, usually an internal memory, and then re-renders the area. For each

30

group only the enabled button is rendered, wherein the corresponding button group area may comprise any number of transparent pixels.

Advantageously, re-rendering of a button group area never  
5 modifies pixels belonging to any other button group area, since different button group areas may not overlap. This allows easier decoders. Further, it allows easier programming of menus, and particularly easier verification of the respective programming code, e.g. due to static  
10 button positions and static neighborhood relations.

In detail, there are three possibilities for button group areas, as described in the following. They are specialized versions of a general case.

15

The first possibility is the general case as described above, wherein a button group area may comprise several non-overlapping partial areas, and in each button group area a button belonging to the respective button group may  
20 be rendered visible. Therefore a button that belongs to a button group is usually associated with one partial area of its button group area, and then not more than one of the partial areas of a button group may contain an enabled button. In principle it is possible though that an enabled  
25 button is present in more than one of the partial areas of its button group, so that a single button may consist of several equivalent parts. When the state of any of the buttons of a button group changes, the decoder according to the invention reads the positions of the partial areas of  
30 the respective button group from a storage medium and renders all partial areas new. Particularly, it renders not more than one visible button, namely the enabled button.



The second possibility is that a button group area is a contiguous area, e.g. a rectangular area. This means that a cohesive area is defined for each button group, which area comprises all possible positions of buttons belonging to that button group. As mentioned before, the areas that belong to different button groups may not overlap, and the visible button needs not necessarily fill the allowed area, i.e. the button needs not have the size and shape of the button group area, but it must be fully within the area corresponding to its group. Therefore, buttons belonging to different groups may not overlap. Further, it is easy to fully delete a first button belonging to a first button group when displaying a second button belonging to the same button group, because in this case only the button group area belonging to the respective button group needs to be re-rendered, which is a single contiguous area; it is not necessary to re-render other parts of the screen. Thus, no remains of the previously shown button are visible. All buttons within a button group use the same on-screen area. This is the preferred possibility.

The third possibility is that all buttons of a button group have identical areas, i.e. button size and position on the screen. This is the easiest case, with respect to decoder implementation, menu programming and verification, because rendering a button that belongs to a certain button group necessarily deletes another button of the same button group that was previously visible on the same position. Though it provides a less flexible menu than the other two possibilities.

In principle a button group can also contain non-button objects, i.e. menu items that are visible but not

selectable. A non-button object that belongs to a button group has a state assigned, the state being 'enabled' or 'disabled', and can be rendered visible only if it is enabled. Enabling and disabling is done through button handlers associated with menu buttons.

The invention provides more sophisticated menu features, as e.g. demanded by content authors, which features allow easy decoding. In particular, the invention provides means to generate dynamic menus, wherein buttons can be dynamically removed or added to a menu.

With embodiments of the invention, a content author is able to easily define hierarchical menus and sub-menus being represented by a flat data structure. Particularly the programming and verification of menus is easier than with known methods. An advantage of the invention is that the graphics decoder needs not consider the whole menu for any menu operation, but it may simply handle isolated button groups instead. The data that describe the initial menu structure are read from a storage medium, usually a removable storage medium, e.g. optical disc, and are then stored on a temporary storage medium, e.g. memory, which is connected to the decoder. When the menu is operated, the variables within the temporary storage hold the current state.

When a button is invisible, this can either mean that it is disabled and can therefore not be selected or activated, or it is enabled and marked invisible, e.g. has a special flag or only transparent pixels. In the latter case it can be selected, and usually will be automatically activated upon selection, so that associated commands are executed and a visible button is selected. It is also possible to

concatenate invisible buttons, as long as the last button command selects a visible button.

Claim 1 discloses a method for generating a menu using such  
5 button groups. An apparatus that utilizes the inventive method is disclosed in claim 8. A storage medium holding a respective data structure is disclosed in claim 12.

Further objects, features and advantages of the invention  
10 will become apparent from a consideration of the following description and the appended claims when taken in connection with the accompanying drawings.

15 Brief description of the drawings

Exemplary embodiments of the invention are described with reference to the accompanying drawings, which show in

- 20 Fig.1 a menu screen with disabled submenus;  
Fig.2 a menu screen with enabled first submenu;  
Fig.3 a menu screen with enabled second submenu;  
Fig.4 an authoring option for submenu selection;  
Fig.5 a menu screen with selected submenu item;  
25 Fig.6 a button group area according to first possibility;  
Fig.7 a button group area according to second possibility;  
Fig.8 a button group area according to third possibility;  
Fig.9 a screen with menu icon;  
Fig.10 a screen with menu icon and enabled menu;  
30 Fig.11 an initial multi-activation menu screen after first activation of a feature type button;  
Fig.12 a multi-activation menu screen after second activation of a feature type button;

Fig.13 a multi-activation menu screen after third activation of a feature type button;

Fig.14 a menu screen with conditionally enabled item;

Fig.15 initial view of a breadcrumb menu;

5 Fig.16 buttons included in initial view of a breadcrumb menu;

Fig.17 and Fig.18 transition from first to second view in breadcrumb menu;

10 Fig.19 and Fig.20 transition from second to third view in breadcrumb menu; and

Fig.21, 22 and 23 appearances of selected and unselected, but previously selected, buttons in breadcrumb menu, during transition to submenu.

15

#### Detailed description of the invention

Fig.1 shows the initial view of a menu page on a display screen S, with only an "Audio Language" button VB1 and a  
20 "Subtitle Language" button VB2 enabled and visible. The other buttons BG belong to submenus of either of the visible buttons and are invisible, as defined through a data-segment that describes the menu and that is contained in a bitstream on the medium. According to the invention,  
25 these buttons BG belong to separate button groups and are initially disabled, and thus invisible. Moreover, also the two visible buttons VB1,VB2 may belong to separate button groups. The data segment can be called interactive composition segment (ICS). In the initial view shown in  
30 Fig.1 none of the visible buttons VB1,VB2 is activated. Usually one of the visible buttons is initially selected by default. If in the shown case the user presses e.g. the RIGHT button on the remote, nothing would change because

there is no button activated yet. Generally, if neighbourhood relations are defined that lead to disabled buttons, the decoder ignores the relations as long as the neighbour buttons are disabled. Pressing e.g. the UP or  
5 DOWN button would select either of the visible buttons VB1,VB2. Activating the "Audio Language" button VB1 by selecting the button VB1 and pressing on a remote e.g. an "OK" button would lead to a menu display modification, as shown in Fig.2.

10

In Fig.2 the "Audio Language" button VB1 is activated, and the button commands associated with it enable the buttons BGA to the right. Consequently, these buttons BGA are rendered visible, allowing to select and activate one of  
15 them, and thus to select an audio language.

Fig.3 shows a situation where e.g. starting from Fig.2 the "Audio Language" button VB1 was not activated, but the DOWN button was pressed so that the "Subtitle Language" button  
20 VB2 gets selected. Then the "Subtitle Language" button VB2 was activated e.g. by the user pressing an "OK" button on the remote control. The effect is that the four buttons BGS to the right are rendered, presenting subtitle options, and in particular these buttons are rendered in the same  
25 positions as the four buttons BGA to the right were rendered for audio options in Fig.2. This corresponds to the third possibility for positioning buttons of button groups, as described above, since buttons that have the same position but belong to different submenus belong to  
30 the same button group. The buttons BGS shown in Fig.3 are different from the buttons BGA shown in Fig.2, since they have different functions, namely allow selection of a subtitle language. The buttons BGS represent the "Subtitle"

range of buttons for each of the button groups, while the buttons BGA in Fig.2 represent the "Audio" range of buttons of the same button groups. In this particular example, not only the position but also the appearance and the languages of the corresponding buttons of the shown submenus are the same. E.g. in Fig.3, only from the selected button VB2 is visible to which submenu the buttons BGS refer. Therefore, when one of the submenu buttons BGS is selected, the corresponding superior button VB2 should look different from an unselected button, though it is neither selected nor activated.

Fig.4 shows a menu where a graphical user hint GH, in the form of a small arrow, appears in the visible buttons VB1,VB2, showing that related submenus exist. When the "Audio Language" button VB1 is activated or when it is selected and the RIGHT button is pressed on the remote, then its button handler selects an invisible button INB being defined in the neighbourhood information of the "Audio Language" button VB1 as neighbour to the right. The invisible button INB is a so-called auto-action button, since it automatically switches from the selected state to the activated state, so that its button handler is executed. The button handler comprises a command to render the four buttons BGA on the right visible, without any of them being activated, and a command to select the "English" button. The invisible button INB has the same data structure as the other buttons. If the RIGHT button is pressed while the "Audio Language" button is selected, the audio options become visible.

In the next step, one of the new buttons on the right can be selected, as shown in Fig.5. There are four different

button groups BGA, namely 'English', 'Japanese', 'Korean' and 'Dutch'. Further, it is possible that the "Audio language" and the "Subtitle Language" buttons belong to button groups. It is also possible though to combine button groups and single buttons. From the data structure point of view, single buttons may also form a button group with only one element. In the situation depicted in Fig.5, the "Audio Language" button looks selected or activated, and for each of the submenu button groups BGA the buttons representing the options for audio are enabled and visible. They are rendered at the same positions where also the buttons for subtitle options would be rendered, if the "Subtitle Languages" were selected. Therefore the buttons belonging to the same button group are overwriting each other. One of the submenu buttons is selected, and therefore the "Audio Language" button must be deselected, as described later for Fig.23. The selected submenu button can be a default button, e.g. 'English' is a predefined default, or it can be the currently used option, or any other type of default.

20

Fig.6-8 show examples for the three above-mentioned possibilities for defining button group areas. The area of a button group is generally defined through the sum of all on-screen areas of the buttons that belong to that button group. Further, the position of different buttons that belong to the same button group may differ, as long as they are within the area specified for their button group. For practical reasons, i.e. due to the column and row structure of a typical display, the button group area and partial areas will usually be rectangular, though they can in principle have any shape.

30

Fig.6 shows the first possibility for definition of a button group, as described above. A first button group BG61 comprises three buttons B#1,B#4,B#6 with three separate, non-coherent areas. A second button group BG62 also  
5 comprises three buttons B#2,B#3,B#5 with three separate, non-coherent areas. According to the definition of button groups, not more than one button per button group BG61,BG62 is enabled at a time, and may be visible. Thus, only one of the buttons B#1,B#4 and B#6, and only one of the buttons  
10 B#2,B#3,B#5 may be enabled (and visible) at a time, while the others are rendered transparent. Further, none of the individual button areas of the first button group BG61 may overlap with any individual button area from the other button group BG62. It is possible though to surround, even  
15 fully surround, a button group area of a first button group with partial areas belonging to a second button group. In this example, the enabled and visible buttons fully cover their respective button group areas. In another embodiment though it would be possible that areas of buttons that  
20 belong to the same group may overlap, e.g. B#2 and B#5. This is because they may not be visible at the same time, and when one of them is rendered visible, all partial areas of the button group area are re-rendered and thus cleared, i.e. rendered transparent.

25

Fig.7 shows the preferred embodiment, where a single area is defined for every button group, and all buttons belonging to that button group are positioned within that area. A button group BG71 has a defined area where all its  
30 buttons B#11,B#12 are rendered. Another button group BG72 has another area for its buttons B#21,B#22. Also here, button group areas of different button groups may not overlap. The position of different buttons B#11,B#12 that



belong to the same button group BG71 may differ, as long as they are within the specified area.

Fig.8 shows a special case of the preferred embodiment, where all buttons of each button group have exactly the same position, thus overwriting each other. Therefore, the area of a button is identical with the button group area in this case. A first button group comprises an enabled, and therefore visible, "Audio Language" button BG81 and one or more disabled, invisible buttons BG81'. Though the disabled buttons BG81' are drawn visible in the figure for clarity, they have exactly the same display position as the visible button BG81.

Fig.9 shows an example where a menu is represented only through a menu icon MM, while the rest of the screen shows an audio-visual presentation, e.g. a movie. A small icon MM is displayed on the screen, indicating that a menu is available. The icon MM does not disturb the viewer who is watching a movie. When the viewer activates the menu, e.g. through pressing either a dedicated button or the "OK" button on the remote control, further buttons of the menu are revealed, as shown in Fig.10. The user can operate the menu to make selections, e.g. select an audio language or a subtitle language with respective buttons AL,SL. If e.g. the "Audio Language" button AL is selected and activated, an audio language submenu is rendered visible, as shown in Fig.11. It may comprise e.g. the "Audio Language" button AL1, to indicate the current position within the hierarchical menu, and initial language option buttons L1,...,L4 for English, Japanese, Korean and Dutch. The "Audio Language" button AL1 has an indication MI1 for indicating that further options exist. In this example, the further

options can be accessed by repeated activation of the "Audio Language" button AL. This is called multi-activation. If this button AL is activated a second time, audio language buttons L5,...,L8 for Spanish, French, Greek and Polish appear, and after a third activation there are audio language buttons L9,...,L12 for Danish, Norwegian, Finnish and Swedish. After a fourth activation of the "Audio Language" button AL however the initial menu is displayed again, as shown in Fig.10. The menu can be iconified again with the dedicated menu button.

Although the viewer has the impression that only the text within the option buttons changes, it is technically difficult and error-prone to program such a menu with known methods and data structures. In particular, for the verification of the programmed menu data it is necessary to test all possible combinations of buttons, in order to be sure that the menu works correctly. An implementation using button groups according to the invention is advantageous, because the menu needs to be verified with only one button from each button group, and the button group mechanism can be verified separately, only once. Further, it is easy for the menu programmer to rearrange the options, and thus modify the button groups.

25

In the described example, a first button group comprises the buttons for English L1, Spanish L5 and Danish L9. A second button group comprises the buttons for Japanese L2, French L6 and Norwegian L10. A third button group comprises the buttons for Korean L3, Greek L7 and Finnish L11. A fourth button group comprises the buttons for Dutch L4, Polish L8 and Swedish L12.

30

Those buttons of the different button groups that are enabled and visible at the same time can be regarded as a logical layer, though from the data structure point of view they are independent from each other. They are only at the  
5 same time enabled and visible.

But also the "Audio Language" button AL is not a single button, since depending on the current state of the other menu buttons it has different functions. Particularly, the  
10 functions differ in which option buttons must be enabled upon activation of the current "Audio Language" button. E.g. activation of the "Audio Language" button AL1 in Fig.11 causes that the option buttons L5,...,L8 shown in Fig.12 are enabled, while activation of the identical-  
15 looking "Audio Language" button AL2 in Fig.12 causes that the option buttons L9,...,L12 shown in Fig.13 are enabled. Therefore, a fifth button group may comprise the different "Audio Language" buttons AL1,AL2,AL3 that belong to the logical layers. Alternatively, it is possible that the  
20 "Audio Language" buttons AL1,AL2,AL3 are identical, and the button command takes into account which button from the button groups are currently enabled, and the command enables the next element from each button group.

25 Fig.14 shows an example for conditional enabling. Buttons can be enabled or disabled depending on user settings or player settings. E.g. there can be three versions of a movie on a disc: a 'children's cut', a 'theatrical cut' and a 'directors cut'. When the disc is inserted into the  
30 player, the initial menu may show a non-selectable button NSB with e.g. the title of the movie, and three selectable buttons SB1,SB2,SB3 for the reproduction options. A user can however set a parental level, and thus allows the

'children's cut' and the 'theatrical cut', but rejects the 'directors cut'. The screen may then show only two selectable buttons SB1,SB2 for the two allowed options. For the forbidden option however there is no visible button  
5 available, since it is rendered transparent.

According to the invention, this menu behaviour can be technically achieved by using enable/disable commands and button groups. One or more of the option buttons SB1,SB2, SB3 may belong to separate button groups, and according to  
10 specified settings for each button group a defined member is enabled and rendered visibly. In the current example, the "Director's cut" button belongs to a button group SB3 according to the invention, with an associated button group area, and the parental level setting of the player causes  
15 the initial button handler to disable the respective button, i.e. to render the button group area transparent. Also other setting types can be utilized, e.g. reproduction options depending on player type, audio equipment type etc.

20 As a further embodiment of the invention, so-called breadcrumb menus can easily be constructed. Breadcrumb menus are generally menus where the previously pressed button that belongs to another hierarchy remains visible, so that the user can see which button was selected, and to  
25 what the currently displayed option buttons refer. This is particularly useful for hierarchical menus. In the data structure utilized by the invention, hierarchy is given implicitly by neighbourhood relations.

30 Fig.15 shows a menu screen with three buttons AMB,ALMB,SLMB that belong to the same hierarchical level. One of the menu buttons AMB is for multi-angle selection. It is selected, and three angle select option buttons ASB are displayed on

the right. Each of these visible option buttons ASB belongs to a separate button group and was rendered visible because the "Angle" menu button AMB is selected. The other members of these button groups are disabled and thus invisible.

5

Fig.16 shows that the menu comprises also other, invisible buttons IB1,...,IB4. These are used to define what should happen at transitions between the higher level menu buttons AMB,ALMB,SLMB.

10

When the "Angle" menu button AMB is selected, like in Fig.15, and the user wants to select the "Audio Language" menu button ALMB, he presses the DOWN button on his remote, because the "Audio Language" menu button ALMB is displayed

15

below the "Angle" menu button AMB. A dynamic menu, as supported by the invention, may perform the following: First, the button that is defined as DOWN neighbour of the "Angle" button is selected, which is in this example an invisible button IB1. This is the state shown in Fig.17.

20

Although invisible buttons are not represented on the display, they may have a display area or position assigned due to data consistency, e.g. if the same data structure is used for visible and invisible buttons. For illustrative purpose however the figures show also invisible buttons, at

25

their logical positions.

Then, after the invisible button IB1 was selected, it is automatically activated (auto\_action\_flag==true in Tab.1), and its button handler executes the following commands:

30

first it disables the menu option buttons ASB relating to the "Angle" menu button AMB, thus making them invisible, second it enables the option buttons ALSB that belong to the menu button the user wants to select, which is the

"Audio Language" menu button ALMB, and finally it selects the "Audio Language" menu button ALMB, thereby deselecting itself. This is shown in Fig.18. Fig.19 and Fig.20 show the corresponding transition from the "Audio Language" menu  
5 button ALMB to the "Subtitle Language" menu button SLMB using another invisible button IB3, wherein the audio language submenu buttons ALSB are replaced by subtitle language submenu buttons SLSB. Further, there are invisible buttons IB2, IB4 for the opposite transitions.

10

As a result, the menu option buttons ASB, ALSB, SLSB always match the selected menu button AMB, ALMB, SLMB without the selected menu button being activated. The user may not perceive the intermediate states, the invisible buttons or  
15 the short time the described transitions take, usually in the range of milliseconds. According to the invention, the menu option buttons ASB, ALSB, SLSB are implemented as members of button groups. Buttons on the same position that belong to different submenus form a button group. This  
20 allows an easy menu data structure and therefore simplified programming and verification. In particular, button groups may implicitly handle the disabling of obsolete submenu option buttons and the enabling of the correct submenu option buttons that belong to the newly selected menu  
25 button. Since not more than one button from a button group may be enabled, and therefore visible, it is sufficient to select for each button group the new button to be enabled. This implicitly disables the previously enabled button of the group, and the pixels that belong to the button group  
30 area are overwritten according to the bitmap representation of the new button. The rest of the display may remain unchanged. Therefore there is no need for the decoder to analyse which buttons were visible before, which button

must be replaced, which area it occupied and if any button areas overlap.

Another embodiment of the invention, being an exemplary  
5 implementation of the above-described breadcrumb effect, is shown in Fig.21-23. When a hierarchical menu button is selected, e.g. the "Angle" menu button AMB1 in Fig.21, it changes from the normal state to the selected state, and its representation looks different, e.g. highlighted. This  
10 is caused by different bitmap representations corresponding to the states of a button. When the "Angle" menu button AMB1 is activated, it remains only a very short time in the activated state. Its appearance during this time may differ from the selected state, but the user will hardly see it.  
15 When the button is activated, its button handler may select an invisible button INB that is used to render the submenu buttons ASB visible, as described above. This situation is shown in Fig.22. At this time, when the invisible button INB is in the selected state, the "Angle" menu button is  
20 not selected, since only one button of the menu can be selected at a time - otherwise the decoder could not detect to which button a user command refers. The "Angle" menu button is in the normal state instead. But in order to achieve the breadcrumb effect, i.e. indicate the menu  
25 button to which the current submenu buttons ASB refer, it would be desirable to give the menu button AMB1 another appearance. This can be achieved with the button groups according to the invention, e.g. by generating an "Angle" button group.

30

The default "Angle" button AMB1, like any menu button, has the three states normal, selected and activated. Another button, e.g. an "Angle\_Select" button AMB2 belonging to the

same button group looks similar to the default "Angle" button AMB1 and has the same display position, but differs slightly. E.g. its normal state bitmap may be the same as the default buttons selected or activated state bitmap. As  
5 described before, the invisible button INB is automatically activated upon selection. It may e.g. render the submenu buttons ASB visible, then enable the "Angle\_Select" button AMB2 (in the normal state), thus implicitly disabling the previously visible "Angle" button AMB1, and finally select  
10 one of the submenu buttons ASB1, thus deselecting itself. This is shown in Fig.23. The effect is that the user may recognize the button AMB2 as the same button AMB1 like before, and that the button AMB2 looks selected or activated, but actually it is deselected. This allows  
15 giving a button virtually more different representations than states, e.g. colours, shapes, text etc., by replacing it with other buttons. The inventive button groups allow an easy handling of these buttons, and provide a simple mechanism to determine the correct values for pixels within  
20 the button group area.

The group structure provides information for the menu decoder, the information defining which on-screen area needs update. Because within a button group not more than  
25 one button is active at a time, the activation of another button within a group implies the deactivation of the first button of the same group. This is an advantage for authoring, since it makes it easier to author menus.

30 Especially in the case of prerecorded media, e.g. prerecorded Blu-ray discs, a verification process is performed on any title before it is released to check if the data-structure meets the specification. The invention



allows for easy verification while providing enhanced features to the content author when creating dynamic menus.

In the following, the syntax of a data segment shown in Tab.1 is described, which may be contained in a bitstream and describes the initial menu screen, being an exemplary implementation. It describes the case that the button group area is defined according to the second possibility described above.

10

**Tab.1:** Exemplary Syntax of data segment describing a menu

	<b>Syntax</b>	<b>No. of bits</b>	<b>Mnemonics</b>
1	interactive_composition_segment() {		
2	<b>segment_type</b>	8	bslbf
3	<b>segment_length</b>	16	uimsbf
4	<b>composition_number</b>	16	uimsbf
5	<b>composition_state</b>	2	bslbf
6	reserved	6	bslbf
7	<b>command_update_flag</b>	1	bslbf
8	reserved	7	bslbf
9	<b>composition_time_out_pts</b>	33	uimsbf
10	reserved	7	bslbf
11	<b>selection_time_out_pts</b>	33	uimsbf
12	reserved	7	bslbf
13	<b>UO_mask_table()</b>	64	bslbf
14	<b>animation_frame_rate_code</b>	8	uimsbf
15	<b>default_selected_button_number</b>	8	uimsbf
16	<b>default_activated_button_number</b>	8	uimsbf
17	while (processed_length < segment_length) {		
18	button_group() {		
19	<b>button_group_horizontal_position</b>	16	uimsbf
20	<b>button_group_vertical_position</b>	16	uimsbf
21	<b>button_group_horizontal_size</b>	16	uimsbf
22	<b>button_group_vertical_size</b>	16	uimsbf
23	<b>default_enabled_button_number</b>	8	uimsbf
24	<b>num_buttons</b>	8	uimsbf
25	for (i=0; i<num_buttons;i++) {		
26	<b>button_number</b>	8	uimsbf
27	<b>numerically_selectable_flag</b>	1	bslbf
28	reserved	7	bslbf
29	<b>auto_action_flag</b>	1	bslbf

30	reserved	7	bslbf
31	<b>button_horizontal_position</b>	16	uimsbf
32	<b>button_vertical_position</b>	16	uimsbf
33	neighbor_info() {		
34	<b>upper_button_number</b>	8	uimsbf
35	<b>lower_button_number</b>	8	uimsbf
36	<b>left_button_number</b>	8	uimsbf
37	<b>right_button_number</b>	8	uimsbf
38	}		
39	normal_state_info() {		
40	<b>start_object_id_normal</b>	16	bslbf
41	<b>end_object_id_normal</b>	16	bslbf
42	<b>repeat_normal_flag</b>	1	bslbf
43	reserved	7	bslbf
44	}		
45	selected_state_info() {		
46	<b>start_object_id_selected</b>	16	bslbf
47	<b>end_object_id_selected</b>	16	bslbf
48	<b>repeat_selected_flag</b>	1	bslbf
49	reserved	7	bslbf
50	}		
51	actioned_state_info() {		
52	<b>start_object_id_activated</b>	16	bslbf
53	<b>end_object_id_activated</b>	16	bslbf
54	}		
55	<b>num_of_button_commands</b>	8	uimsbf
56	for( cmd_id = 0; cmd_id < num_of_button_commands; cmd_id++ ) {		
57	<b>button_command[cmd_id]</b>	96	bslbf
58	}		
59	}		
60	}		
61	}		
62	}		

**Tab.1 :** Exemplary Syntax of data segment describing a menu

- 5 The notation used in Tab.1 uses while-loops and for-loops. Loops however are only a means to generalize the notation, since the actual bitstream will include data for the single passes or instances of the loop.

Between 1.17 and 1.61 is a loop over the complete data segment of length `segment_length`. A data segment may include any number of button groups.

5 In 1.18 is defined that the following lines, until 1.60, refer to the definition of a button group. The identifier of the group is the value given in round brackets. In 1.19-22 the respective position on the screen is defined for the current button group, also referred to as button  
10 group area in this application. It is defined by its horizontal and vertical size and the position of its reference point. In this case the button group area is only one rectangular, but as described before it may be other areas or a plurality of rectangles. In that case 1.19-22  
15 would be repeated once for each partial area.

The parameter in 1.23 defines which of the buttons of the current group is enabled by default. The decoder uses this value to initially load a register that relates to the  
20 current group and holds a variable. This variable specifies the number of the currently enabled button, and can be modified during operation of the menu. It may also be assigned a value that corresponds to none of the buttons, so that all buttons of the group are disabled. This  
25 mechanism ensures that not more than one button within a group is enabled. Two other parameters that are used to initialize variables that may be modified during menu operation are `default_selected_button_number` (1.15) and `default_activated_button_number` (1.16).

30

In 1.24 the number of buttons in the current group is defined.

The loop beginning in 1.25 covers all buttons of the group and defines for each button a reference number (1.26), if it is numerically selectable (1.27), if it automatically executes its commands when it is selected (1.29), its  
5 position within the button group area (1.31-32), its neighbour buttons (1.33-38), and address ranges indicating where the bitmap representations corresponding to the different buttons states can be read. For every button, one or more commands can be defined. The number of commands of  
10 the current button is specified in 1.55 by the parameter `num_of_button_commands`. The actual commands of the button handler are defined in 1.56-58.

The invention is usable for all kinds of presentation  
15 devices that have access to a display and contain a decoder for processing menu data structures read from e.g. DVDs, Blu-ray discs or other media. Further, the invention is usable for generating such data structures.

20 According to the invention, a decoder for decoding a data stream, the data stream comprising menu data for a visually displayable menu, and the menu comprising separately rendered menu items including selectable menu buttons, includes (i) means for defining at least one group of menu  
25 items, the group comprising one or more menu items, wherein a menu item may not belong to more than one group, (ii) means for associating to said group a defined area on the display, and (iii) means for assigning a state to each of said menu items belonging to a group, the state being  
30 "enabled" or "disabled", wherein only an enabled menu item may be displayed, and wherein not more than one menu item within a group may be enabled simultaneously.

Further, a displayed menu item that belongs to a group is displayed within the area associated with said group, wherein the areas of different groups may not overlap and no display pixel may belong to more than one group.

5

Further, a menu item may have an associated command, which is executed upon activation of the menu item and comprises enabling or disabling of another menu item.

29316-42

28

CLAIMS:

1. A method for generating a displayable menu page from data of a menu data segment, the menu page comprising separately rendered selectable menu buttons, the method  
5 comprising:
- defining at least one group of two or more menu buttons in said menu data segment, wherein a definition of the at least one group of two or more menu buttons in the menu data segment comprises a parameter indicating the number of menu  
10 buttons in the group, and wherein each of the two or more menu buttons has associated a defined area on a display, and each menu button that belongs to the displayable menu page is separately rendered and belongs to not more than one of said groups;
  - 15 - assigning a state to each separately rendered menu button, the state being "enabled" or "disabled", wherein only an enabled menu button is displayed, wherein a menu button in the "enabled" state may have a further state of "normal", "selected" or "activated", and wherein not more than one menu  
20 button within a group may be enabled simultaneously.
2. The method according to claim 1, wherein the areas of menu buttons that belong to different groups do not overlap and no display pixel may belong to more than one group.
3. The method according to claim 1 or 2, wherein the  
25 area associated with a group comprises a plurality of partial areas not connected with each other.

29316-42

29

4. The method according to claim 1, 2 or 3, wherein said group has associated a rectangular area, and wherein visible menu buttons that belong to said group cover only a part of said area, or cover said area completely.

5 5. The method according to claim 4, wherein all visible menu buttons within a group cover the same part of said rectangular area.

6. The method according to any one of claims 1-5, wherein a menu button has an associated command, the command  
10 being executed upon activation of the menu button, and the command comprising enabling or disabling of another menu button.

7. The method according to any one of claims 1-6, wherein the menu relates to audio-visual content of a removable  
15 storage medium, and the menu data are stored on said medium.

8. An apparatus for processing a data stream, the data stream comprising menu data for a displayable menu page, wherein the displayable menu page comprises selectable menu buttons to be separately rendered, the apparatus comprising:

20 - means for separately rendering each menu button that belongs to the displayable menu page;

- means for defining, based on data from said data stream, at least one group of menu buttons, the group comprising two or more menu buttons, wherein a menu button may  
25 not belong to more than one group, and wherein based on data from said data stream, a parameter indicating the number of

29316-42

30

menu buttons in the group is defined for the at least one group;

- means for associating to each of said menu buttons a defined area on a display;

5 - means for assigning a state to each of said separately rendered menu buttons belonging to a group, the state being "enabled" or "disabled", wherein only an enabled menu button is displayed, wherein a menu button in the "enabled" state may have a further state of "normal",  
10 "selected" or "activated", and wherein not more than one menu button within a group may be enabled simultaneously.

9. The apparatus according to claim 8, wherein the areas of menu buttons that belong to different groups do not overlap and no display pixel may belong to more than one group.

15 10. The apparatus according to claim 8 or 9, wherein a menu button has an associated command, the command being executed upon activation of the menu button, and the command comprising enabling or disabling of another menu button.

20 11. The apparatus according to claim 8, 9 or 10, wherein the menu relates to an audio-visual multimedia presentation being stored on a removable storage medium, and wherein the data stream is also stored on said medium.

25 12. A computer-readable data storage medium having audiovisual data and computer-executable instructions stored thereon, wherein the computer-executable instructions, when executed on a computer, cause the computer to generate a displayable menu page relating to the audio-visual data, the



• 29316-42

31

displayable menu page comprising selectable menu buttons, and the computer-executable instructions further cause the computer to perform a method that comprises:

- defining at least one group of two or more menu  
5 buttons in said computer-readable instructions, wherein a definition of the at least one group of two or more menu buttons in the computer-readable instructions comprises a parameter indicating the number of menu buttons in the group, and each of said two or more menu buttons has associated a  
10 defined area on a display, and each menu button that belongs to the displayable menu page is separately rendered and belongs to not more than one of said groups; and

- assigning a state to each separately rendered menu  
button, the state being "enabled" or "disabled", wherein only  
15 an enabled menu button is displayed and wherein a menu button in the "enabled" state may have a further state of "normal", "selected" or "activated", and wherein not more than one menu button within a group may be enabled simultaneously.

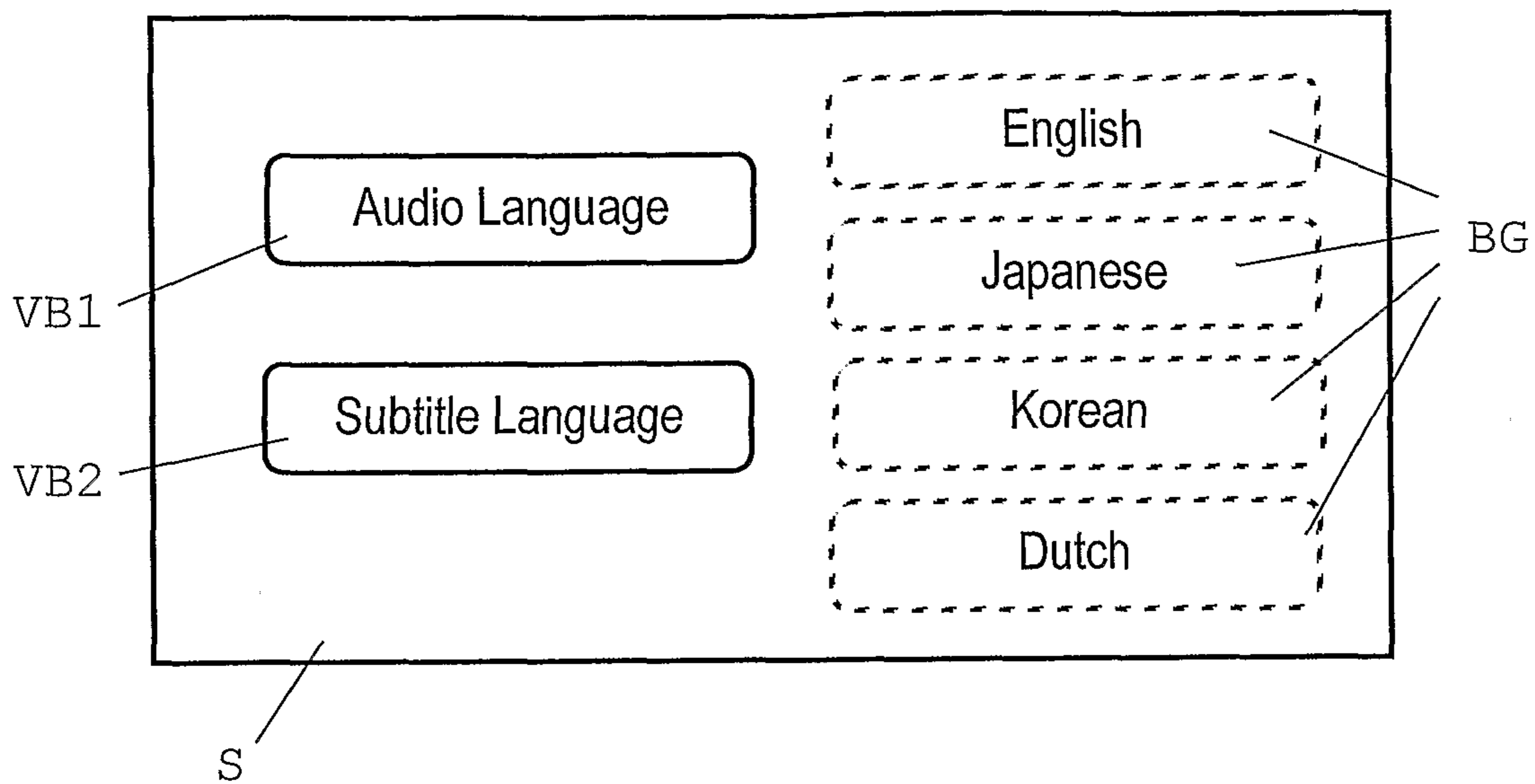

Fig. 1

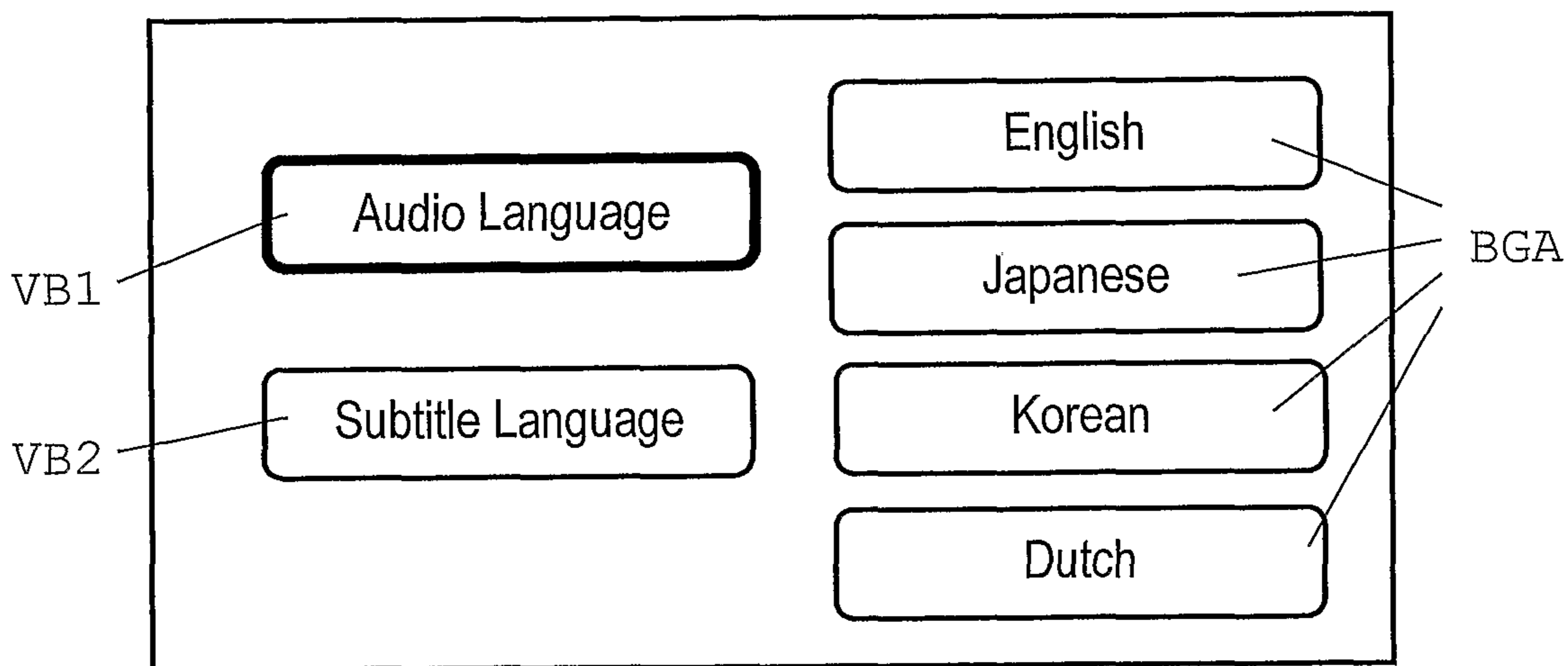

Fig. 2

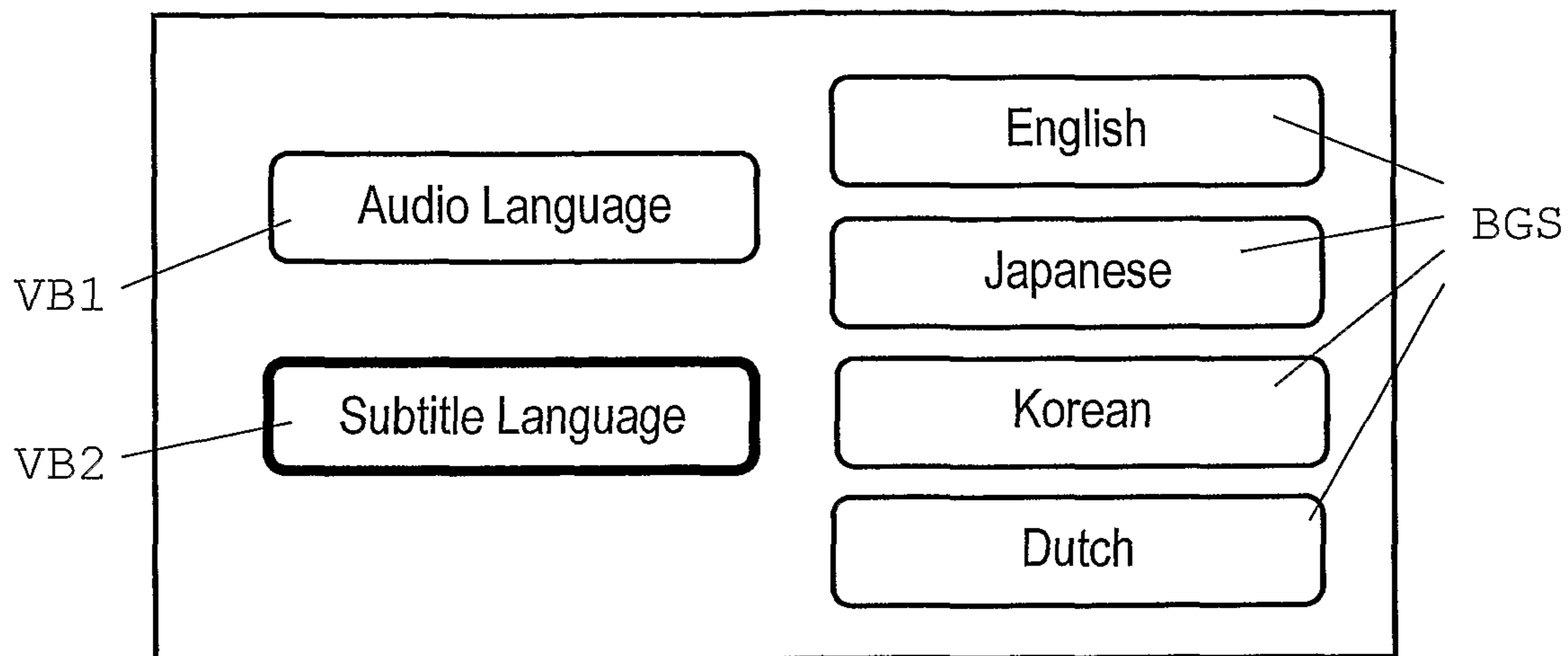

Fig. 3

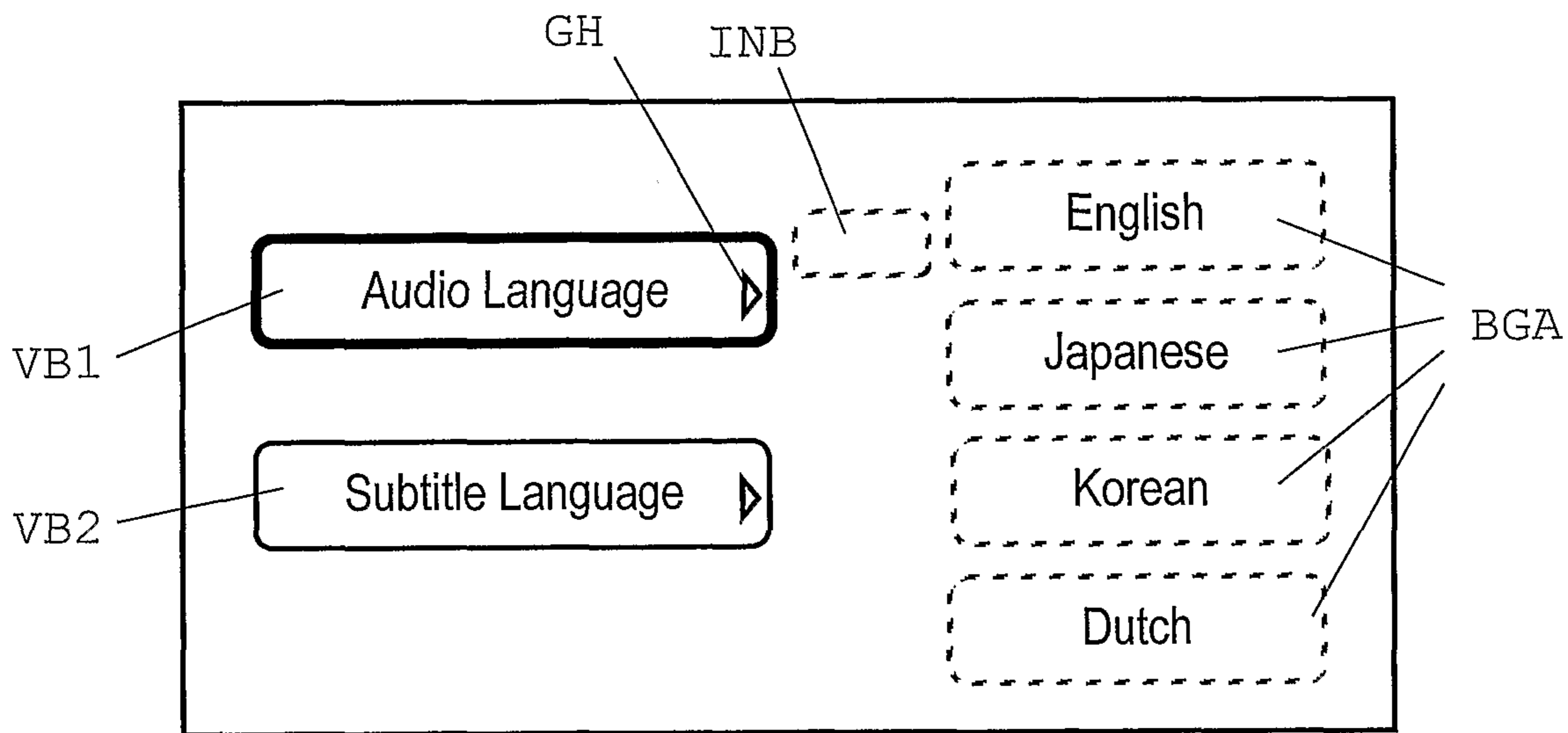

Fig. 4

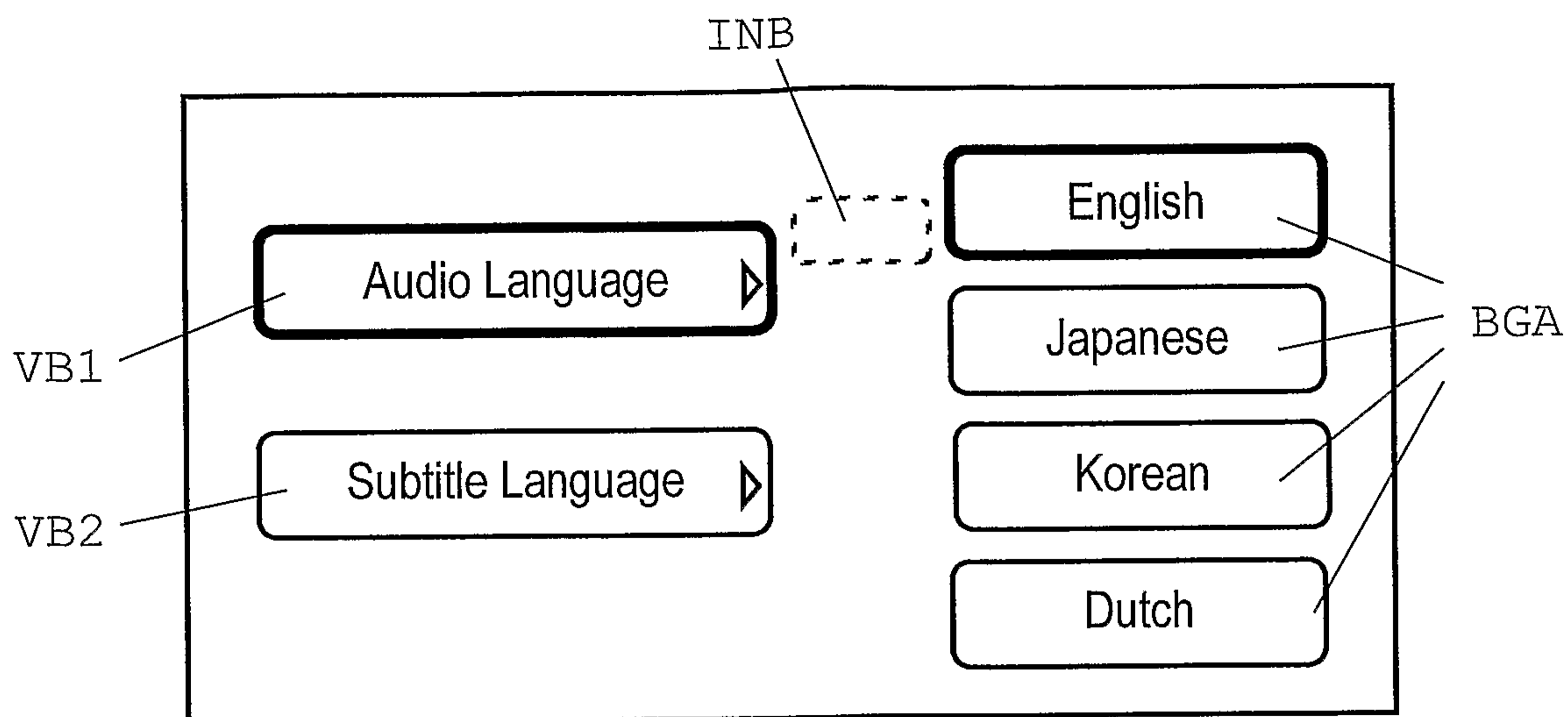

Fig. 5

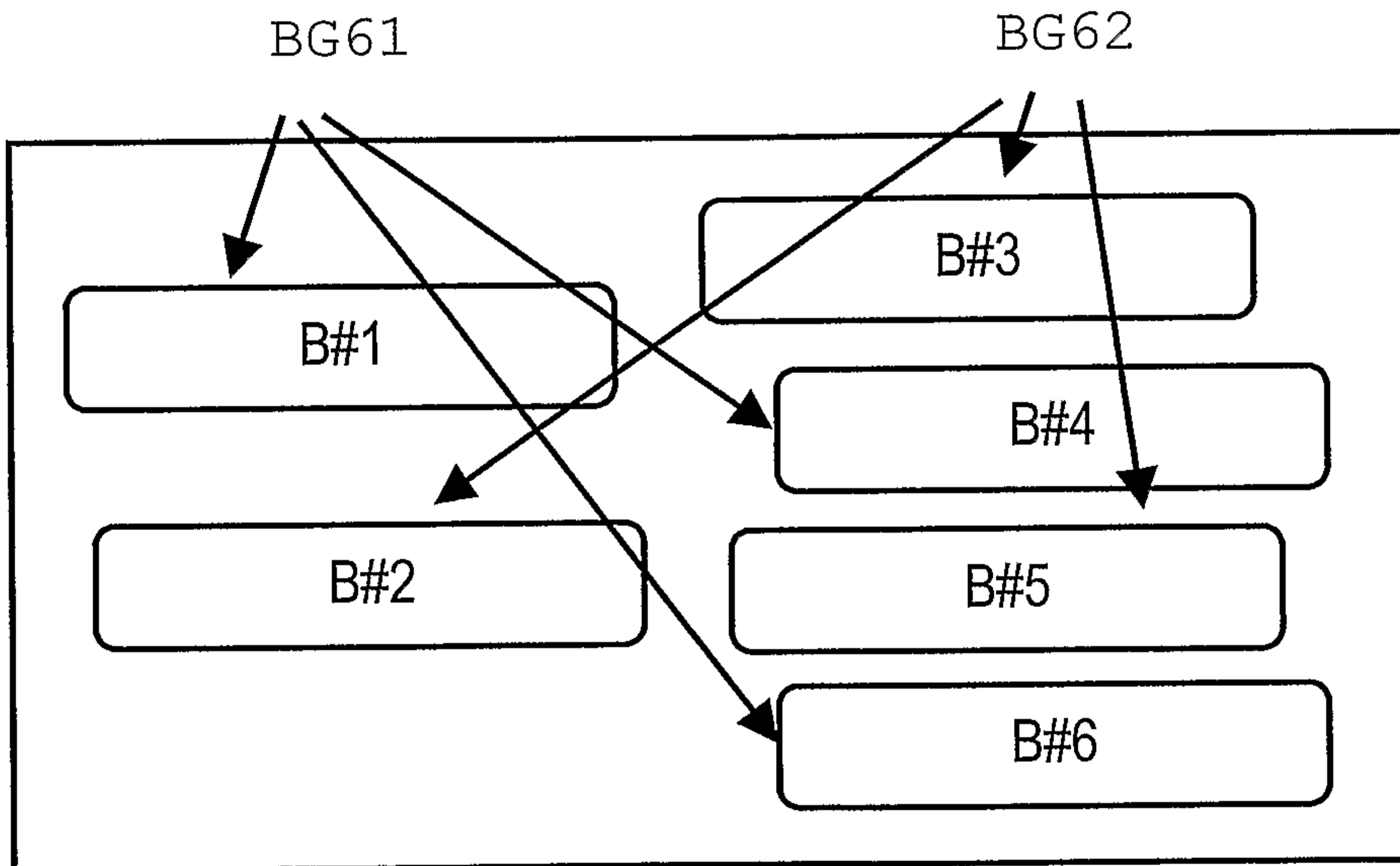

Fig. 6

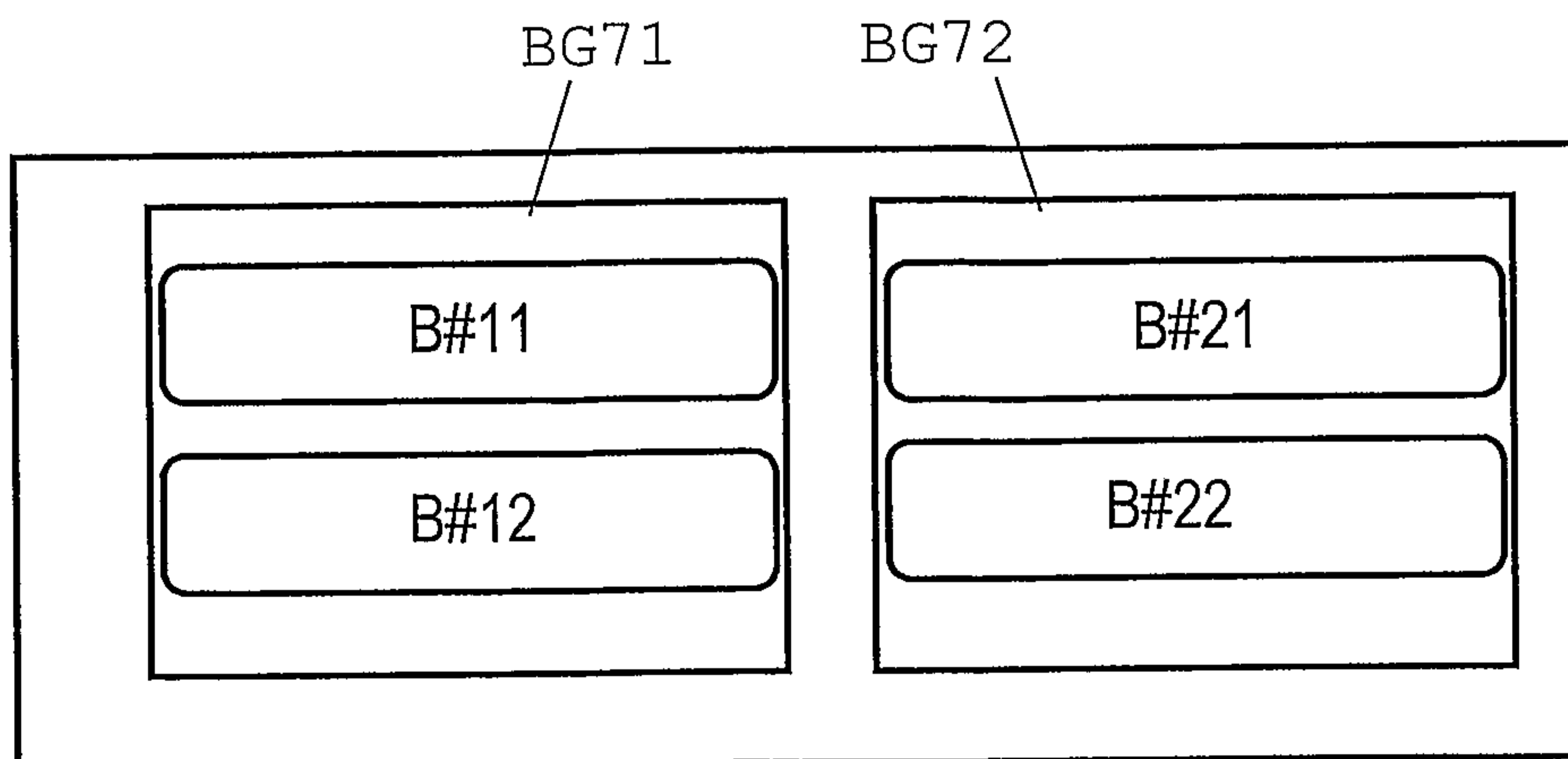

Fig. 7

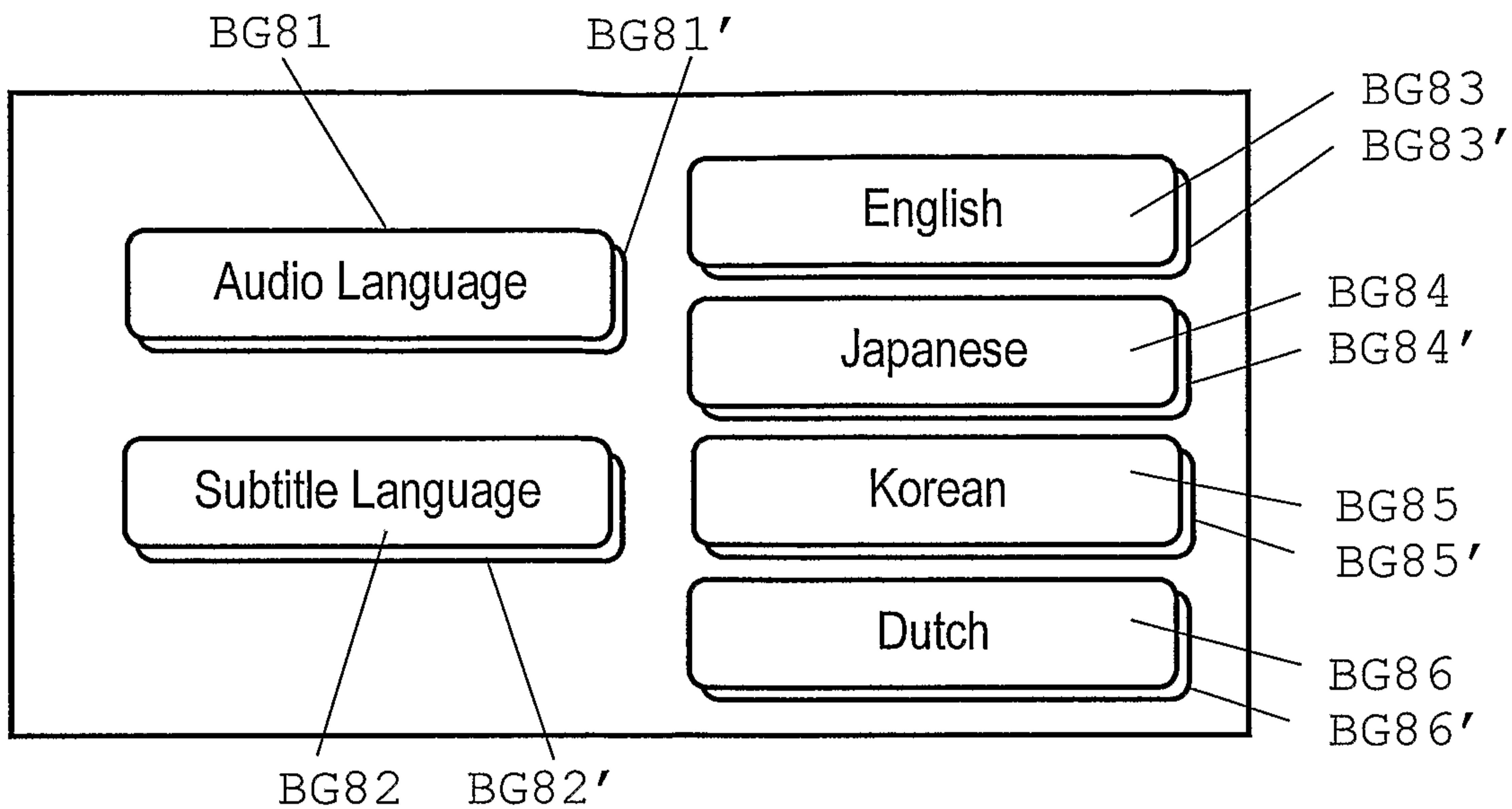

Fig. 8

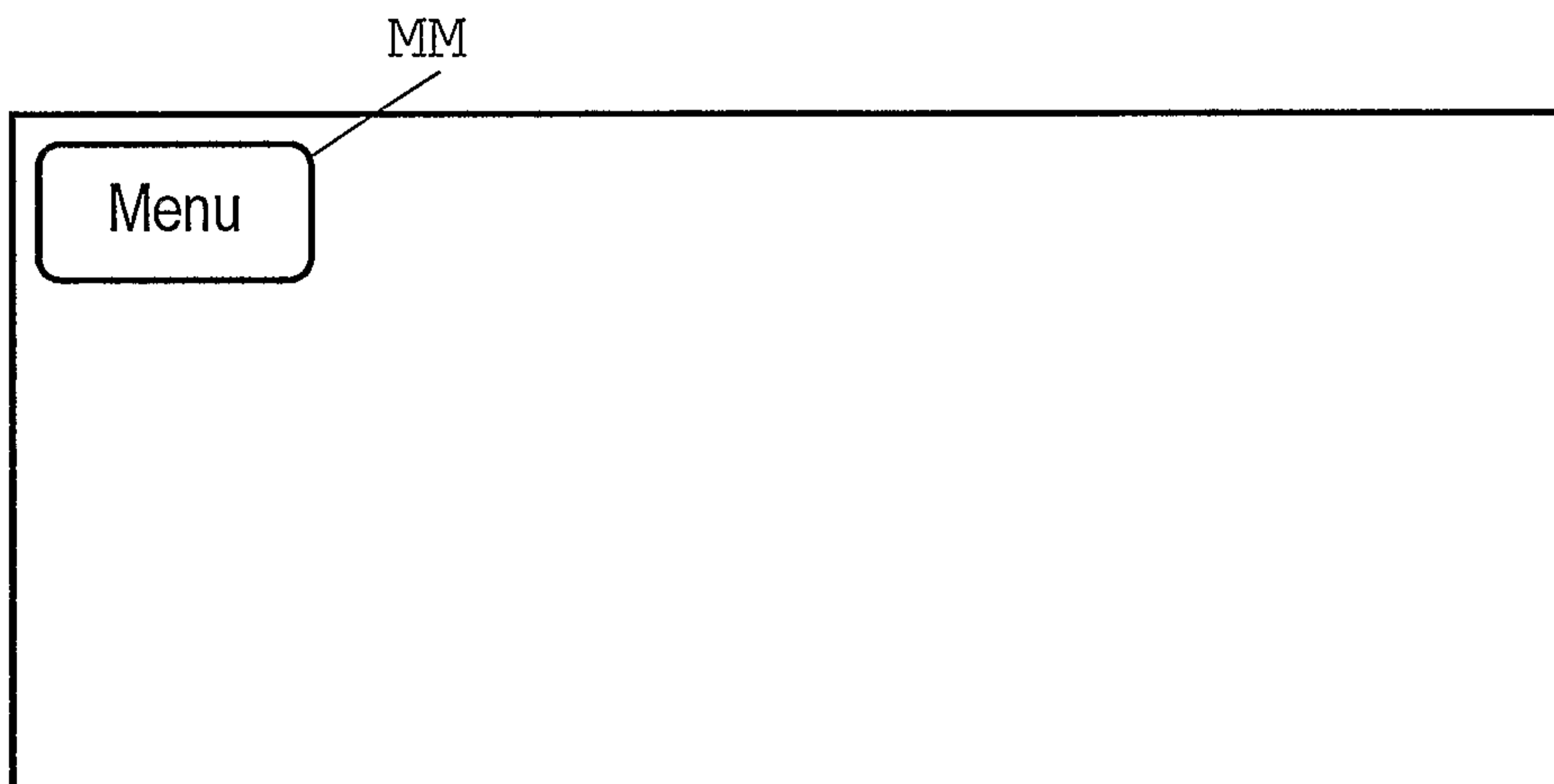

Fig. 9

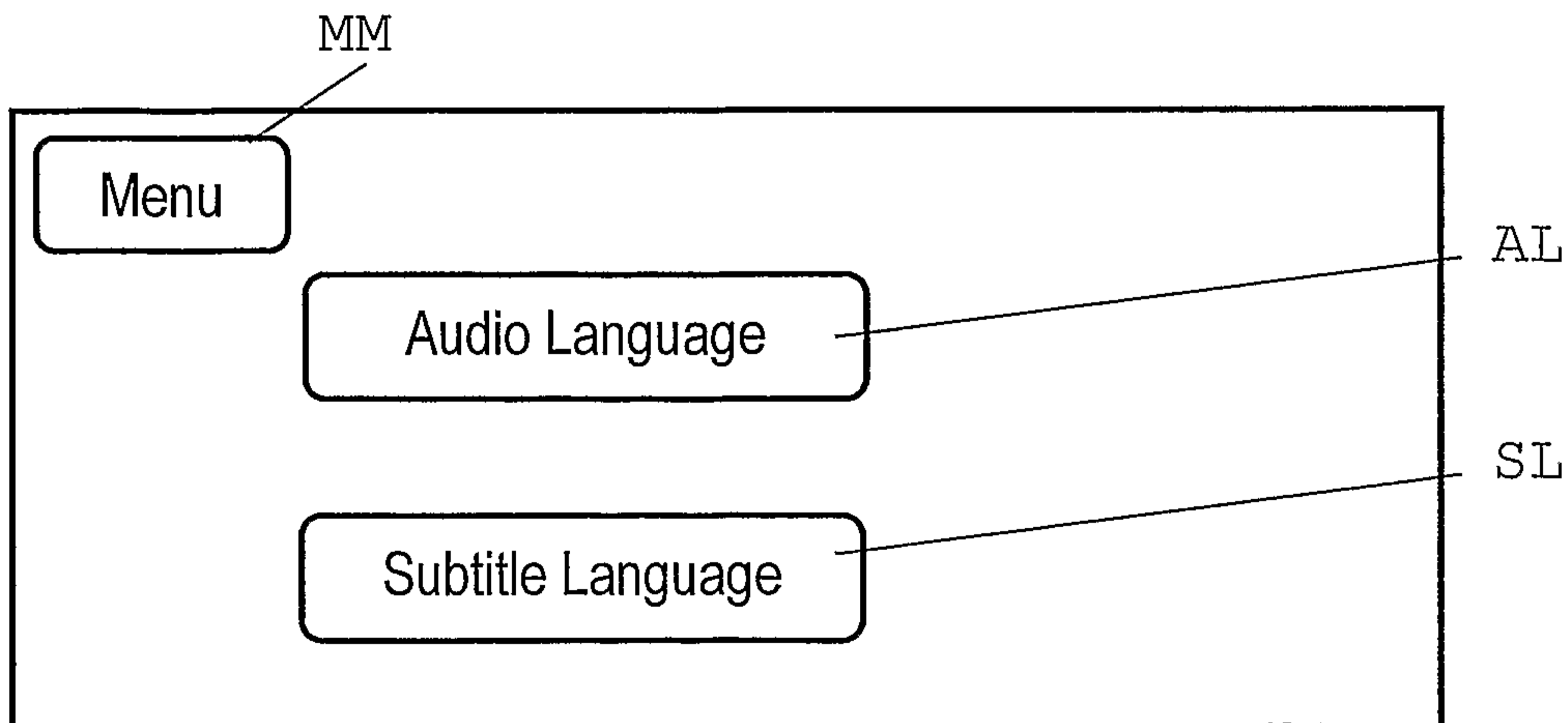

Fig. 10

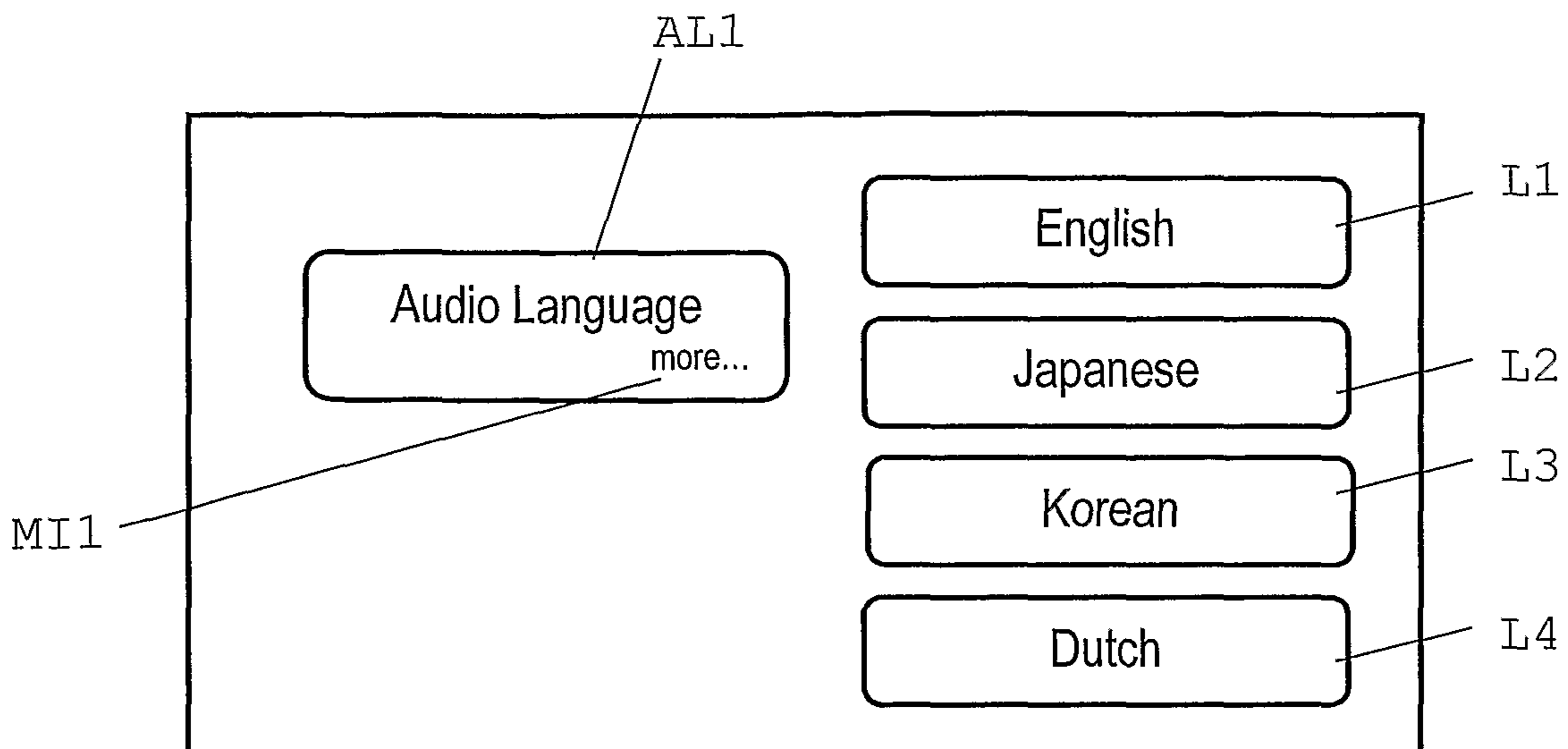

Fig. 11

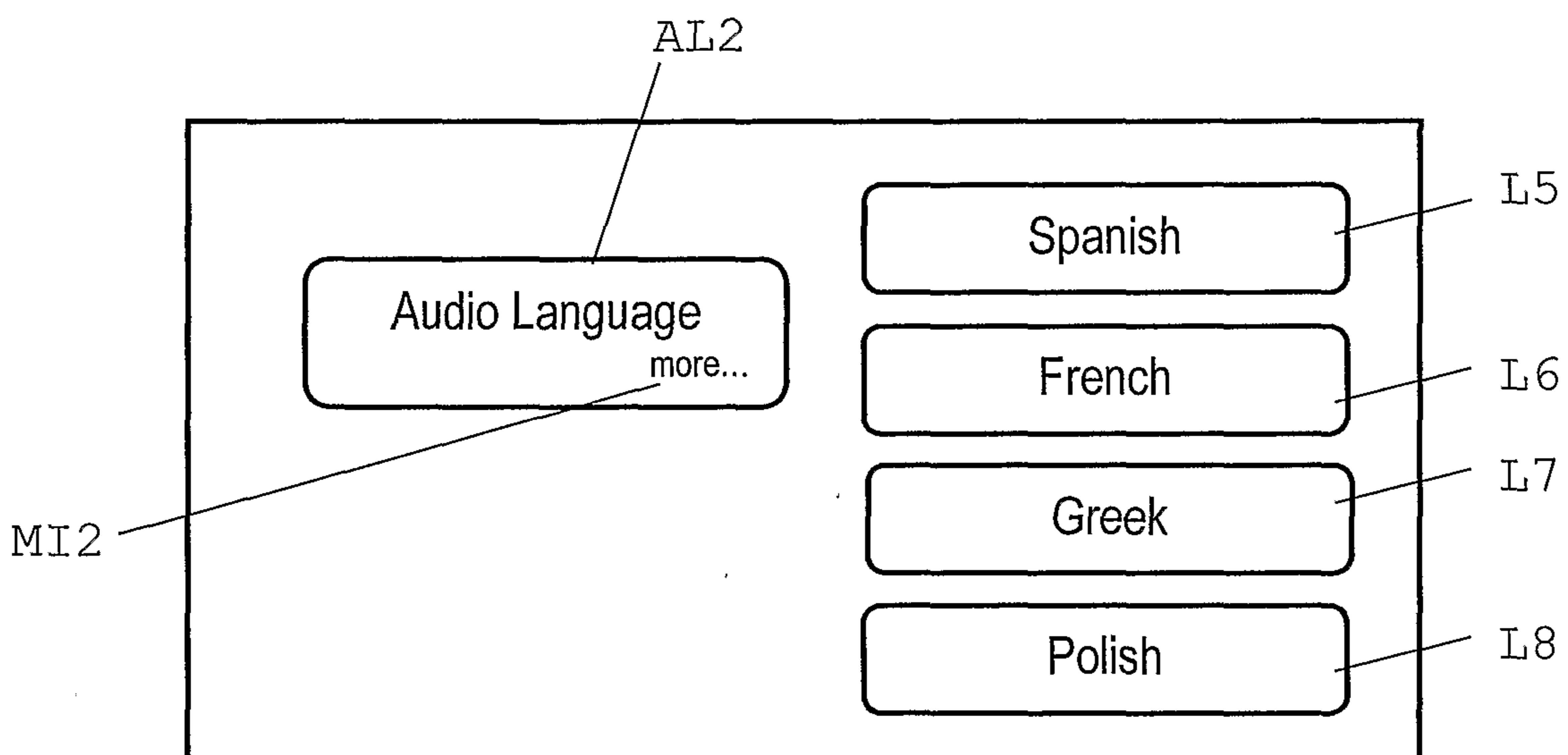

Fig. 12

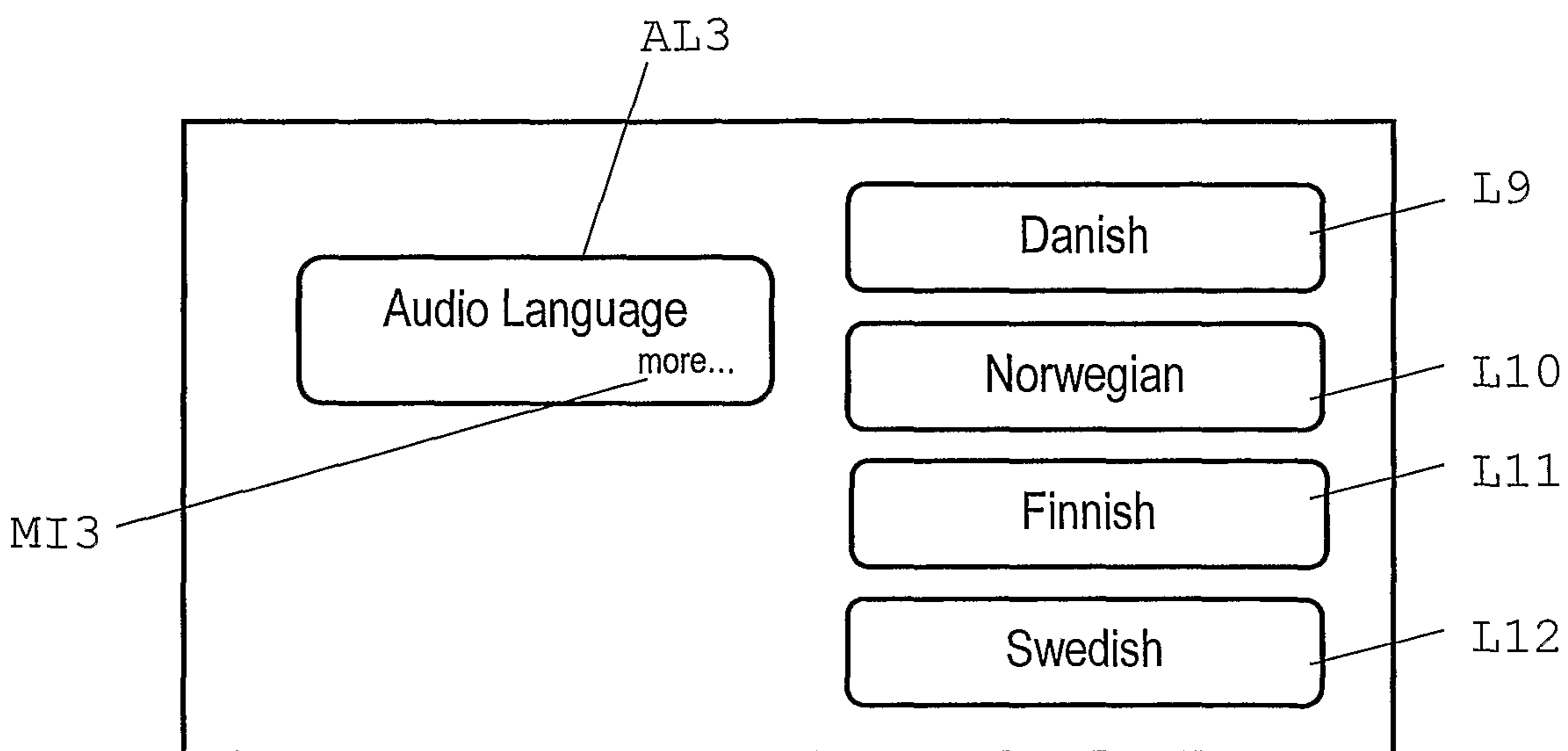

Fig. 13

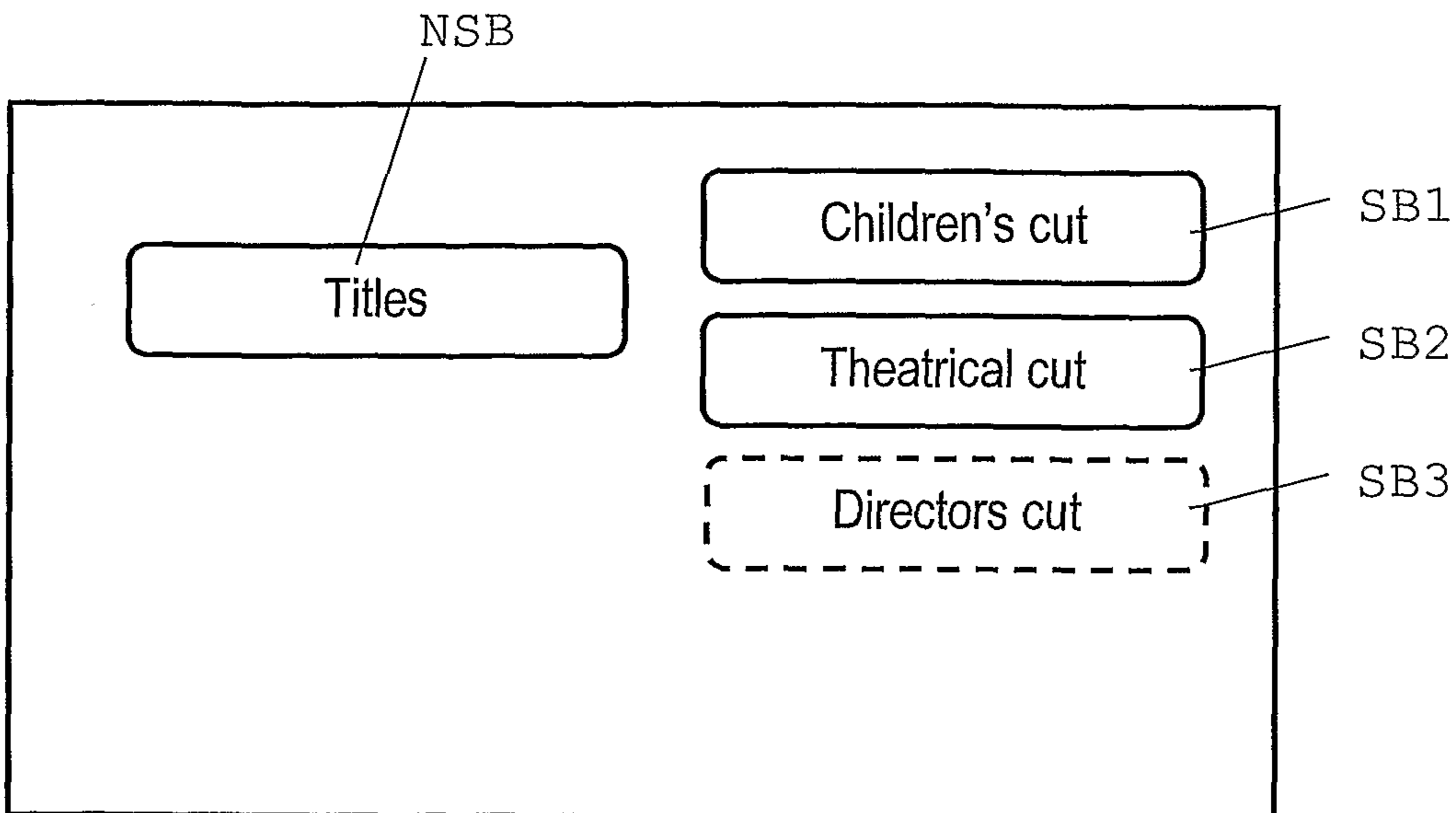

Fig.14

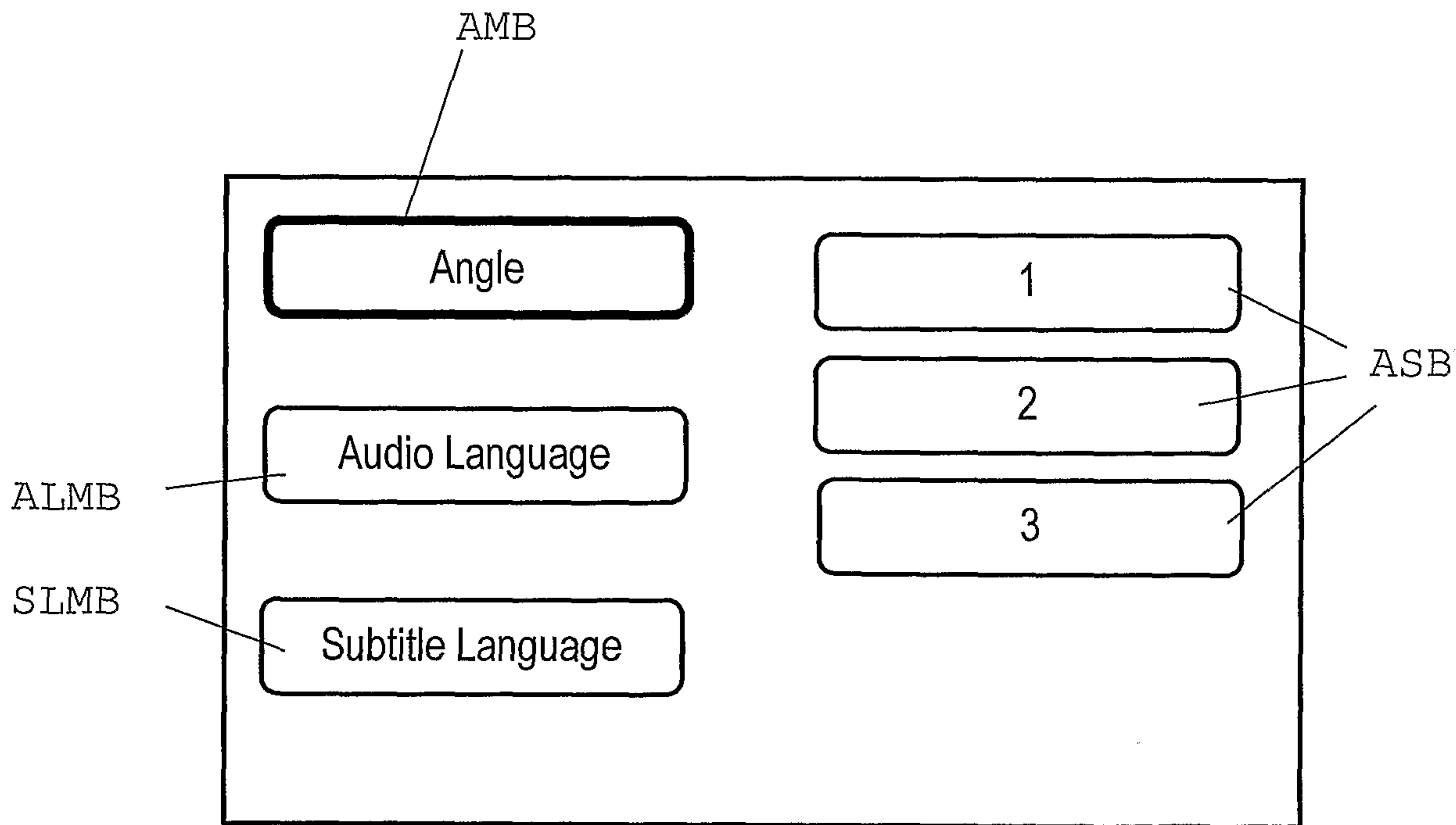

Fig.15

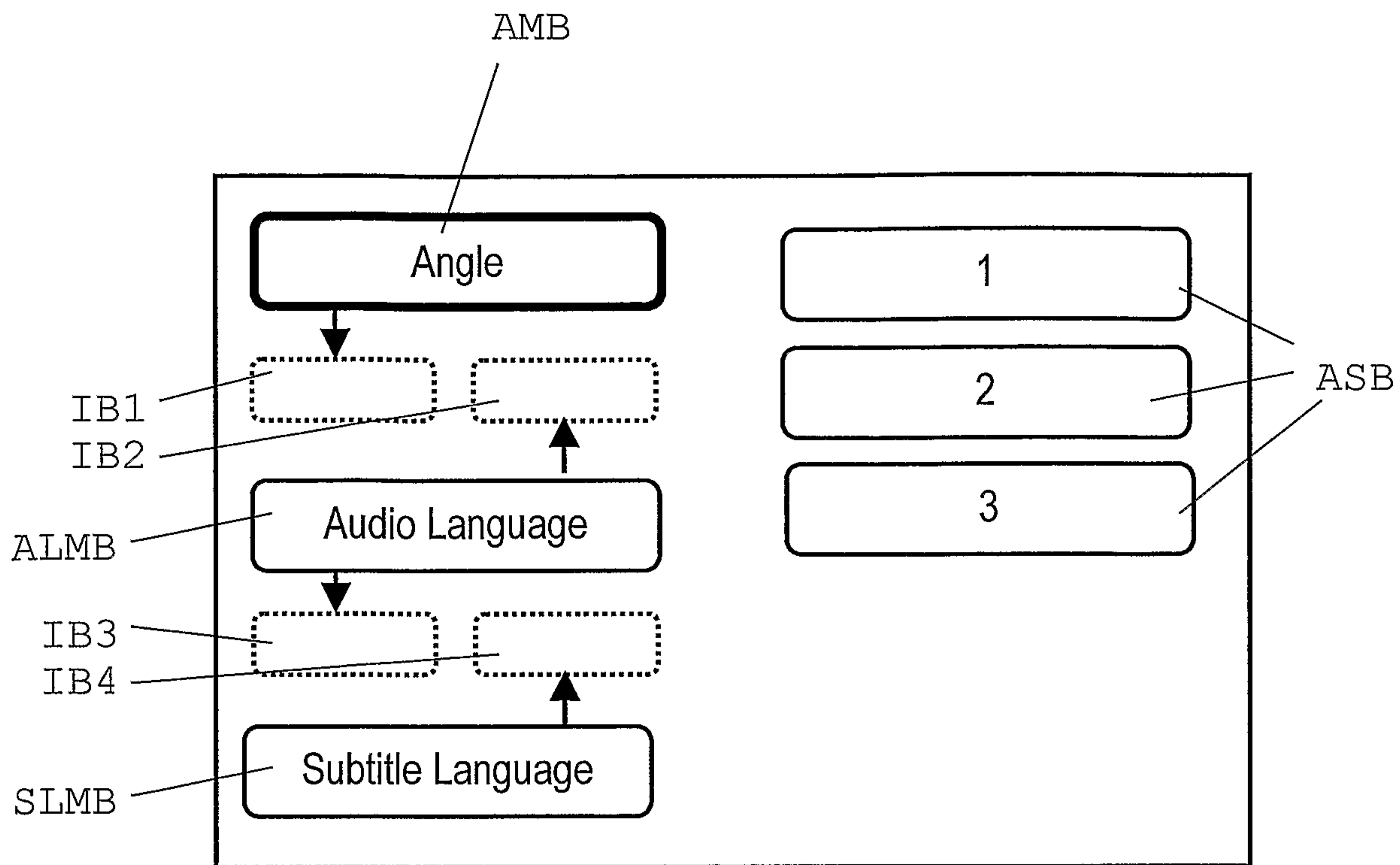

Fig. 16

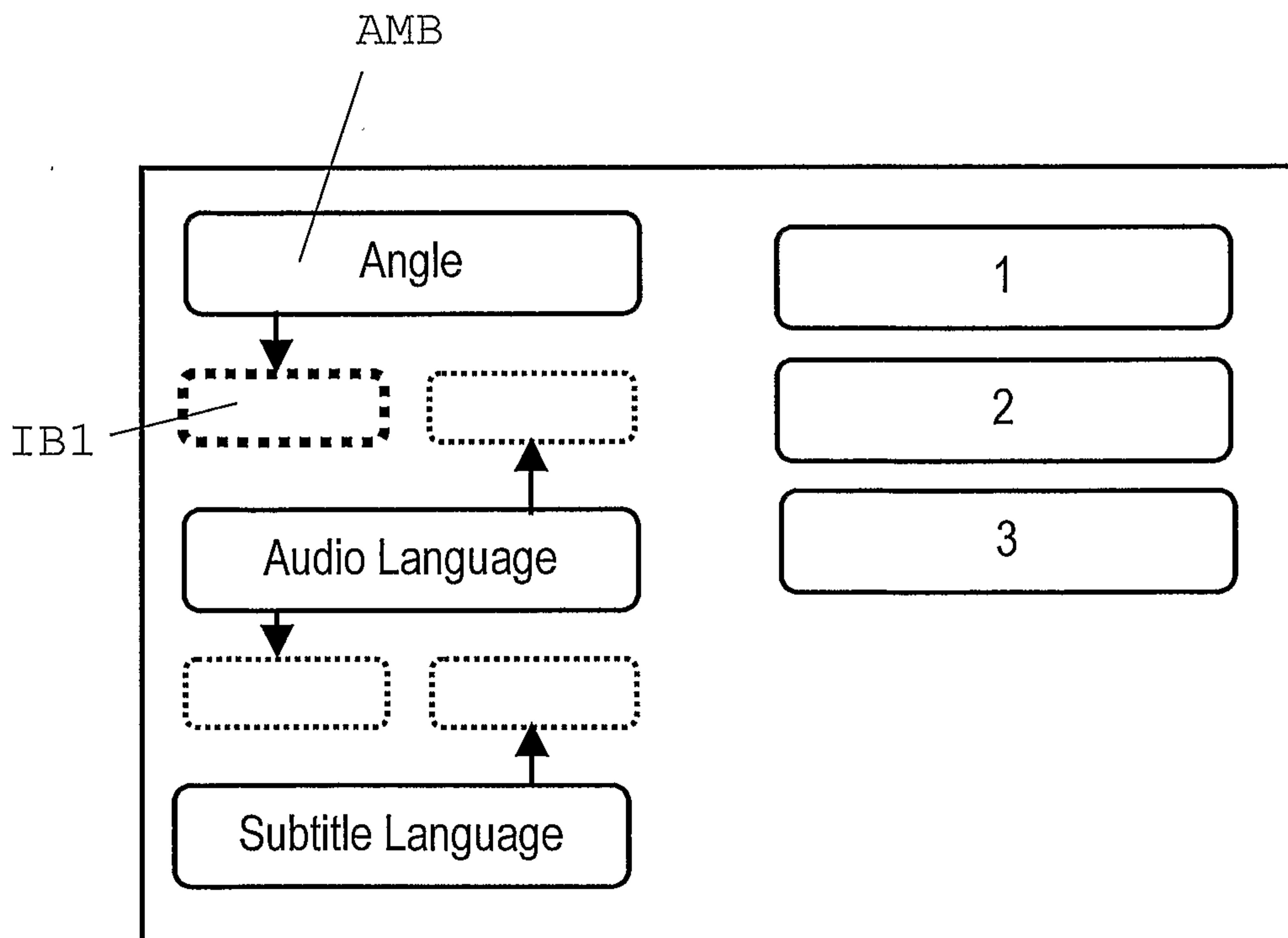

Fig. 17



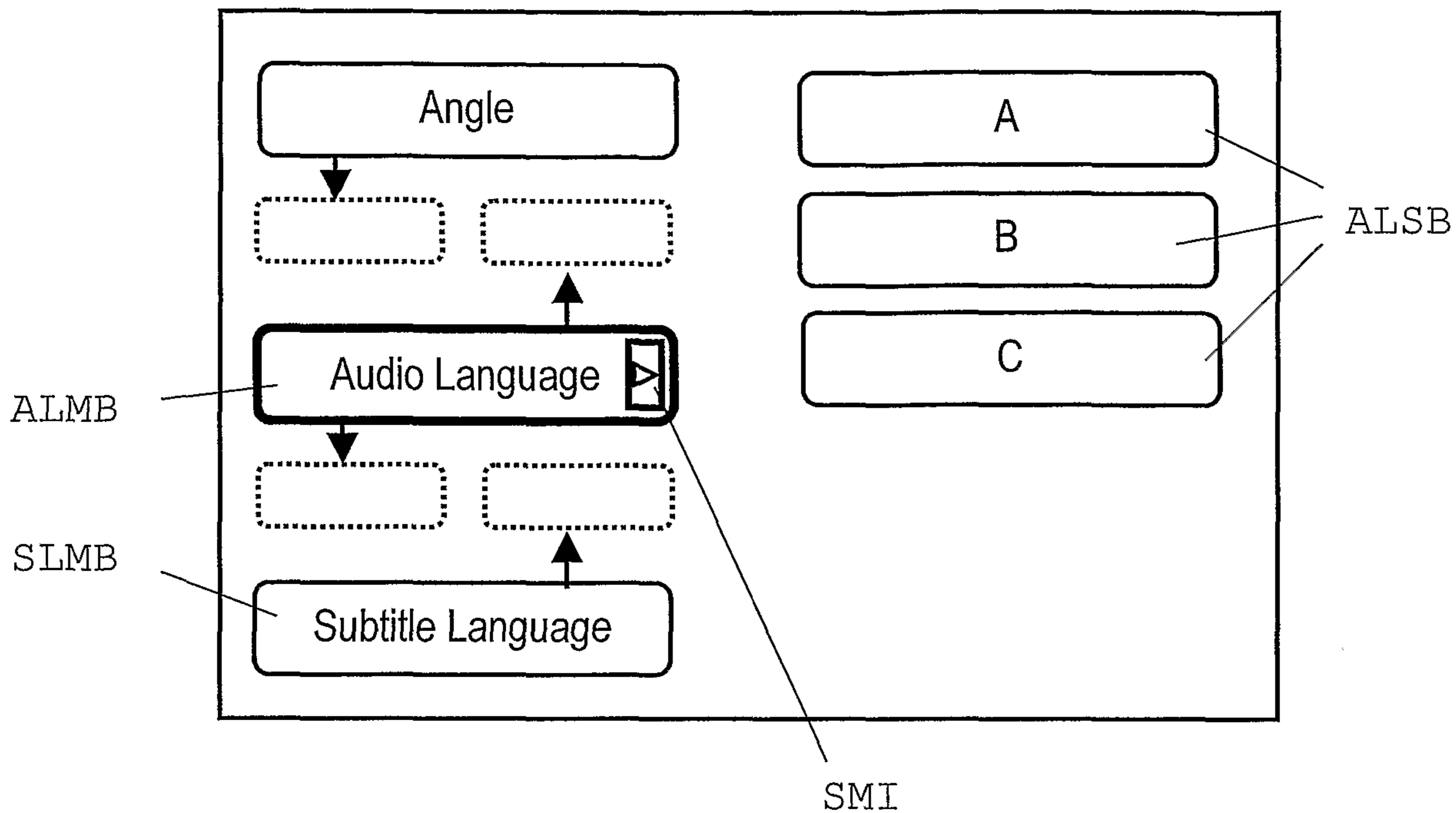

Fig.18

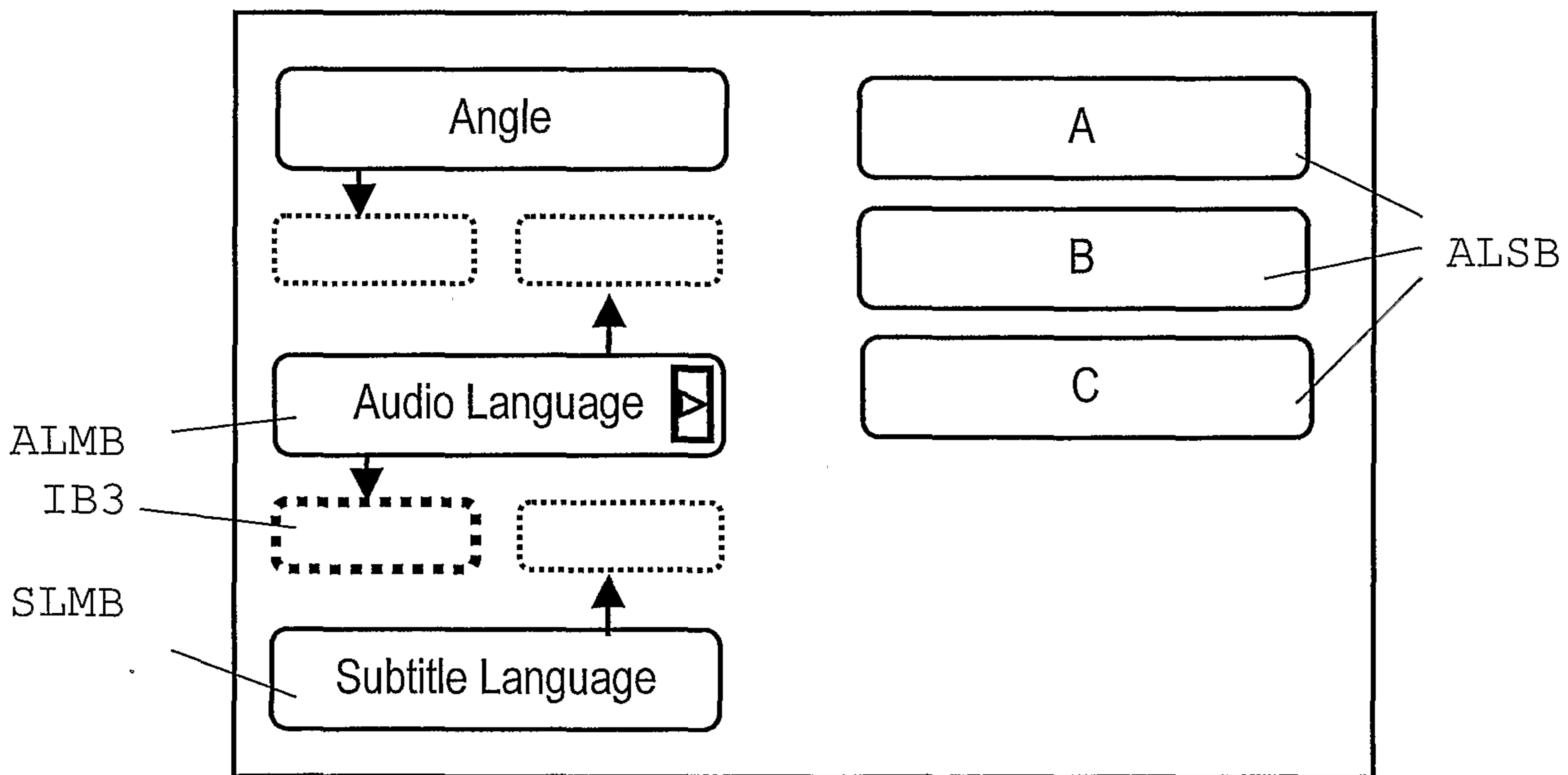

Fig.19

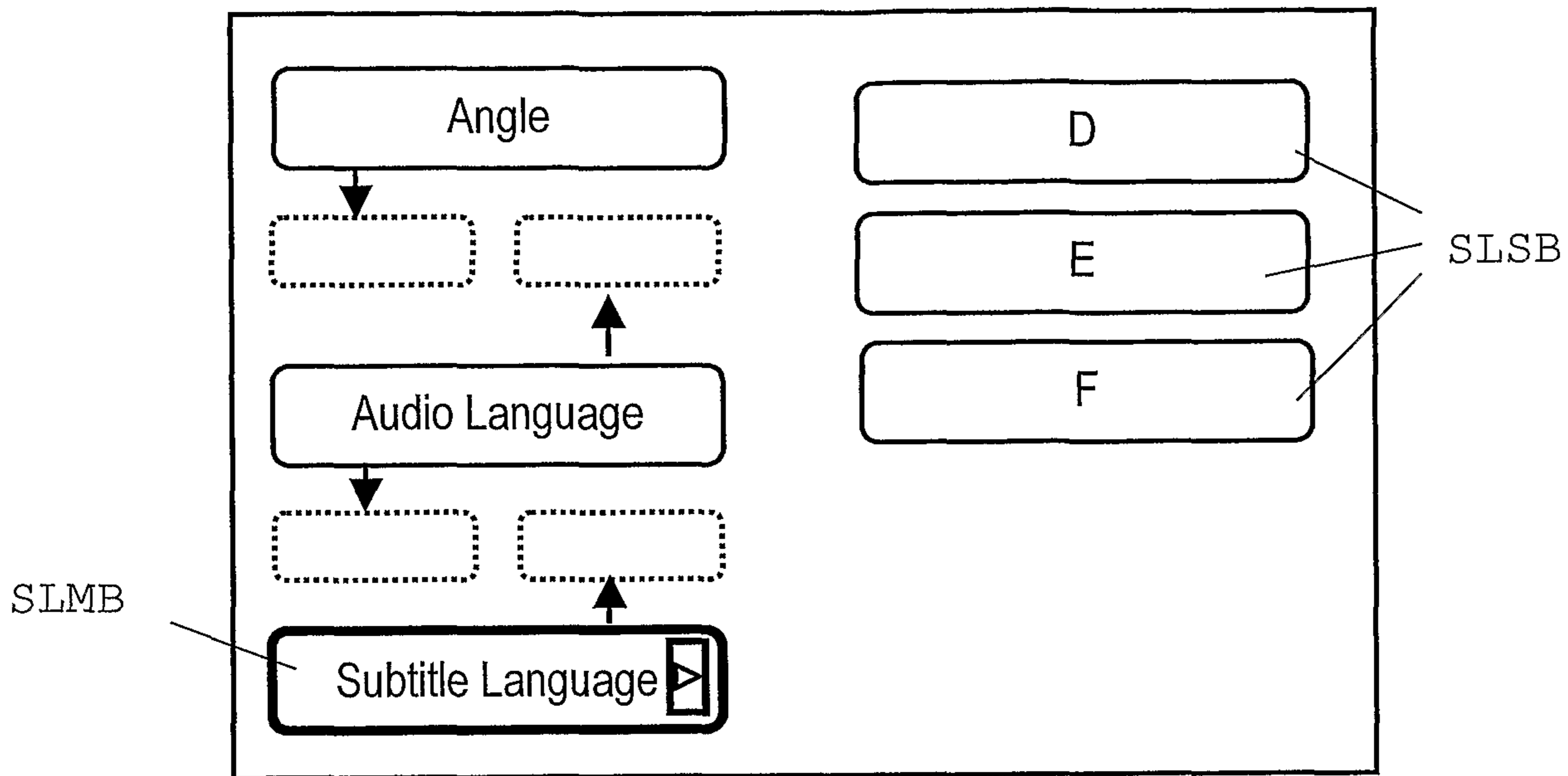

Fig. 20

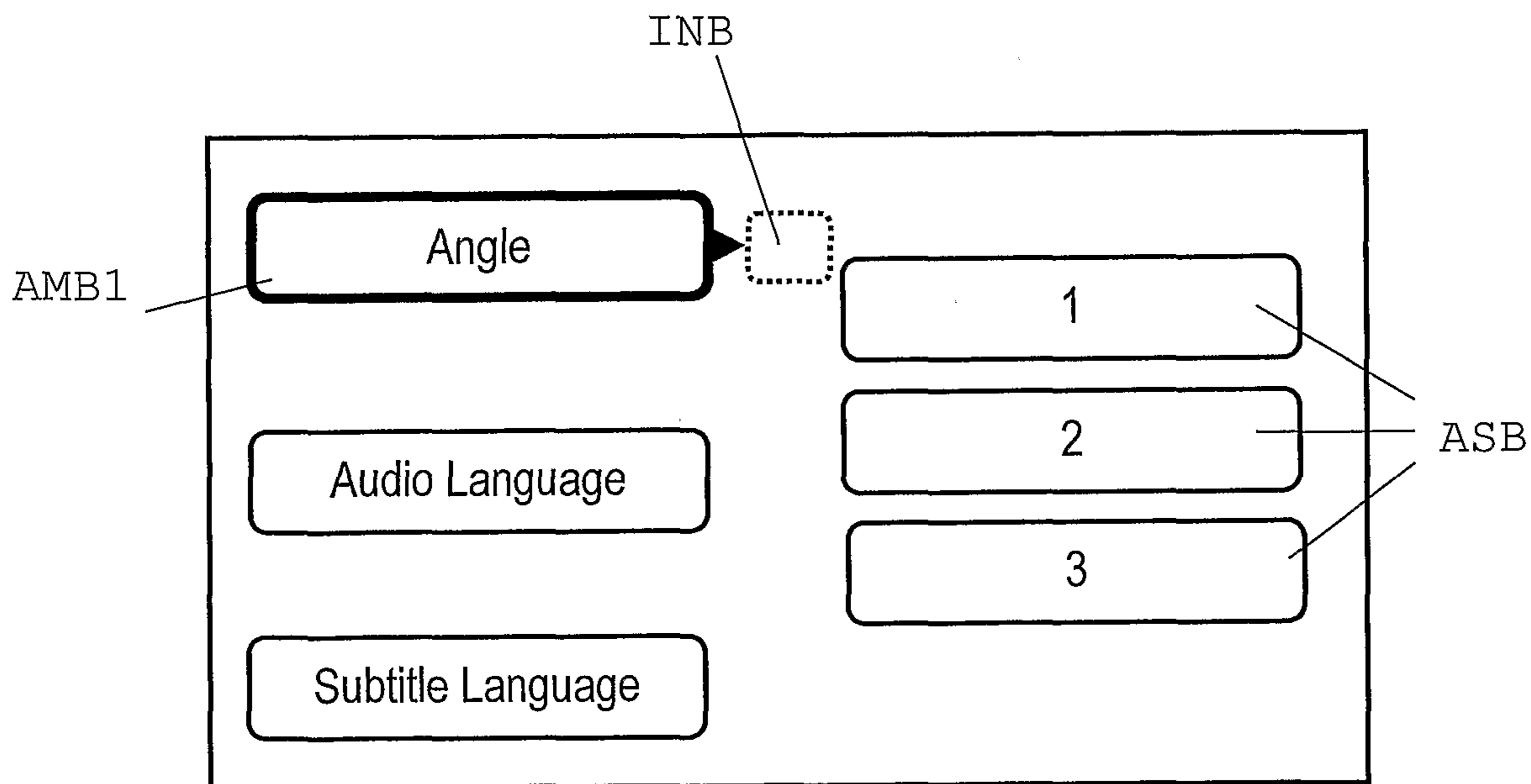

Fig. 21

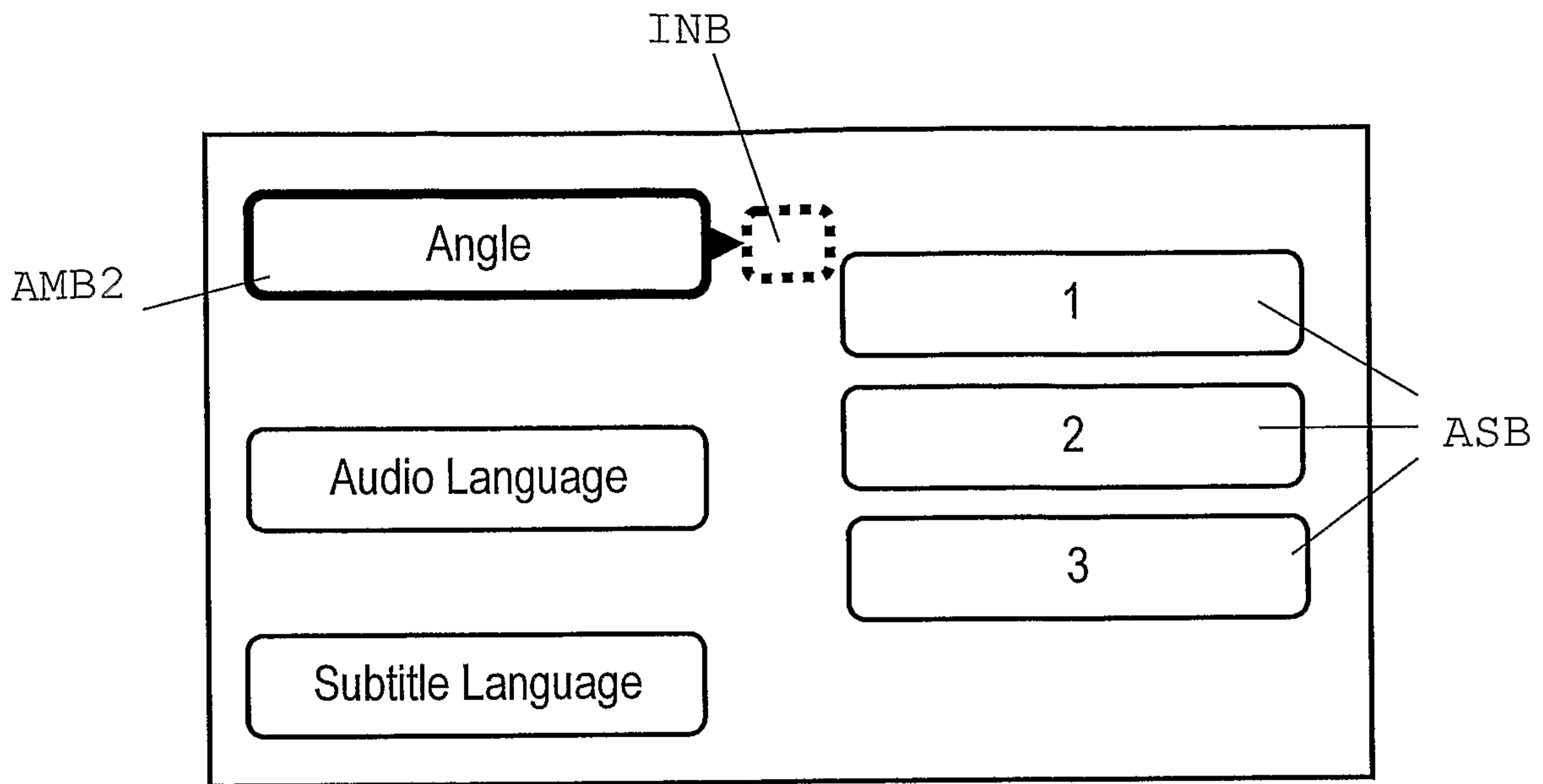

Fig. 22

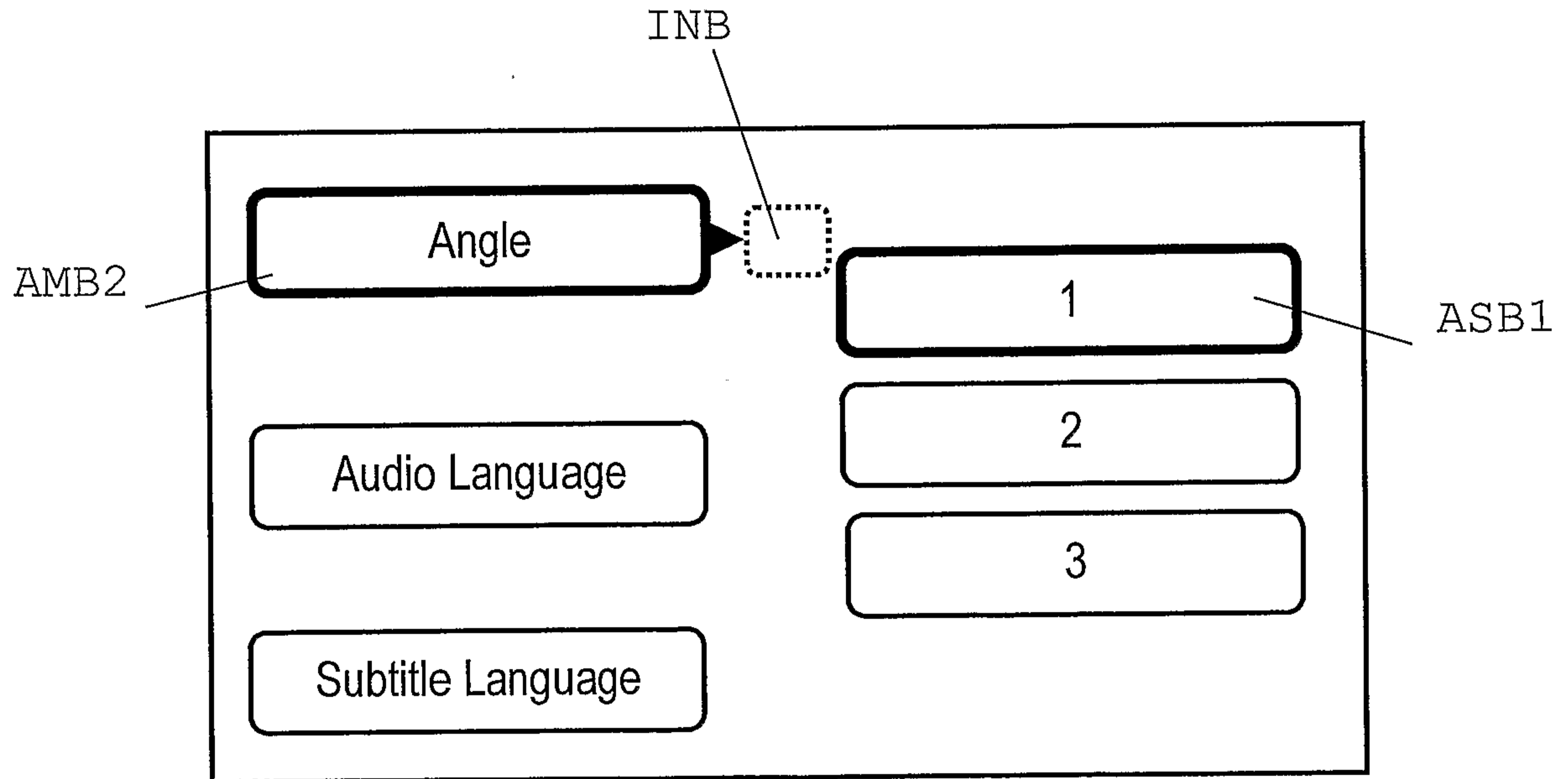

Fig. 23

