



US00D503752S

(12) **United States Design Patent**  
**Chiappetta et al.**

(10) **Patent No.:** **US D503,752 S**

(45) **Date of Patent:** **\*\* Apr. 5, 2005**

(54) **CHILDREN'S RIDE-ON TOY**

(75) Inventors: **Gary Chiappetta**, Hinsdale, IL (US);  
**Andrew Manocneo**, Chicago, IL (US);  
**Chuck Judy**, Chicago, IL (US); **Joel**  
**Koster**, Chicago, IL (US); **Hector**  
**Rodriguez**, Aurora, IL (US)

(73) Assignee: **Radio Flyer Inc.**, Chicago, IL (US)

(\*\*) Term: **14 Years**

(21) Appl. No.: **29/197,237**

(22) Filed: **Jan. 12, 2004**

(51) **LOC (7) Cl.** ..... **21-01**

(52) **U.S. Cl.** ..... **D21/430**

(58) **Field of Search** ..... D21/419-435,  
D21/447-452; 446/440, 465, 470; 280/1.12,  
87.01, 87.021

(56) **References Cited**

**U.S. PATENT DOCUMENTS**

D140,435 S \* 2/1945 Smith ..... 280/1.21  
2,755,095 A \* 7/1956 Douglas et al. .... 280/1.12

D221,565 S \* 8/1971 Dunbar ..... D21/430  
4,098,517 A \* 7/1978 Sortini ..... 280/1.12  
D275,300 S \* 8/1984 Mancini ..... D12/112  
D384,706 S \* 10/1997 Temple ..... D21/430  
D455,796 S \* 4/2002 Wu ..... D21/430

\* cited by examiner

*Primary Examiner*—Raphael Barkai

(74) *Attorney, Agent, or Firm*—Dla Piper Rudnick Gray  
Cary US LLP

(57) **CLAIM**

The ornamental design for a children's ride-on toy, as  
shown.

**DESCRIPTION**

FIG. 1 is a perspective view of the design;  
FIG. 2 is a top plan view of the design;  
FIG. 3 is a bottom plan view of the design;  
FIG. 4 is a front elevational view of the design;  
FIG. 5 is a rear elevational of the design;  
FIG. 6 is a left side view of the design; and,  
FIG. 7 is a right side view of the design.

**1 Claim, 4 Drawing Sheets**

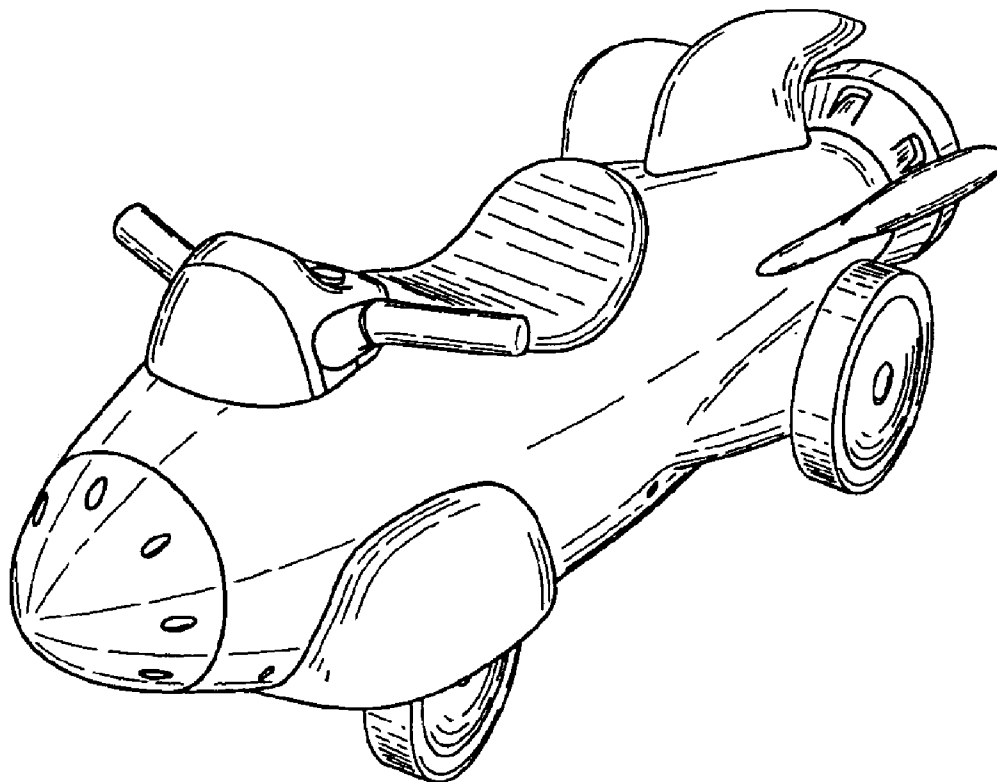

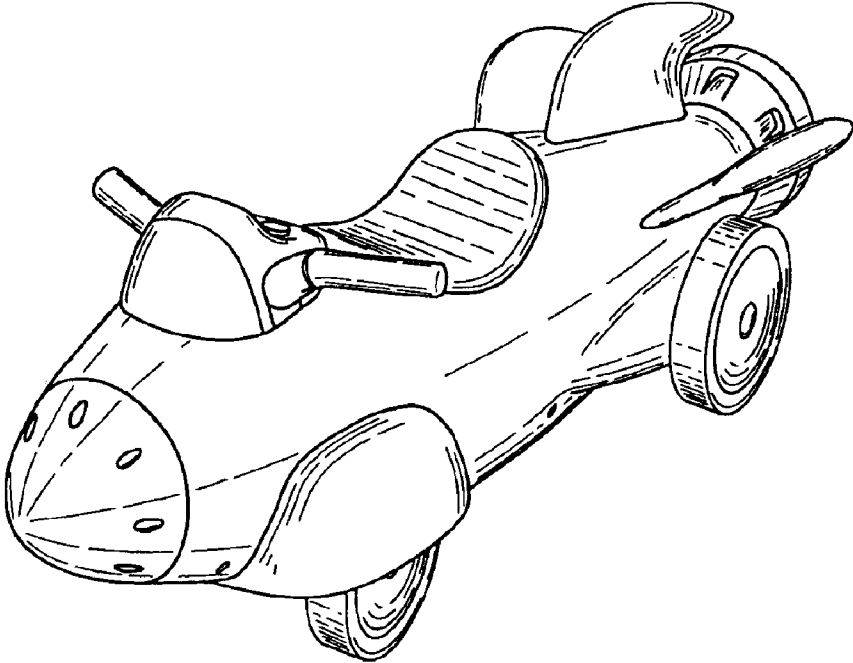

FIG. 1

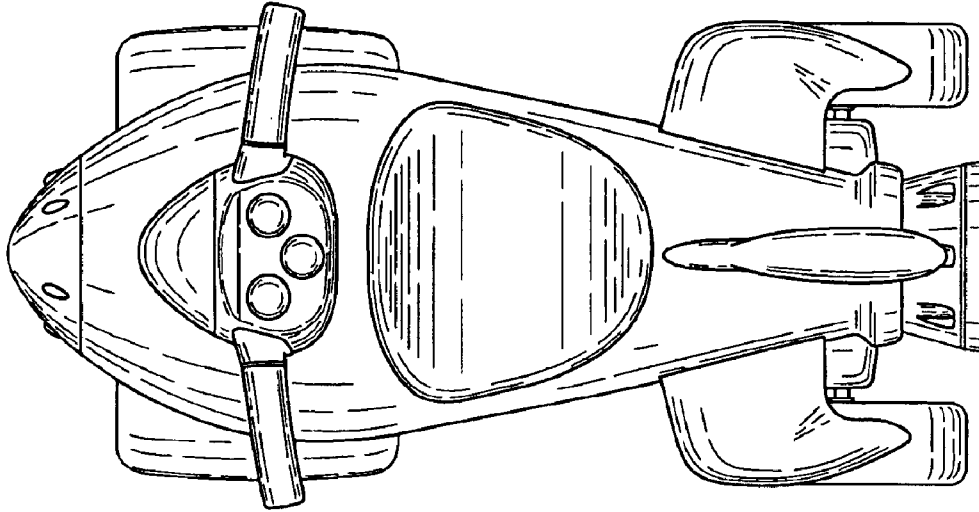

FIG. 2

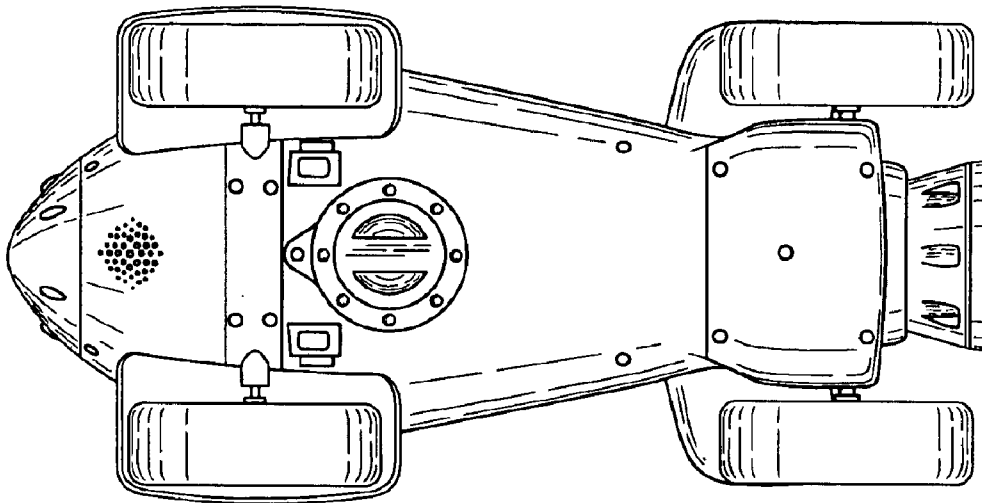

FIG. 3

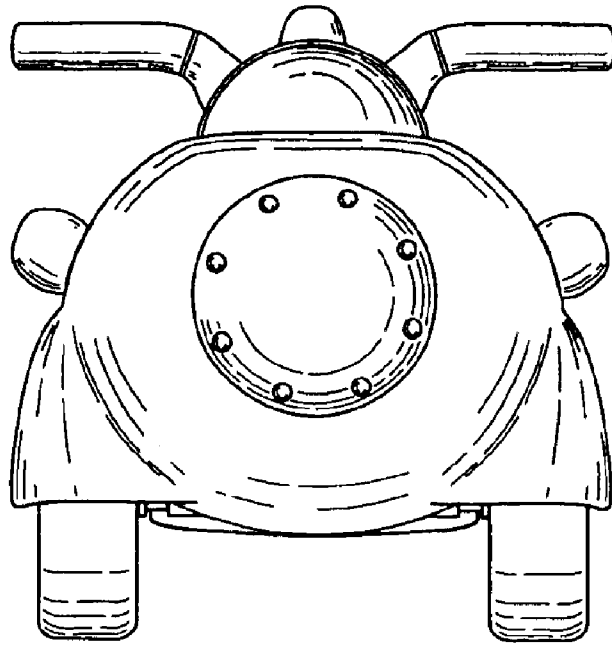

FIG. 4

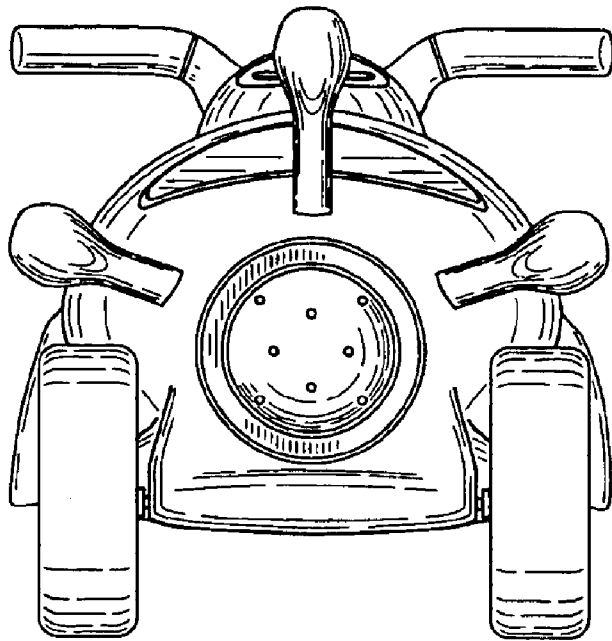

FIG. 5

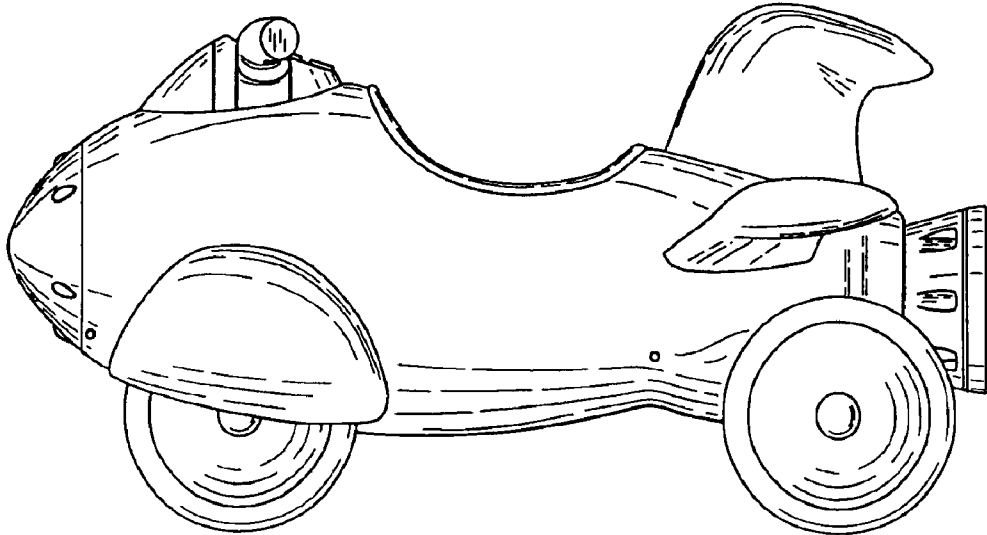

FIG. 6

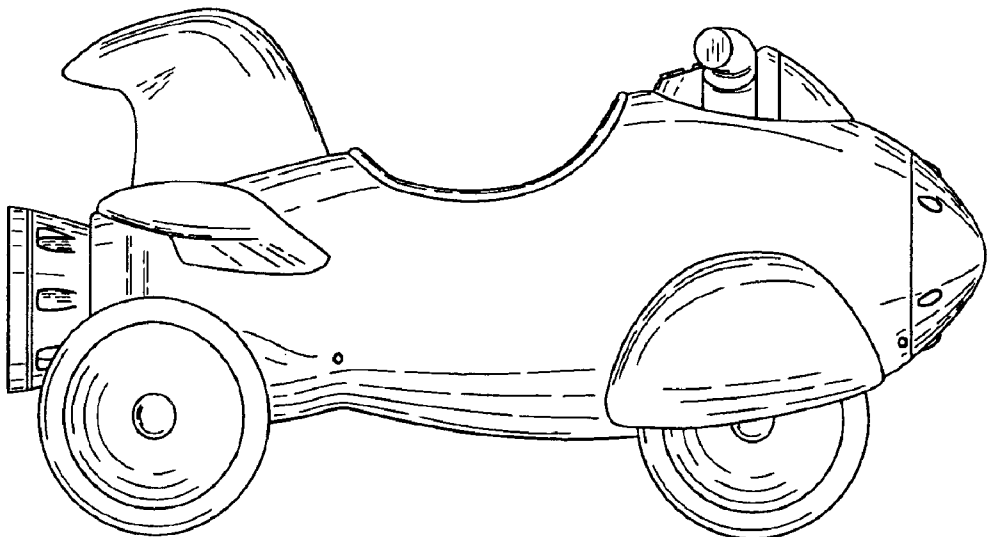

FIG. 7