



(12) **United States Design Patent**
Thomas et al.

(10) **Patent No.:** **US D763,579 S**
(45) **Date of Patent:** **** Aug. 16, 2016**

(54) **HAIR BRUSH**

(71) Applicants: **Eli C. Thomas**, Los Angeles, CA (US);
Kyung I. Cho, Los Angeles, CA (US)

(72) Inventors: **Eli C. Thomas**, Los Angeles, CA (US);
Kyung I. Cho, Los Angeles, CA (US)

(73) Assignee: **ECT Beauty, LLC**, Los Angeles, CA (US)

(**) Term: **14 Years**

(21) Appl. No.: **29/524,123**

(22) Filed: **Apr. 16, 2015**

(51) **LOC (10) Cl.** **04-02**

(52) **U.S. Cl.**
USPC **D4/133**

(58) **Field of Classification Search**

USPC D4/100, 102, 127-135, 136, 138, 199;
D7/393; D8/47, 75, 82, 83, 107, 300,
D8/307-313; D9/723-729; D19/100, 108,
D19/115, 125; D24/200, 211, 214
CPC A46B 5/00; A46B 5/02; A46B 5/021;
A46B 9/00; A46B 9/02; A46B 9/021; A46B
9/023; A46B 9/025; A46B 9/026; A46B
9/028; A46B 11/00; A46B 11/0006; A46B
11/001; A46B 13/00; A46B 13/001; A46B
13/02; A46B 13/023; A46B 15/0002; A46B
2200/10; A46B 2200/102; A46B 2200/1033;
A46B 2200/104; A46B 2200/1046; A46B
2200/30; A46B 2200/3006; A46B 2200/3013;
A46B 2200/3033; A46B 2200/3093

See application file for complete search history.

(56) **References Cited**

U.S. PATENT DOCUMENTS

| | | | |
|-------------------|---------|------------------|------------------------|
| D168,917 S * | 2/1953 | Snyder | D4/136 |
| 3,346,901 A * | 10/1967 | Fay | A46B 15/00 15/160 |
| D252,298 S * | 7/1979 | Baudon | D4/134 |
| D301,940 S * | 7/1989 | Fong | D4/132 |
| D307,217 S * | 4/1990 | Fong | D4/132 |
| D389,651 S * | 1/1998 | Chan | D4/138 |
| D533,722 S * | 12/2006 | Chen | D4/133 |
| D637,818 S * | 5/2011 | Mercier | D4/136 |
| 8,627,537 B2 * | 1/2014 | Mercier | A46B 9/02 132/120 |
| 2002/0004964 A1 * | 1/2002 | Luchino | A46B 3/00 15/167.1 |
| 2009/0188062 A1 * | 7/2009 | Chudzik | A46B 7/023 15/143.1 |
| 2013/0131559 A1 * | 5/2013 | Vandenbelt | A61N 5/0617 601/2 |

* cited by examiner

Primary Examiner — Catheri Oliver-Garcia

Assistant Examiner — Rebekah Caruso

(74) *Attorney, Agent, or Firm* — Philip H. Haymond

(57) **CLAIM**

We claim the ornamental design for a hair brush, as shown and described.

DESCRIPTION

FIG. 1 is a perspective view illustrating a hair brush of the present invention;

FIG. 2 is a bottom view of the hair brush of FIG. 1;

FIG. 3 is a top view of the hair brush of FIG. 1;

FIG. 4 is front view of the hair brush of FIG. 1;

FIG. 5 is left side view of the hair brush of FIG. 1;

FIG. 6 is right side view of the hair brush of FIG. 1; and,

FIG. 7 is rear view of the hair brush of FIG. 1.

1 Claim, 3 Drawing Sheets

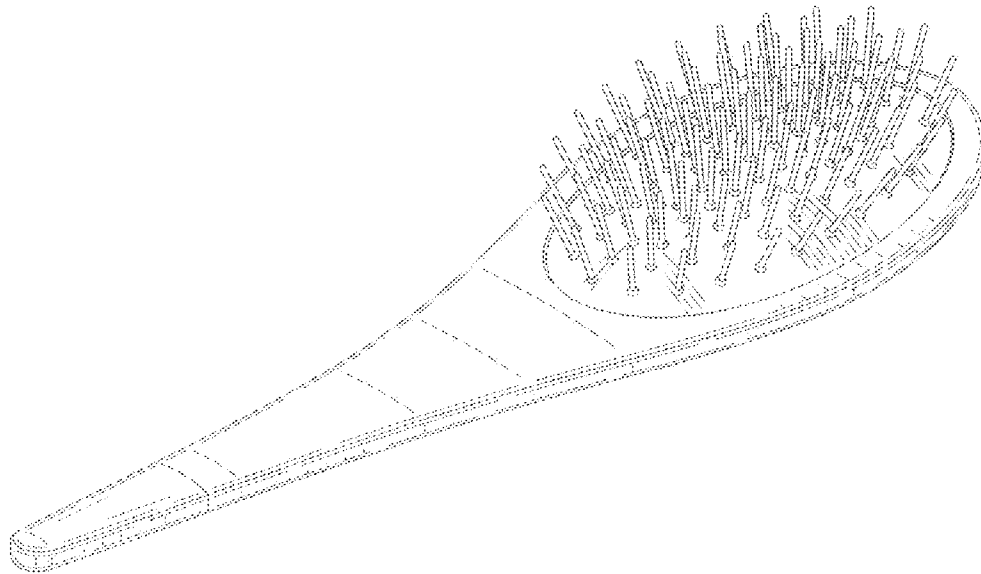

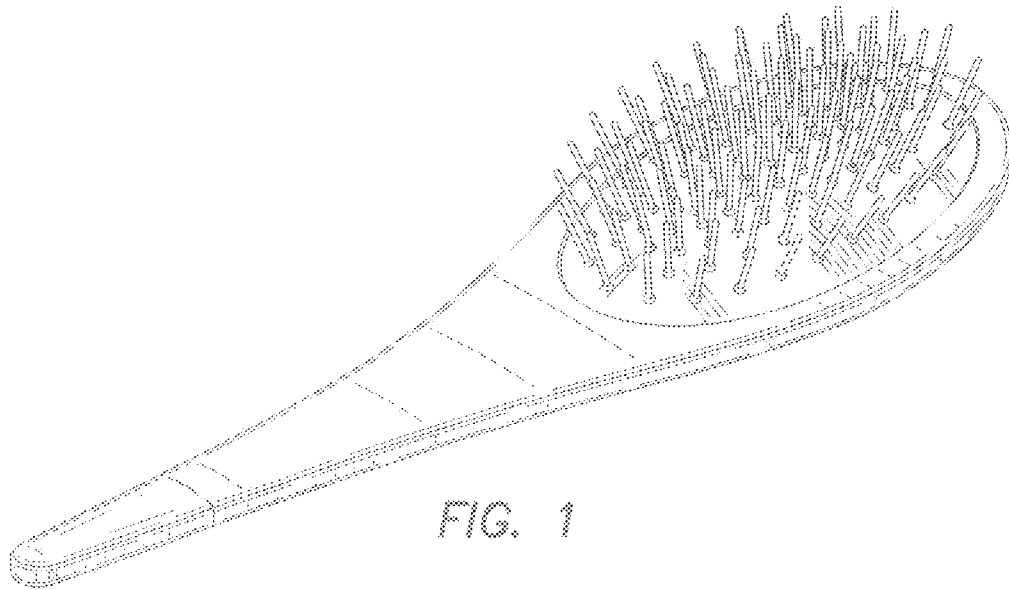

FIG. 1

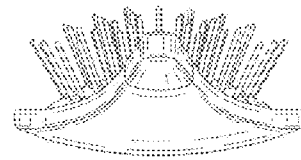

FIG. 2

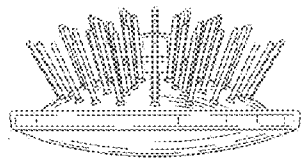

FIG. 3

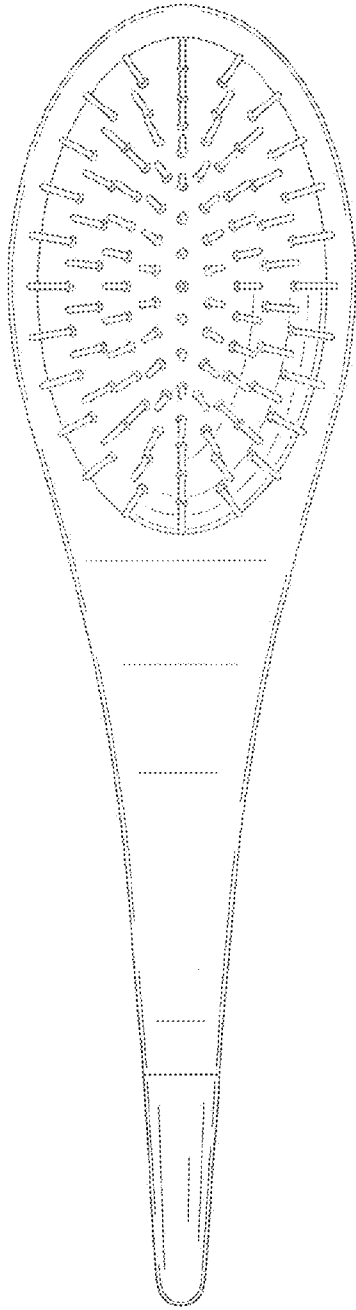

FIG. 4

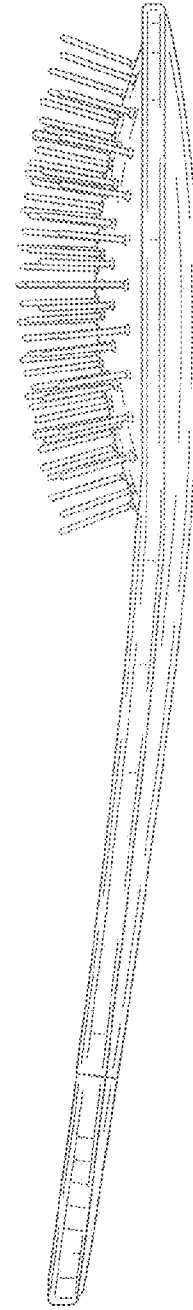

FIG. 5

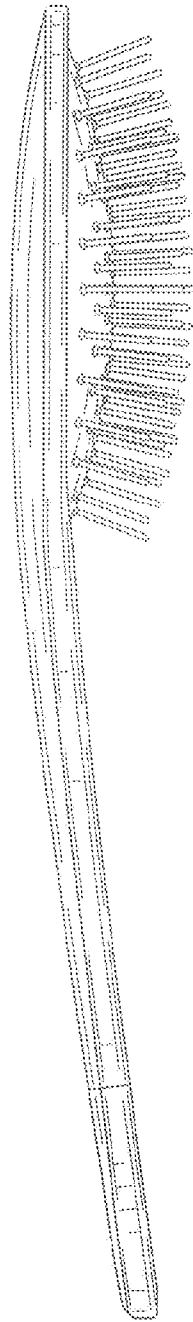

FIG. 6

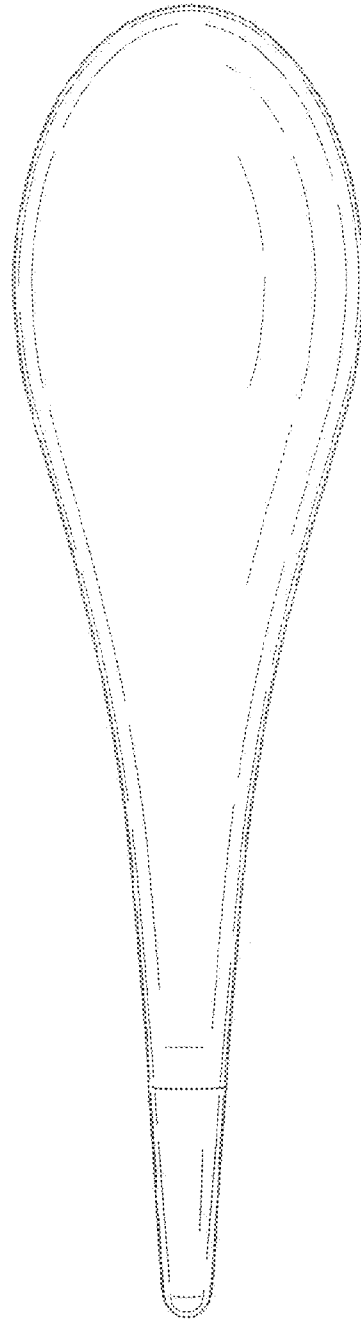

FIG. 7