



US00D724922S

(12) **United States Design Patent**  
**Alamilla**

(10) **Patent No.:** **US D724,922 S**

(45) **Date of Patent:** **\*\* Mar. 24, 2015**

(54) **GRINDER ATTACHMENT**

(71) Applicant: **Eder Alamilla**, San Antonio, FL (US)

(72) Inventor: **Eder Alamilla**, San Antonio, FL (US)

(\*\*) Term: **14 Years**

(21) Appl. No.: **29/452,726**

(22) Filed: **Apr. 20, 2013**

(51) **LOC (10) Cl.** ..... **08-03**

(52) **U.S. Cl.**  
USPC ..... **D8/70**

(58) **Field of Classification Search**

USPC ..... D8/20, 61, 62, 63, 70; D15/124, 125,  
D15/126, 132, 138, 139, 140; 30/307, 347,  
30/355, 388, 389, 390; 451/259, 344, 357,  
451/358, 359, 420, 490, 510, 513, 540, 541,  
451/542, 548, 550; 81/54, 57, 57.11, 57.3;  
173/164, 169, 170, 213, 216, 217

See application file for complete search history.

(56) **References Cited**

**U.S. PATENT DOCUMENTS**

D287,330	S	*	12/1986	Karden et al.	.....	D8/62
5,125,190	A	*	6/1992	Buser et al.	.....	451/456
D334,330	S	*	3/1993	Moshammer	.....	D8/70
D352,048	S	*	11/1994	Goebel	.....	D15/126
D456,685	S	*	5/2002	Keller	.....	D8/70
D522,827	S	*	6/2006	Corcoran	.....	D8/62
D537,691	S	*	3/2007	Lamprecht et al.	.....	D8/70
D537,692	S	*	3/2007	Aglassinger	.....	D8/70

D623,033	S	*	9/2010	Trochum	.....	D8/62
D694,606	S	*	12/2013	Salomon et al.	.....	D8/70
8,702,478	B2	*	4/2014	Loveless et al.	.....	451/453
2005/0048884	A1	*	3/2005	Baker	.....	451/358
2009/0029635	A1	*	1/2009	Boeck et al.	.....	451/359

**FOREIGN PATENT DOCUMENTS**

EP	2208575	A1	*	7/2010	.....	B24B 23/00
JP	2010188463	A	*	9/2010	.....	B24B 23/00
WO	WO 2008113893	A2	*	9/2008	.....	B24B 23/00

\* cited by examiner

*Primary Examiner* — Philip S Hyder  
*Assistant Examiner* — Darlington Ly  
(74) *Attorney, Agent, or Firm* — Gulf Coast Intellectual Property Group

(57) **CLAIM**

The ornamental design for a grinder attachment, as shown and described.

**DESCRIPTION**

FIG. 1 is a perspective view of the present invention; FIG. 2 is a front elevation view thereof; FIG. 3 is a rear elevation view thereof; FIG. 4 is a left side elevation view thereof; FIG. 5 is a right side elevation view thereof; FIG. 6 is top plan view thereof; and, FIG. 7 is a bottom plan view thereof. The broken lines shown in the drawings illustrate environmental structure for the grinder attachment that forms no part of the claimed design.

**1 Claim, 4 Drawing Sheets**

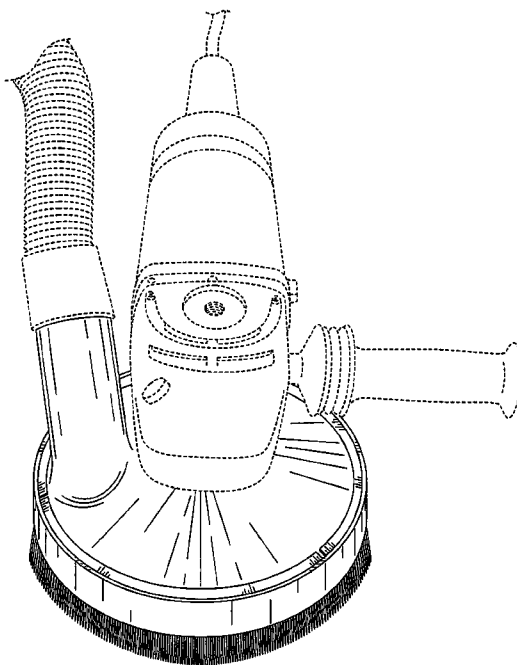

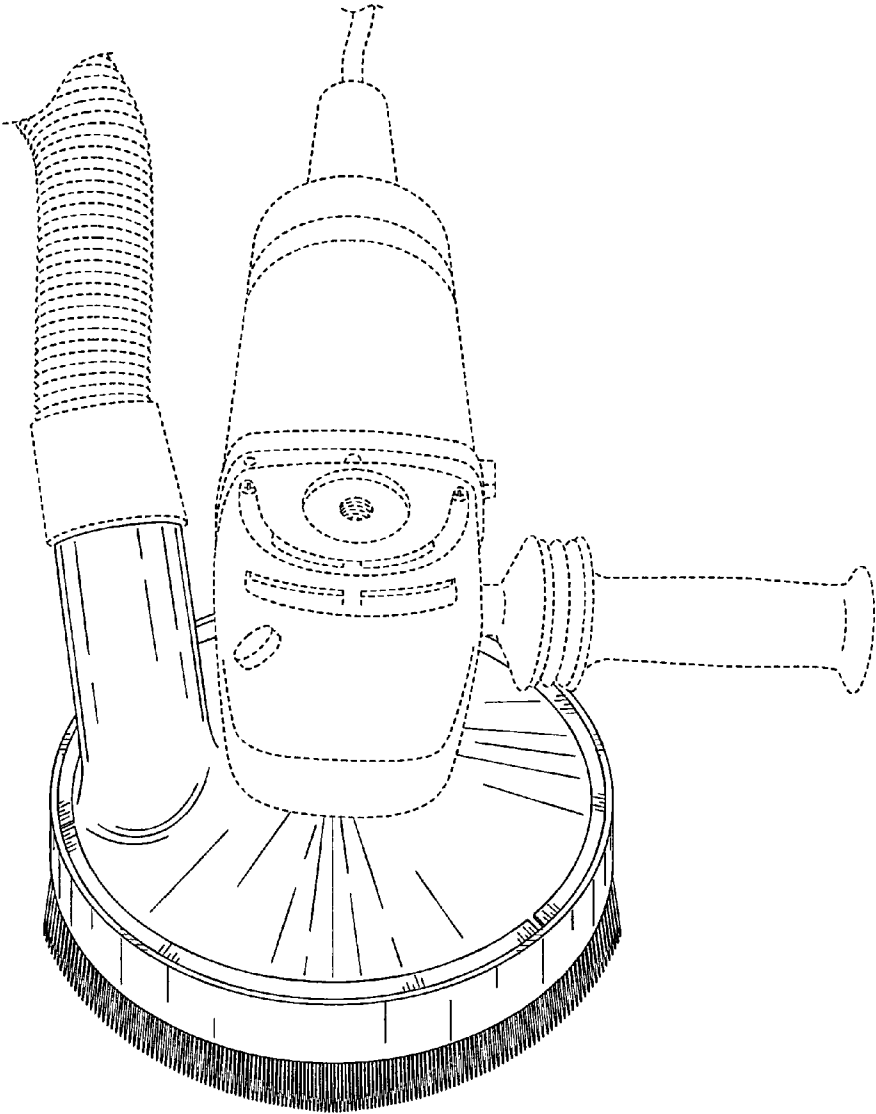

FIG. 1

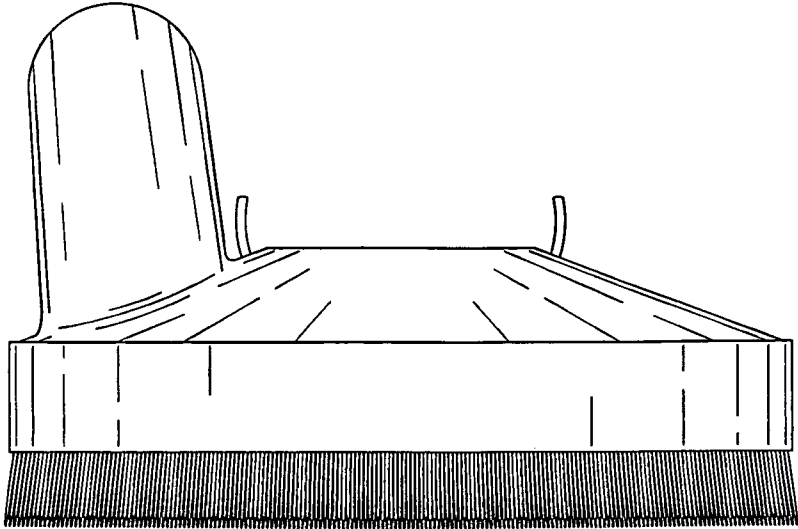

FIG. 2

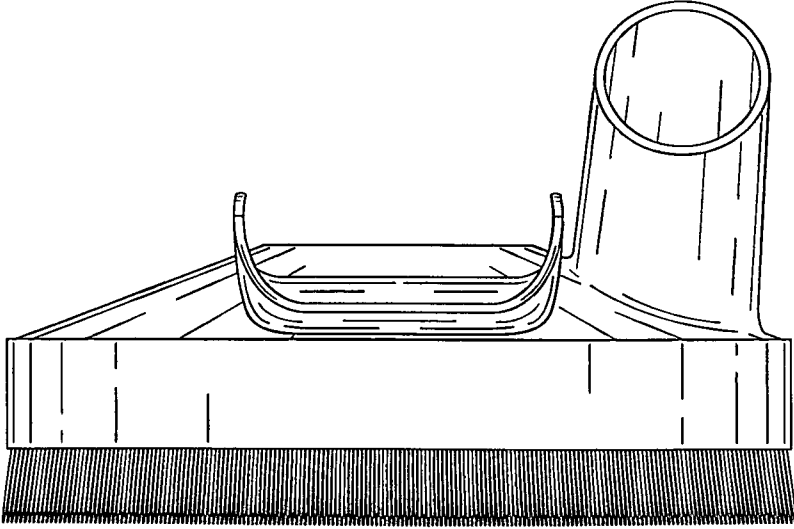

FIG. 3

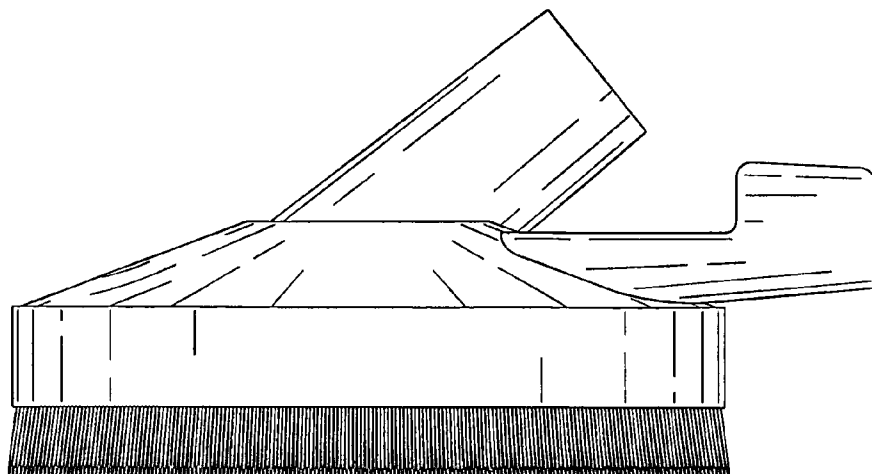

FIG. 4

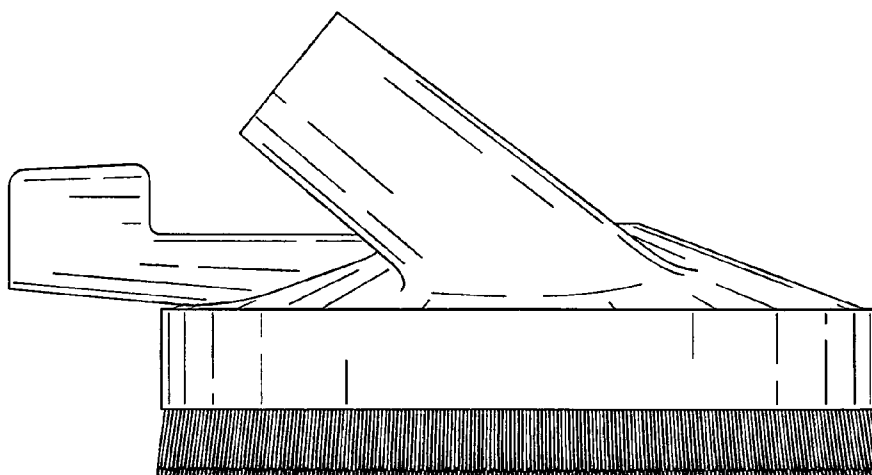

FIG. 5

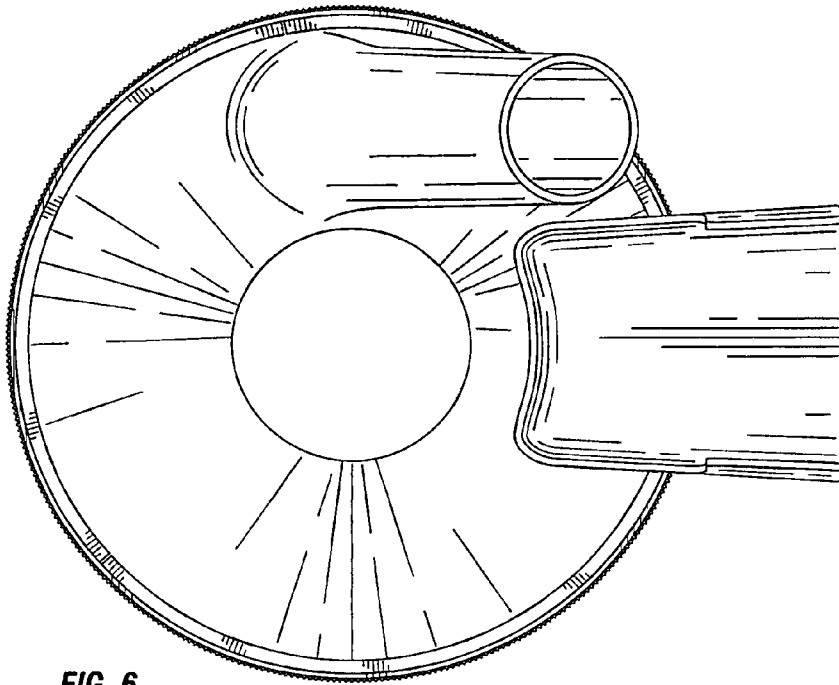

FIG. 6

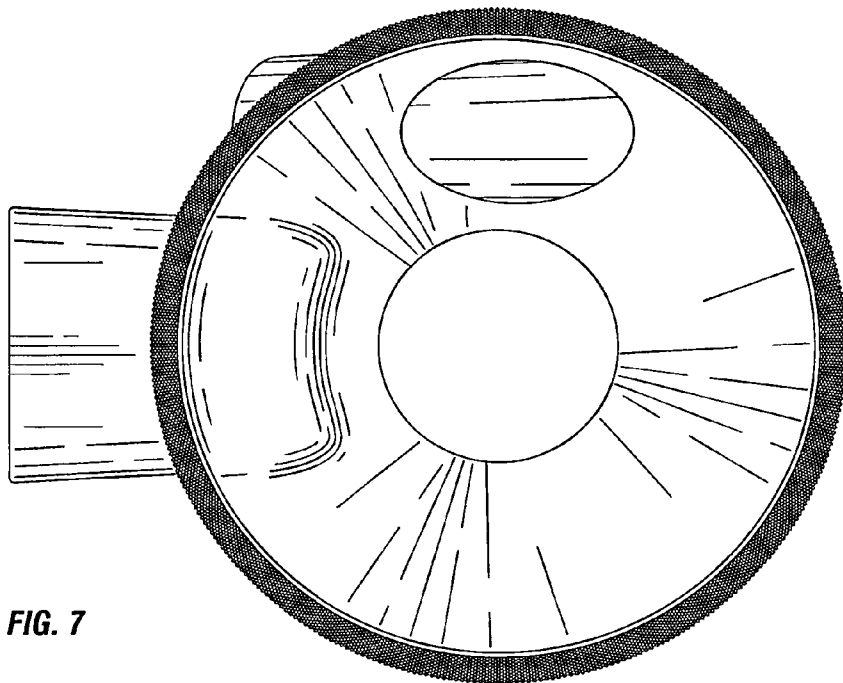

FIG. 7