



US00D795430S

(12) **United States Design Patent**
Butz

(10) **Patent No.:** **US D795,430 S**

(45) **Date of Patent:** **** Aug. 22, 2017**

(54) **INTERDENTAL CLEANER**

A61C 15/048; A61C 15/0069; A61C 15/0087; A61C 15/0093

See application file for complete search history.

(71) Applicant: **INTERBROS GMBH**, Schönau (DE)

(56) **References Cited**

(72) Inventor: **Jürgen Butz**, Schönau (DE)

U.S. PATENT DOCUMENTS

(73) Assignee: **INTERBROS GMBH**, Schönau (DE)

D536,529	S *	2/2007	Antler	D4/111
D594,984	S *	6/2009	Crossman	D24/152
D674,610	S *	1/2013	Eatherton	D4/111
8,663,520	B2 *	3/2014	Kalbfeld	A46B 1/00 264/138

(**) Term: **15 Years**

(Continued)

(21) Appl. No.: **29/576,404**

FOREIGN PATENT DOCUMENTS

(22) Filed: **Sep. 2, 2016**

CN	303535305	*	4/2015
WO	WO D087426-001	*	8/2015

(Continued)

Related U.S. Application Data

Primary Examiner — Wan Laymon

(62) Division of application No. 35/500,137 (U.S. filing date under 35 U.S.C. 384), and having an international filing date of Aug. 11, 2015.

(74) *Attorney, Agent, or Firm* — McGlew and Tuttle, P.C

(30) **Foreign Application Priority Data**

(57) **CLAIM**

The ornamental design for an interdental cleaner, as shown and described.

Feb. 13, 2015 (EM) 001430102

Feb. 27, 2015 (EM) 001430771

(51) **LOC (10) Cl.** **24-02**

(52) **U.S. Cl.**

USPC **D24/152**; D4/111

(58) **Field of Classification Search**

USPC D24/152, 156, 176, 133, 146-147, 119;
D4/104-107, 109, 111, 128, 136; D28/68

CPC A46B 3/00; A46B 1/00; A46B 5/00; A46B 5/0062; A46B 5/02; A46B 5/021; A46B 5/026; A46B 2200/108; A46B 2200/1066; A61C 15/00; A61C 15/02; A61C 15/047;

DESCRIPTION

FIG. 1 is a perspective view of my design;
 FIG. 2 is a front view of the design of FIG. 1;
 FIG. 3 is a rear view of the design of FIG. 1;
 FIG. 4 is a top view of the design of FIG. 1;
 FIG. 5 is a bottom view of the design of FIG. 1;
 FIG. 6 is a left view of the design of FIG. 1;
 FIG. 7 is a right view of the design of FIG. 1;
 FIG. 8 is a perspective view of another design;
 FIG. 9 is a front view of the design of FIG. 8;
 FIG. 10 is a rear view of the design of FIG. 8;
 FIG. 11 is a top view of the design of FIG. 8;
 FIG. 12 is a bottom view of the design of FIG. 8;
 FIG. 13 is a left view of the design of FIG. 8;
 FIG. 14 is a right view of the design of FIG. 8;
 FIG. 15 is a perspective view of another design;
 FIG. 16 is a front view of the design of FIG. 15;

(Continued)

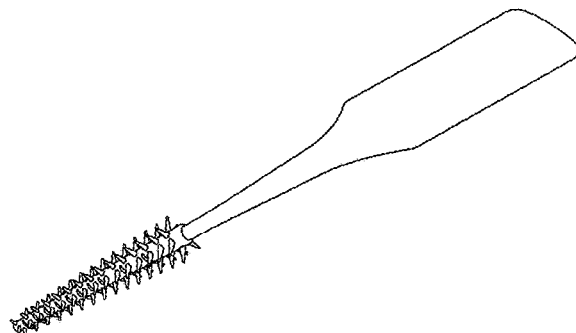
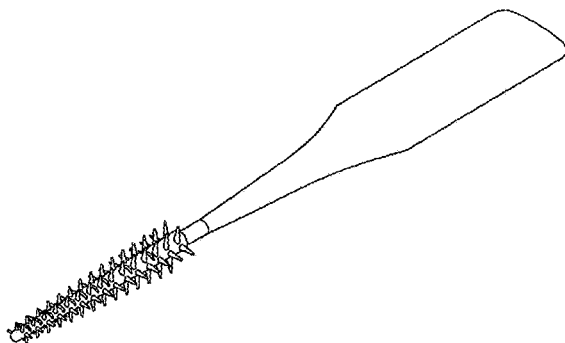

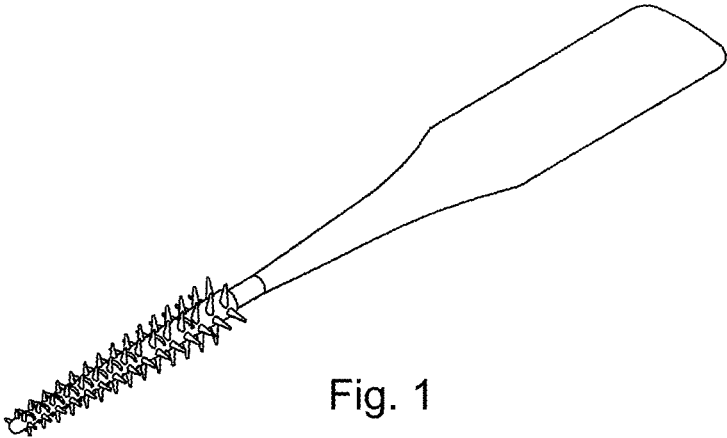

Fig. 1

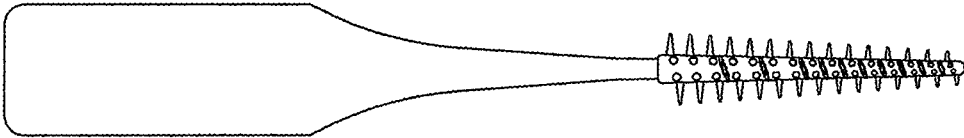

Fig. 2

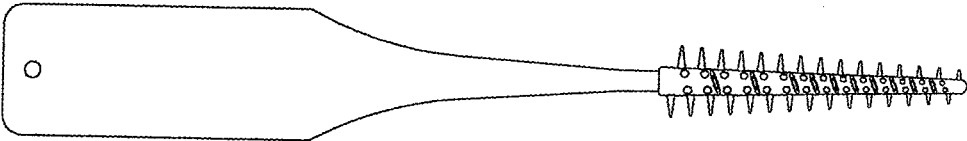

Fig. 3



Fig. 4

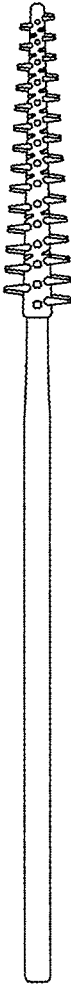

Fig. 5

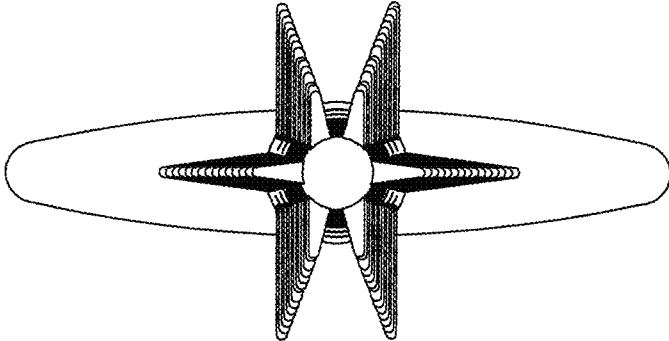

Fig. 6

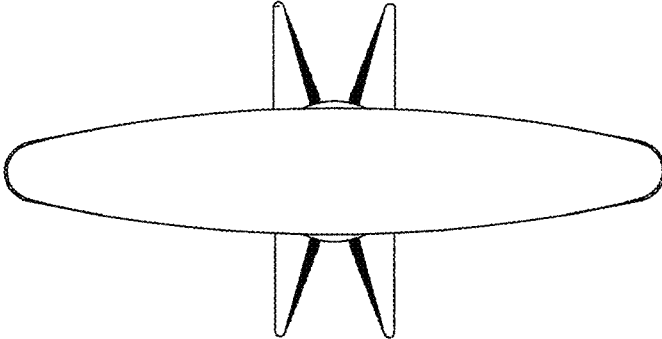

Fig. 7

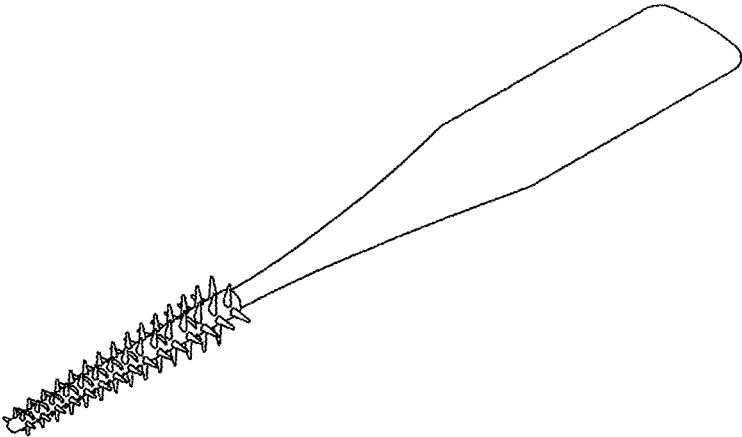

Fig. 8

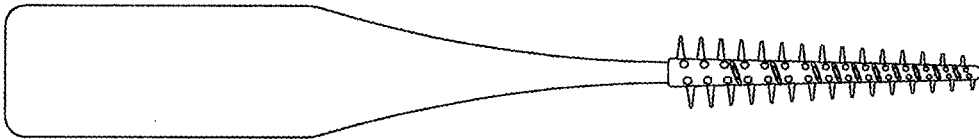

Fig. 9

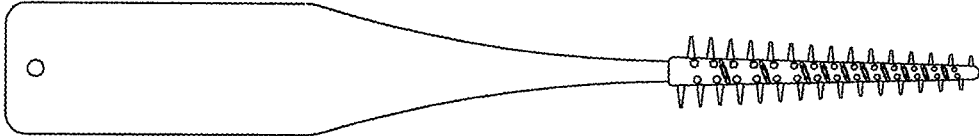

Fig. 10

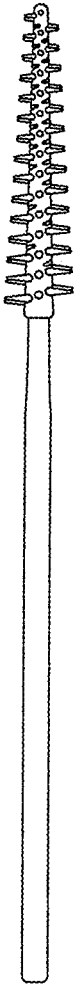

Fig. 11



Fig. 12

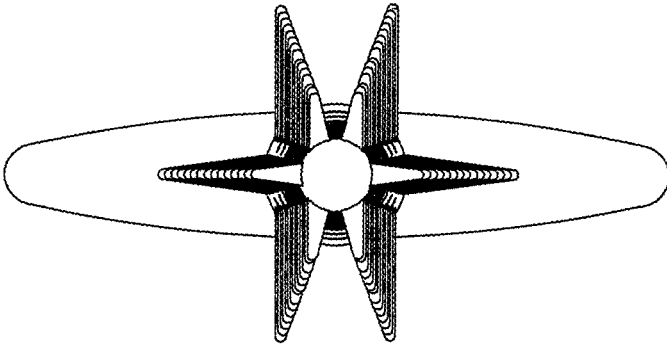

Fig. 13

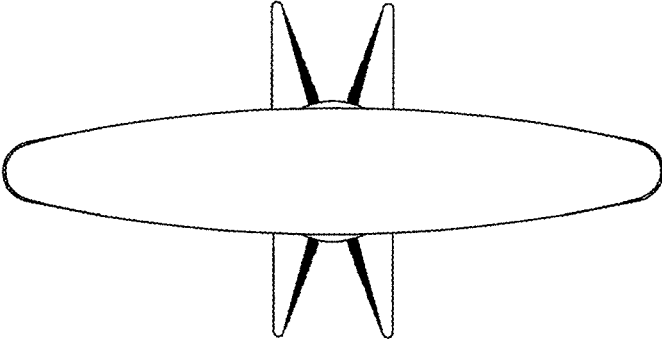

Fig. 14

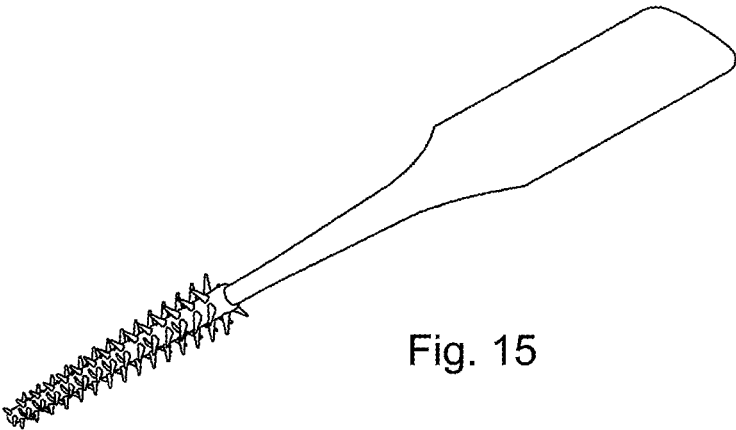

Fig. 15

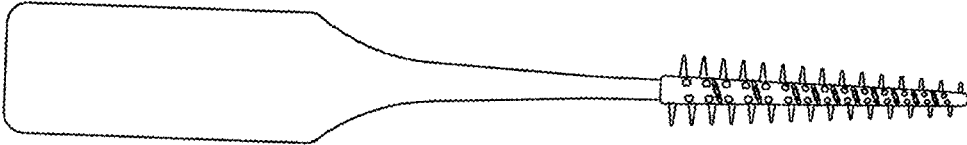

Fig. 16

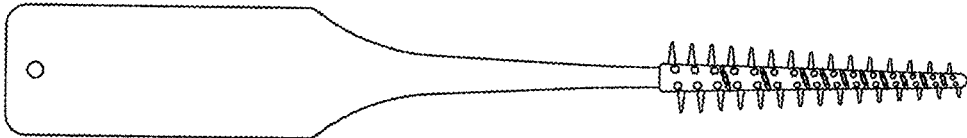

Fig. 17



Fig. 18

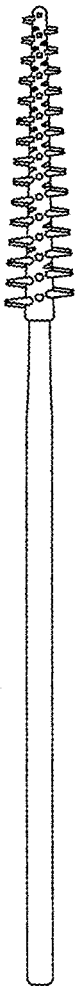

Fig. 19

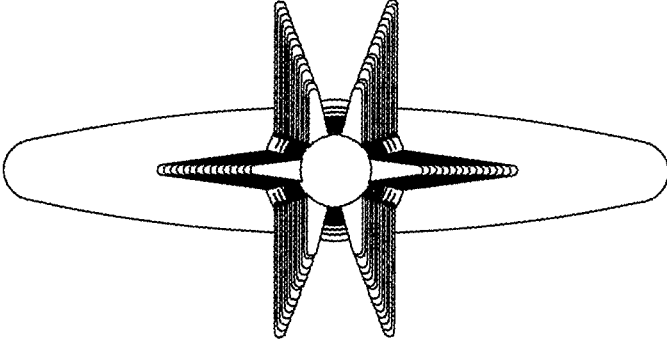

Fig. 20

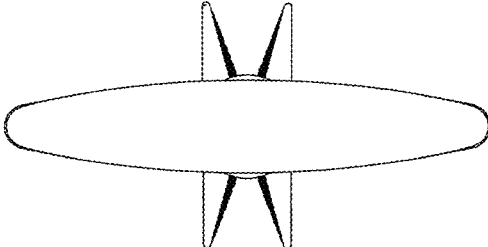

Fig. 21