

(21) Application No 9930647.4

(22) Date of Filing 24.12.1999

(30) Priority Data

(31) 9924071 (32) 12.10.1999 (33) GB

(71) Applicant(s)

**Roke Manor Research Limited**  
(Incorporated in the United Kingdom)  
Old Salisbury Lane, Romsey, Hampshire, SO51 0ZN,  
United Kingdom

**Nicholas WEBB**  
Hole Farm Cottage, Chilsham Lane,  
Bodle Street Green, Nr. Herstmon Ceux,  
EAST SUSSEX, BN27 4QJ, United Kingdom

(72) Inventor(s)

**Nicholas WEBB**  
**Peter Lockhart**

(51) INT CL<sup>7</sup>

G08C 23/00 // H04N 7/08

(52) UK CL (Edition R )

G4F F14

(56) Documents Cited

GB 2334133 A GB 2192743 A WO 99/00979 A1  
US 4807031 A

(58) Field of Search

UK CL (Edition R ) G4F F10XX F10X8 F14 , H4F FHT  
INT CL<sup>7</sup> G08C 23/00 23/02 , H04N 7/08 7/085  
On-line: WPI, EPODOC, JAPIO

(74) Agent and/or Address for Service

**Derek Allen**  
Siemens Shared Services Limited, Intellectual  
Property Department, Siemens House, Oldbury,  
BRACKNELL, Berkshire, RG12 8FZ, United Kingdom

(54) Abstract Title

**Interactive communications apparatus and method**

(57) The present invention uses an acoustic data transmission system channel for communicating with remote items such as toys or other novelty devices. Control data is embedded in an acoustic signal which is part of e.g. a television broadcast. The data in the tv sound is received by the toy 42, which is in the vicinity of a receiver 40. Operation of the toy can be modified upon receipt of the embedded data. The toy can thus react, speak and moves in response to the tv programme.

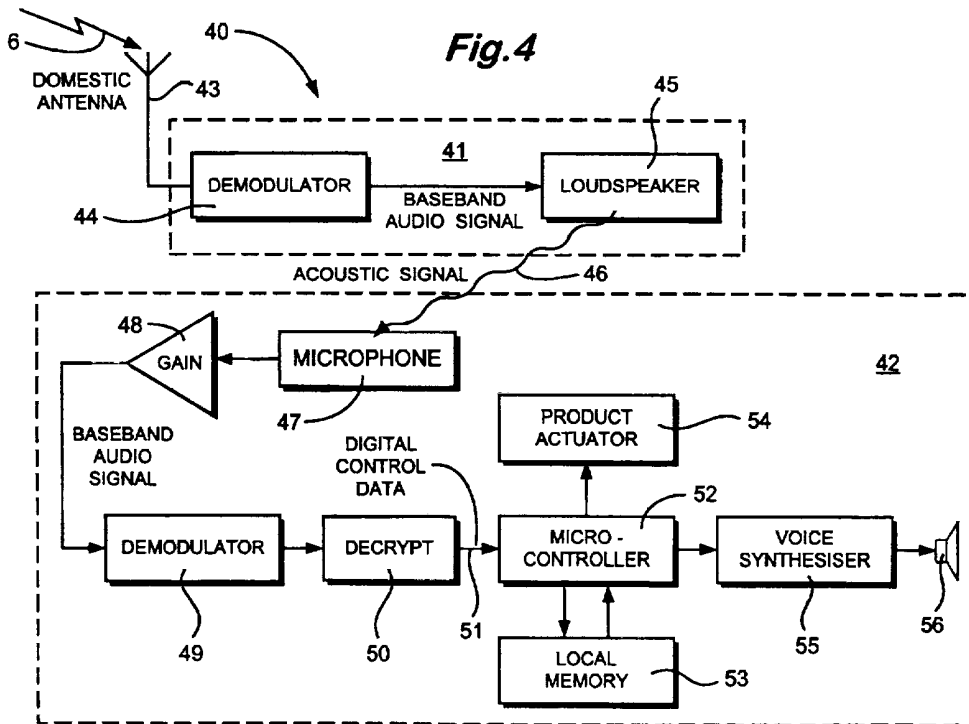

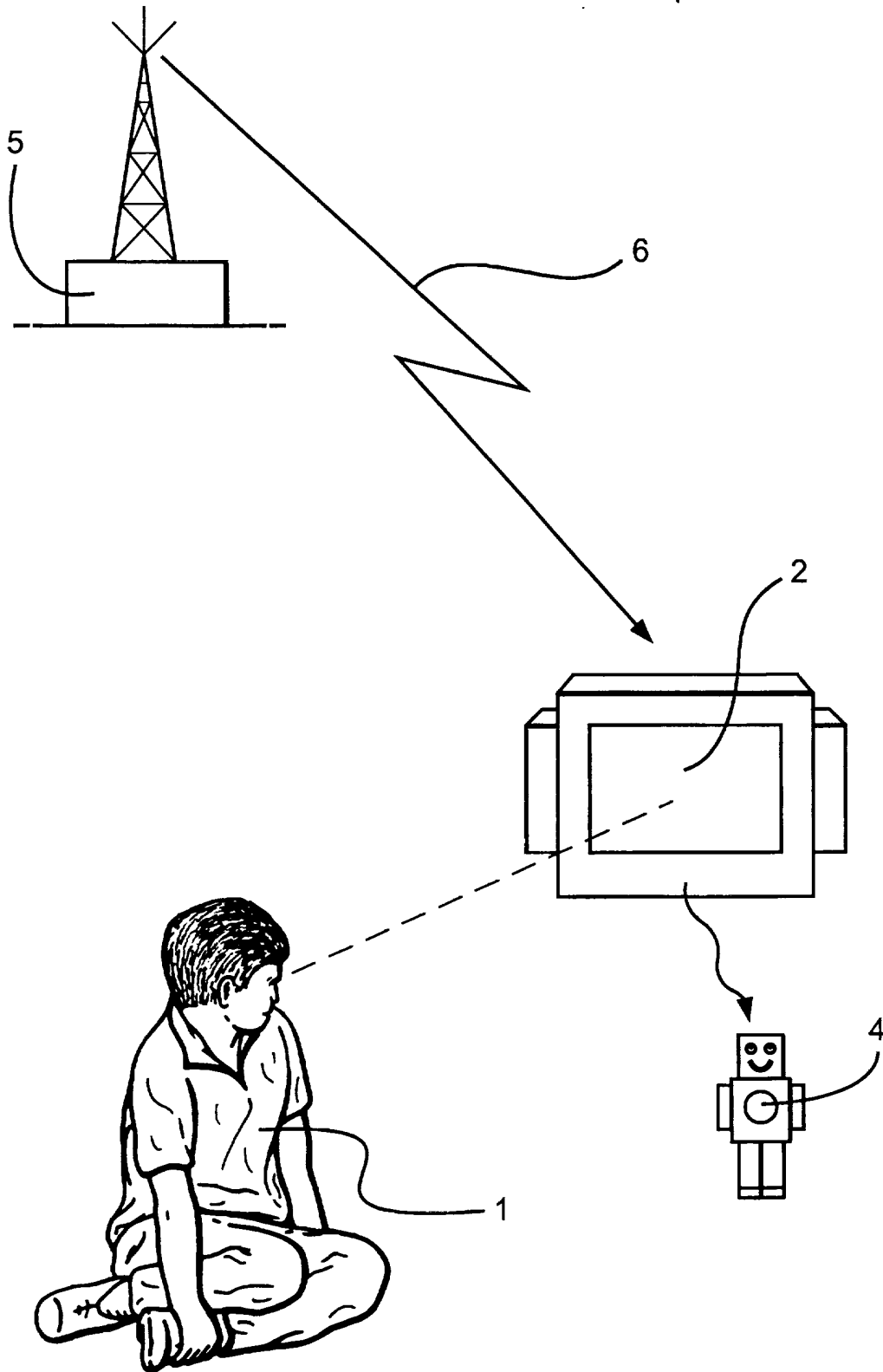

**Fig. 1**

Fig.2

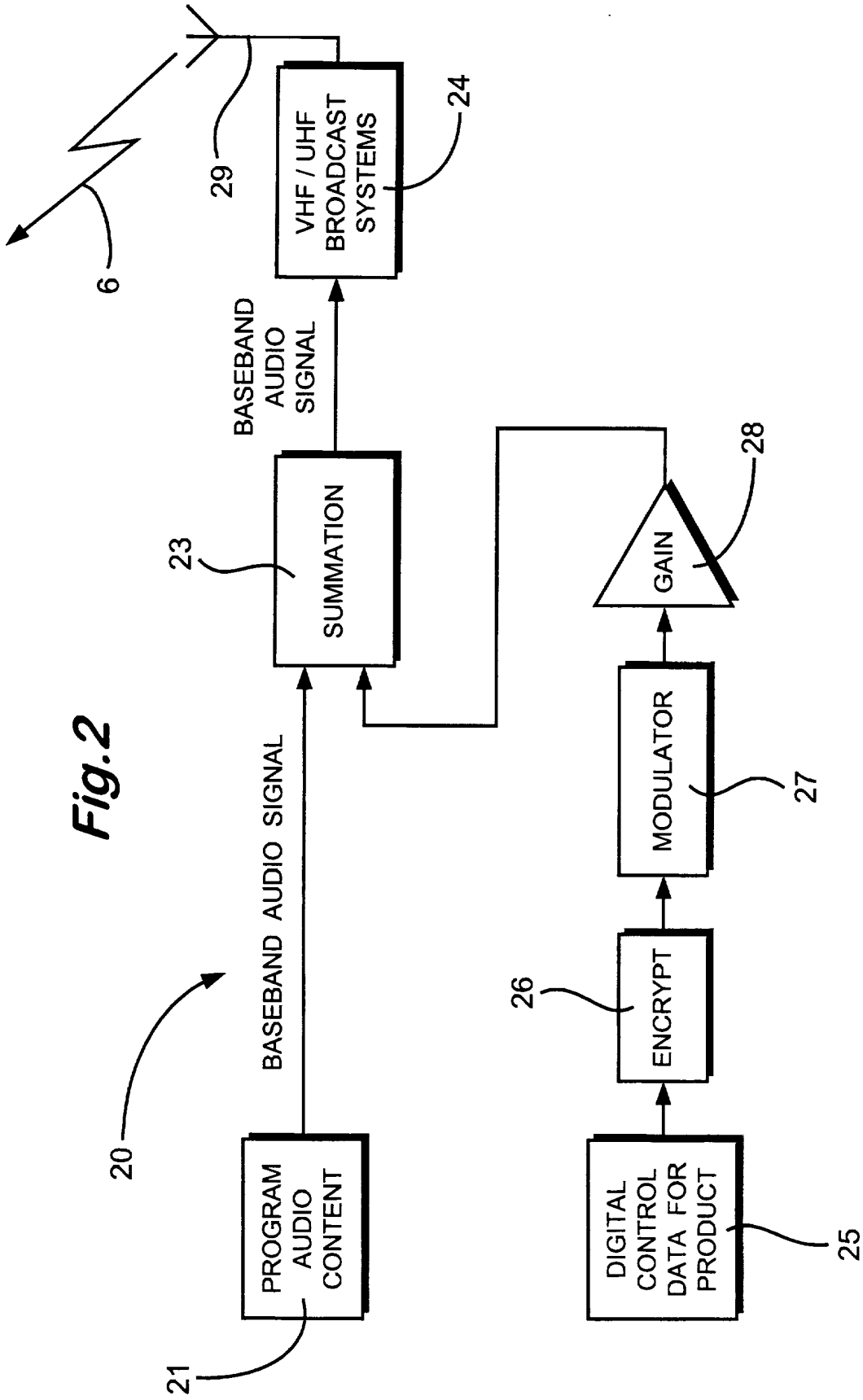
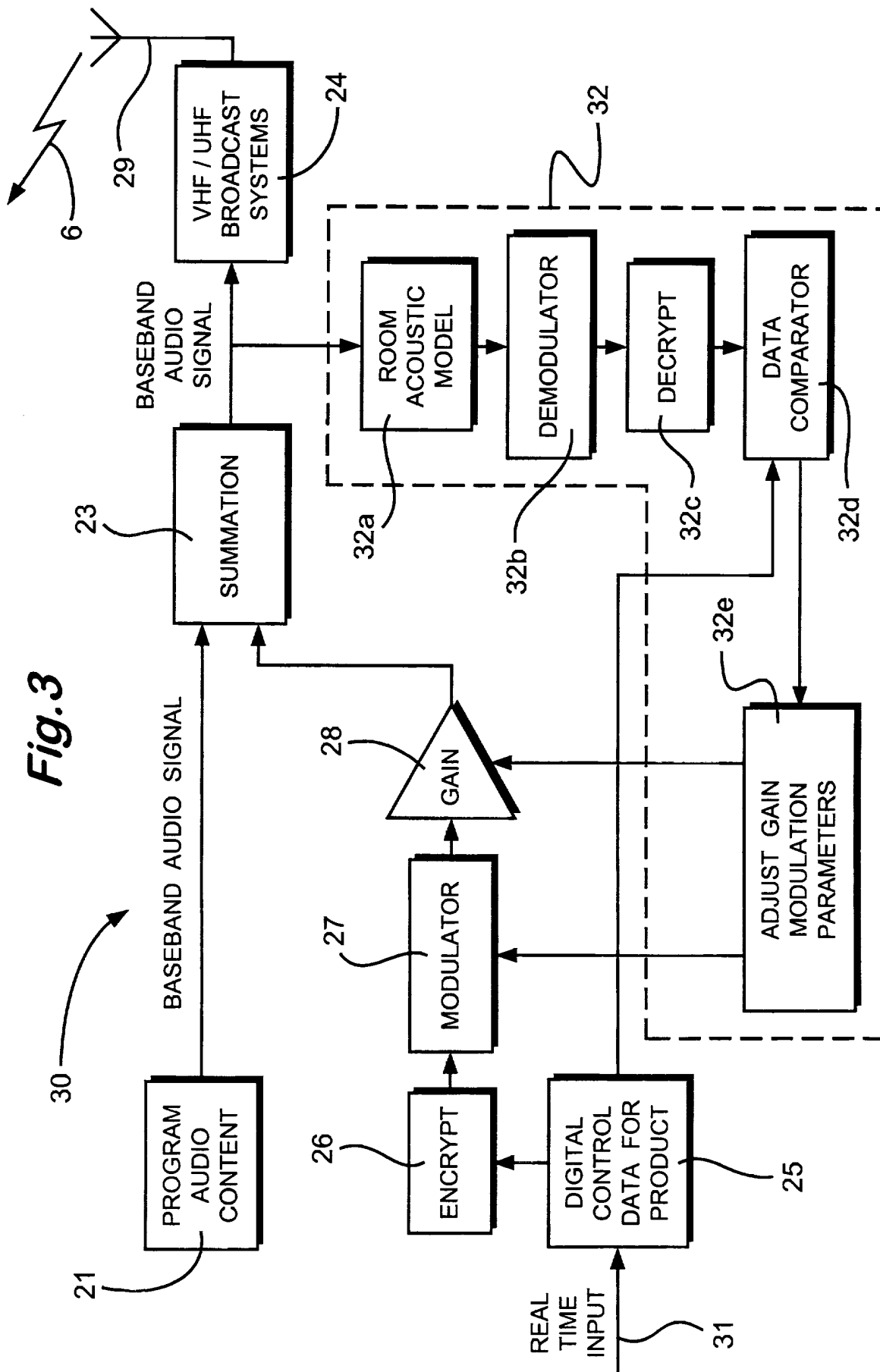
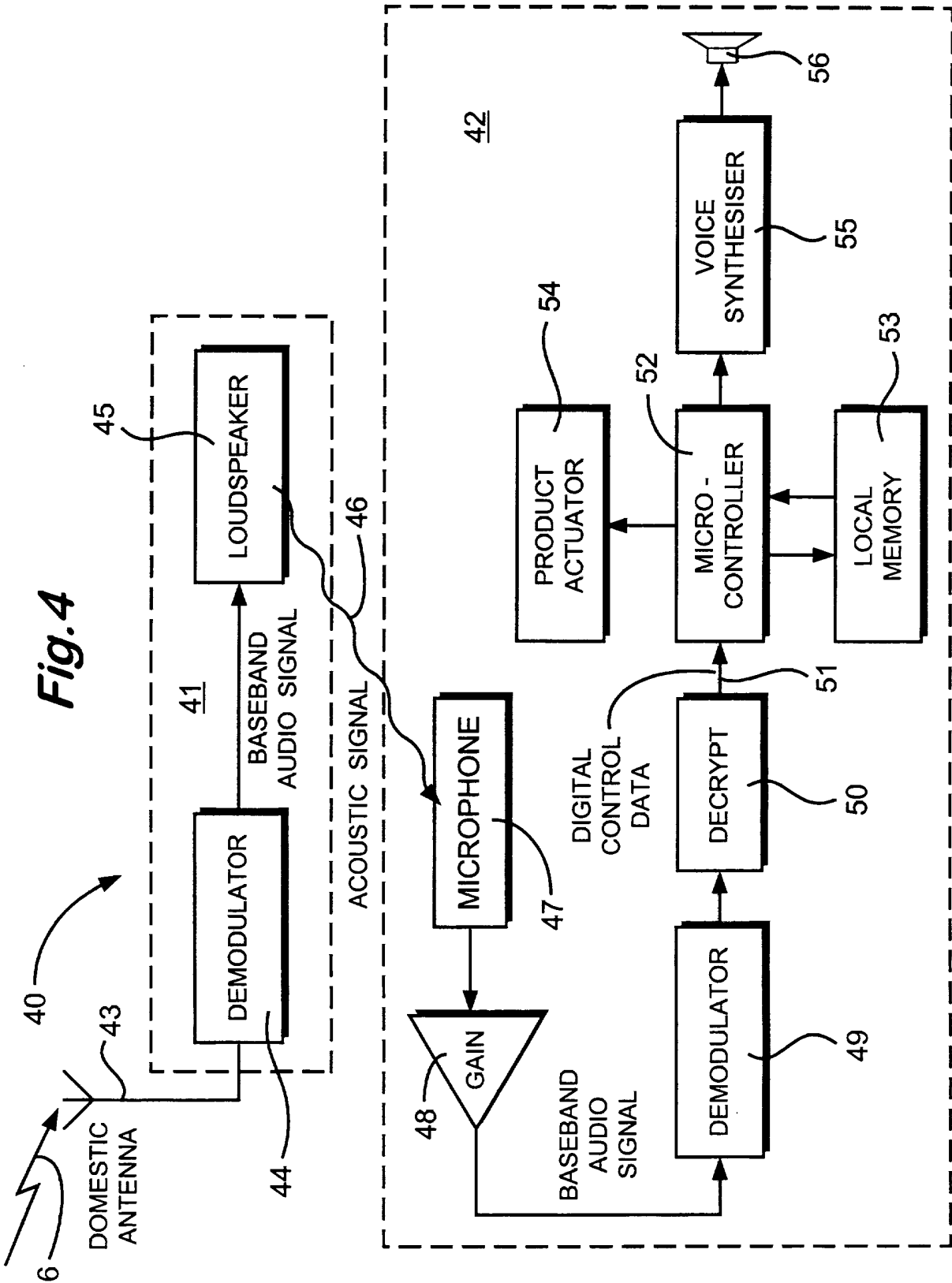
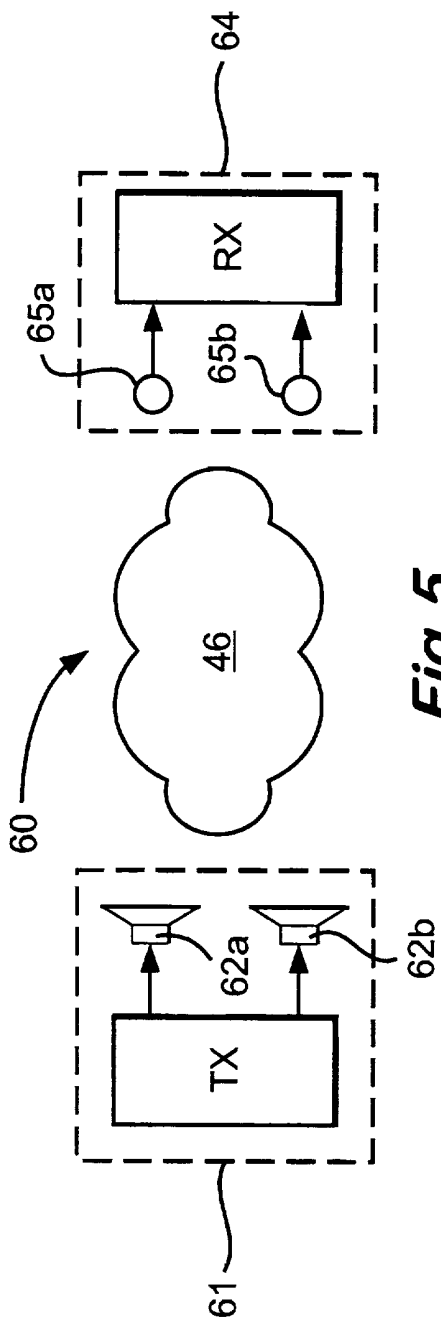

Fig. 3







**Fig. 5**

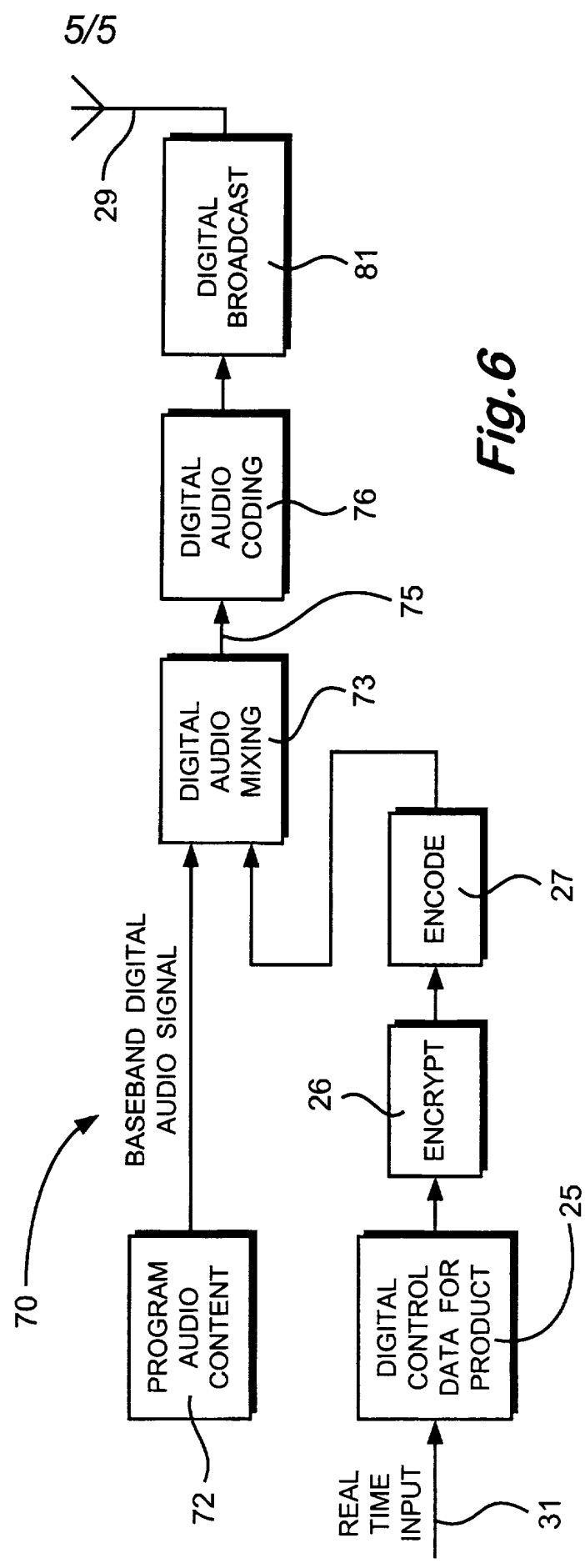

**Fig. 6**

## INTERACTIVE COMMUNICATIONS APPARATUS AND METHOD

The present invention relates to an interactive communications apparatus and method. More specifically, the present invention relates to an apparatus and a method for interacting with remote items such as toys and other novelty devices via an acoustic signal.

Presently toys can be pre-programmed to perform certain tasks in response to a predefined signal. This signal may be an electrical or acoustic signal, or a physical signal such as pressure. For example, a doll may cry when it is squeezed or dance in response to music being played.

However, these types of toys have a limited range of responses and are not readily re-programmable. Furthermore, these toys are not capable of interacting with signals, for example, from a television (TV) broadcast.

It is an object of the present invention to provide a toy which can respond to and interact with an acoustic signal from, for example, a TV broadcast. It is a further object of the present invention to enable the toy to be re-programmed by means of this acoustic signal.

According to the present invention there is provided apparatus for communicating with a remote item comprising means for transmitting data, means for receiving said transmitted data, means for embedding said received data into an acoustic signal, means for transmitting said acoustic signal, means for receiving said acoustic signal, and means for interpreting said data upon which control of said remote item may be modified.

Furthermore, according to the present invention there is provided a method for communicating with a remote item, said method comprising the steps

of transmitting data, receiving said transmitted data, embedding said received data into an acoustic signal, transmitting said acoustic signal, receiving said acoustic signal, and interpreting said data upon which operation of said remote item may be modified.

The remote item may be a toy.

Advantageously, the present invention requires no additional hardware to be attached to the receiver. Furthermore, the present invention works independent of the broadcast system.

Advantageously, the present invention can be used to reinforce educational or promotional messages.

While the principle advantages and features of the present invention have been described above, a greater understanding and appreciation of the present invention may be obtained by referring to the drawings and detailed description of the preferred embodiments, presented by way of example only, in which;

Figure 1 is a diagram of the basic system,

Figure 2 is a diagram of an analogue transmission system,

Figure 3 is a diagram of an alternative analogue transmission system including checking and real time input features,

Figure 4 is a diagram of an analogue broadcast receiver,

Figure 5 is a diagram of an alternative analogue broadcast receiver, and

Figure 6 is a diagram of a digital broadcast transmission system.

In Figure 1, the basic concept of the invention is shown, in which a child 1, for example, is shown watching a TV programme on monitor 2 while accompanied by a remote item, such as toy robot 4. Broadcast station 5 is arranged to transmit signal 6, which contains the TV programme that the child is watching. The TV program is received by and displayed on monitor 2. In



addition to an audio and visual component, signal 6 also includes a data burst which contains information for controlling toy robot 4. Toy robot 4 is configured so as to receive and interpret the control data upon which operation of the toy can be modified.

The toy robot can either be activated by a data burst at the beginning of the TV program or by following a data track embedded into the audio component of signal 6. Upon receipt of the data, toy robot 4 will appear to interact with the TV program. The data can cause the toy robot to move in a certain way or to speak. Alternatively, the data can be used to update the toy robot with new software. The new software can add or amend features, such as behaviour and vocabulary of the toy, all via the same data path.

In Figure 2 the basic transmission process 20 for an analogue broadcast system is shown. The term analogue broadcast system includes all PAL, NTSC and SECAM type broadcasts, FM and AM radio broadcast in HF, VHF and UHF bands, as well as analogue satellite and cable systems. The audio content 21 of a program to be broadcast is transmitted as part of the baseband audio signal. Digital control data 25 for controlling a remote item, such as the toy robot shown in Figure 1, is encrypted by encryption means 26. The control data may be encrypted using either an asymmetric or symmetric encryption scheme. The data is then modulated by modulation means 27 onto a carrier using, for example, angle modulation such as FSK, PSK, DPSK or CPSK, pulse position modulation, or multi-dimensional modulation schemes. The modulated data is then amplified by amplifier 28 and then combined with the audio content 21 of the program by summation means 23. The carrier can either be a simple tone or a spread spectrum carrier such as frequency hopped, chirped, or direct sequence spread spectrum. Broadcast means 24 then transmits a signal 6, which is the

combination of audio content 21 and digital control data 25, via broadcast antenna 29. As will be appreciated, broadcast means 24 may be a VHF or UHF television broadcast or an AM or FM radio broadcast.

In Figure 3, where parts also appearing in Figure 2 bear identical numerical references, shows a more sophisticated version of the analogue transmission system shown in Figure 2. Here analogue transmission system 30 comprises the additional features of the ability to add real time digital data 31 and a feedback path 32.

Real time digital data 31 is input to control data 25 before encryption 26, modulation 27, amplification 28, and summation 23 with the program audio content 21 occurs. The addition of a real time input feature allows for toy 4 to appear to interact with the broadcast appearing on monitor 2. As will be appreciated, the broadcast can be a live broadcast or a pre-recorded broadcast.

To support this real time input feature and to ensure adequate encoding and modulation of the all data, feedback path 32 is included in the analogue transmission system. Feedback path 32 comprises an acoustic model 32a of the environment in which toy 4 is located, demodulation means 32b and decryption means 32c to ensure that information can be adequately decoded after being combined with audio content 21, data comparing means 32d for comparing original control data with control data altered by the model, and adjustment means 32e for adjusting modulation means 27 and amplification means 28 to allow for the modulation scheme to compensate for the model dynamics.

Figure 4 shows a diagram of a receiving system 40 used for receiving signal 6 broadcast from the transmission systems shown in either of Figures 2 or 3 and for transforming signal 6 into an acoustic signal 46. Receiving system 40 comprises a domestic receiver 41 and a remote device receiver 42. The remote

device receiver 42 must be located proximate the source of acoustic signal 46, which can be located in the domestic receiver 41. The domestic receiver can part of a TV or a radio. The remote device receiver 42 must be located proximate the remote item to be controlled, which can be, for example, a toy such as toy robot 4.

Operation of the receiving system is as follows. Domestic receiver 41 receives signal 6 via domestic antenna 43, demodulates the audio component of signal 6 via demodulation means 44 and then generates an acoustic signal 46 via loudspeaker 45. The acoustic signal is received by microphone 47 located within device receiver 42. The acoustic signal is then amplified by amplification means 48 and demodulated by demodulation means 49, which functions to regenerate digital control data 25. The control data is then applied to decryption means 50 which in turn generates the intended control data 51 for use by the remote device. In Figure 4, the intended remote device is toy robot 4 and is controlled by microcontroller 52. Digital control data 51 is communicated to microcontroller 52 and used to update programs stored in local memory 53 of the toy robot. Alternatively, the digital control data is used to generate control signals for the toy robot's actuators 54 and/or voice synthesiser 55 which is connected to loudspeaker 58. Furthermore, if the toy robot contains a local feedback feature, a child playing with the robot can be requested to move the robot to an area in which there is improved reception of acoustic signal 46.

As will be appreciated, in order to maximise signal reception, various configurations of transmission and receiver system previously described can be utilised.

Figure 5 shows a stereo receiver system 60 in which the domestic receiver system 61 has two loudspeakers 62a, 62b for transmitting acoustic

signal 46 to a remote item's receiver system 64. The remote item's receiver system is configured with two microphones 65a, 65b for receiving the acoustic signal. In this embodiment all the sound channels are used to independently transmit digital control data 25, thus giving acoustic signal 46 spatial diversity and thereby reducing the probability that the remote device, such as the toy robot, is in a location in which acoustic signal 46 is not received. Furthermore, depending upon the size of the toy, the use of two or more microphones can add an extra degree of spatial diversity to the toy itself.

In a further embodiment, frequency and time diversity are used such that the same digital control data is transmitted at different times and/or at different carrier frequencies. This can be achieved using such techniques as spread spectrum and frequency-hopping schemes.

Figure 6 shows a digital broadcast transmission system 70 which transmits a program's audio content 72 and digital control data 25 over digital channels. The broadcast can be a DAB (Digital Audio Broadcast) or a DVB (Digital Video Broadcast). Similar to the analogue transmission system shown in Figure 3, digital transmission system 70 includes the feature of a real time digital data input means 31.

Digital transmission system 70 functions as follows. The audio content 72 of the program to be broadcast is generated in a digital format, such as AES3, and is combined in a digital mixer means 73 with the digital control data 25, which has already been encoded and encrypted as described in Figure 3. The resultant audio plus control data stream 75 is fed into digital audio encoder 76 and then combined with the video content of the program. The combined audio, video and control data stream is then encoded into the full digital data stream for channel encoding and transmission by digital broadcast means 81 via antenna 29.

As will be appreciated, the digital broadcast can use any one of a number of well known standards or their derivations, such as NICAM, MPEG2, or AC3. A multi-tone modulation scheme, such as FSK (frequency shift keying), can be used in the digital transmission system.

A digital receiver system for use with transmission system shown in Figure 6 may consist of a domestic digital receiver, such as a DAB, a digital satellite or terrestrial receiver, and the remote item itself. Advantageously, the present invention can be incorporated into a remote item such as a toy with little or no modifications necessary to the electronics within the toy. This is due to the fact the toy responds to actual acoustic signals.

Furthermore, in addition to digital and analogue broadcasts, the present invention applies to other forms of data broadcast, for example, Webcasting through the Internet using MPEG1 Layer 3 (MP3) or Microsoft wav files. Advantageously, the present invention will operate with audio CD (16bit PCM), CDROM, and DVD (AC3).

As will be appreciated, the data capacity of the broadcast channel is equal to the achievable data rate multiplied by the time available to transmit the data. Using relatively low amounts of transmitted data, such as four to eight bytes, the information can be used to trigger built-in responses, such as triggering a sequence of actions or phrases. As the amount of data increases to approximately ten one hundred bytes, the information can be used to modify the built-in responses, add new phrases or action sequences, or to download new data for field programmable devices and microcontrollers.

Furthermore, while encryption of the control data is not required, it does help to prevent misuse of the broadcast channel. The need for encryption becomes more critical as the amount of data transmitted to the device increases.

For example, triggering a pre-defined response would not require the same level of protection as a complete downloading of new data.

In a further embodiment of the present invention, a facility is provided for the broadcaster to restore factory settings by transmission of a reset code. Furthermore, a rest button could be included on the toy, which when pressed resets the toy to the factory settings.

As will be appreciated by those skilled in the art, various modifications may be made to the embodiment hereinbefore described without departing from the scope of the present invention.

## CLAIMS

1. Apparatus for communicating with a remote item comprising means for transmitting data, means for receiving said transmitted data, means for embedding said received data into an acoustic signal, means for transmitting said acoustic signal, means for receiving said acoustic signal, and means for interpreting said data upon which control of said remote item may be modified.
2. Apparatus as claimed in Claim 1, wherein said data is transmitted with an audio component of a program.
3. Apparatus as claimed in Claim 2, wherein said means for transmitting data includes means for inputting real time data.
4. Apparatus as claimed in any preceding Claim, wherein said means for transmitting data includes means for monitoring and adjusting said data prior to transmission.
5. Apparatus as claimed in any preceding claim, wherein said transmitted data is an analogue signal.
6. Apparatus as claimed in any of Claims 1-4, wherein said transmitted data is a digital signal.
7. Apparatus as claimed in any preceding claim, where said means transmitting a signal includes means for encrypting said data.
8. Apparatus as claimed in Claim 7, wherein said means for receiving said acoustic signal includes means for decrypting said data.
9. Apparatus as claimed in any preceding claim, wherein said means for receiving said transmitted data is a television.
10. Apparatus as claimed in any preceding claim, wherein said data reprograms said remote item.

11. Apparatus as claimed in any preceding claim, wherein said data includes a code which upon reception by said remote item resets said remote item to a predefined program.

12. Apparatus as claimed in any preceding claim, wherein said remote item includes means for resetting said remote item to a predefined program.

13. Apparatus as claimed in any preceding claim, wherein said remote item is a toy.

14. A method for communicating with a remote item, said method comprising the steps of:

transmitting data,

receiving said transmitted data,

embedding said received data into an acoustic signal,

transmitting said acoustic signal,

receiving said acoustic signal, and

interpreting said data upon which operation of said remote item may be modified.

15. A method as claimed in Claim 14, further comprising the step of encrypting said data prior to said step of transmitting data, and decrypting said data prior to said step of interpreting said data.

16. A method as claimed in Claims 14 or 15, wherein said data is transmitted with the audio component of a program.

17. Apparatus for communicating with a remote item as hereinbefore described with reference to the accompanying figures.





Application No: GB 9930647.4  
Claims searched: 1-17

Examiner: John Betts  
Date of search: 25 May 2000

**Patents Act 1977**  
**Search Report under Section 17**

**Databases searched:**

UK Patent Office collections, including GB, EP, WO & US patent specifications, in:

UK Cl (Ed.R): G4F (F14, F10X8, F10XX) H4F (FHT)

Int Cl (Ed.7): G08C 23/00 23/02 H04N 7/08, 7/085

Other: On-line: WPI, EPODOC, JAPIO

**Documents considered to be relevant:**

Category	Identity of document and relevant passage	Relevant to claims
A	GB2334133 A (Technovation Australia)	-
X	GB2192743 A (BBC) whole document	1, 14 at least
X	US4807031 (Interactive Systems) see whole document	1, 14 at least
X	(WO99/00979 A1 (Microsoft) whole doc but note page 14 lines 25-29	1, 14 at least

X Document indicating lack of novelty or inventive step  
Y Document indicating lack of inventive step if combined with one or more other documents of same category.  
& Member of the same patent family

A Document indicating technological background and/or state of the art.  
P Document published on or after the declared priority date but before the filing date of this invention.  
E Patent document published on or after, but with priority date earlier than, the filing date of this application.