



US00D596072S

(12) **United States Design Patent**
Yee

(10) **Patent No.:** **US D596,072 S**

(45) **Date of Patent:** **** Jul. 14, 2009**

(54) **TROPHY**

(75) Inventor: **Christopher Matthew Yee**, Morton Grove, IL (US)

(73) Assignee: **YG Commemorative**, Morton Grove, IL (US)

(**) Term: **14 Years**

(21) Appl. No.: **29/312,966**

(22) Filed: **Nov. 28, 2008**

(51) **LOC (9) Cl.** **11-02**

(52) **U.S. Cl.** **D11/131**

(58) **Field of Classification Search** D11/117-164;
428/542.2, 542.4, 542.6

See application file for complete search history.

(56) **References Cited**

U.S. PATENT DOCUMENTS

4,190,691	A	*	2/1980	Kramer	428/67
D260,747	S	*	9/1981	Malina	D11/131
5,698,334	A	*	12/1997	Berens	428/542.4
6,035,566	A	*	3/2000	Fisher	40/358
D427,546	S	*	7/2000	Tam	D11/164

D511,121	S	*	11/2005	Petree, Jr.	D11/164
D512,940	S	*	12/2005	Petree, Jr.	D11/131
D516,945	S	*	3/2006	Petree, Jr.	D11/131

* cited by examiner

Primary Examiner—Holly H Baynham

Assistant Examiner—Michelle E Wilson

(74) *Attorney, Agent, or Firm*—Justin Lampel

(57) **CLAIM**

The ornamental design for a trophy, as shown and described.

DESCRIPTION

FIG. 1 is a front plan view of a trophy;

FIG. 2 is a top view of the present invention;

FIG. 3 is a side view of the present invention;

FIG. 4 is a side view of the present invention;

FIG. 5 is a back view of the present invention; and,

FIG. 6 is a bottom view of the present invention.

The broken line showing is for illustrative purposes only and forms no part of the claimed design.

1 Claim, 2 Drawing Sheets

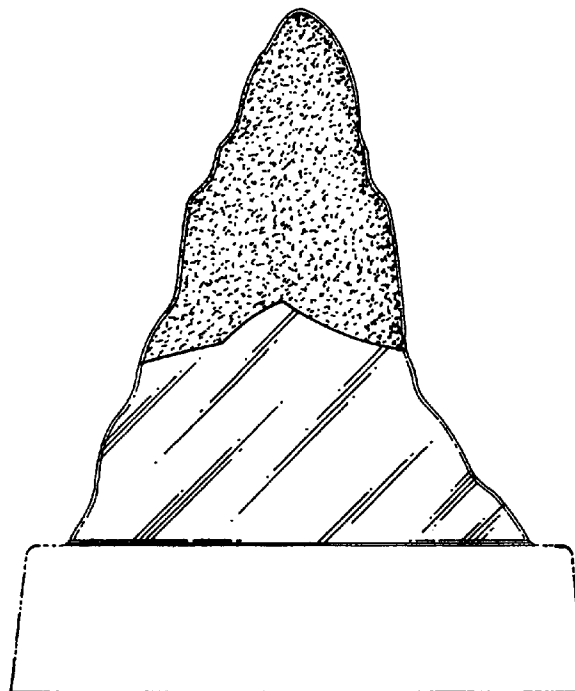
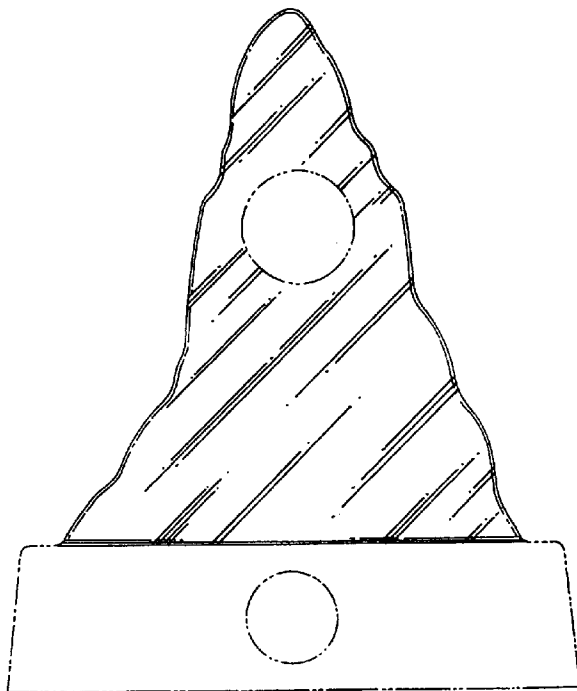

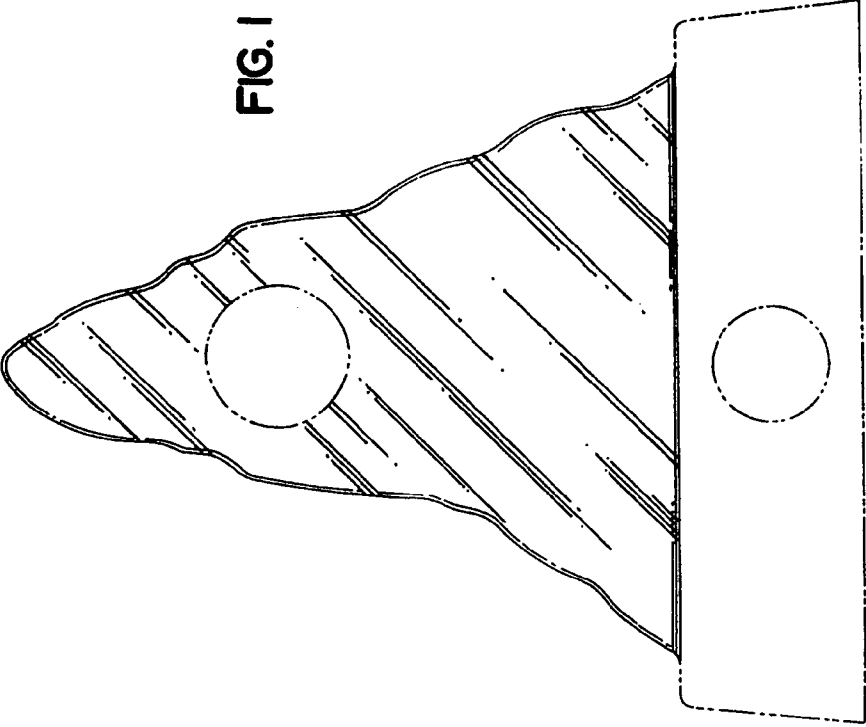
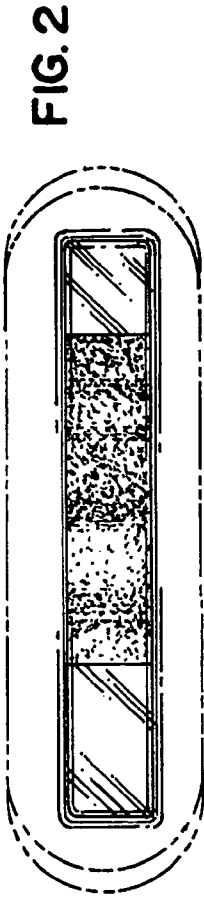

FIG. 4

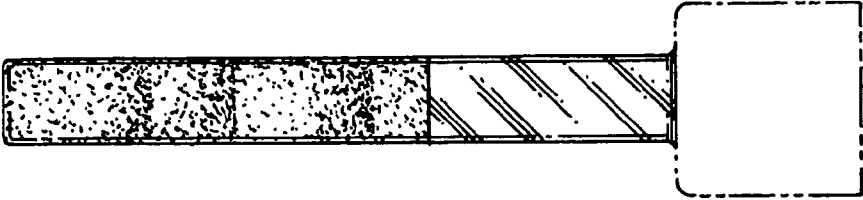

FIG. 3

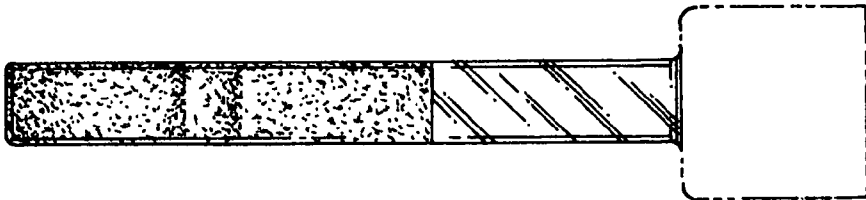

FIG. 5

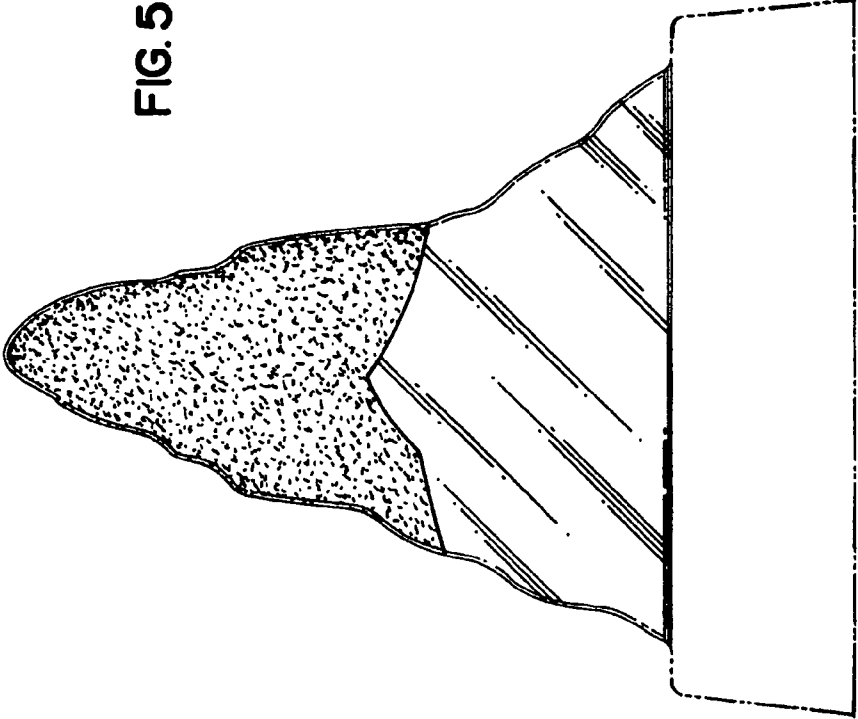

FIG. 6

