



US00D748841S

(12) **United States Design Patent**
Hiller

(10) **Patent No.:** **US D748,841 S**

(45) **Date of Patent:** **** Feb. 2, 2016**

(54) **LIGHT FIXTURE**

(71) Applicant: **Kason Industries, Inc.**, Newman, GA (US)

(72) Inventor: **Raymond J Hiller**, Newman, GA (US)

(73) Assignee: **Kason Industries, Inc.**, Newnan, GA (US)

(**) Term: **14 Years**

(21) Appl. No.: **29/507,911**

(22) Filed: **Oct. 31, 2014**

(51) **LOC (10) Cl.** **26-03**

(52) **U.S. Cl.**
USPC **D26/89**

(58) **Field of Classification Search**

USPC D26/72, 85, 89, 118, 120
CPC F21S 8/03; F21S 8/033; F21S 8/04;
F21V 3/04; F21V 3/0418; F21V 3/0427;
F21V 3/0436; F21V 3/0445; F21V 21/02;
F21V 21/03; F21V 29/506; F21V 3/049;
F21V 5/045; F21V 7/04; F21V 11/06
See application file for complete search history.

3,038,062 A	6/1962	Liberman
D212,899 S	12/1968	Vesely
D221,351 S	8/1971	Rmington
D225,370 S	12/1972	Peasley
D246,330 S	11/1977	Krase et al.
D248,503 S	7/1978	Grindle
D249,291 S	9/1978	Pemberton
D283,555 S	4/1986	Levi
D294,302 S	2/1988	Littrell et al.
D294,871 S	3/1988	Ewing et al.
D312,842 S	12/1990	Younger et al.
D336,863 S	6/1993	MacKenzie
D357,997 S	5/1995	Wegrzyn et al.
D378,438 S	3/1997	Sliney
D404,838 S	1/1999	Magnusson
D452,923 S	1/2002	Kim
D464,164 S	10/2002	Thompson
D477,891 S	7/2003	Fritze et al.
D496,487 S	9/2004	Rhee
D499,505 S	12/2004	Benensohn
D514,732 S	2/2006	Benensohn
D516,236 S *	2/2006	Yeh D26/89
D537,186 S	2/2007	Weddell

(Continued)

Primary Examiner — Clare E Hefflin

(57) **CLAIM**

The ornamental design for a light fixture, as shown and described.

DESCRIPTION

FIG. 1 is a perspective view of a light fixture showing my new design.
FIG. 2 is a left side view thereof.
FIG. 3 is a right side view thereof.
FIG. 4 is a front view thereof.
FIG. 5 is a rear view thereof.
FIG. 6 is a top view thereof; and,
FIG. 7 is a bottom view thereof.
The broken lines depict portions of the light fixture that form no part of the claimed design.

1 Claim, 4 Drawing Sheets

(56)

References Cited

U.S. PATENT DOCUMENTS

D47,153 S	3/1915	Franks
D47,607 S	7/1915	Owen
D73,078 S	3/1927	Graff
D74,818 S	4/1928	Biller
D91,888 S	4/1934	Kremer
D96,270 S	7/1935	Miller
D110,164 S	6/1938	Arenberg
D110,165 S	6/1938	Arenberg
2,149,635 A	3/1939	Shepard et al.
D158,917 S	6/1950	Wince
2,732,480 A	1/1956	Wells, II
D180,531 S	6/1957	Stevens et al.

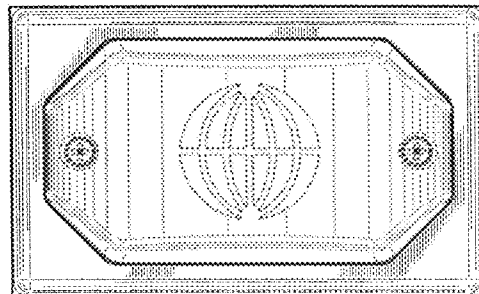
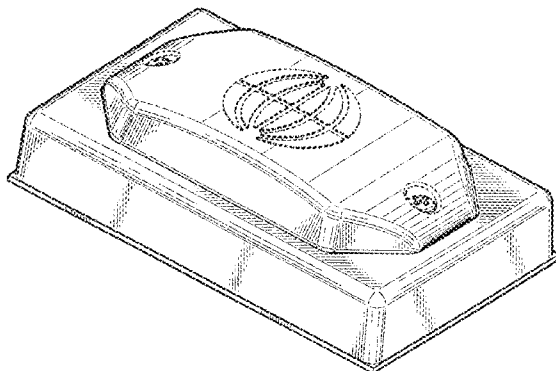

(56)

References Cited

U.S. PATENT DOCUMENTS

D547,484 S 7/2007 Guercio
D558,910 S 1/2008 Martineau
D561,925 S 2/2008 Levine
D567,989 S 4/2008 Goetz-Schaefer
D574,978 S 8/2008 Hyodo et al.
D586,028 S 2/2009 Condon et al.
D603,997 S 11/2009 Shiu
D616,593 S 5/2010 Jean
7,857,497 B2 12/2010 Koike et al.

D634,048 S 3/2011 Lombardi et al.
D634,055 S 3/2011 Hokazono et al.
D634,056 S 3/2011 Hokazono et al.
D637,339 S 5/2011 Hasan et al.
D649,673 S 11/2011 Liang et al.
D650,507 S 12/2011 Osiecki et al.
D690,853 S 10/2013 Huang
D696,809 S 12/2013 Zhang et al.
D728,147 S * 4/2015 Grewe D26/89
D728,149 S * 4/2015 Hiller D26/89
D728,150 S * 4/2015 Hiller D26/89
D728,151 S * 4/2015 Hiller D26/89

* cited by examiner

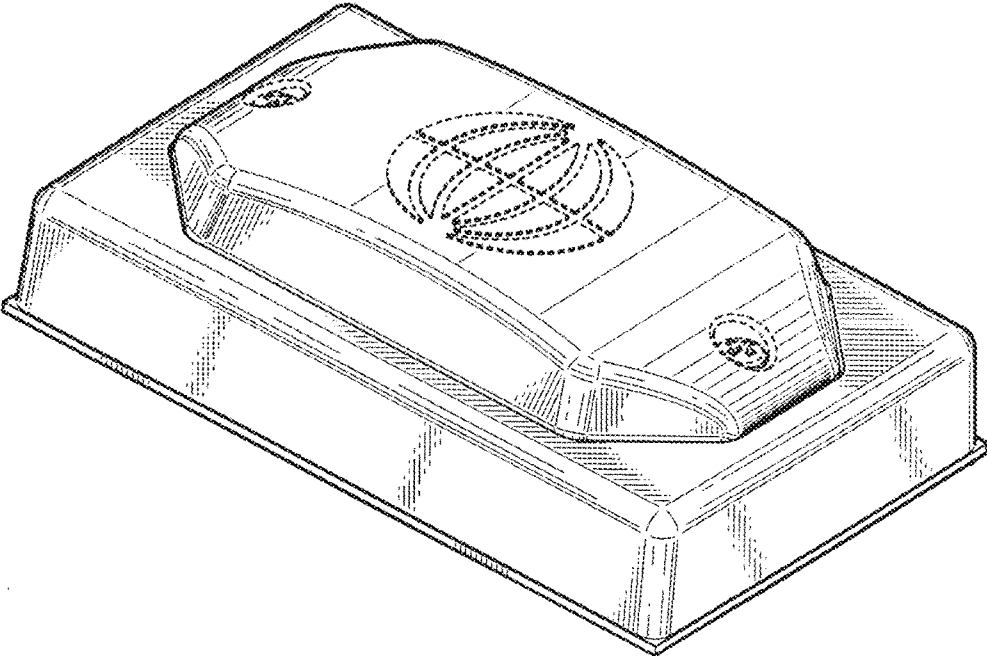

FIG. 1

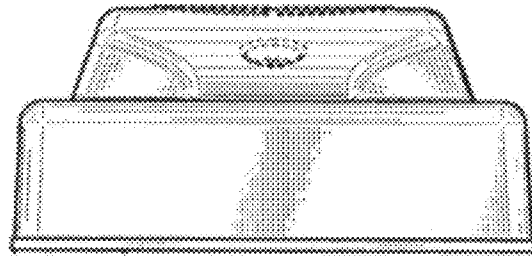

FIG. 2

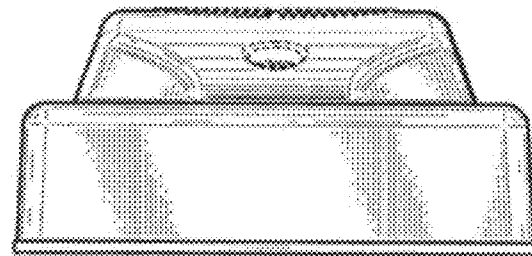

FIG. 3

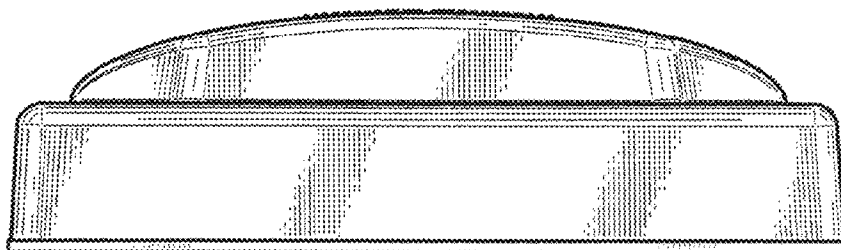

FIG. 4

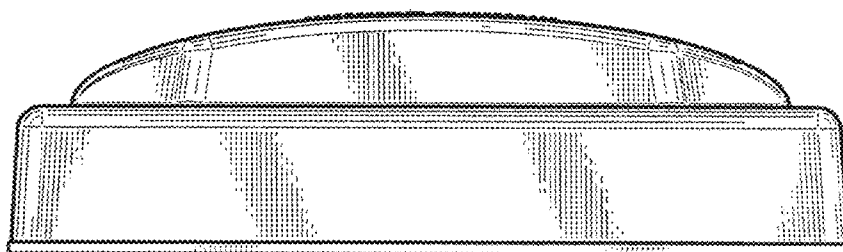

FIG. 5

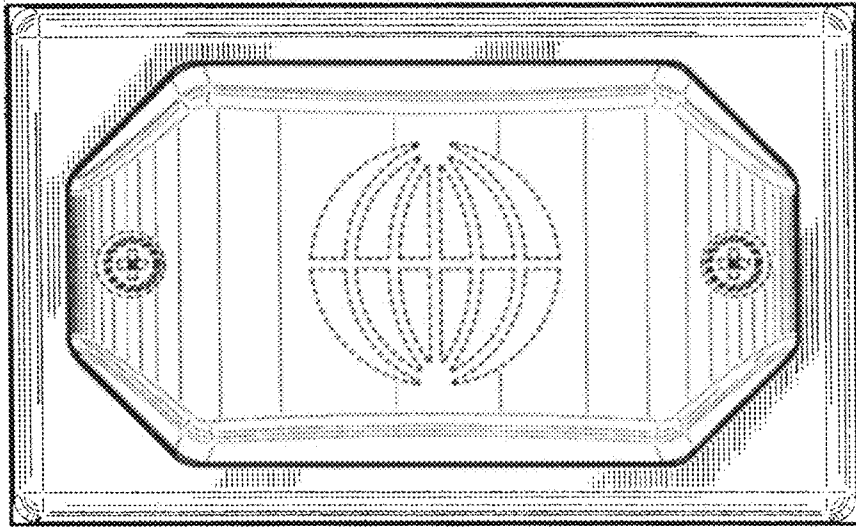

FIG. 6

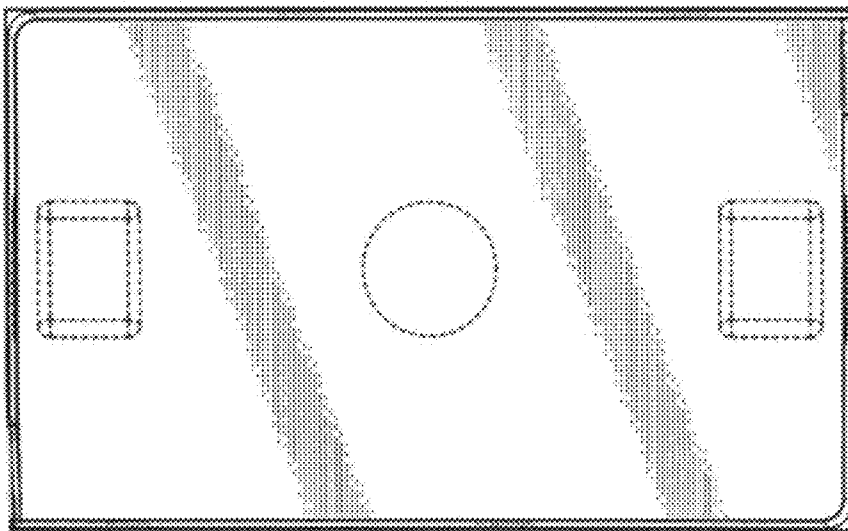

FIG. 7