

US00D549211S

(12) **United States Design Patent**
Oas

(10) **Patent No.:** **US D549,211 S**

(45) **Date of Patent:** **** Aug. 21, 2007**

(54) **VISOR VOICE RECORDER**

(76) Inventor: **Daniel Oas**, 6250 N. Irwindale Ave.,
Irwindale, CA (US) 91702

(**) Term: **14 Years**

(21) Appl. No.: **29/268,629**

(22) Filed: **Nov. 8, 2006**

(51) **LOC (8) Cl.** **14-01**

(52) **U.S. Cl.** **D14/167**

(58) **Field of Classification Search** D14/167,
D14/154, 168, 188, 496, 156, 240, 160, 243,
D14/161, 162, 164, 163, 165, 192; D13/168;
D10/70; D16/135, 208; D26/38; D3/266,
D3/265; 455/351, 350, 575.2

See application file for complete search history.

(56) **References Cited**

U.S. PATENT DOCUMENTS

D379,009 S *	4/1997	Osiecki	D14/167
D381,662 S *	7/1997	Weissberg et al.	D14/218
D437,113 S *	2/2001	Koehler	D3/219
D438,002 S *	2/2001	Lin	D3/265
D448,563 S *	10/2001	Kim	D3/266
D456,606 S *	5/2002	Kim	D3/266
D478,576 S *	8/2003	Leong	D14/240
D490,787 S *	6/2004	Aisenberg	D14/138
D495,665 S *	9/2004	Stekelenburg	D13/168
D497,601 S *	10/2004	Brandis	D14/138
D509,356 S *	9/2005	Kushner	D3/266

D525,151 S *	7/2006	Oas	D10/40
D525,241 S *	7/2006	Dyer	D14/243
D526,966 S *	8/2006	Chen	D13/168
D529,448 S *	10/2006	de Melo et al.	D13/168
D529,827 S *	10/2006	Komulainen	D10/70
D541,324 S *	4/2007	Yip et al.	D16/135
2003/0027606 A1 *	2/2003	Tsai	455/568

* cited by examiner

Primary Examiner—Cathron C. Brooks

Assistant Examiner—Austin Murphy

(74) *Attorney, Agent, or Firm*—Edgar W. Averill, Jr.;
Kenneth L. Green

(57) **CLAIM**

The ornamental design for a visor voice recorder, as shown.

DESCRIPTION

FIG. 1 is a perspective view showing the front, right side and bottom of the sun visor voice recorder showing my new design.

FIG. 2 is a front view thereof.

FIG. 3 is a right side view thereof.

FIG. 4 is a left side view thereof.

FIG. 5 is a back view thereof.

FIG. 6 is a top view thereof; and,

FIG. 7 is a bottom view thereof.

1 Claim, 2 Drawing Sheets

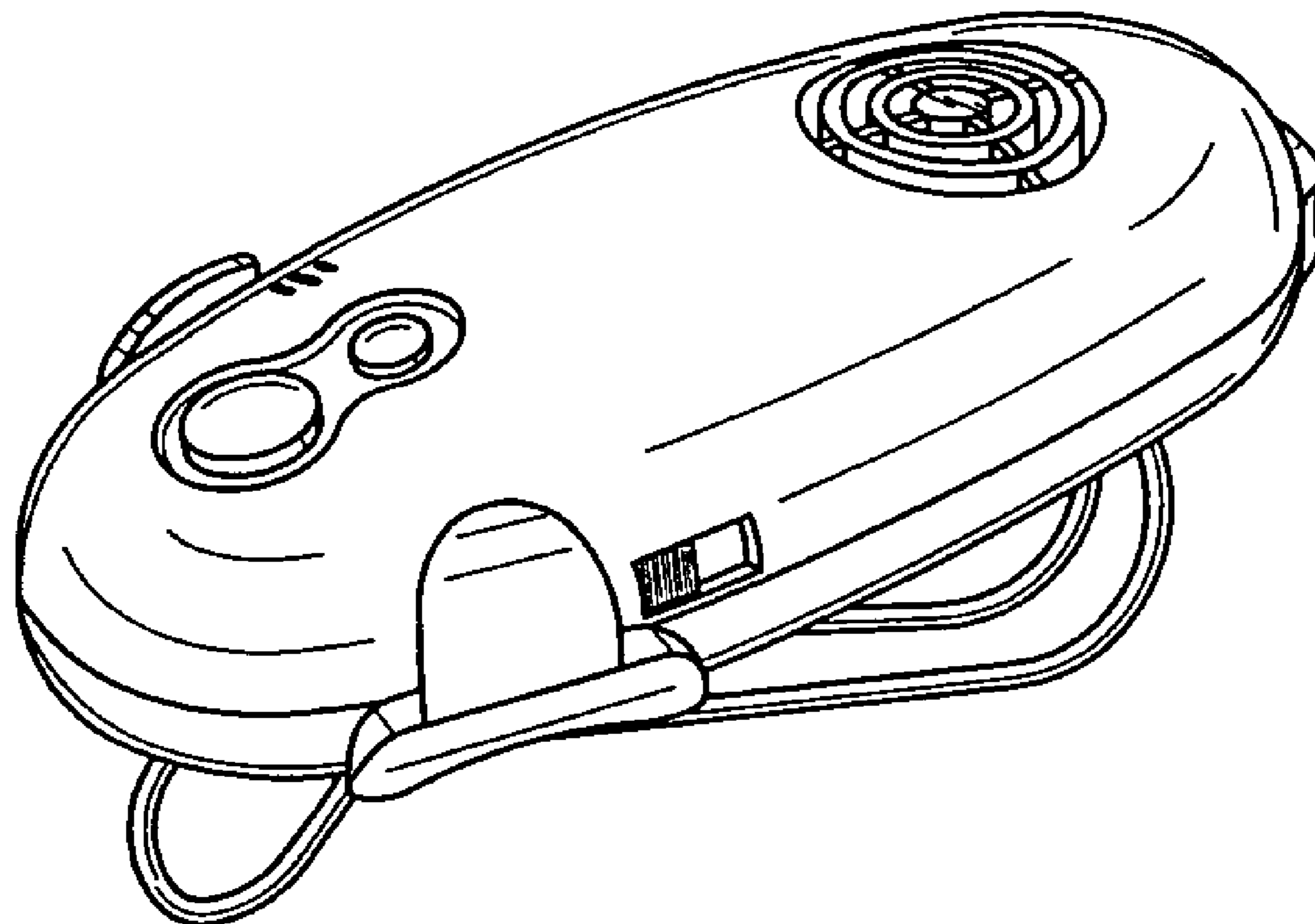

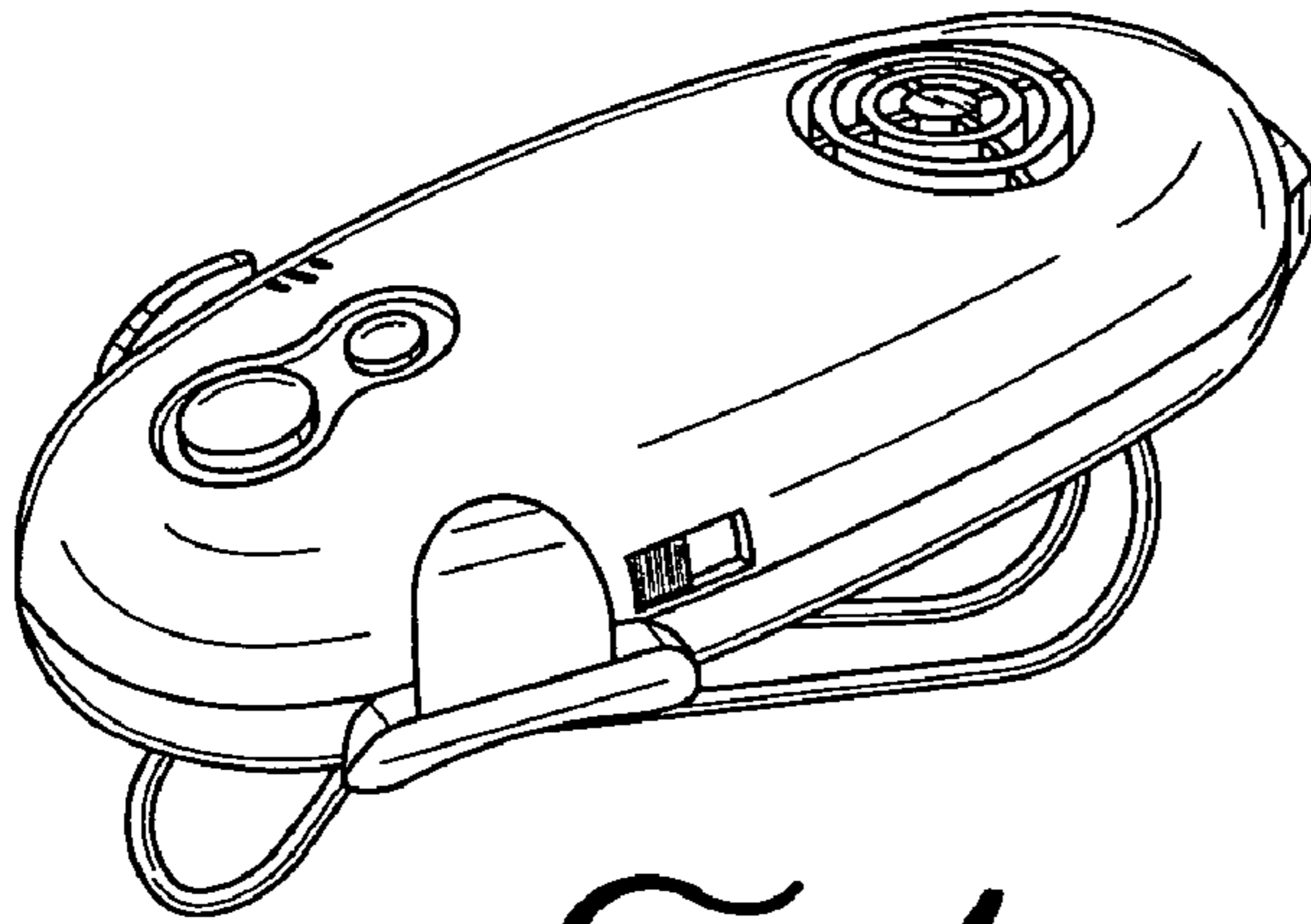

FIG. 1

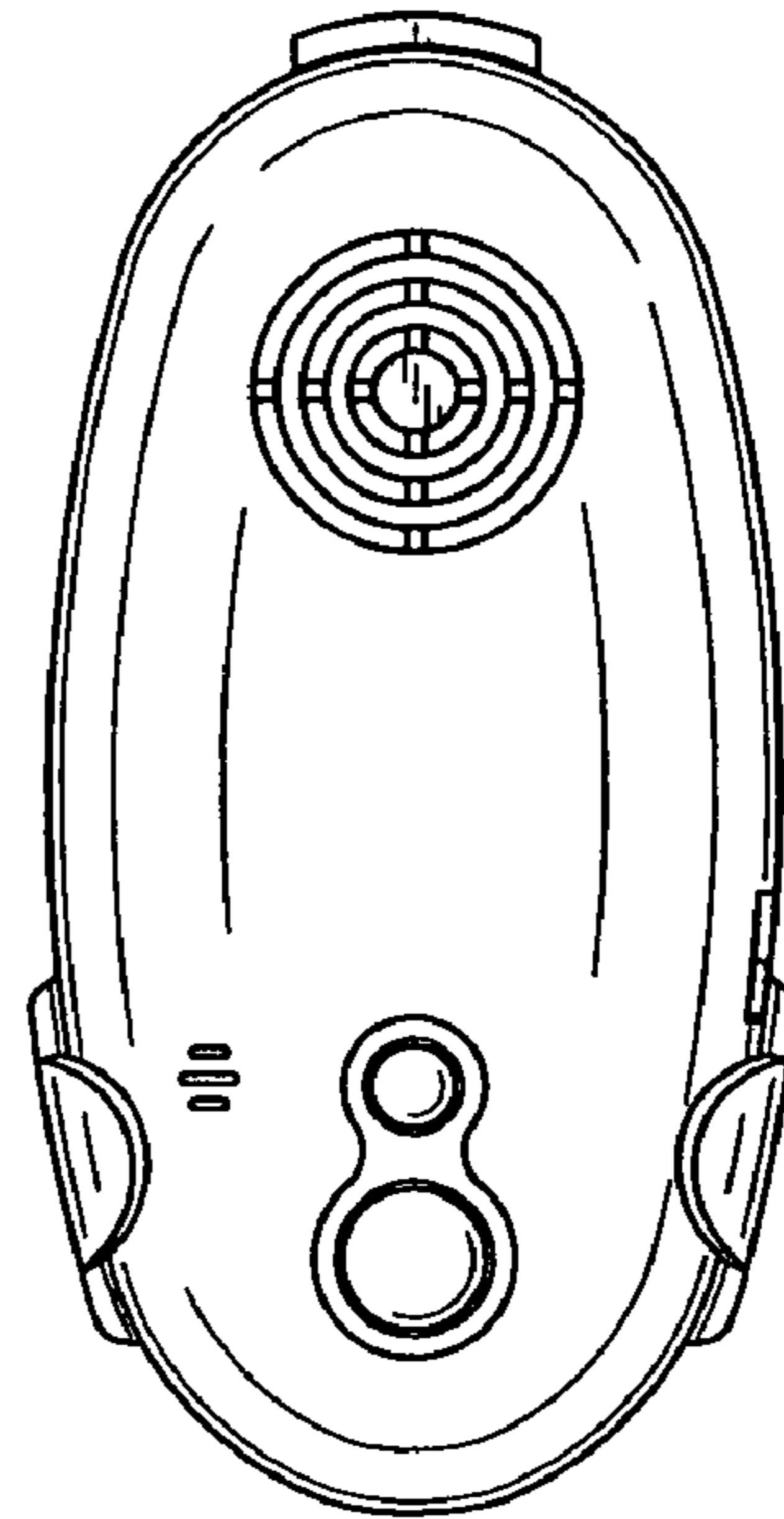

FIG. 2

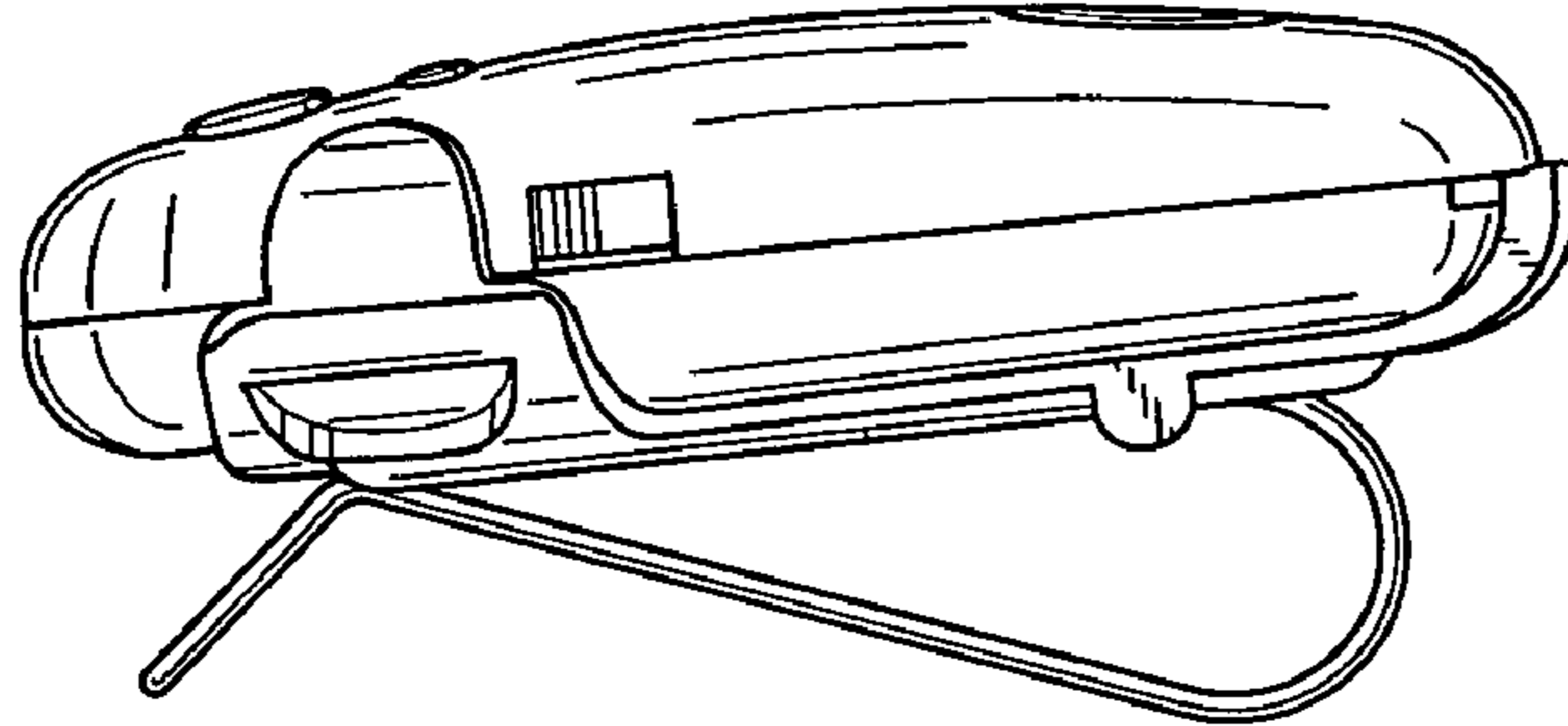

FIG. 3

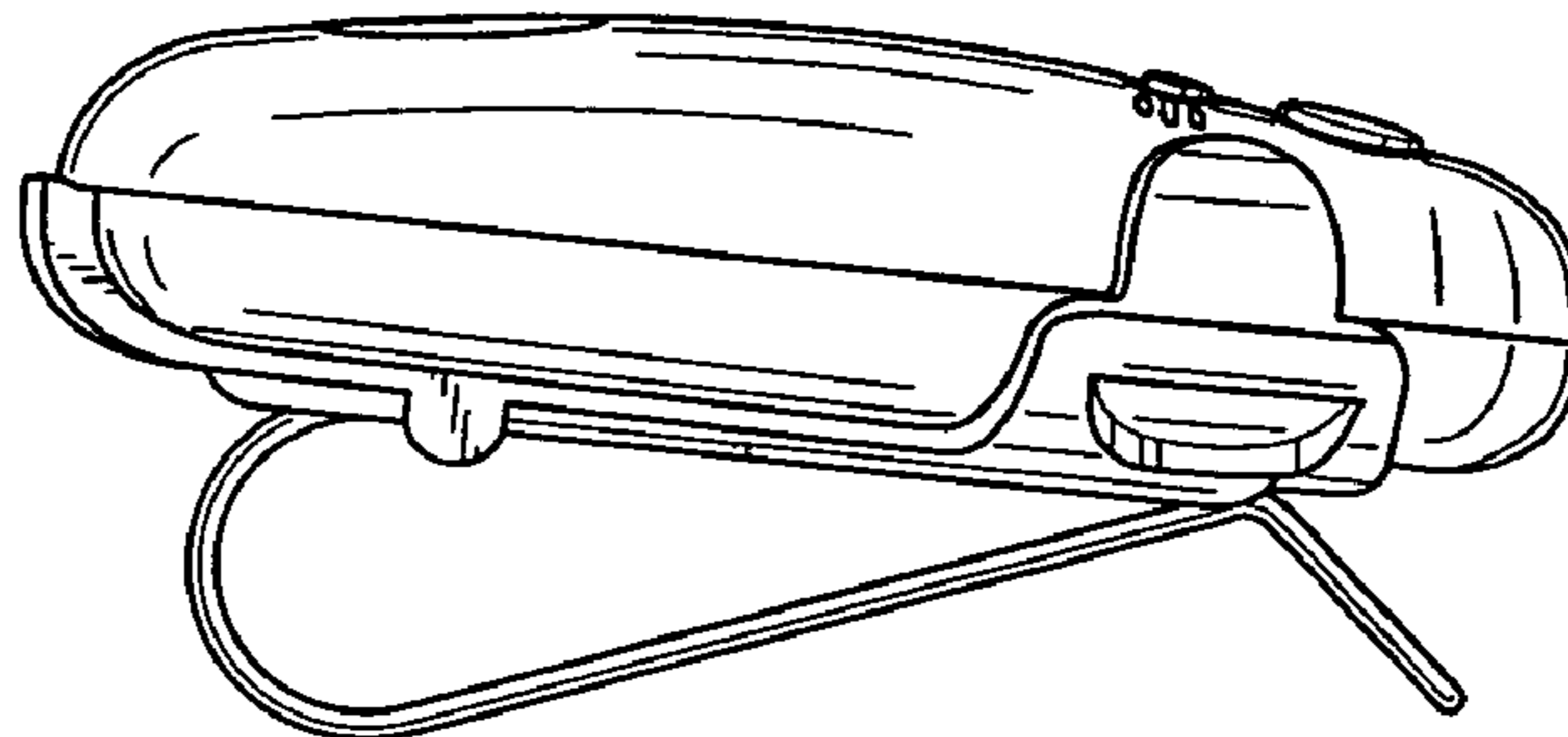

FIG. 4

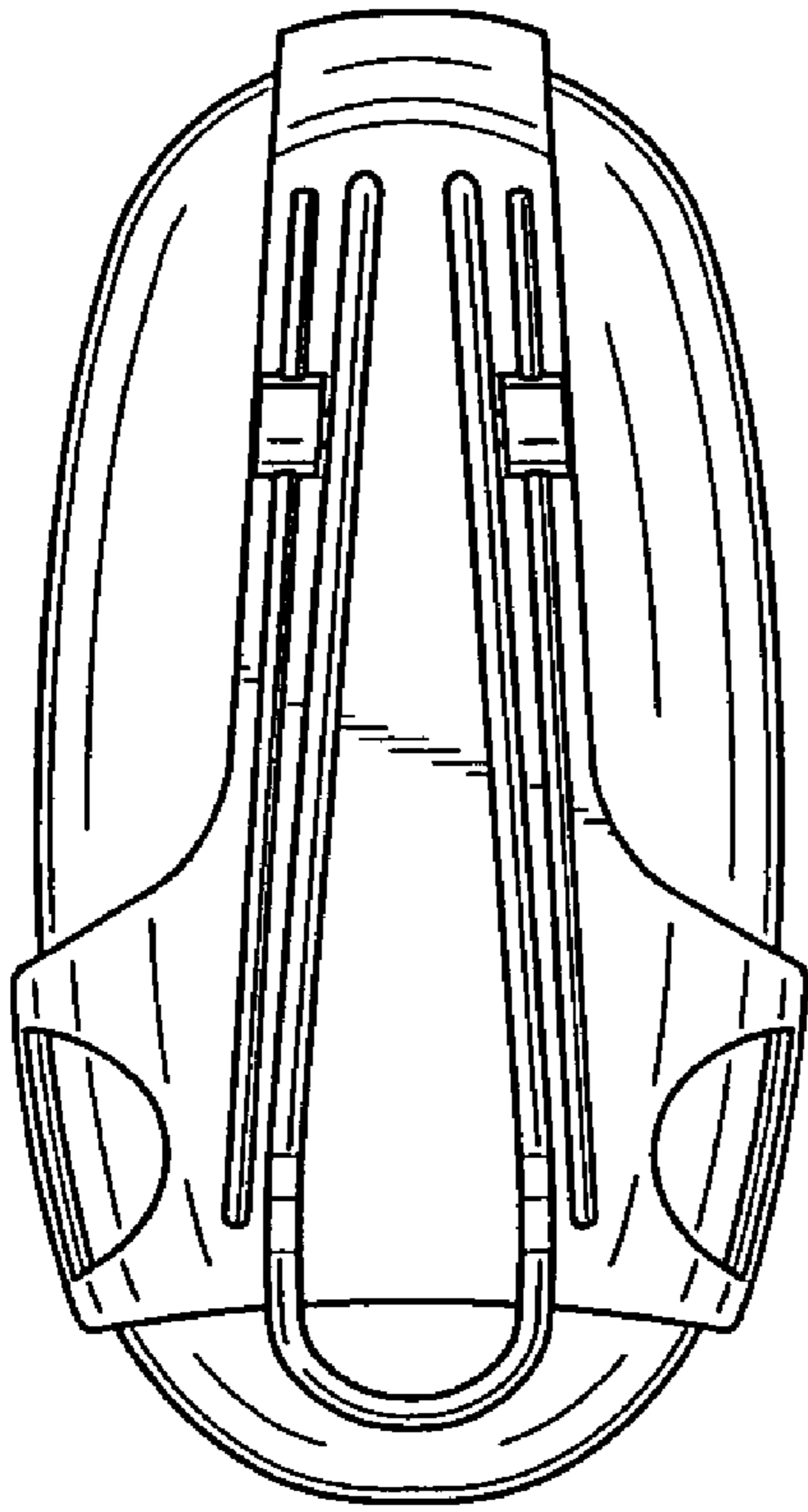

FIG. 5

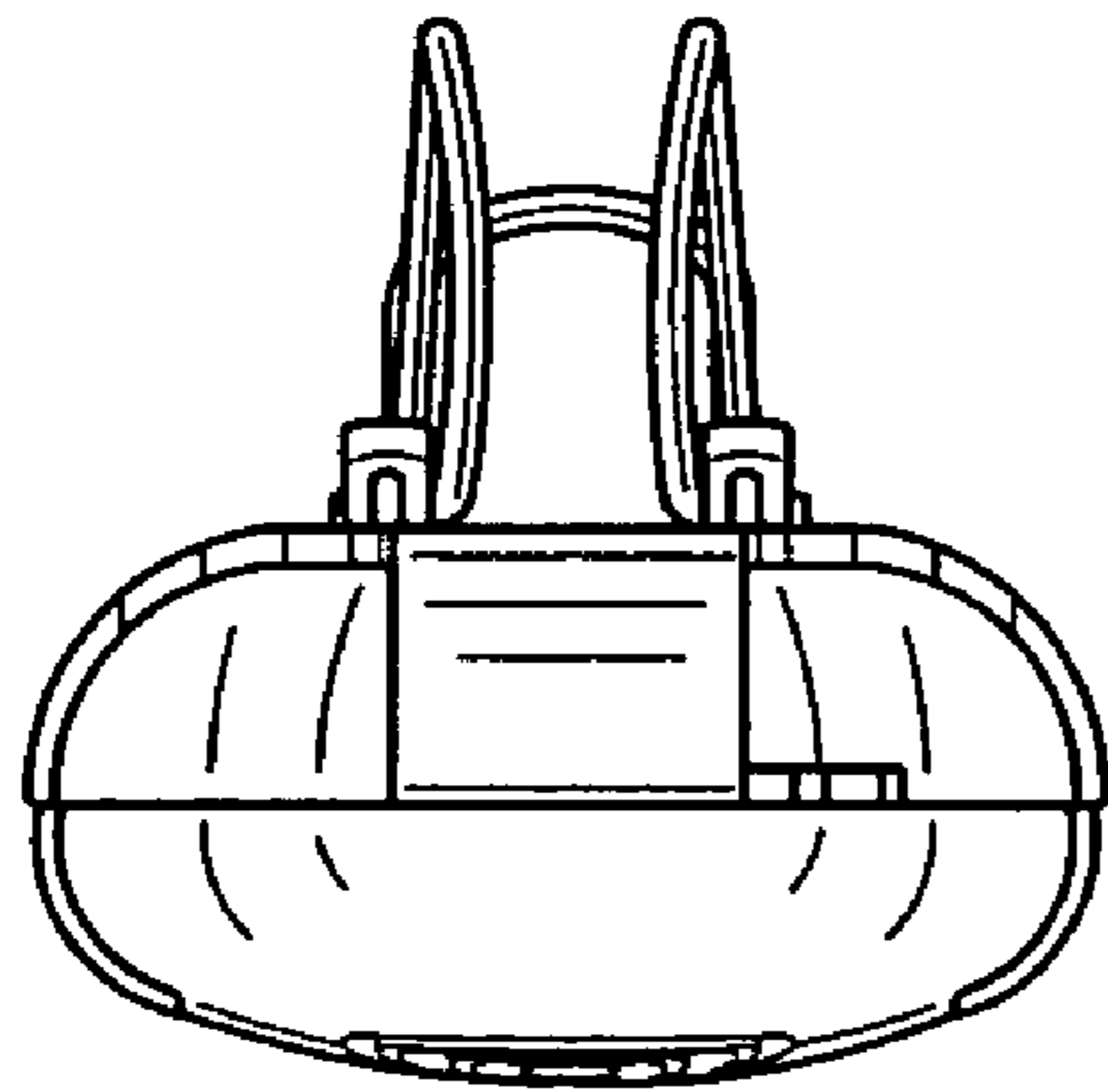

FIG. 6

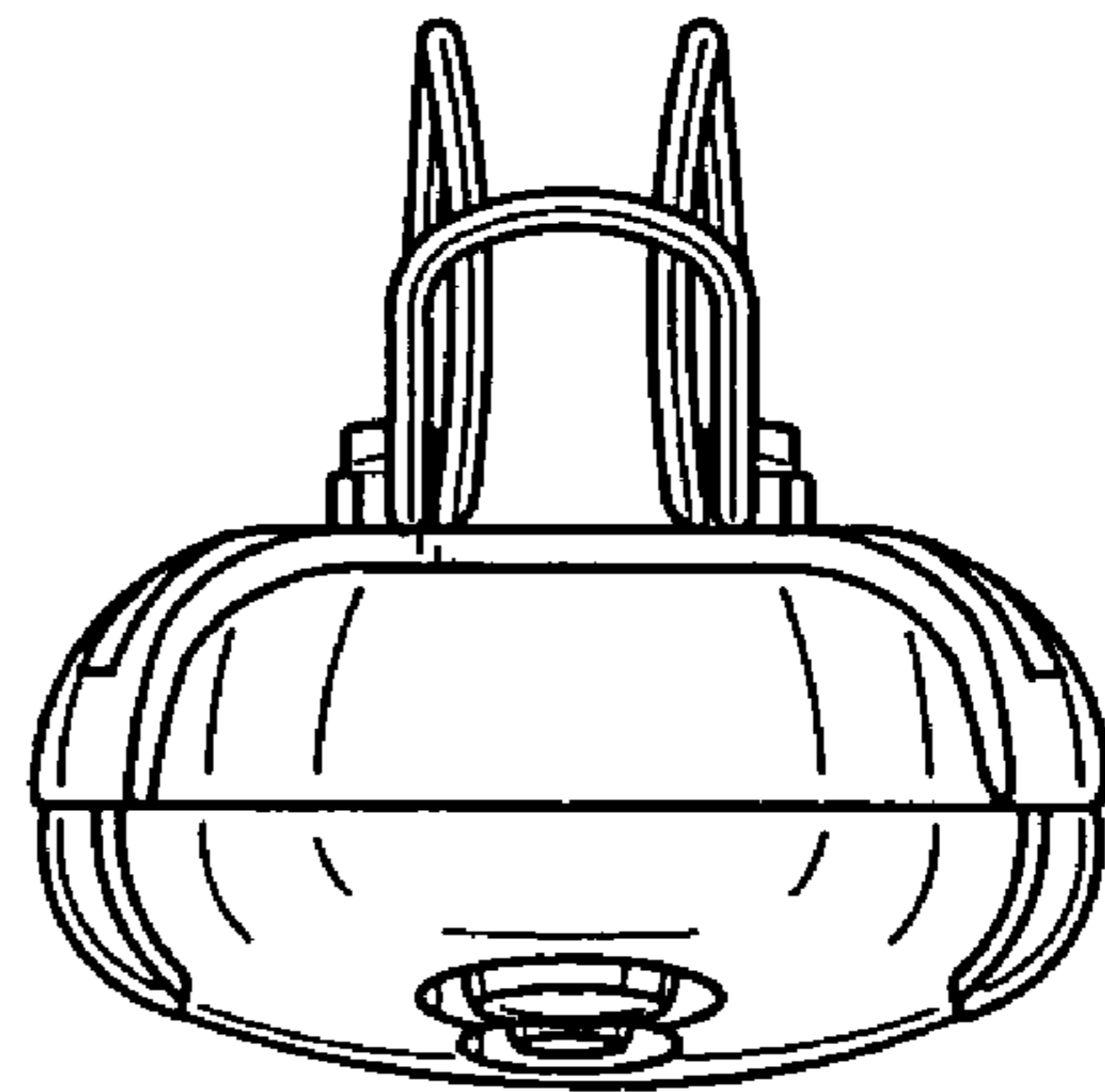

FIG. 7