



 **EUROPEAN PATENT APPLICATION**

 Application number: **83302305.4**

 Int. Cl.³: **A 63 F 3/02**

 Date of filing: **22.04.83**

 Priority: **22.04.82 GB 8211617**

 Applicant: **Basevi, John Licinio, 9, Dular Apartments 3637, South Olive, West Palm Beach Florida 33405 (US)**

 Date of publication of application: **02.11.83**
Bulletin 83/44

 Inventor: **Basevi, John Licinio, 9, Dular Apartments 3637, South Olive, West Palm Beach Florida 33405 (US)**

 Designated Contracting States: **AT BE CH DE FR GB IT LI LU NL SE**

 Date of deferred publication of search report: **25.04.84 Bulletin 84/17**

 Representative: **Walter, Douglas Ernest et al, HASELTINE LAKE & CO. 28, Southampton Buildings, London WC2A 1AT (GB)**

 **Instructional chess game.**

 An instructional chess game comprises a square playing board (1) of laminated construction having sixty-four individual playing squares (2) each of which is formed centrally with a substantially square opening surrounded by a corresponding «black» or «white» liner (4), the upper layer (3) of the board (1) preferably being of natural wood. The base (26, 38) of each of at least some of a conventional number of playing pieces will not fit any lined opening of the board (1) if said piece is facing in a direction that is not allowed by the traditional rules of chess and each playing piece (23, 28) is animated in such a way that, upon manipulation of its head (17), a spring loaded arm member (20) will cause a weapon (24) to strike a neighbouring and opposing playing piece or such manipulation will cause a projectile (31) to be fired by the sudden release of a spring-loaded and pivotted lever (34) after movement thereof to a cocked or firing position by a progressive displacement and sudden release cam (33). A video chess game is also described during which a substantially conventional chess board is visually represented and similarly represented playing pieces are shown to attack one another by striking each other or by launching projectiles, laser beams or the like at one another, the attacked and visually represented playing pieces collapsing/disintegrating before finally vanishing and being replaced by the attacking playing pieces with suitable sound effects.

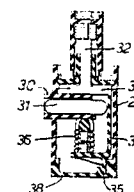
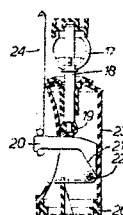
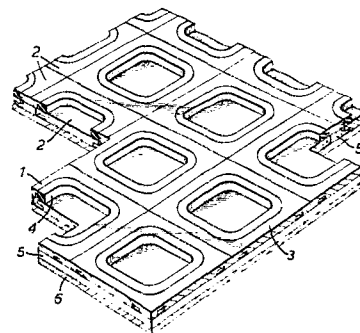



DOCUMENTS CONSIDERED TO BE RELEVANT			
Category	Citation of document with indication, where appropriate, of relevant passages	Relevant to claim	CLASSIFICATION OF THE APPLICATION (Int. Cl. ³)
A	<u>GB - A - 1 276 868</u> (MATHERS)		A 63 F 3/02
A	<u>DE - C - 472 387</u> (TRAPP)		
A	<u>US - A - 3 608 904</u> (MARGETSON)		
A	<u>US - A - 3 856 309</u> (HELFGOTT)		
A	<u>US - A - 3 843 133</u> (BROWN)		
A	<u>US - A - 3 746 343</u> (SHAPIRO)		
A	<u>DE - C - 912 196</u> (REICHE)		
A, D	<u>US - A - 3 627 324</u> (KREPP)		
A, D	<u>GB - A - 1 299 619</u> (MANDAK)		

			TECHNICAL FIELDS SEARCHED (Int. Cl. ³)
			A 63 F
The present search report has been drawn up for all claims			
Place of search The Hague		Date of completion of the search 31-10-1983	Examiner KNAUER
CATEGORY OF CITED DOCUMENTS		T : theory or principle underlying the invention E : earlier patent document, but published on, or after the filing date D : document cited in the application L : document cited for other reasons ----- & : member of the same patent family, corresponding document	
X : particularly relevant if taken alone Y : particularly relevant if combined with another document of the same category A : technological background O : non-written disclosure P : intermediate document			



CLAIMS INCURRING FEES

The present European patent application comprised at the time of filing more than ten claims.

- All claims fees have been paid within the prescribed time limit. The present European search report has been drawn up for all claims.
- Only part of the claims fees have been paid within the prescribed time limit. The present European search report has been drawn up for the first ten claims and for those claims for which claims fees have been paid, namely claims:
- No claims fees have been paid within the prescribed time limit. The present European search report has been drawn up for the first ten claims.

LACK OF UNITY OF INVENTION

The Search Division considers that the present European patent application does not comply with the requirement of unity of invention and relates to several inventions or groups of inventions, namely:

1. Claims 1-9: Chesset comprising animated pieces
2. Claim 10: Video Chess game.

- All further search fees have been paid within the fixed time limit. The present European search report has been drawn up for all claims.
- Only part of the further search fees have been paid within the fixed time limit. The present European search report has been drawn up for those parts of the European patent application which relate to the inventions in respect of which search fees have been paid, namely claims:
- None of the further search fees has been paid within the fixed time limit. The present European search report has been drawn up for those parts of the European patent application which relate to the invention first mentioned in the claims, namely claims: 1-9.