



US00D409016S

United States Patent [19]

[11] Patent Number: **Des. 409,016**

Haley et al.

[45] Date of Patent: **** May 4, 1999**

[54] **MOBILE WORKBENCH**

[75] Inventors: **Vincent L. Haley**, Orrville; **David A. Houk, Jr.**, Norton, both of Ohio

[73] Assignee: **Rubbermaid Incorporated**, Wooster, Ohio

[**] Term: **14 Years**

[21] Appl. No.: **29/070,044**

[22] Filed: **Apr. 25, 1997**

[51] **LOC (6) Cl.** **06-04**

[52] **U.S. Cl.** **D6/400**

[58] **Field of Search** D6/396, 400; D34/19, D34/20, 21, 22, 24, 25; D3/201, 905; 312/250, 257, 283, 319, 333, 902; 280/79.11, 79.2

[56] **References Cited**

U.S. PATENT DOCUMENTS

D. 230,801	3/1974	Hickman	D6/179
D. 250,079	10/1978	Hickman et al.	D6/178
D. 251,167	2/1979	Isles	D6/177
D. 254,281	2/1980	Kayfes	D6/436
D. 325,800	4/1992	Kelley	D34/19
D. 330,301	10/1992	Ugalde	D6/474
D. 361,216	8/1995	Lewellen et al.	D6/400
D. 361,910	9/1995	Maple et al.	D6/445
D. 367,537	2/1996	Calmeise et al.	D25/62
3,615,087	10/1971	Hickman	269/244
4,034,684	7/1977	Carson et al.	108/127
4,154,435	5/1979	Alessio	269/139
4,155,386	5/1979	Alessio	144/286 R
4,157,174	6/1979	Hickman	269/139
4,252,304	2/1981	Pettican	269/139
4,256,294	3/1981	Hickman et al.	269/16
4,364,549	12/1982	Eccardt	269/139
4,415,149	11/1983	Rees	269/88

4,442,779	4/1984	Basten et al.	108/131
4,757,849	7/1988	Morrison	144/287
4,880,221	11/1989	Richards	269/139
4,909,491	3/1990	Cheng	269/16
5,351,730	10/1994	Lewellen et al.	144/286 R

OTHER PUBLICATIONS

Catalog page, Portable workbenches; Waterloo Industries, 300 Ansborough Avenue, Waterloo, Iowa 50704. Publication date 1990.

P. 5, Portable workbenches; Harbor Freight, address unknown. Publication date 1992.

Primary Examiner—Carmen H. Vales-Lado
Attorney, Agent, or Firm—Richard B. O’Planick; Timothy B. Nathan

[57] **CLAIM**

The ornamental design for a portable mobile workbench, as shown and described.

DESCRIPTION

FIG. 1 is a top left front perspective view of a mobile workbench showing our new design; FIG. 2 is a front elevational view thereof; the rear elevational view being a mirror image; FIG. 3 is a left side elevational view thereof; FIG. 4 is a top plan view thereof; FIG. 5 is a right side elevational view thereof; FIG. 6 is a bottom plan view thereof; FIG. 7 is a top left perspective view with the broken lines removed for convenience of illustration; FIG. 8 is a left side elevational view thereof; and, FIG. 9 is a bottom plan view thereof. The broken lines shown in FIGS. 1 through 3, and 6 are for illustrative purposes only and form no part of the claimed design.

1 Claim, 9 Drawing Sheets

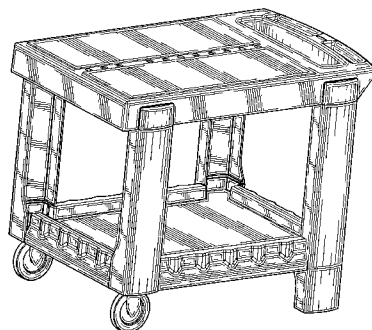
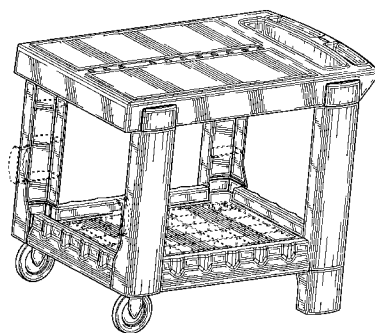

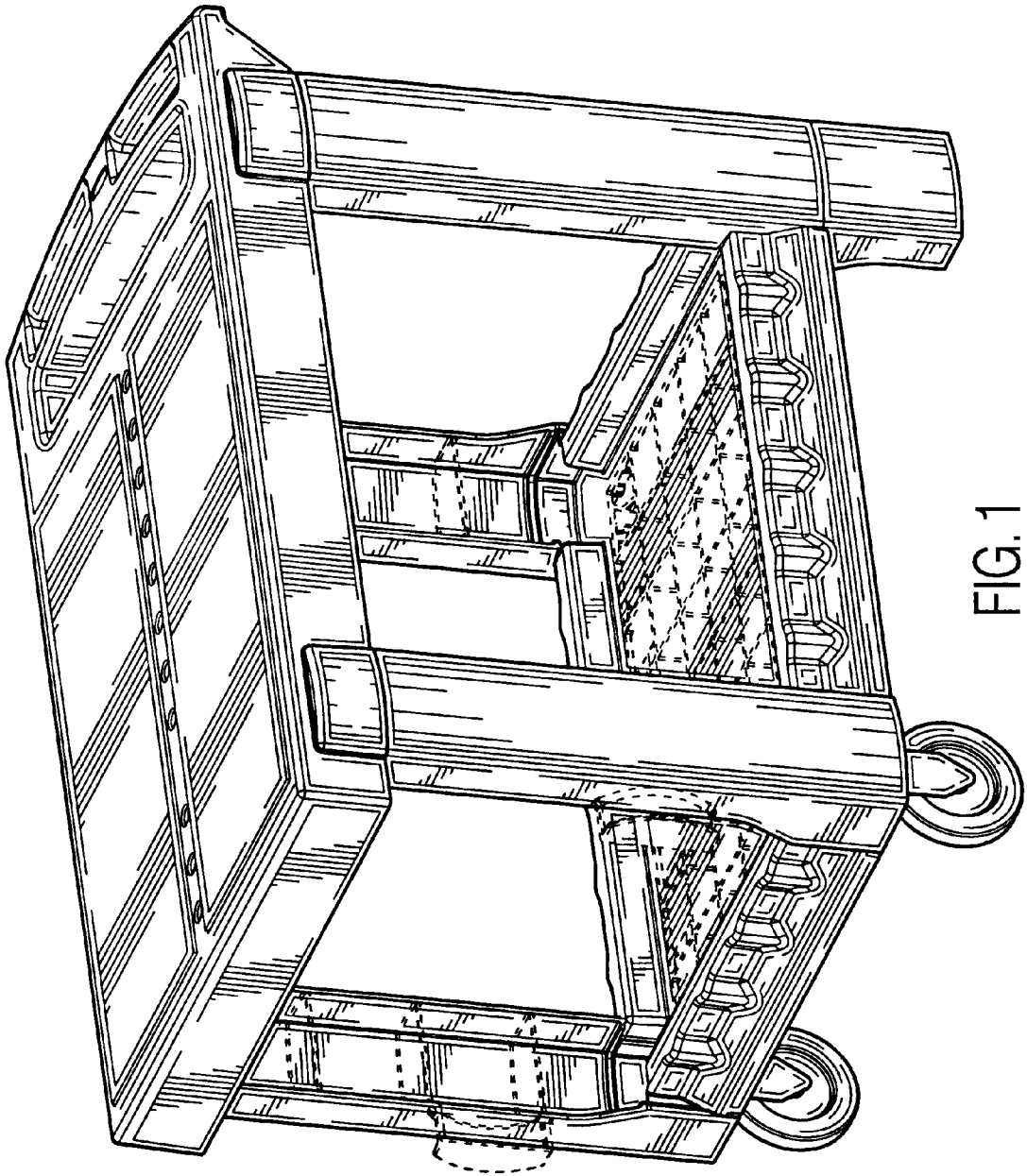

FIG. 1

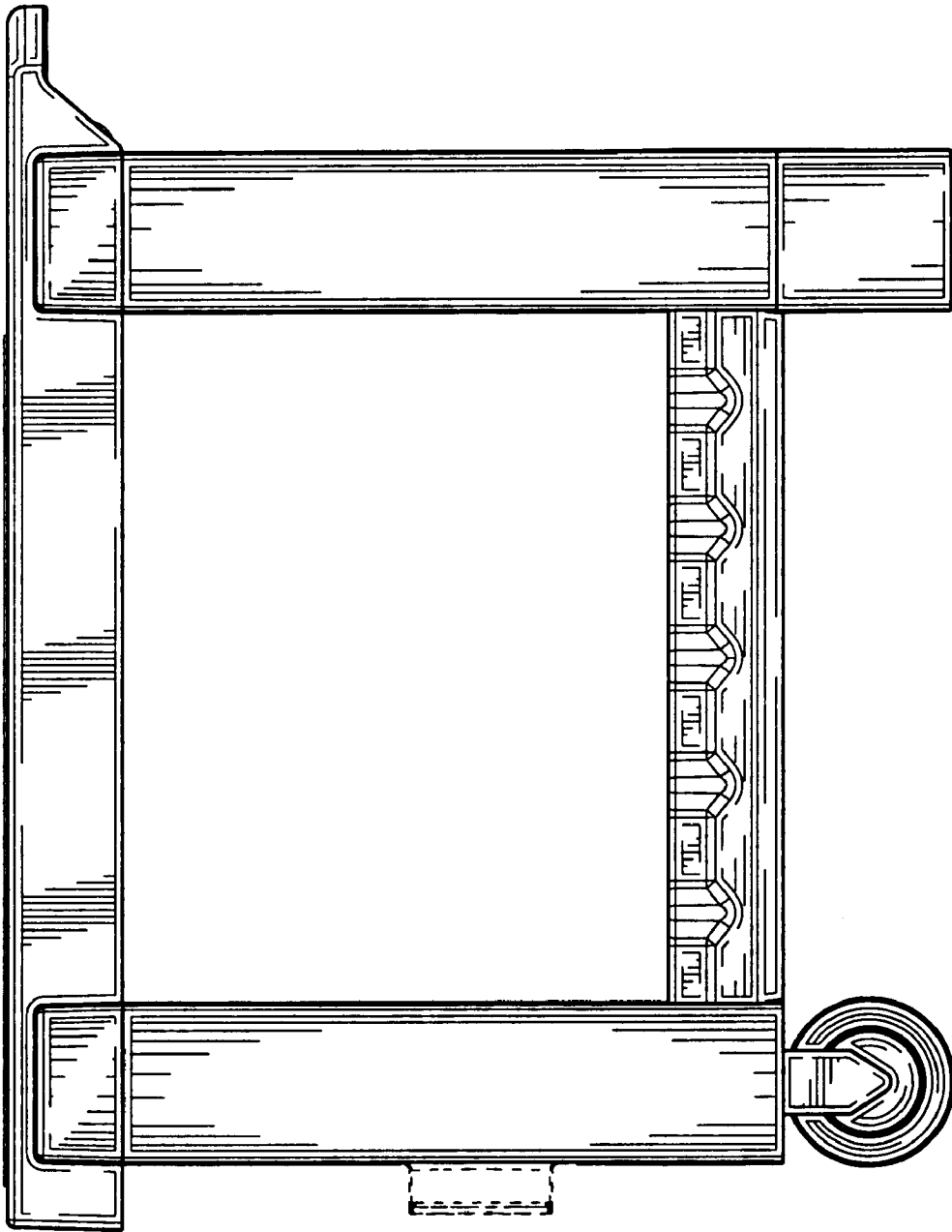

FIG. 2

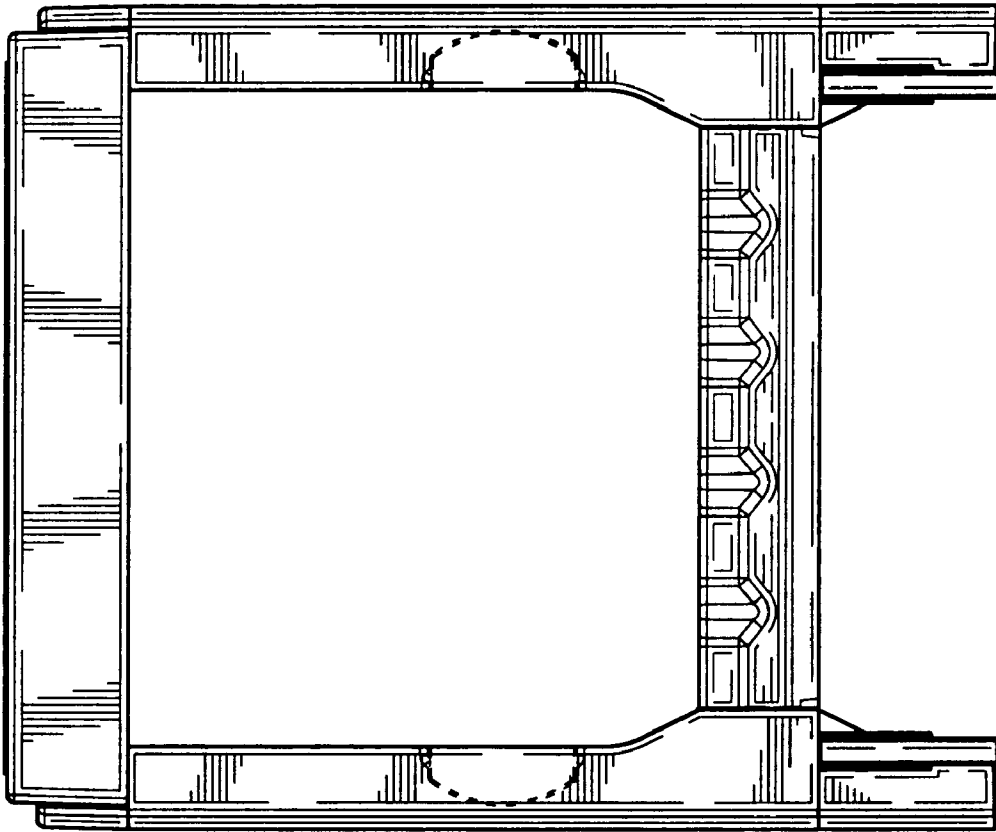

FIG. 3

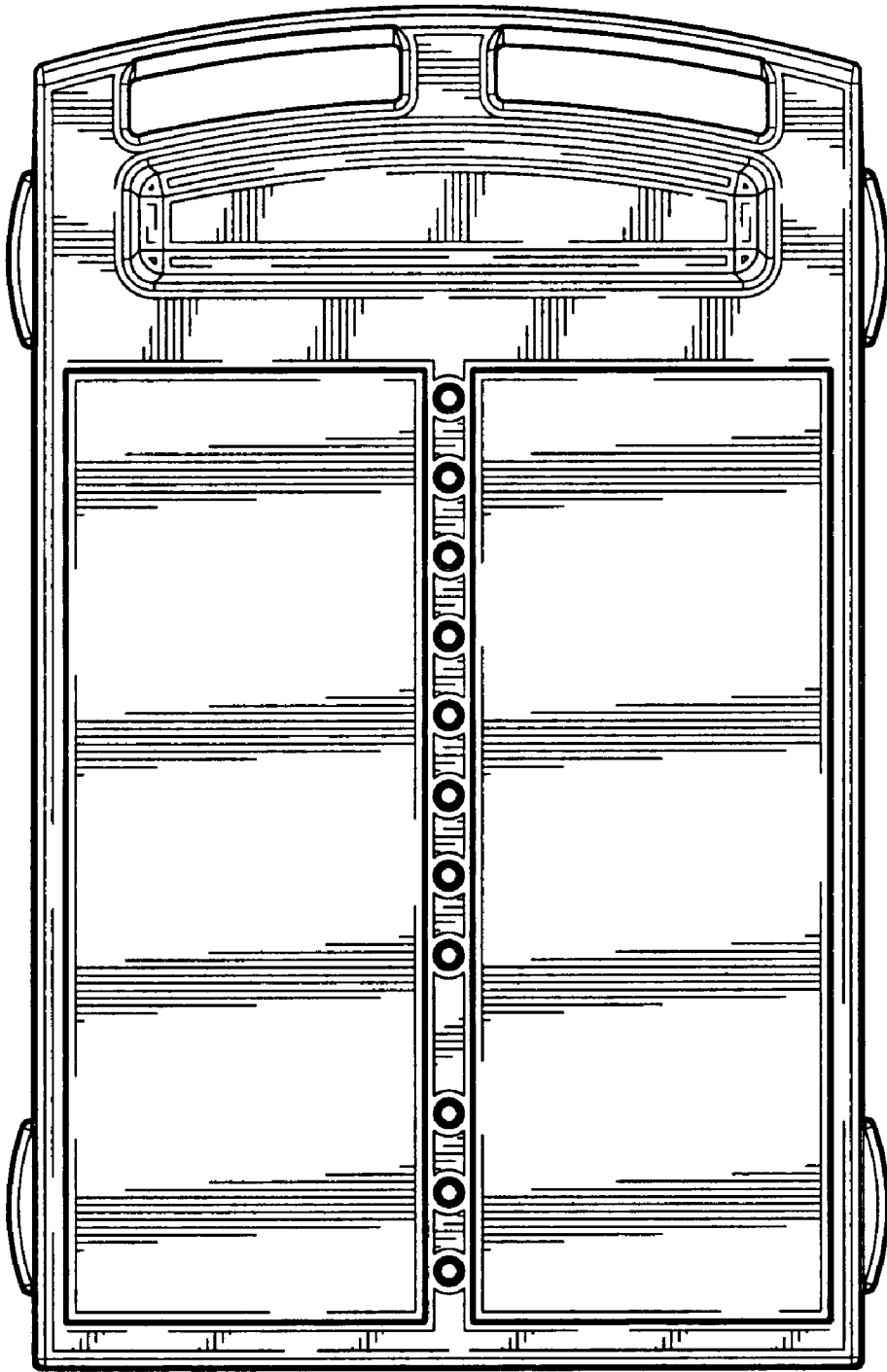

FIG. 4

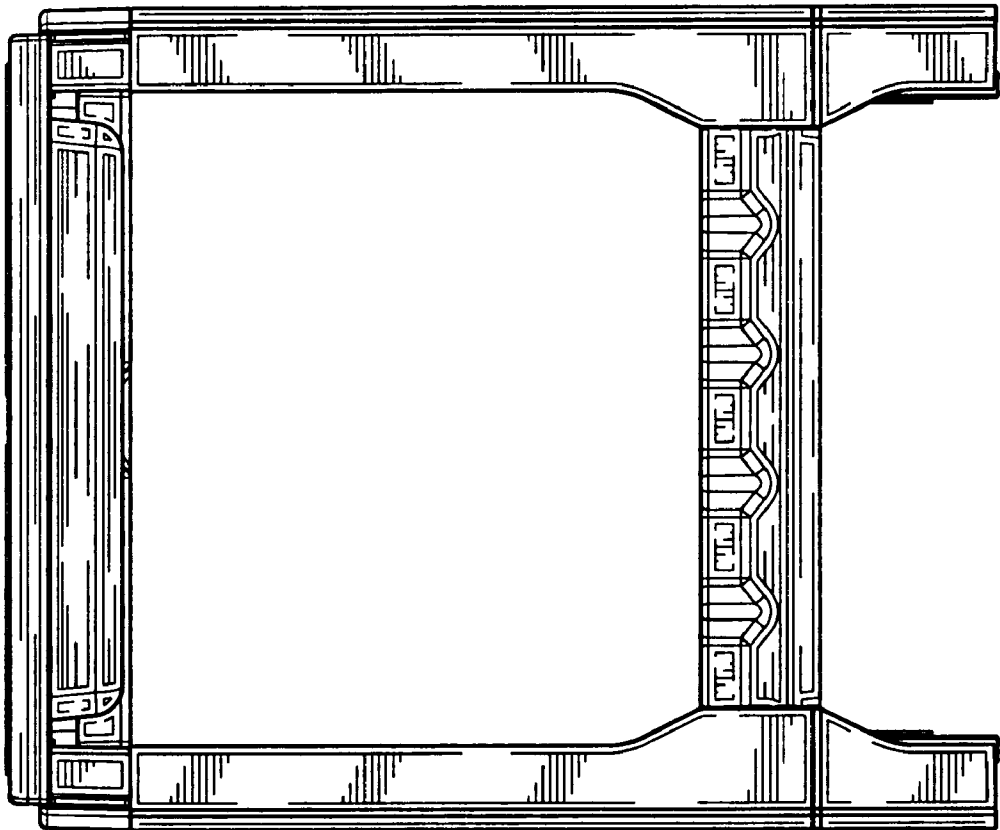

FIG. 5

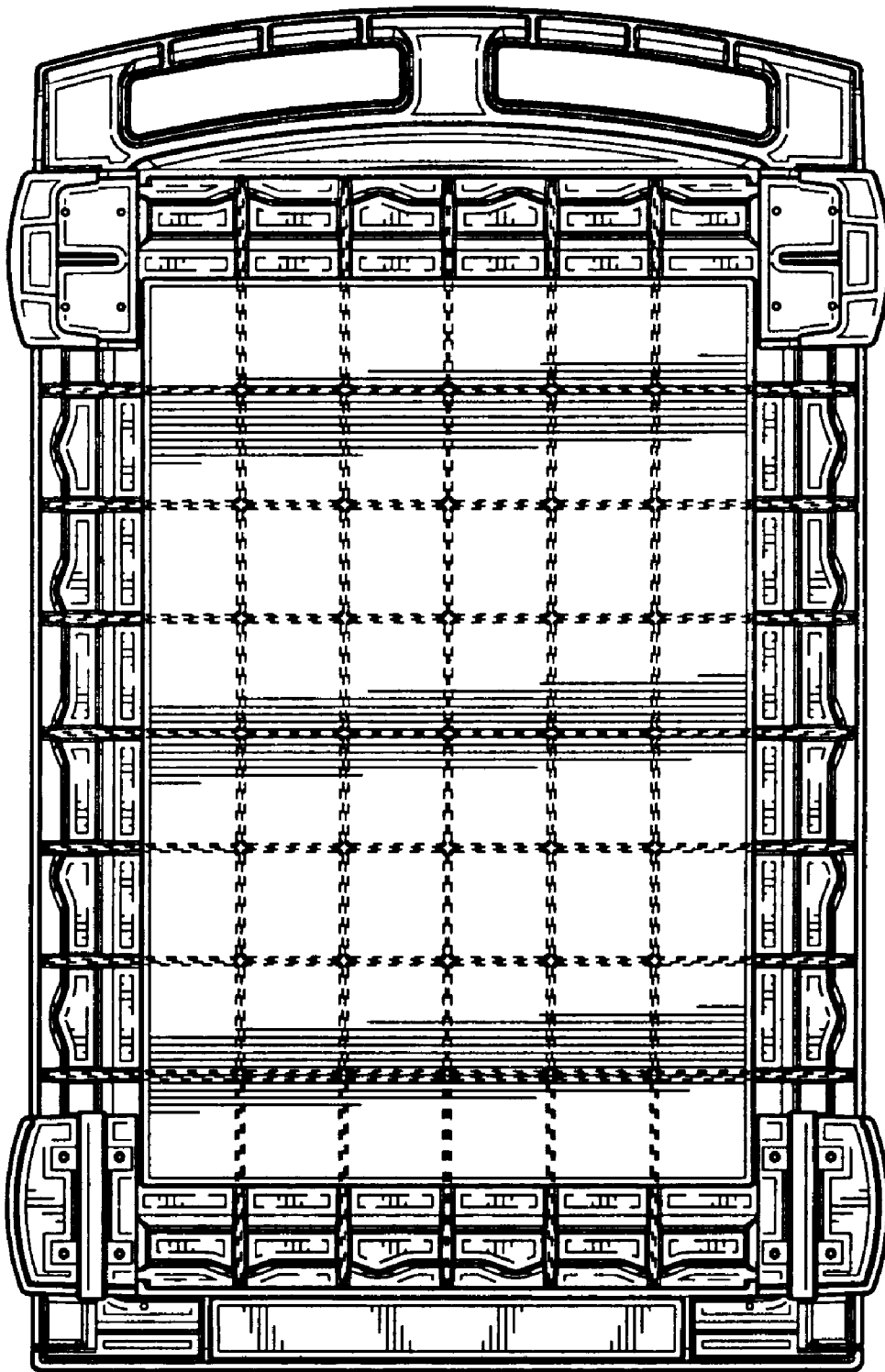

FIG. 6

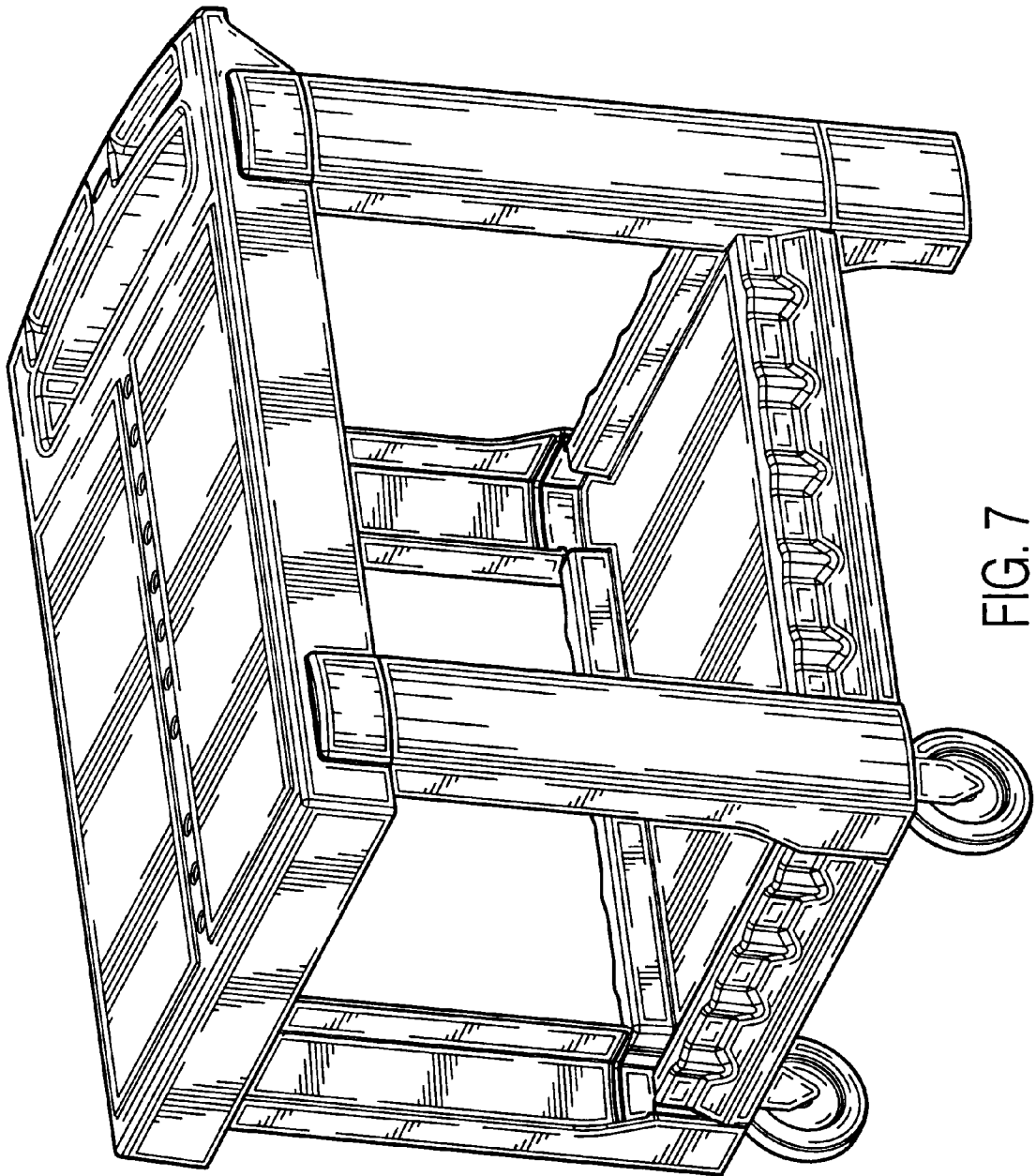

FIG. 7

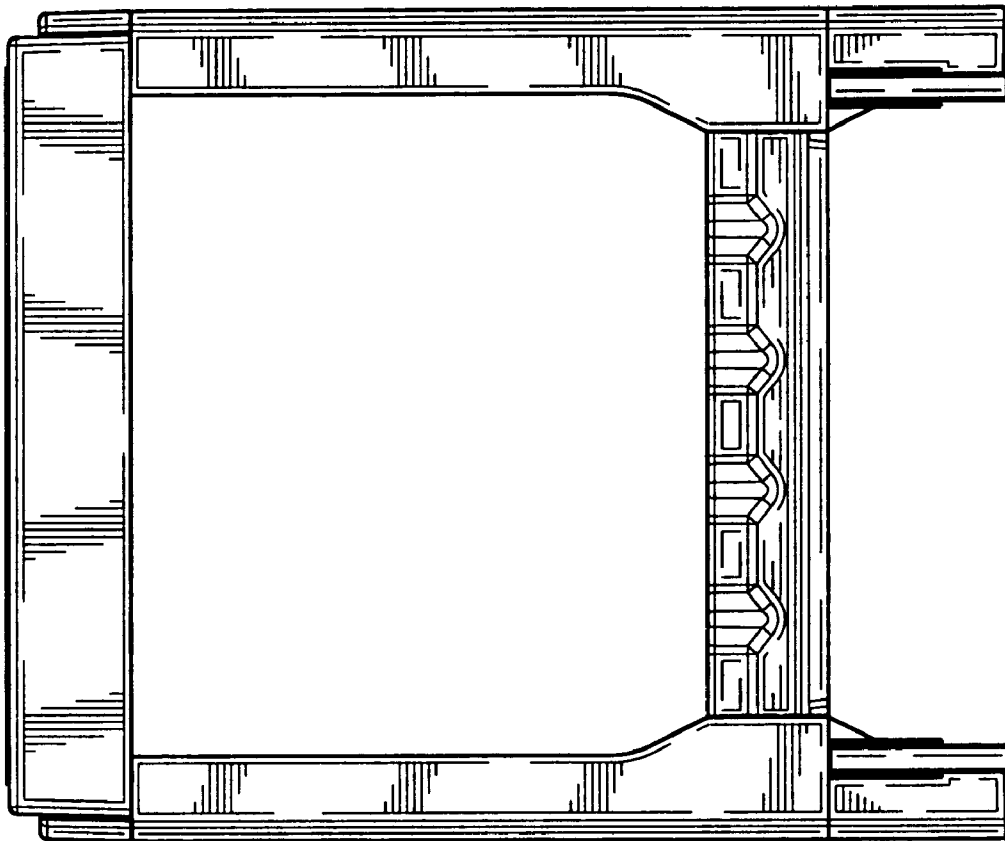

FIG. 8

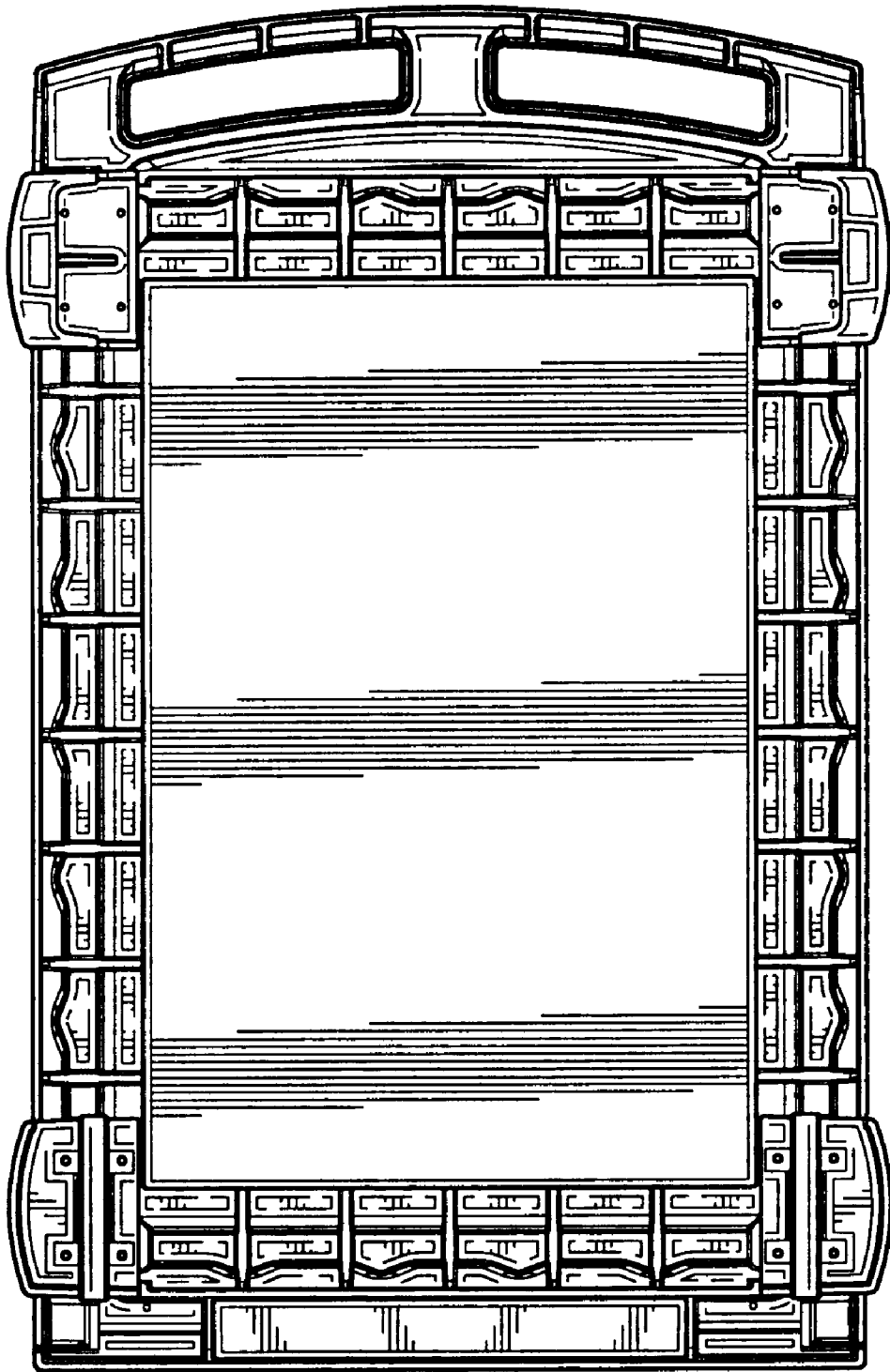

FIG. 9