

(19)



(11)

**EP 3 338 445 B1**

(12)

**EUROPEAN PATENT SPECIFICATION**

(45) Date of publication and mention of the grant of the patent:

**23.11.2022 Bulletin 2022/47**

(21) Application number: **16837204.3**

(22) Date of filing: **17.03.2016**

(51) International Patent Classification (IPC):

**H04N 5/225<sup>(2006.01)</sup> H04N 5/232<sup>(2006.01)</sup>**

(52) Cooperative Patent Classification (CPC):

**H04N 5/2258; H04N 5/232939; H04N 5/2257; H04N 5/232122; H04N 5/232123**

(86) International application number:

**PCT/KR2016/002703**

(87) International publication number:

**WO 2017/030262 (23.02.2017 Gazette 2017/08)**

(54) **PHOTOGRAPHING APPARATUS AND METHOD FOR CONTROLLING THE SAME**

FOTOGRAFIEVORRICHTUNG UND VERFAHREN ZUR STEUERUNG DAVON

APPAREIL PHOTO, ET PROCÉDÉ DE COMMANDE ASSOCIÉ

(84) Designated Contracting States:

**AL AT BE BG CH CY CZ DE DK EE ES FI FR GB GR HR HU IE IS IT LI LT LU LV MC MK MT NL NO PL PT RO RS SE SI SK SM TR**

(30) Priority: **17.08.2015 KR 20150115540**

(43) Date of publication of application:

**27.06.2018 Bulletin 2018/26**

(73) Proprietor: **Samsung Electronics Co., Ltd.**

**Suwon-si, Gyeonggi-do 16677 (KR)**

(72) Inventors:

- **LEE, Tae-hee**  
**Seoul 08865 (KR)**
- **MOON, Kyoung-hwan**  
**Suwon-si, Gyeonggi-do 16512 (KR)**

• **KANG, Kwon-jeong**  
**Gunpo-si, Gyeonggi-do 15853 (KR)**

• **HAN, Hee-chul**  
**Suwon-si, Gyeonggi-do 16699 (KR)**

• **KIM, Jae-gon**  
**Hwaseong-si, Gyeonggi-do 18483 (KR)**

(74) Representative: **D'Halleweyn, Nele Veerle Trees**

**Gertrudis et al**  
**Arnold & Siedsma**  
**Bezuidenhoutseweg 57**  
**2594 AC The Hague (NL)**

(56) References cited:

<b>WO-A1-2014/172530</b>	<b>KR-A- 20140 062 801</b>
<b>US-A1- 2007 201 726</b>	<b>US-A1- 2009 262 125</b>
<b>US-A1- 2011 080 494</b>	<b>US-A1- 2011 187 886</b>
<b>US-A1- 2013 128 072</b>	<b>US-A1- 2015 220 295</b>

**EP 3 338 445 B1**

Note: Within nine months of the publication of the mention of the grant of the European patent in the European Patent Bulletin, any person may give notice to the European Patent Office of opposition to that patent, in accordance with the Implementing Regulations. Notice of opposition shall not be deemed to have been filed until the opposition fee has been paid. (Art. 99(1) European Patent Convention).

**Description**

[Technical Field]

**[0001]** The disclosure relates generally to a photographing apparatus and a method for controlling the same, and for example, to a photographing apparatus having a plurality of camera modules and a method for controlling the same.

[Background Art]

**[0002]** A camera mounted on a portable terminal apparatus, such as, a smart phone, a tablet Personal Computer (PC), etc., is one of the most frequently used functions. Accordingly, technologies for enhancing performance of a camera mounted in a portable terminal apparatus have been developing.

**[0003]** However, as a portable terminal apparatus, such as, a smart phone, has a limited size, a size of a camera module mounted on the portable terminal device is being miniaturized to correspond to the size of the portable terminal apparatus.

**[0004]** Meanwhile, in order to satisfy user need for further enhancement of performance of the camera mounted on the portable terminal apparatus, for example, image quality, a camera sensor needs to be increased. However, as the size of the camera module mounted on the portable terminal apparatus has been miniaturized, there is a limit in enhancing the image quality of the camera.

**[0005]** In order to resolve such problems, technologies for mounting a multi-camera on a portable terminal apparatus, such as, a smart phone, have been developing. When the multi-camera is mounted on the portable terminal apparatus, it is possible for the apparatus to provide diverse image services. However, in this case, the multi-camera occupies a broader area than the conventional single camera, and thus, a foreign substance, such as, a user finger, may be easily exposed to a lens of the multi-camera. Accordingly, a user may do not perform a desired image photographing operation.

**[0006]** US 2011/0187886 A1 is related to an image pickup control unit displays either one of a picked-up image by a first image pickup unit and a picked-up image by a second image pickup unit on a display unit as a finder image. A feature detecting unit calculates a distribution of brightness values or brightness dispersion for each of the picked-up images by the first and second image pickup units, thereby detecting features of the two picked-up images. A sameness determining unit determines the sameness between both picked-up images based on the detected features, and determines that an abnormality like the unexpected appearance of an obstacle is present when the feature largely differs. When it is determined that an abnormality is present, a warning processing unit simultaneously displays both picked-up images on the display unit, or displays the picked-up im-

age including the abnormality on the display unit as a finder image.

**[0007]** US 2011/080494 A1 discloses an imaging apparatus including a camera module, a foreign object detection unit and a warning unit to notifying a user that a foreign object adheres to the optical lens. The warning message consists of displaying a warning indicating that a foreign object adheres to the optical lens or lighting up a warning lamp or outputting a warning tone.

**[0008]** US 2013/128072 A1 discloses an image pickup device including two camera modules situated on the same side of the device which detects, from a comparison between image information extracted from the preview images captured by the two camera modules, if one of the two camera modules is obstructed by a foreign object (e.g a finger). If a camera module is obstructed a warning information is displayed.

[Disclosure]

[Technical Problem]

**[0009]** The disclosure has been provided to address the aforementioned and other problems and disadvantages occurring in the related art, and an aspect of the disclosure provides a photographing apparatus which notifies a user of a state in which a foreign substance appears on at least one of a plurality of camera modules more intuitively.

**[0010]** In addition, an aspect of the disclosure provides a photographing apparatus which photographs an image or generates a composite image when a foreign substance does not exist on a plurality of camera modules.

[Technical Solution]

**[0011]** According to an aspect, a photographing apparatus is provided comprising features defined in the appended independent apparatus claim.

**[0012]** According to an another aspect, a method for controlling a photographing apparatus with a plurality of camera modules is provided comprising the steps defined in the appended independent method claim.

[Advantageous Effects]

**[0013]** According to the above-described various aspects of the disclosure, when a foreign substance appears on at least one of a plurality of camera modules, the photographing apparatus may notify a user of the state more intuitively.

[Description of Drawings]

**[0014]** The above and/or other aspects of the disclosure will be more apparent from the following detailed description, taken in conjunction with the accompanying drawings, in which like reference numerals refer to like

elements, and wherein:

FIG. 1A is a diagram illustrating an example photographing apparatus;  
 FIG. 1B is a diagram illustrating an example photographing apparatus;  
 FIG. 2 is a block diagram illustrating an example structure of a photographing apparatus;  
 FIG. 3 is a block diagram illustrating an example structure of a photographing apparatus;  
 FIG. 4 is a diagram illustrating an example photographable focusing region of a plurality of camera modules of a photographing apparatus;  
 FIG. 5A and FIG. 5B are demonstration diagrams illustrating an example of detecting an image in which an event occurred in a photographing apparatus;  
 FIG. 6 is a diagram illustrating an example of generating a composite image in a photographing apparatus;  
 FIG. 7A and FIG. 7B are first demonstration diagrams illustrating an example of providing a state notification service of a plurality of camera modules in a photographing apparatus;  
 FIG. 8 is a second demonstration diagram illustrating an example of providing a state notification service of a plurality of camera modules in a photographing apparatus;  
 FIG. 9A and FIG. 9B are third demonstration diagrams illustrating an example of providing a state notification service on a plurality of camera modules in a photographing apparatus;  
 FIG. 10 is a fourth demonstration diagram illustrating an example of providing a state notification service on a plurality of camera modules in a photographing apparatus;  
 FIG. 11 is a fifth demonstration diagram illustrating an example of providing a state notification service on a plurality of camera modules in a photographing apparatus;  
 FIG. 12 is a flowchart illustrating an example method for controlling a photographing apparatus; and  
 FIG. 13 is a flowchart illustrating an example method for generating a composite image from images generated by a plurality of camera modules in a photographing apparatus.

[Mode for Invention]

**[0015]** An overview of the description of the disclosure and accompanying drawings is provided in advance of describing the various example embodiments of the disclosure in greater detail.

**[0016]** Terms used in the following descriptions and claims are common expressions selected by considering functions in various examples of the disclosure. However, such terms may vary depending upon an intention of a person having ordinary skill in the art, legal/technical

interpretation, or advent of new technology. In addition, some of the terms may have been selected arbitrarily. The terms may be interpreted as defined herein, and unless otherwise defined, may be interpreted based on overall descriptions of the disclosure and common technical knowledge in the art.

**[0017]** In the following description, like drawing reference numerals and symbols refer to the like elements which perform the same or similar function substantially, even in different drawings, for convenience in explanation and for better understanding. For example, although a plurality of drawings share elements having the same reference numerals, the plurality of drawings do not necessarily relate to one or the same example.

**[0018]** In the following descriptions and claims, a term including an ordinal, such as, 'first,' 'second,' etc., may be used to distinguish elements. The ordinal is used to distinguish the same or similar elements and does not limit the meaning of the term. For instance, ordinals do not affect an order of use or an order of arrangement of elements expressed with the ordinals. Respective ordinals may be replaced with each other, if necessary.

**[0019]** In the following descriptions, a term in a singular form includes a plural form unless it is intentionally written that way. In addition, in the following descriptions, the terms 'include' and 'have' refer to the disclosed feature, number, step, operation, element, part, or combination thereof and are not intended to exclude any possibilities of existence or addition of one or more other features, numbers, steps, operations, elements, parts or combination thereof.

**[0020]** In the following descriptions, the terms 'module,' 'unit,' and 'part' may refer to an element which performs at least one function or operation. The element may be realized as hardware (e.g., circuitry), software, or combination thereof. In addition, a plurality of 'modules,' 'units,' and 'parts' may be integrated into at least one module or chip such that it is realized as at least one processor (not shown) except for a case where respective 'modules,' 'units,' and 'parts' need to be realized as discrete specific hardware.

**[0021]** When it is described that one part is connected to another part, the connection may include a direct connection between the parts and an indirect connection through other medium. In addition, the description that a certain part includes an element signifies that the part may further include other elements rather than signifying that the part excludes other elements, unless otherwise described.

**[0022]** Certain examples are described in greater detail below with reference to the accompanying drawings.

**[0023]** FIG. 1A is a diagram illustrating an example photographing apparatus, and FIG. 1B is a diagram illustrating an example photographing apparatus.

**[0024]** For example, a photographing apparatus may be realized as a portable terminal apparatus, such as, a smart phone, a tablet PC, etc., and includes a plurality of camera modules 10, 20 for photographing an image

(hereinafter referred to as 'first camera module' and 'second camera module'). According to an example, the first and second camera modules 10, 20 may, for example, be arranged in a vertical direction on a rear surface of the photographing apparatus, as illustrated in FIG. 1A.

According to another example, the first and second camera modules 10, 20 may, for example, be arranged in a horizontal direction on a rear surface of the photographing apparatus, as illustrated in FIG. 1B.

**[0025]** The first camera module 10 may include, for example, a wide-angle lens for a broad range of image photographing, and the second camera module 20 may include, for example, a telephoto lens for a long range of image photographing. The photographing apparatus may obtain images corresponding to a characteristic of the lens of each of the first and second camera modules 10, 20. For example, the first camera module 10 may, for example, provide a wider image than the second camera module 10 which is focused at the same distance as the first camera module 10. The second camera module 20 may, for example, provide an image which is out of the range of the first camera module 10.

**[0026]** As illustrated in FIG. 1A or FIG. 1B, a front surface of the photographing apparatus may include a display panel 30, and may be configured to determine an image generated by at least one of the first and second camera modules 10, 20 as a live image with respect to a subject to be photographed and display the determined image as the live image.

**[0027]** The display panel 30 may display a live image with respect to the image generated by at least one of the first and second camera modules 10, 20 and receive a command with respect to the displayed live image. In response to the command with respect to the live image, the photographing apparatus may photograph a still image or a moving image from the live image displayed in the display panel 30. In addition, in response to the command with respect to the live image, the photographing apparatus may, for example, generate a composite image by composing the images generated by the first and second camera modules 10, 20 or generate a three-dimensional (3D) image.

**[0028]** As described above, the photographing apparatus may determine the image generated by at least one of the first and second camera modules 10, 20 as a live image and display the image determined as the live image through the display panel 30.

**[0029]** For example, images may be generated through the first camera module 10 and the second camera module 20, and a live image with respect to the image generated by the first camera module 10 among the images generated by the first and second camera modules 10, 20 may be displayed through the display panel 30.

**[0030]** As illustrated in FIG. 1A or FIG. 1B, a user's finger may come into contact with, for example, the second camera module 20 while the live image with respect to the image generated by the first camera module 10 is displayed. In this case, an image relevant to the user's

finger may be inserted into a certain region of an image generated by the second camera module 20. The photographing apparatus determines that the an event (e.g., a finger being inserted into a region of an image) occurs by analyzing the image generated by the second camera module 20 and displays the image in which the event occurred in the display panel 30.

**[0031]** Accordingly, the user may recognize that his/her finger came into contact with the second camera module 20 and move the finger to a region in which the first and second camera modules 10, 20 are not arranged.

**[0032]** As described above, the photographing apparatus may analyze images generated by at least one of the first and second camera modules 10, 20, detect an image in which an event occurred, and display the detected image so that a user is able to recognize a current photographing state more intuitively.

**[0033]** Hereinafter, respective components of the photographing apparatus will be described in greater detail.

**[0034]** FIG. 2 is a block diagram illustrating an example structure of an example photographing apparatus, and FIG. 3 is a more detailed block diagram illustrating an example structure of an example photographing apparatus.

**[0035]** As illustrated in FIG. 2, the photographing apparatus includes a photographing unit 110, a first buffer (e.g., including a memory) 120, a second buffer (e.g., including a memory) 130, a display 140, and a controller 150. As illustrated in FIG. 3, the photographing apparatus may further include an image processor 160, a communicator (e.g., including communication circuitry) 170, an input unit (e.g., including input circuitry) 180, and a storage 190, in addition to the components described above with reference to FIG. 2.

**[0036]** For example, the photographing unit 110 for photographing an image may be applied to a photographing apparatus such as a Compact System Camera (CSC). The photographing unit 110 may include a plurality of camera modules 111, 113 (hereinafter referred to, for example, as 'first camera module' and 'second camera module'). The first camera module 111 may include, for example, a wide-angle lens for a broad range of image photographing, and the second camera module 113 may include, for example, a telephoto lens for a long range of image photographing.

**[0037]** The photographing unit 110 may obtain images corresponding to a characteristic of the lens of each of the first and second camera modules 111, 113. For example, the photographing unit 110 may provide a wider image than the second camera module 113 which is focused at the same distance as the first camera module 111, through the first camera module 111. In addition, the photographing unit 110 may provide an image which is out of range of the first camera module 111, through the second camera module 113.

**[0038]** The first and second camera modules 111, 113 receive external light admitted through the lens (the wide-

angle lens and the telephoto lens) included in each camera module and convert the received external light into an electrical signal. For example, in response to the external light being admitted through each lens driven by a control command of the controller 150 and being formed on an imaging surface, the first and second camera modules 111, 113 may convert the external light formed on the imaging surface into an electrical signal using a photoelectric conversion device such as, for example, a Charge Coupled Device (CCD) or Complementary Metal Oxide Semiconductor (CMOS), or the like. A more detailed description on the controller 150 will be provided below. In this case, a position of each lens included in the first and second camera modules 111, 113 may be changed based on a control command of the controller 150 thereby expanding or reducing a size of a subject to be photographed or performing autofocus for adjusting a focus with respect to a subject.

**[0039]** The image processor 160 illustrated, for example, in FIG. 3 processes raw image data with respect to the electrical signal converted by the first and second camera modules 111, 113 of the photographing unit 110 to generate a live image with respect to the subject to be photographed.

**[0040]** The above-described method for converting an external light into an electrical signal by using the photographing unit 110 and the image processor 160 and generating a live image from the converted electrical signal pertains to the common knowledge in the art in connection with a camera having an electric or optical viewfinder, and thus, the detailed description is omitted.

**[0041]** The first buffer 120 temporarily stores a plurality of images generated by the first camera module 111 among the plurality of camera modules. The second buffer 130 temporarily stores a plurality of images generated by the second camera module 113 among the plurality of camera modules. For example, the first and second buffers 120, 130 temporarily store the plurality of images generated by the first and second camera modules 111, 113 in connection with a subject to be photographed, before a command relevant to a photographing operation is received. In this case, it is desirable that the plurality of images being temporarily stored in the first and second buffers 120, 130 are stored sequentially based on a generated order.

**[0042]** In addition, it may be desirable that the first and second buffers 120, 130 match and store at least one of the plurality of images being temporarily stored, image information on each image, and photographing information. In this case, the image information may include, for example, at least one of brightness information, histogram information, and pixel information of an image, and the photographing information may include at least one of lens position information for autofocus, phase difference information, and contrast level information of each camera module in connection with generating an image.

**[0043]** The first and second buffers 120, 130 may, for example, match and store at least one of the plurality of

images being temporarily stored, the image information of each image, and the photographing information.

**[0044]** The display 140 displays the image generated by the first camera module 111 among the plurality of camera modules as a live image. In the example, it is described that the images generated by the first camera module 111 are displayed as a live view, but is not limited thereto. For example, the image generated by the second camera module 113 among the plurality of camera modules may be also displayed as a live image. In addition, each of the image generated by the first and second camera modules 111, 113 may be displayed as a live image.

**[0045]** The display 140 may display a photographed still image, a photographed moving image, and a command-related UI for controlling an operation of the photographing apparatus, on top of or overlapping a live image with respect to a subject to be photographed. The display 140 may, for example, be realized as a Liquid Crystal Display (LCD), Organic Light-Emitting Diode (OLED), Plasma Display Panel (PDP), etc. Further, the display 140 may, for example, be realized as a touch panel for receiving a touch command in connection with a displayed UI.

**[0046]** The controller 150 is configured to analyze the images stored in the first buffer and second buffers 120, 130 using, for example, at least one of the image information of each image stored in the first and second buffers 120, 130 and the photographing information of the first and second camera modules 111, 113. In response to analyzing that an event occurs in at least one of the plurality of images stored in the second buffer 130, the controller 150 is configured to control the display 140 to provide a state notification service on the second camera module 113.

**[0047]** An image in which an event occurred may, for example, be an image generated by the second camera module 113 while a part of or an entire part of the second camera module 113 is covered with a foreign substance, such as, for example, a user's finger, or, for example, an auto-focused image different from other images stored in the second buffer 130.

**[0048]** For example, in response to an image in which an event occurred being detected, the controller 150 may be configured to control the display 140 to convert and display a live image with respect to the image generated by the first camera module 111 to the image in which the event occurred.

**[0049]** For example, in response to an image in which the event occurred being detected, the controller 150 may be configured to control the display 140 to display a live image with respect to the image generated by the first camera module 111 in a first region of the display 140 and display an event UI with respect to the image in which the event occurred in a second region on the display 140.

**[0050]** For example, as illustrated in FIG. 3, the display 140 may include a main display 141 and a curved-surface auxiliary display 143 which is extended in a certain di-

rection from the main display 141.

**[0051]** For example, in response to the image in which the event occurred being detected, the controller 150 may be configured to control the display 140 to display the live image with respect to the image generated by the first camera module 111 in the main display 141. In addition, the controller 150 may be configured to control the display 140 to display an event UI with respect to the image in which the event occurred, for example, the event UI with respect to the images generated by the second camera module 113, in the curved-surface auxiliary display 143. Based on the control command, the display 140 may display the live image in the main display 141 and display the event UI with respect to the image in which the event occurred in the curved-surface auxiliary display 143.

**[0052]** For example, in response to the image in which the event occurred being detected, the controller 150 may be configured to control the communicator (e.g., including communication circuitry) 170 to transmit event occurrence-related information to an adjacent terminal apparatus (not shown). The communicator 170 may transmit the event occurrence-related information to the adjacent terminal apparatus (not shown), and the adjacent terminal apparatus (not shown) may provide a state notification service of the second camera module 113 based on the event occurrence-related information received from the photographing apparatus. According to an example, the adjacent terminal apparatus (not shown) may provide a notification that a photographing operation of the second camera module 113 may be performed abnormally through a notification service, such as, for example, a vibration feedback, a message alarm feedback, a beep sound feedback, a lamp alarm feedback, etc., based on the event occurrence-related information received from the photographing apparatus.

**[0053]** Meanwhile, the communicator 170 which transmits the event occurrence-related information to the adjacent terminal apparatus (not shown) may include, for example, a local area communication module 171, a wireless communication module 173, such as, a wireless Local Area Network (LAN) module, and a connector 175 including at least one of wired communications modules such as a High Definition Multimedia Interface (HDMI), a Universal Serial Bus (USB), Institute of Electrical and Electronics Engineers (IEEE) 1394, etc.

**[0054]** The local area communication module 171 may perform local area communication between the photographing apparatus and the adjacent terminal apparatus (not shown) in a wireless manner. The local area communication module 171 may include, for example, at least one of a Bluetooth module, an Infrared Data Association (IrDA) module, a Near Field Communication (NFC) module, a Wireless-Fidelity (Wi-Fi) module, and a Zigbee module, or the like.

**[0055]** The wireless communication module 173 may be connected to an external network according to a wireless communication protocol, such as, for example,

IEEE, to perform communication. The wireless communication module 173 may further include a mobile communication module which performs communication by accessing a mobile communication network according to diverse mobile communication standards such as 3rd Generation (3G), 3rd Generation Partnership Project (3GPP), Long Term Evolution (LTE), etc.

**[0056]** As described above, the communicator 170 may, for example, be realized by various local area communication methods, and other communication methods and/or communication circuitry which are not mentioned in the disclosure may be employed based on need.

**[0057]** The connector 175 may provide an interface with respect to various source apparatuses, such as, USB 2.0, USB 3.0, HDMI, IEEE 1394, etc. The connector 175 may receive content data transmitted from an external server (not shown) or transmit pre-stored content data to an external recording medium through a wired cable connected to the connector 175, based on a control command of the controller 150. In addition, the connector 175 may be supplied with power through a wired cable which is physically connected to the connector 175.

**[0058]** The input unit 180 may include, for example, input circuitry that serves as an input means for receiving various commands and transmitting the commands to the controller 150. The input unit 180 may include, for example, a manipulation unit (not shown) and a touch input unit (not shown) for receiving a user manipulation command and a second input unit (not shown) for receiving a control signal corresponding to a command from a remote control apparatus (not shown).

**[0059]** The manipulation unit (not shown) may, for example, be realized as a keypad having various function keys, number keys, special keys, letter keys, etc. The touch input unit (not shown) may, for example, be realized as a touch pad forming a mutual layer structure with the display 140 in response to the display 140 being realized as a touch screen.

**[0060]** The second input unit (not shown) may, for example, receive a command, such as, a channel tuning command, a function setting command with respect to the photographing apparatus, etc., through a control command including an Infrared Rays (IR) signal, a Radio Frequency (RF) signal, and the like from the remote control apparatus (not shown) or a voice signal with respect to a user's uttered voice.

**[0061]** The storage 190 may, for example, store diverse images and an Operating System (OS) for controlling the operations of the photographing apparatus. For example, the OS may be a program which is read from the storage 190 and compiled to operate each component of a portable terminal apparatus 100 in response to the photographing apparatus being turned on. The storage 190 may, for example, be realized as at least one of Read-Only Memory (ROM), Random Access Memory (RAM), a memory card which is detachable or mountable with respect to a portable terminal apparatus 100 (for example, a Secure Digital (SD) card, a memory stick,

etc.), a non-volatile memory, a volatile memory, a Hard Disk Drive (HDD), and a Solid State Disk (SSD), or the like.

**[0062]** In response to a composite photographing command being received through the input unit 180, the controller 150 is configured to generate a composite image from an image at a point of time when the composite photographing command is received among the images stored in the first and second buffers 120, 130 and to control the display 140 to display the generated composite image. According to an example, the controller 150 is configured to generate depth information from a value of each pixel constituting the images stored in the first and second buffers 120, 130 and to compose each image based on the depth information. However, this method is only an example, and a composite image is generated from the images which are temporarily stored in the first and second buffers 120, 130 by various well-known composite algorithms. In response to a composite image being generated according to the example, the display 140 displays the composite image obtained from the images stored in the first and second buffers 120, 130.

**[0063]** In response to an image in which the event occurred being detected, the controller 150 is configured to generate a composite image from an image adjacent to the image in which the event occurred from among the images stored in the first buffer 120 and the images stored in the second buffer 130. For example, an image in which an event occurred at a point of time when the composite photographing command is received is detected. In this case, the controller 150 is configured to extract the image adjacent to the image in which the event occurred from the second buffer 130. The image adjacent to the image in which the event occurred is an image stored in the second buffer 130 immediately before the image in which the event occurred is temporarily stored in the second buffer 130. In response to the adjacent image being extracted, the controller 150 is configured to generate a composite image from the image stored at the point of time when the composite photographing command is received among the images stored in the first buffer 120 and the image extracted from the second buffer 130. The display 140 displays the composite image obtained from the images stored in the first and second buffers 120, 130.

**[0064]** Before generating the composite image from the images stored in the first and second buffers 120, 130, the controller 150 may be configured to determine whether it is possible to generate a composite image from the images stored in the first and second buffers 120, 130, according to the example discussed below.

**[0065]** According to an example, in response to a composite photographing command being received, the controller 150 may be configured to determine whether to generate a composite image based on an occlusion region based on parallax of each image stored in the first and second buffers 120, 130 and a predetermined value (e.g., a predetermined critical value). For example, in re-

sponse to a composite photographing command being received, the controller 150 may be configured to detect an occlusion region based on the parallax of each image stored in the first and second buffers 120, 130. The controller 150 may be configured to determine whether a detected amount of the detected occlusion region is greater than the predetermined value, for example, a predetermined critical value. In response to determining that the detected amount of the detected occlusion region is greater than the predetermined critical value, the controller 150 may be configured to select one of the images stored in the first and second buffers 120, 130 and to control the display 140 to display the selected image. The display 140 may display the image selected from among the images stored in the first and second buffers 120, 130.

**[0066]** According to another example, the controller 150 may be configured to determine whether to generate a composite image based on focusing information of each of the first and second camera modules 111, 113 and close-up photographing information corresponding to a command. For example, the first camera module 111 may include a wide-angle lens, and the second camera module 113 may include a telephoto lens.

**[0067]** For example, a photographable focusing distance may be applied differently to the first camera module 111 and the second camera module 113 based on the characteristic of the lens of each module.

**[0068]** FIG. 4 is a demonstration diagram illustrating an example photographable focusing region of a plurality of camera modules of a photographing apparatus.

**[0069]** As illustrated in FIG. 4, the first camera module 111 having a wide-angle lens may focus on a subject, ranging from a first point (A) at a close distance to a third point (C) at a long distance. The second camera module 113 having a telephoto lens may focus on a subject, ranging from a second point (B) farther than the first point (A) at the close distance to the third point (C) at the long distance.

**[0070]** For example, the second camera module 113 having the telephoto lens may focus on a subject located at a relatively long distance as compared with the first camera module 111 having a wide-angle lens but is unable to focus on a subject located at a close distance. In response to a composite photographing command being received while close-up photographing information on a subject between the first point (A) which is out of range of the second camera module 113 and the second point (B) is received, the controller 150 may be configured to determine that compositeness of the images generated by the second camera module 113 is unavailable based on the received close-up photographing information and the focusing information on the first and second camera modules 111, 113.

**[0071]** In response to determining that the compositeness of the images generated by the second camera module 113 is unavailable, the controller 150 may be configured to select an image stored in the first buffer

120 among the images stored in the first and second buffers 120, 130 and to control the display 140 to display the selected image. The display 140 may display the image selected from the images stored in the first buffer 120.

**[0072]** An operation of detecting an image in which an event occurred in the photographing apparatus according to an example will be described in greater detail below.

**[0073]** FIG. 5A and 5B are demonstration diagrams illustrating an example of detecting an image in which an event occurred in a photographing apparatus.

**[0074]** As illustrated in FIG. 5A and FIG. 5B, the controller 150 may be configured to analyze a plurality of images stored in the first and second buffers 120, 130 and to detect an image in which an event occurred. For example, as illustrated in FIG. 5A, the controller 150 may be configured to measure similarity in the images stored in the first buffer 120. In addition, as illustrated in FIG. 5B, the controller 150 may be configured to measure similarity in the images stored in the second buffer 130.

**[0075]** The similarity in the images stored in the first and second buffers 120, 130 may be measured from at least one of brightness information, histogram information, and pixel information of an image. As illustrated, in response to a similarity value measured from the image stored in the first buffer 120 being lower than a similarity value measured from the image stored in the second buffer 130, the controller 150 may be configured to determine that an event occurs in the image stored in the first buffer 120. In this case, the images stored in the first buffer 120 may be images generated by the first camera module 111. In response to determining that an event occurred in the image stored in the first buffer 120, the controller may be configured to provide a state notification service on the first camera module 111 among the first and second camera modules 111, 113, according to the above-described various examples.

**[0076]** A user is able to recognize that his/her finger covers the first camera module 111 intuitively through the notification service and to move the finger covering the first camera module 111. The first and second camera modules 111, 113 may generate images with respect to a subject to be photographed normally.

**[0077]** FIG. 6 is a diagram illustrating an example of generating a composite image in a photographing apparatus.

**[0078]** FIG. 6 illustrates an example in which a plurality of images generated by the first camera module 111 are stored temporarily in the first buffer 120 based on a time sequence.

**[0079]** The first and second camera modules 111, 113 generate images at the same timing, and the generated images are stored in the first and second buffers 120, 130 temporarily in a sequential order. For example, eight images are stored in the first and second buffers 120, 130, respectively, and a composite photographing command is input at a point of time when the eighth image

is stored. In this case, the controller 150 is configured to compose eighth images 610-1, 610'-1 stored in the first and second buffers 120, 130 at the point of time the composite photographing command is input. Before composing the eighth images stored in the first and second buffers 120, 130, the controller 150 is configured to determine whether an event has occurred based on at least one of the image information on the plurality of images respectively stored in the first and second buffers 120, 130 and the photographing information.

**[0080]** According to an example, the controller 150 may be configured to determine whether an event occurs using at least one of the brightness information, histogram information, and pixel information of the images stored in the first and second buffers 120, 130.

**[0081]** When determining occurrence of an event based on the brightness information, the controller 150 may be configured to determine the similarity between two images based on the brightness information of the eighth images 610-1, 610'-1 respectively being stored in the first and second buffers 120, 130 at the point of time when the composite photographing command is received and the brightness information of preceding images (seventh images 610-2, 610'-2). For example, the controller 150 may be configured to determine a difference value in brightness between two images based on the brightness information of the two images and to determine the similarity of the two images based on the determined difference value and a predetermined critical value. In response to determining that the determined difference value is greater than the predetermined critical value, the controller 150 may be configured to determine that the two images are similar to each other. In response to determining that the determined difference value is less than the predetermined critical value, the controller 150 may be configured to determine that the two images are different from each other.

**[0082]** According to the example, in response to determining that the two images are different, the controller 150 may be configured to detect the eighth image of a buffer of which two images are determined as being different, out of the first and second buffers 120, 130, as an image in which the event occurred.

**[0083]** According to another example, the controller 150 may be configured to determine whether an event occurs based on the photographing information including at least one of the lens position information for autofocus, phase difference information, and contrast level information on the first and second camera modules 111, 113.

**[0084]** When determining the occurrence of an event based on the lens position information, the controller 150 may be configured to compare the lens position information of the eighth images 610-1, 610'-1 respectively being stored in the first and second buffers 120, 130 and the preceding images 610-2, 610'-2 to determine a similarity between the two images. For example, the controller 150 may be configured to determine a distance difference between the lenses based on the lens position informa-

tion on the two images. In response to the determined distance difference being less than a predetermined critical value, the controller 150 may be configured to determine that the two images are similar to each other. In response to the determined distance difference being greater than the predetermined critical value, the controller 150 may be configured to determine that the two images are different from each other.

**[0085]** According to the example, in response to determining that the two images are different, the controller 150 may be configured to detect the eighth image of a buffer of which two images are determined as being different, out of the first and second buffers 120, 130, as an image in which the event occurred.

**[0086]** According to the above-described various examples, the controller 150 is configured to detect an image in which the event occurred. In addition, as illustrated, the eighth image 610'-1 of the second buffer 130 is detected as an image in which the event occurred. As such, in response to the image in which the event occurred being detected, the controller 150 is configured to extract an image (the seventh image 610'-2) adjacent to the eighth image 610'-1 detected as the image in which the event occurred. The controller 150 is configured to generate a composite image by composing the eighth image 610-1 stored in the first buffer 120 and the seventh image 610'-2 stored in the second buffer 130.

**[0087]** Hereinafter, an operation of providing a state notification service on the plurality of camera modules 111, 113 in the photographing apparatus will be described in greater detail below.

**[0088]** FIG. 7A and 7B are diagrams illustrating an example of providing a state notification service on a plurality of camera modules in a photographing apparatus.

**[0089]** As illustrated in FIG. 7A, the photographing apparatus may determine and display an image 710 generated by the predetermined first camera module among the first and second camera modules 111, 113 as a live image.

**[0090]** In this case, before receiving a photographing command, the photographing apparatus may temporarily store a plurality of images generated by the first camera module 111 in the first buffer 120 and temporarily store a plurality of images generated by the second camera module 113 in the second buffer 130.

**[0091]** As described above, while the plurality of images generated by the first and second camera modules 111, 113 are temporarily stored in the first and second buffers 120, 130, the photographing apparatus analyzes the plurality of images stored in the first and second buffers 120, 130 using, for example, at least one of the image information on each of the plurality of images stored in the first and second buffers 120, 130 and the photographing information.

**[0092]** In response to analyzing that at least one of the images stored in the second buffer 130 is an image in which an event occurred, as illustrated in FIG. 7B, the photographing apparatus may determine and display the

image in which the event occurred 720 as a live image. For example, the photographing apparatus may display a live image with respect to the image 720 including a foreign substance 721. Accordingly, a user is able to recognize that his/her finger covers a part of the lens of the second camera module 113 based on the displayed live image, move the finger to another place, and then perform a photographing operation.

**[0093]** Accordingly, in response to a photographing command being received, the photographing apparatus may photograph images or compose photographed images while no foreign substance exists on the first and second camera modules 111, 113.

**[0094]** FIG. 8 is a diagram illustrating an example of providing a state notification service on a plurality of camera modules in a photographing.

**[0095]** As described above in connection with FIG. 7A, the photographing apparatus may display an image 710 generated by the predetermined first camera module 111 among the first and second camera modules 111, 113 as a live image.

**[0096]** In this case, before receiving a photographing command, the photographing apparatus may temporarily store a plurality of images generated by the first camera module 111 in the first buffer 120 and temporarily store a plurality of images generated by the second camera module 113 in the second buffer 130.

**[0097]** As described above, while the plurality of images generated by the first and second camera modules 111, 113 are temporarily stored in the first and second buffers 120, 130, the photographing apparatus analyzes the plurality of images stored in the first and second buffers 120, 130 using, for example, at least one of the image information on each of the plurality of images stored in the first and second buffers 120, 130 and the photographing information.

**[0098]** In response to analyzing that at least one of the images stored in the second buffer 130 is an image in which an event occurred, as illustrated in FIG. 8, the photographing apparatus may display a live image 810 in the main display 141 and may display an event UI 820 with respect to the plurality of images stored in the second buffer 130, the plurality of images including the image in which the event occurred, in the curved-surface auxiliary display 143. In this case, the event UI displayed in the curved-surface auxiliary display 143 may be a thumbnail image corresponding to each of the plurality of images stored in the second buffer 130. The photographing image displays the live image 810 in the main display 141 and display thumbnail images corresponding to the plurality of images stored in the second buffer 130 including the image in which the event occurred in the curved-surface auxiliary display 143. Accordingly, a user is able to recognize that his/her finger covers a part of the lens of the second camera module 113 based on the thumbnail images displayed in the curved-surface auxiliary display 143, move the finger to another place, and then perform a photographing operation.

**[0099]** In addition, the photographing apparatus may, for example, apply a highlight effect to a thumbnail image corresponding to an image in which the event occurred among the thumbnail images corresponding to the plurality of images displayed in the curved-surface auxiliary display 143, but is not limited thereto. For example, the photographing apparatus may apply various event effects that a user is able to recognize to a thumbnail image corresponding to an image in which the event occurred among the thumbnail images corresponding to the plurality of images displayed in the curved-surface auxiliary display 143.

**[0100]** As described above, as the photographing apparatus may apply a highlight effect to the thumbnail image corresponding to the image in which the event occurred, the user is able to recognize that his/her finger covers a part of the lens of the second camera module 113 more intuitively through the highlighted thumbnail image.

**[0101]** FIG. 9A and FIG. 9B are diagrams illustrating an example of providing a state notification service on a plurality of camera modules in a photographing.

**[0102]** As illustrated in FIG. 9A, the photographing apparatus may determine an image 910 generated by the predetermined first camera module 111 among the first and second camera modules 111, 113 as a live image and display the image determined as the live image through the main display 141. In addition, the photographing apparatus may display an event UI 920 with respect to histogram information of an image generated by the second camera module 113 at a point of time when the image determined as the live image was generated through the curved-surface auxiliary display 143.

**[0103]** According to an example, in response to determining that an event does not occur based on an analysis of the image generated by the second camera module 113, the photographing apparatus may display the event UI 920 with respect to the histogram information in, for example, a strip form including a first color through the curved-surface auxiliary display 143.

**[0104]** Before receiving a photographing command, the photographing apparatus may temporarily store a plurality of images generated by the first camera module 111 in the first buffer 120 and temporarily store a plurality of images generated by the second camera module 113 in the second buffer 130.

**[0105]** As described above, while the plurality of images generated by the first and second camera modules 111, 113 are temporarily stored in the first and second buffers 120, 130, the photographing apparatus analyzes the plurality of images stored in the first and second buffers 120, 130 using, for example, at least one of the image information on each of the plurality of images stored in the first and second buffers 120, 130 and the photographing information.

**[0106]** In response to at least one of the images stored in the second buffer 130 being detected as an image in which the event occurred, as illustrated in FIG. 9B, the

photographing apparatus may display an event UI 920' of which color has been changed to a second color different from the first color through the curved-surface auxiliary display 143. In this case, the photographing apparatus may provide the event UI 920' which displays an entire part of a display region of the curved-surface auxiliary display 143 in the second color different from the first color or provide the event UI 920' which displays a part of the display region of the curved-surface auxiliary display 143 in the second color. In response to a part of the display region of the curved-surface auxiliary display 143 being displayed in the second color, the photographing apparatus may determine a region in which the second color is displayed based on an order of storing the image in which the event occurred.

**[0107]** For example, in response to an image which has been stored most recently among the images temporarily being stored in the second buffer 130 being detected as an image in which the event occurred, the photographing apparatus may display a right region of the curved-surface auxiliary display 143 in the second color.

**[0108]** A user is able to recognize, for example, that his/her finger covers a part of the lens of the second camera module 113 based on the color of an auxiliary region 20 displayed in the curved-surface auxiliary display 143, move the finger to another place, and then perform a photographing operation. In response to a photographing command being received, the photographing apparatus may photograph images or compose photographed images while no foreign substance exists on the first and second camera modules 111, 113.

**[0109]** FIG. 10 is a diagram illustrating an example of providing a state notification service on a plurality of camera modules in a photographing apparatus.

**[0110]** As illustrated in FIG. 7A, the photographing apparatus may determine and display the image 710 generated by the predetermined first camera module 111 among the first and second camera modules 111, 113 as a live image.

**[0111]** In this case, before receiving a photographing command, the photographing apparatus may temporarily store a plurality of images generated by the first camera module 111 in the first buffer 120 and temporarily store a plurality of images generated by the second camera module 113 in the second buffer 130.

**[0112]** As described above, while the plurality of images generated by the first and second camera modules 111, 113 are temporarily stored in the first and second buffers 120, 130, the photographing apparatus analyzes the plurality of images stored in the first and second buffers 120, 130 using, for example, at least one of the image information on each of the plurality of images stored in the first and second buffers 120, 130 and the photographing information.

**[0113]** In response to analyzing that at least one of the images stored in the second buffer 130 is an image in which an event occurred, as illustrated in FIG. 10, the photographing apparatus displays the live image in a

first region 1010 of the main display 141 and display the image in which the event occurred in a second region 1020. In addition, the photographing apparatus may display an event UI 1030 including at least one of photographing information on the live image displayed in the first region 1010 and photographing information on the image in which the event occurred displayed in the second region 1020, through the curved-surface auxiliary display 143.

**[0114]** However, this example is not limited thereto. For example, in response to at least one of the images stored in the second buffer 130 being detected as an image in which the event occurred, the photographing apparatus may display a live image in one region of a screen and display the image in which the event occurred in other region of the screen. In addition, in response to at least one of the images stored in the second buffer 130 being detected as an image in which the event occurred, the photographing apparatus may display the photographing information on the image in which the event occurred in a certain part of a region where a live image is displayed.

**[0115]** In addition, as illustrated in connection with FIGS. 8, 9A and 9B, in response to the image in which the event occurred being detected, the photographing apparatus may display a live image in the main display 141 and may display a thumbnail image or histogram information on the image in which the event occurred in the curved-surface auxiliary display 143. In this case, the photographing apparatus may display at least one of the image information and the photographing information on the image in which the event occurred in a certain region of the main display 141 while displaying the thumbnail image or histogram information on the image in which the event occurred in the curved-surface auxiliary display 143.

**[0116]** According to the above-described various examples, a user is able to perform the autofocus with respect to the second camera module 113 again based on the photographing information and then carry out a photographing operation.

**[0117]** FIG. 11 is a diagram illustrating an example of providing a state notification service on a plurality of camera modules in a photographing apparatus.

**[0118]** As illustrated in FIG. 7A, the photographing apparatus may determine and display an image 1120 generated by the predetermined first camera module 111 among the first and second camera modules 111, 113 as a live image.

**[0119]** In this case, before receiving a photographing command, the photographing apparatus may temporarily store a plurality of images generated by the first camera module 111 in the first buffer 120 and temporarily store a plurality of images generated by the second camera module 113 in the second buffer 130.

**[0120]** As described above, while the plurality of images generated by the first and second camera modules 111, 113 are temporarily stored in the first and second

buffers 120, 130, the photographing apparatus analyzes the plurality of images stored in the first and second buffers 120, 130 using, for example, at least one of the image information on each of the plurality of images stored in the first and second buffers 120, 130 and the photographing information.

**[0121]** In response to analyzing that at least one of the images stored in the second buffer 130 is an image in which an event occurred, the photographing apparatus may transmit event occurrence-related information to an adjacent terminal apparatus which is capable of performing data communication with the photographing apparatus. As illustrated, the adjacent terminal apparatus which is capable of performing data communication with the photographing apparatus may, for example, be a smart watch 1110 worn on a user's wrist.

**[0122]** In response to at least one of the images stored in the second buffer 130 being detected as the image in which the event occurred, the photographing apparatus may transmit the event occurrence-related information to the smart watch 1110. Accordingly, the smart watch 1110 may provide a state notification service on the second camera module 113 based on the event occurrence-related information received from the photographing apparatus. According to an example, the smart watch 1110 may inform that a photographing operation of the second camera module 113 may be performed abnormally through a notification service such as a vibration feedback, a message alarm feedback, a beep sound feedback, a lamp alarm feedback, etc., based on the event occurrence-related information received from the photographing apparatus.

**[0123]** Accordingly, a user is able to recognize that his/her finger covers a part of the lens of the second camera module 113 through the notification service provided through the smart watch 1110 being worn on his/her wrist, move the finger to another place, and then perform a photographing operation. In response to a photographing command being received from the user, the photographing apparatus may photograph images or compose photographed images while no foreign substance exists on the first and second camera modules 111, 113.

**[0124]** The operations of the photographing apparatus of the disclosure have been described above. Hereinafter, a description of an example method for controlling a photographing apparatus according to an example will be provided.

**[0125]** FIG. 12 is a flowchart illustrating an example method for controlling a photographing apparatus.

**[0126]** As illustrated in FIG. 12, in response to an image being generated by at least one of a plurality of camera modules (e.g., a first camera module and a second camera module), a photographing apparatus displays the generated image in a screen in operation S1210. Before receiving a command relevant to a photographing operation, the photographing apparatus stores the image generated by at least one of the first camera module and the second camera module in a buffer in operation

S1220.

**[0127]** In response to images being generated by a plurality of camera modules, the photographing apparatus displays an image generated by the first camera module among the plurality of camera modules as a live image. In addition, before receiving a command relevant to a photographing operation, the photographing apparatus temporarily stores a plurality of images generated by the first camera module in a first buffer. In addition, before receiving a command relevant to a photographing operation, the photographing apparatus temporarily stores a plurality of images generated by the second camera module in a second buffer.

**[0128]** In this case, it is desirable that the photographing apparatus temporarily stores the images generated by the first and second camera modules in the first and second buffers in a sequential order based on a time sequence. In addition, it is desirable that the photographing apparatus matches and stores at least one of image information on each image generated by the first and second camera modules and photographing information. In this case, the image information may include, for example, at least one of brightness information, histogram information, and pixel information of an image, and the photographing information may include at least one of lens position information for autofocus, phase difference information, and contrast level information in each camera module in connection with generating an image.

**[0129]** The photographing apparatus analyzes the images stored in the first and second buffers by using at least one of the image information on each image stored in the first and second buffers and the photographing information of the first and second camera modules and determines whether there is an image in which an event occurred in operation S1230. In response to at least one of the images stored in the first and second buffers being detected as an image in which the event occurred based on a determination result, the photographing apparatus provides a state notification service on a camera module relevant to the image in which the event occurred in operations S1240 and S1250.

**[0130]** In response to an event occurring in an image stored in the second buffer based on at least one of the image information of each image stored in the first and second buffers and the photographing information, the photographing apparatus provides a state notification service on the second camera module relevant to the image in which the event occurred.

**[0131]** In this case, the image in which the event occurred is an image generated by the second camera module while a part of or an entire part of the second camera module is covered with a foreign substance, such as, a finger, or an auto-focused image different from other images stored in the second buffer.

**[0132]** According to an example, in response to the image in which the event occurred being detected, the photographing apparatus converts and display a live image with respect to the image generated by the first cam-

era module to the image in which the event occurred.

**[0133]** According to another example, in response to the image in which the event occurred being detected, the photographing apparatus may display a live image with respect to the image generated by the first camera module in a first region of a screen and display an event UI with respect to the image in which the event occurred in a second region of the screen. For example, the first region may be a region displayed through a main display, and the second region may be a region displayed through a curved-surface auxiliary display extended in a certain direction from the main display.

**[0134]** For example, in response to the image in which the event occurred being detected, the photographing apparatus may display the live image with respect to the image generated by the first camera module in the first region displayed through the main display and display the image in which the event occurred, that is, the event UI with respect to the image generated by the second camera module, in the second region displayed through, for example, the curved-surface auxiliary display. In this case, the event UI may, for example, be a UI for providing a thumbnail image with respect to the image in the second buffer including the image in which the event occurred or a UI for providing histogram information on the image in the second buffer.

**[0135]** According to another example, in response to the image in which the event occurred being detected, the photographing apparatus may transmit event occurrence-related information to an adjacent terminal apparatus (not shown) which is capable of performing communication with the photographing apparatus. Accordingly, the adjacent terminal apparatus (not shown) may provide a state notification service on the second camera module based on the event occurrence-related information received from the photographing apparatus. According to an example, the adjacent terminal apparatus (not shown) may inform that a photographing operation of the second camera module may be performed abnormally through a notification service such as a vibration feedback, a message alarm feedback, a beep sound feedback, a lamp alarm feedback, etc., based on the event occurrence-related information received from the photographing apparatus.

**[0136]** According to the above-described various example, a user is able to recognize that his/her finger covers a part of or an entire part of the lens of the second camera module, move the finger to another place, and then perform a photographing operation.

**[0137]** In response to a command relevant to a photographing operation being received, the photographing apparatus photographs images or composes photographed images while no foreign substance exists on the first and second camera modules, in operation S1260.

**[0138]** A more detailed description of a method for generating a composite image from images generated by the first and second camera modules in the photographing apparatus according to an example will be provided

below.

**[0139]** FIG. 13 is a flowchart illustrating an example method for generating a composite image from images generated in a plurality of camera modules in a photographing apparatus.

**[0140]** As illustrated in FIG. 13, the photographing apparatus may receive a compositeness-related photographing command while at least one of the images stored in the first and second buffers has been detected as an image in which an event occurred. In this case, the photographing apparatus selects an image to be composed from among the images stored in the first and second buffers, excluding the image in which the event occurred, in operation S1310. In response to one of the images stored in the second buffer being detected as the image in which the event occurred, the photographing apparatus selects an image adjacent to the image being detected as the image in which the event occurred as an image to be composed.

**[0141]** In response to the image to be composed being selected, the photographing apparatus may detect an occlusion region based on parallax between the image stored in the first buffer at a point of time when the composite command was received and the image selected from the second buffer, in operation S1320. The photographing apparatus determines whether an amount of the detected occlusion region is greater than a predetermined critical value, in operation S1330. In response to determining that the detected amount of the occlusion region is greater than the predetermined critical value, the photographing apparatus selects one image from among the images stored in the first buffer at the point of time when the composite command was received and the image selected from the second buffer and displays the selected image, in operation S1340.

**[0142]** In response to determining that the detected amount of the occlusion region is less than the predetermined critical value, the photographing apparatus determines whether it is possible to generate a composite image based on focusing information on each of the image stored in the first buffer at the point of time when the compositeness-related user command was received and the image selected from the second buffer and close-up photographing information corresponding to a user command, in operation S1350. In this case, the first camera module may include a wide-angle lens, and the second camera module may include a telephoto lens. Accordingly, a photographable focusing distance may be applied differently to the first camera module and the second camera module according to the characteristic of the lens of each module.

**[0143]** Accordingly, the photographing apparatus may determine whether to generate a composite image based on the focusing information on each of the image stored in the first buffer at the point of time when the composite command was received and the image selected from the second buffer and the close-up photographing information corresponding to the command. In response to de-

termining that a composing operation with respect to the image stored in the first buffer at the point of time when the compositeness-related user command was received and the image selected from the second buffer is available, the photographing apparatus generates a composite image from the two images and displays the composite image, in operations S1360 and S1370.

**[0144]** In response to determining that the composing operation is unavailable, the photographing apparatus selects one of the images stored in the first buffer at the point of time when the composite command was received and the image selected from the second buffer based on the above-described operation S1340 and displays the selected image.

**[0145]** The photographing apparatus and method for controlling the same according to various example embodiments described above may be implemented in a program provided to the display apparatus. For example, the program including the portable terminal apparatus and control method may be stored and provided in a non-transitory computer readable medium.

**[0146]** The non-transitory computer readable medium may include a machine-readable medium semi-permanently storing the data. For example, various applications or programs described above may be stored and provided in the non-transitory computer readable medium such as a compact disc (CD), a digital versatile disk (DVD), a hard disk, a Blu-ray disk, a universal serial bus (USB), a memory card, a read-only memory (ROM), or the like.

**[0147]** As above, various examples have been illustrated and described. The foregoing examples and advantages are merely exemplary and are not to be construed as limiting the disclosure. The teaching can be readily applied to other types of devices. Also, the description of the examples is intended to be illustrative, and not to limit the scope of the claims, and many alternatives, modifications, and variations within the scope of the appended claims will be apparent to those skilled in the art.

## Claims

1. A photographing apparatus comprising:

a plurality of camera modules (10, 20, 111, 113) situated on a same side of the photographing apparatus and configured to generate images at the same timing;

a first buffer (120) configured to temporarily store in a sequential order a plurality of images generated by a first camera module (111) among the plurality of camera modules before a photographing command is received;

a second buffer (130) configured to temporarily store in a sequential order a plurality of images generated by a second camera module (113) among the plurality of camera modules before

a photographing command is received;  
 a display (140) configured to display an image generated by the first camera module as a live image; and  
 a controller (150) configured to analyze the images stored in the first buffer and the second buffer using at least one of image information of each image stored in the first buffer and the second buffer and photographing information of the plurality of camera modules in order to detect the occurrence of an event comprising an obstruction by a foreign object of the second camera module, and in response to the detection of an event occurring in at least one of the plurality of images stored in the second buffer, to control the display to provide a state notification service on the second camera module;  
 in response to a photographing command being received from a user, the controller (150) is configured to generate a composite image from the images stored in the first buffer and the second buffer and to control the display (140) to display the generated composite image;  
 wherein if the photographing command is received while at least one of the images stored in the second buffer has been detected as an image in which an event occurred the controller (150) is configured to extract the image stored in the second buffer immediately before the image in which the event occurred and to generate the composite image from the image stored at the point of time when the photographing command is received among the images stored in the first buffer and the image extracted from the second buffer and otherwise the controller is configured to generate the composite image from the images stored at the point of time when the photographing command is received among the images stored in the first buffer and the second buffer.

2. The apparatus as claimed in claim 1, wherein the controller (150) is configured to control the display (140) to convert and display the image in which the event occurred as the live image in order to provide the state notification service on the second camera module by the display.

3. The apparatus as claimed in claim 1, wherein the display (140) comprises:

a main display (141); and  
 a curved-surface auxiliary display (143) configured to be extended from the main display in a certain direction,  
 wherein the controller is configured to control the display to display the live image in the main display and to display an event User Interface

(UI) with respect to the image in which the event occurred in the curved-surface auxiliary display in order to provide the state notification service on the second camera module by the display.

4. The apparatus as claimed in claim 1, wherein the image information comprises at least one of: brightness information, histogram information, and pixel information of an image,

wherein the photographing information comprises at least one of: lens position information for autofocus, phase difference information, and contrast level information of at least one of the plurality of camera modules, and wherein the first buffer (120) and the second buffer (130) match and store the image information of each image and the photographing information.

5. The apparatus as claimed in claim 1, wherein the controller (150) is configured to detect an occlusion region based on a parallax of each of the images stored in the first buffer (120) and the second buffer (130) and to determine whether to generate the composite image based on whether a detected amount of the occlusion region is greater than a predetermined critical value.

6. The apparatus as claimed in claim 1, wherein the first camera module (111) comprises a wide-angle lens, and the second camera module (113) comprises a telephoto lens, and wherein the controller is configured to determine whether to generate the composite image based on focusing information of each of the first camera module (111) and the second camera module (113) and close-up photographing information corresponding to a command.

7. A method for controlling a photographing apparatus having a plurality of camera modules situated on a same side of the photographing apparatus and configured to generate images at the same timing, comprising:

displaying (S1210) an image generated by a first camera module among the plurality of camera modules as a live image;  
 storing (S1220) temporarily in a sequential order images generated by the first camera module in a first buffer and storing images generated by a second camera module among the plurality of camera modules in a second buffer before a photographing command is received;  
 analyzing (S 1230) the images stored in the first buffer and the second buffer using at least one of: image information of each image stored in

- the first buffer and the second buffer and photographing information of the plurality of camera modules in order to detect the occurrence of an event comprising an obstruction by a foreign object of the second camera module;
- providing (S 1250), in response to the detection of an event occurring (S 1240) in at least one of the plurality of images stored in the second buffer, a state notification service on the second camera module;
- generating (S 1260) in response to a photographing command being received from a user a composite image from among the images stored in the first and second buffers; and displaying (S1370) the generated composite image,
- wherein
- extracting the image stored in the second buffer immediately before the image in which the event occurred, if the photographing command is received while at least one of the images stored in the second buffer has been detected as an image in which an event occurred, and generating the composite image from the image stored at the point of time when the photographing command is received among the images stored in the first buffer and the image extracted from the second buffer, and otherwise generating the composite image from the images stored at the point of time when the photographing command is received among the images stored in the first buffer and the second buffer.
8. The method as claimed in claim 7, wherein in response to an image in which the event occurred being detected, the providing comprises converting and displaying the image in which the event occurred as the live image in order to provide the state notification service on the second camera module by the display.
9. The method as claimed in claim 7, wherein in response to the image in which the event occurred being detected, the providing comprises displaying the live image in a main display and displaying an event User Interface UI with respect to the image in which the event occurred in a curved-surface auxiliary display extending from the main display in order to provide the state notification service on the second camera module by the display.
10. The method as claimed in claim 7, wherein the image information comprises at least one of: brightness information, histogram information, and pixel information of an image,

wherein the photographing information compris-

es at least one of: lens position information for autofocus, phase difference information, and contrast level information of at least one of the plurality of camera modules, and wherein the first buffer and the second buffer match and store the image information of each image and the photographing information.

## 10 Patentansprüche

### 1. Fotografiervorrichtung, die Folgendes umfasst:

eine Vielzahl von Kameramodulen (10, 20, 111, 113), die sich auf der selben Seite der Fotografiervorrichtung befinden und so konfiguriert sind, dass sie zur gleichen Zeit Bilder erzeugen;

einen ersten Puffer (120), der so konfiguriert ist, dass er eine Vielzahl von Bildern, die von einem ersten Kameramodul (111) aus der Vielzahl von Kameramodulen erzeugt werden, in einer sequentiellen Reihenfolge vorübergehend speichert, bevor ein Fotografierbefehl empfangen wird;

einen zweiten Puffer (130), der so konfiguriert ist, dass er eine Vielzahl von Bildern, die von einem zweiten Kameramodul (113) aus der Vielzahl von Kameramodulen erzeugt werden, in einer sequentiellen Reihenfolge vorübergehend speichert, bevor ein Fotografierbefehl empfangen wird;

eine Anzeige (140), die so konfiguriert ist, dass sie ein von dem ersten Kameramodul erzeugtes Bild als ein Live-Bild anzeigt; und

eine Steuerung (150), die konfiguriert ist, um die in dem ersten Puffer und dem zweiten Puffer gespeicherten Bilder unter Verwendung von Bildinformationen jedes in dem ersten Puffer und dem zweiten Puffer gespeicherten Bildes und/oder von Fotografierinformationen der Vielzahl von Kameramodulen zu analysieren, um das Auftreten eines Ereignisses zu erfassen, das eine Behinderung des zweiten Kameramoduls durch ein Fremdobjekt umfasst, und um als Reaktion auf die Erfassung eines Ereignisses, das in mindestens einem aus der Vielzahl von Bildern auftritt, die in dem zweiten Puffer gespeichert sind, um die Anzeige so zu steuern, dass sie einen Statusbenachrichtigungsdienst in Bezug auf das zweite Kameramodul bereitstellt;

wobei als Reaktion auf einen von einem Benutzer empfangenen Fotografierbefehl die Steuerung (150) konfiguriert ist, um ein zusammengesetztes Bild aus den in dem ersten Puffer und dem zweiten Puffer gespeicherten Bildern zu erzeugen und die Anzeige (140) so zu steuern, dass sie das erzeugte zusammengesetzte Bild

- anzeigt;  
wobei, wenn der Fotografierbefehl empfangen wird, während mindestens eines der in dem zweiten Puffer gespeicherten Bilder als ein Bild erkannt wurde, in dem ein Ereignis aufgetreten ist, die Steuerung (150) konfiguriert ist, um das Bild zu extrahieren, das in dem zweiten Puffer unmittelbar vor dem Bild gespeichert wurde, in dem das Ereignis aufgetreten ist, und um das zusammengesetzte Bild aus dem Bild unter den in dem ersten Puffer gespeicherten Bildern, das zu dem Zeitpunkt, zu dem der Fotografierbefehl empfangen wurde, gespeichert wurde, und dem aus dem zweiten Puffer extrahierten Bild zu erzeugen, und wobei die Steuerung andernfalls konfiguriert ist, um das zusammengesetzte Bild aus den Bildern zu erzeugen, die zu dem Zeitpunkt, zu dem der Fotografierbefehl empfangen wurde, in dem ersten Puffer und dem zweiten Puffer gespeichert wurden.
2. Vorrichtung nach Anspruch 1, wobei die Steuerung (150) dazu konfiguriert ist, die Anzeige so zu steuern, dass sie das Bild, in dem das Ereignis aufgetreten ist, als das Live-Bild umwandelt und anzeigt, um den Statusbenachrichtigungsdienst in Bezug auf das zweite Kameramodul durch die Anzeige bereitzustellen.
3. Vorrichtung nach Anspruch 1, wobei die Anzeige (140) Folgendes umfasst:
- eine Hauptanzeige (141); und
  - eine Hilfsanzeige (143) mit gekrümmter Oberfläche, die so konfiguriert ist, dass sie sich von der Hauptanzeige in eine gewisse Richtung erstreckt,
  - wobei die Steuerung dazu konfiguriert ist, die Anzeige so zu steuern, dass sie das Live-Bild in der Hauptanzeige anzeigt, und dazu, eine Ereignis-Benutzerschnittstelle (UI) in Bezug auf das Bild, in dem das Ereignis aufgetreten ist, in der Hilfsanzeige mit gekrümmter Oberfläche anzuzeigen, um den Statusbenachrichtigungsdienst in Bezug auf das zweite Kameramodul durch die Anzeige bereitzustellen.
4. Vorrichtung nach Anspruch 1, wobei die Bildinformationen mindestens eine der Folgenden umfassen: Helligkeitsinformationen, Histogramminformationen und Pixelinformationen eines Bildes, wobei die Fotografierinformationen mindestens eine der Folgenden umfassen: Objektivpositionsinformationen für Autofokus, Phasendifferenzinformationen und Kontrastpegelinformationen von mindestens einem aus der Vielzahl von Kameramodulen, und wobei der erste Puffer (120) und der zweite Puffer (130) die Bildinformationen jedes Bildes und die Fotografierinformationen abgleichen und speichern.
5. Vorrichtung nach Anspruch 1, wobei die Steuerung (150) so konfiguriert ist, dass sie einen Okklusionsbereich basierend auf einer Parallaxe jedes der in dem ersten Puffer (120) und dem zweiten Puffer (130) gespeicherten Bilder erfasst, und dass sie bestimmt, ob das zusammengesetzte Bild basierend darauf erzeugt werden soll, ob eine erfasste Menge des Okklusionsbereichs größer als ein vorbestimmter kritischer Wert ist.
6. Vorrichtung nach Anspruch 1, wobei das erste Kameramodul (111) ein Weitwinkelobjektiv umfasst und das zweite Kameramodul (113) ein Teleobjektiv umfasst, und wobei die Steuerung konfiguriert ist, um zu bestimmen, ob das zusammengesetzte Bild basierend auf Fokussierungsinformationen sowohl des ersten Kameramoduls (111) als auch des zweiten Kameramoduls (113) sowie auf Nahaufnahmenfotografierinformationen entsprechend einem Befehl erzeugt werden soll.
7. Verfahren zum Steuern einer Fotografiervorrichtung mit einer Vielzahl von Kameramodulen, die sich auf der selben Seite der Fotografiervorrichtung befinden und so konfiguriert sind, dass sie zur gleichen Zeit Bilder erzeugen, umfassend:
- Anzeigen (S1210) eines Bildes, das von einem ersten Kameramodul aus der Vielzahl von Kameramodulen erzeugt wird, als ein Live-Bild;
  - vorübergehendes Speichern (S 1220) von durch das erste Kameramodul erzeugten Bildern in einer sequentiellen Reihenfolge in einem ersten Puffer und Speichern von durch ein zweites Kameramodul aus der Vielzahl von Kameramodulen erzeugten Bildern in einem zweiten Puffer, bevor ein Fotografierbefehl empfangen wird;
  - Analysieren (S 1230) der in dem ersten Puffer und dem zweiten Puffer gespeicherten Bilder unter Verwendung von Bildinformationen jedes in dem ersten Puffer und dem zweiten Puffer gespeicherten Bildes und/oder von Fotografierinformationen der Vielzahl von Kameramodulen, um das Eintreten eines Ereignisses zu erfassen, das eine Behinderung des zweiten Kameramoduls durch ein Fremdobjekt umfasst;
  - Bereitstellen (S1250) eines Statusbenachrichtigungsdienstes in Bezug auf das zweite Kameramodul als Reaktion auf die Erfassung eines Ereignisses, das in mindestens einem aus der Vielzahl von Bildern auftritt (S1240), die in dem zweiten Puffer gespeichert sind;
  - Erzeugen (S 1260) eines zusammengesetzten Bildes aus den Bildern, die in den ersten und zweiten Puffern gespeichert sind, als Reaktion

- auf einen von einem Benutzer empfangenen Fotografierbefehl; und Anzeigen (S1370) des erzeugten zusammengesetzten Bildes, wobei
- Extrahieren des Bildes, das in dem zweiten Puffer unmittelbar vor dem Bild gespeichert wurde, in dem das Ereignis aufgetreten ist, wenn der Fotografierbefehl empfangen wird, während mindestens eines der in dem zweiten Puffer gespeicherten Bilder als ein Bild erkannt wurde, in dem ein Ereignis aufgetreten ist, und Erzeugen des zusammengesetzten Bildes aus dem Bild unter den in dem ersten Puffer gespeicherten Bildern, das zu dem Zeitpunkt, zu dem der Fotografierbefehl empfangen wurde, gespeichert wurde, und dem aus dem zweiten Puffer extrahierten Bild, und andernfalls Erzeugen des zusammengesetzten Bildes aus den Bildern, die zu dem Zeitpunkt, zu dem der Fotografierbefehl empfangen wurde, in dem ersten Puffer und dem zweiten Puffer gespeichert wurden.
8. Verfahren nach Anspruch 7, wobei als Reaktion auf die Erfassung eines Bildes, in dem das Ereignis aufgetreten ist, das Bereitstellen Folgendes umfasst: Umwandeln und Anzeigen des Bildes, in dem das Ereignis aufgetreten ist, als das Live-Bild, um den Statusbenachrichtigungsdienst in Bezug auf das zweite Kameramodul durch die Anzeige bereitzustellen.
9. Verfahren nach Anspruch 7, wobei als Reaktion auf die Erfassung eines Bildes, in dem das Ereignis aufgetreten ist, das Bereitstellen Folgendes umfasst: Anzeigen des Live-Bildes in einer Hauptanzeige und Anzeigen einer Ereignis-Benutzerschnittstelle (UI) in Bezug auf das Bild, in dem das Ereignis aufgetreten ist, in einer Hilfsanzeige mit gekrümmter Oberfläche, die sich von der Hauptanzeige erstreckt, um den Statusbenachrichtigungsdienst in Bezug auf das zweite Kameramodul durch die Anzeige bereitzustellen.
10. Verfahren nach Anspruch 7, wobei die Bildinformationen mindestens eine der Folgenden umfassen: Helligkeitsinformationen, Histogramminformationen und Pixelinformationen eines Bildes, wobei die Fotografierinformationen mindestens eine der Folgenden umfassen: Objektivpositionsinformationen für Autofokus, Phasendifferenzinformationen und Kontrastpegelinformationen von mindestens einem aus der Vielzahl von Kameramodulen, und wobei der erste Puffer und der zweite Puffer die Bildinformationen jedes Bildes und die Fotografierinformationen abgleichen und speichern.

## Revendications

### 1. Appareil photographique comprenant :

- 5 une pluralité de modules photographiques (10, 20, 111, 113) situés sur un même côté de l'appareil photographique et conçus pour générer des images au même instant ;
- 10 une première mémoire tampon (120) conçue pour enregistrer temporairement, selon un ordre séquentiel, une pluralité d'images générées par un premier module photographique (111) parmi la pluralité de modules photographiques avant qu'une commande de photographie n'ait été reçue ;
- 15 une deuxième mémoire tampon (130) conçue pour enregistrer temporairement, selon un ordre séquentiel, une pluralité d'images générées par un deuxième module photographique (113) parmi la pluralité de modules photographiques avant qu'une commande de photographie n'ait été reçue ;
- 20 un écran (140) conçu pour afficher une image générée par le premier module photographique sous la forme d'une image en direct ; et
- 25 un organe de commande (150) conçu pour analyser les images enregistrées dans la première mémoire tampon et la deuxième mémoire tampon au moyen d'informations d'image relatives à chaque image enregistrée dans la première mémoire tampon et la deuxième mémoire tampon et/ou d'informations photographiques de la pluralité de modules photographiques afin de détecter la survenue d'un événement comprenant une obstruction du deuxième module photographique par un objet étranger, et en réaction à la détection d'un événement survenant dans au moins une image de la pluralité d'images enregistrées dans la deuxième mémoire tampon, pour commander l'écran de façon qu'il fournisse un service de notification d'état relatif au deuxième module photographique ;
- 30 en réaction à la réception d'une commande de photographie en provenance d'un utilisateur, l'organe de commande (150) est conçu pour générer une image composite à partir des images enregistrées dans la première mémoire tampon et la deuxième mémoire tampon et pour commander l'écran (140) pour afficher l'image composite générée ;
- 35 étant entendu que si la commande de photographie est reçue pendant qu'au moins une des images enregistrées dans la deuxième mémoire tampon a été détectée comme étant une image dans laquelle est survenu un événement, l'organe de commande (150) est conçu pour extraire l'image enregistrée dans la deuxième mémoire tampon immédiatement avant l'image dans
- 40
- 45
- 50
- 55

- laquelle est survenu l'événement et pour générer l'image composite à partir de celle des images enregistrées dans la première mémoire tampon qui a été enregistrée au moment auquel la commande de photographie a été reçue et de l'image extraite de la deuxième mémoire tampon, et autrement l'organe de commande est conçu pour générer l'image composite à partir de celles des images enregistrées dans la première mémoire tampon et la deuxième mémoire tampon qui ont été enregistrées au moment auquel la commande de photographie a été reçue.
2. Appareil selon la revendication 1, dans lequel l'organe de commande (150) est conçu pour commander l'écran (140) de façon qu'il convertisse et affiche l'image dans laquelle est survenu l'événement sous la forme de l'image en direct pour que l'écran puisse fournir le service de notification d'état relatif au deuxième module photographique.
3. Appareil selon la revendication 1, dans lequel l'écran (140) comprend :
- un écran principal (141), et
  - un écran auxiliaire à surface incurvée (143) conçu pour s'étendre à partir de l'écran principal selon une certaine direction ;
  - ledit organe de commande étant conçu pour commander l'écran de façon qu'il affiche l'image en direct sur l'écran principal et pour afficher, sur l'écran auxiliaire à surface incurvée, une interface utilisateur (UI, user interface) relative à l'événement concernant l'image dans laquelle est survenu l'événement pour que l'écran puisse fournir le service de notification d'état relatif au deuxième module photographique.
4. Appareil selon la revendication 1, dans lequel les informations d'image comprennent des informations de luminosité, des informations d'histogramme et/ou des informations concernant les pixels d'une image,
- dans lequel les informations photographiques comprennent des informations de position d'objectif pour la mise au point automatique, des informations de déphasage et/ou des informations de niveau de contraste d'au moins un des modules photographiques, et
  - dans lequel la première mémoire tampon (120) et la deuxième mémoire tampon (130) font correspondre et enregistrent les informations d'image relatives à chaque image et les informations photographiques.
5. Appareil selon la revendication 1, dans lequel l'organe de commande (150) est conçu pour détecter
- une zone d'occlusion compte tenu de la parallaxe de chacune des images enregistrées dans la première mémoire tampon (120) et la deuxième mémoire tampon (130) et pour déterminer s'il y a lieu de générer l'image composite compte tenu du fait ou non que la quantité détectée de zone d'occlusion est supérieure à une valeur critique prédéterminée.
6. Appareil selon la revendication 1, dans lequel le premier module photographique (111) comprend un objectif grand-angulaire, et le deuxième module photographique (113) comprend un téléobjectif, et dans lequel l'organe de commande est conçu pour déterminer s'il y a lieu de générer l'image composite compte tenu d'informations de mise au point concernant le premier module photographique (111) et le deuxième module photographique (113) et d'informations de photographie rapprochée correspondant à une commande.
7. Procédé de commande d'un appareil photographique présentant une pluralité de modules photographiques situés sur un même côté de l'appareil photographique et conçus pour générer des images au même instant, comprenant :
- l'affichage (S1210) d'une image générée par un premier module photographique parmi la pluralité de modules photographiques sous la forme d'une image en direct ;
  - l'enregistrement temporaire (S 1220), dans une première mémoire tampon, selon un ordre séquentiel, d'images générées par le premier module photographique, et l'enregistrement, dans une deuxième mémoire tampon, d'images générées par un deuxième module photographique parmi la pluralité de modules photographiques avant qu'une commande de photographie n'ait été reçue ;
  - l'analyse (S 1230) des images enregistrées dans la première mémoire tampon et la deuxième mémoire tampon au moyen d'informations d'image relatives à chaque image enregistrée dans la première mémoire tampon et la deuxième mémoire tampon et/ou d'informations photographiques de la pluralité de modules photographiques afin de détecter la survenue d'un événement comprenant une obstruction du deuxième module photographique par un objet étranger ;
  - la fourniture (S1250) d'un service de notification d'état relatif au deuxième module photographique, en réaction à la détection d'un événement se produisant (S1240) dans au moins une image de la pluralité d'images enregistrées dans la deuxième mémoire tampon ;
  - la génération (S 1260) d'une image composite à partir des images enregistrées dans la première

re et la deuxième mémoire tampon, en réaction à la réception d'une commande de photographie en provenance d'un utilisateur ; et l'affichage (S1370) de l'image composite générée, 5

le procédé comprenant en outre l'extraction de l'image enregistrée dans la deuxième mémoire tampon immédiatement avant l'image dans laquelle est survenu l'événement, si la commande de photographie est reçue pendant qu'au moins une des images enregistrées dans la deuxième mémoire tampon a été détectée comme étant une image dans laquelle est survenu un événement, et 10

la génération de l'image composite à partir de celle des images enregistrées dans la première mémoire tampon qui a été enregistrée au moment auquel la commande de photographie a été reçue et de l'image extraite de la deuxième mémoire tampon, et autrement 15

la génération de l'image composite à partir de celles des images enregistrées dans la première mémoire tampon et la deuxième mémoire tampon qui ont été enregistrées au moment auquel la commande de photographie a été reçue. 20 25

dans lequel la première mémoire tampon et la deuxième mémoire tampon font correspondre et enregistrent les informations d'image relatives à chaque image et les informations photographiques.

8. Procédé selon la revendication 7, dans lequel, en réaction à la détection d'une image dans laquelle est survenu l'événement, la fourniture du service comprend la conversion et l'affichage de l'image dans laquelle est survenu l'événement sous la forme de l'image en direct pour que l'écran puisse fournir le service de notification d'état relatif au deuxième module photographique. 30 35
9. Procédé selon la revendication 7, dans lequel, en réaction à la détection d'une image dans laquelle est survenu l'événement, la fourniture du service comprend l'affichage de l'image en direct sur un écran principal et l'affichage d'une interface utilisateur (UI, user interface) relative à l'événement concernant l'image dans laquelle est survenu l'événement sur un écran auxiliaire à surface incurvée s'étendant à partir de l'écran principal pour que l'écran puisse fournir le service de notification d'état relatif au deuxième module photographique. 40 45
10. Procédé selon la revendication 7, dans lequel les informations d'image comprennent des informations de luminosité, des informations d'histogramme et/ou des informations concernant les pixels d'une image, 50
- dans lequel les informations photographiques comprennent des informations de position d'objectif pour la mise au point automatique, des informations de déphasage et/ou des informations de niveau de contraste d'au moins un des modules photographiques, et 55

[Fig. 1a]

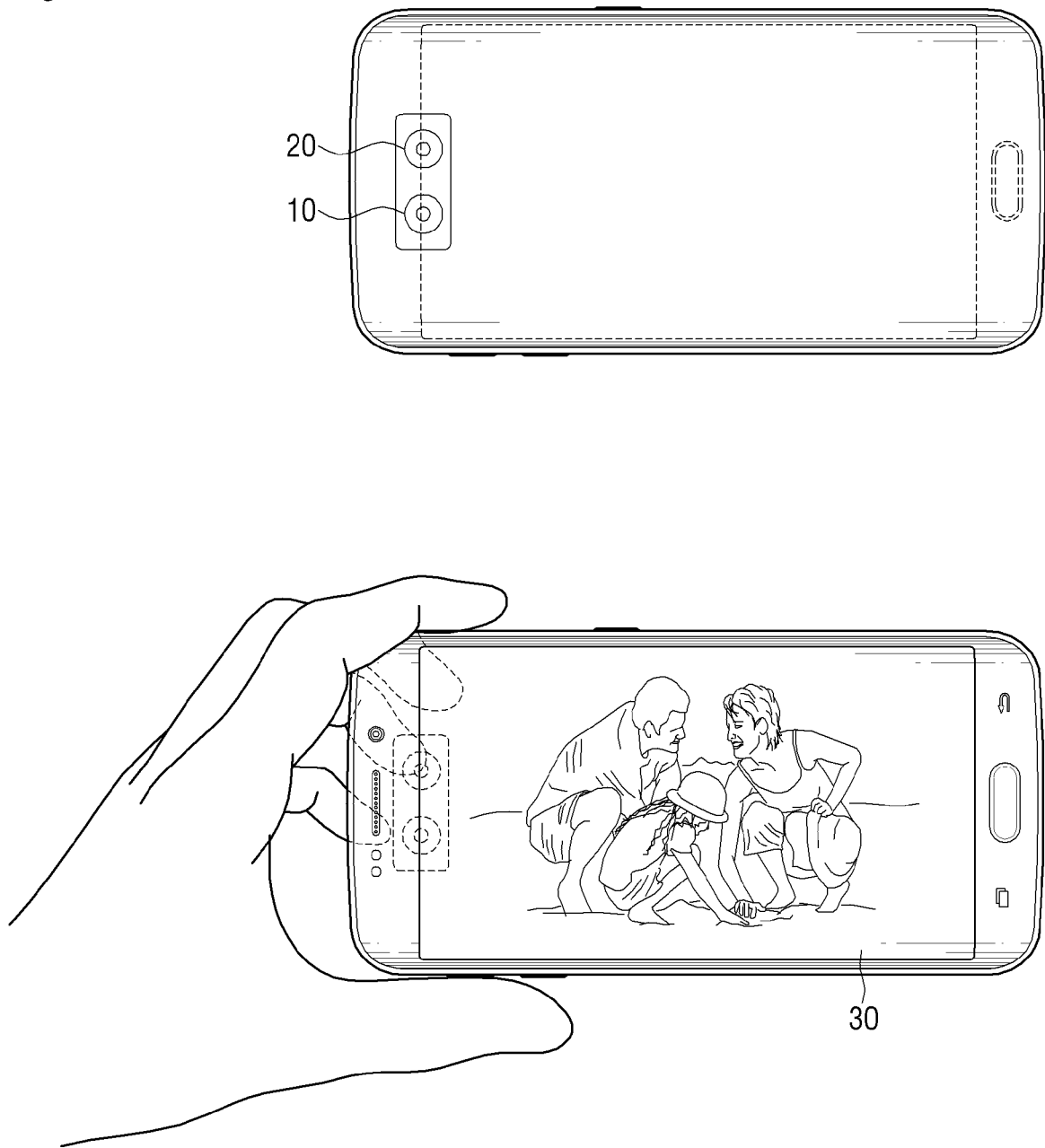

[Fig. 1b]

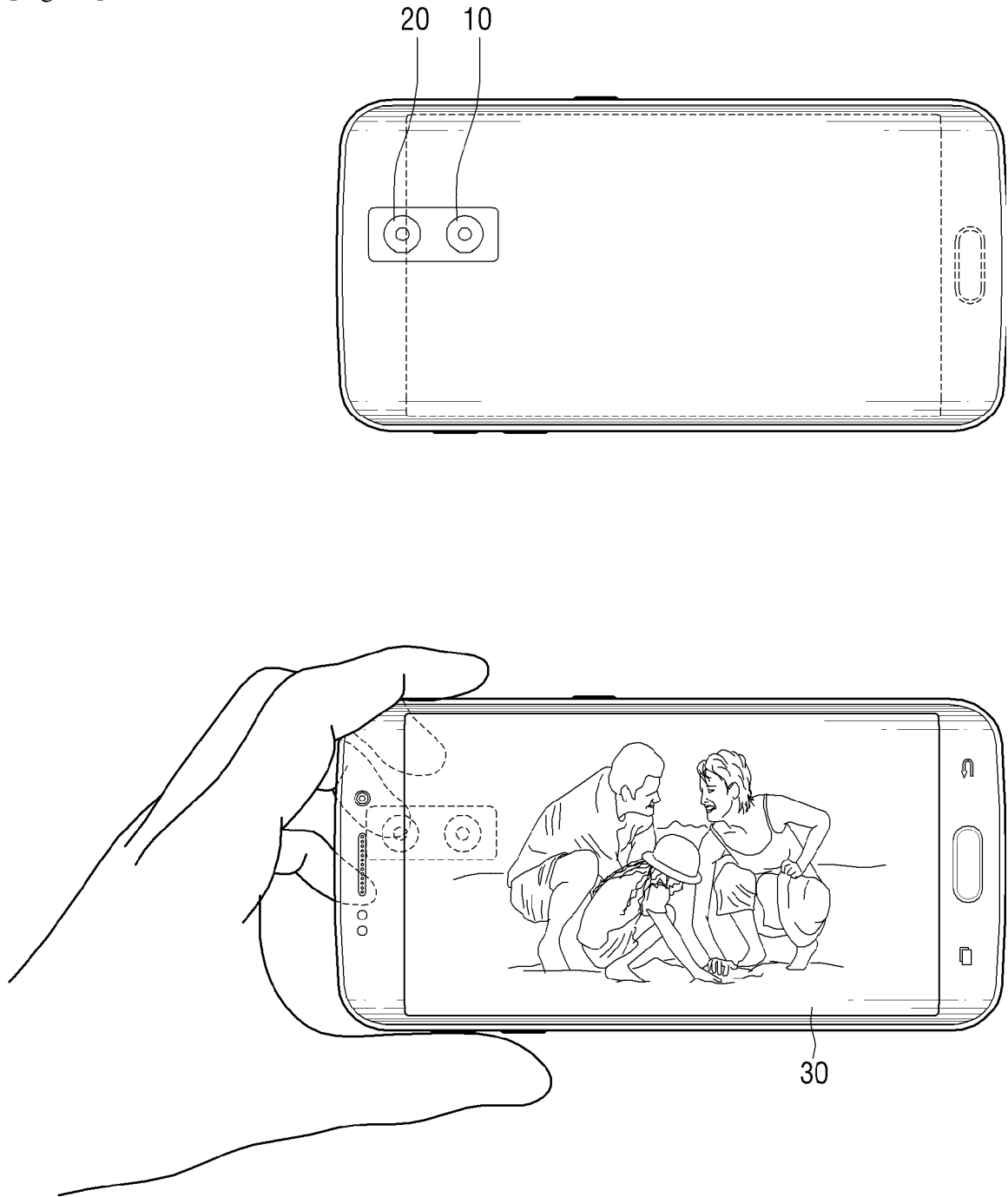

[Fig. 2]

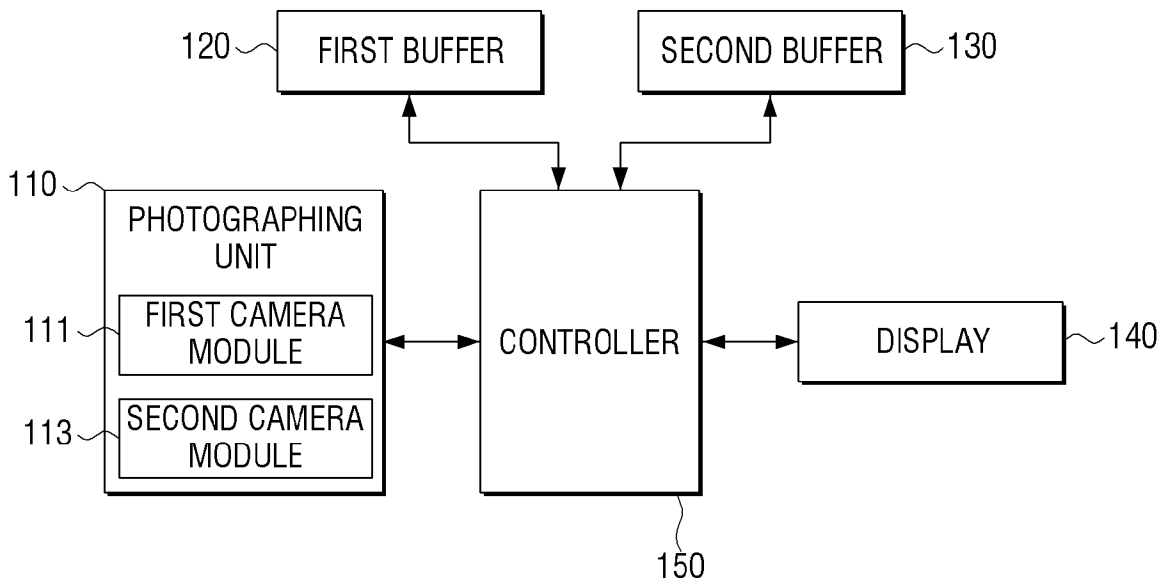

[Fig. 3]

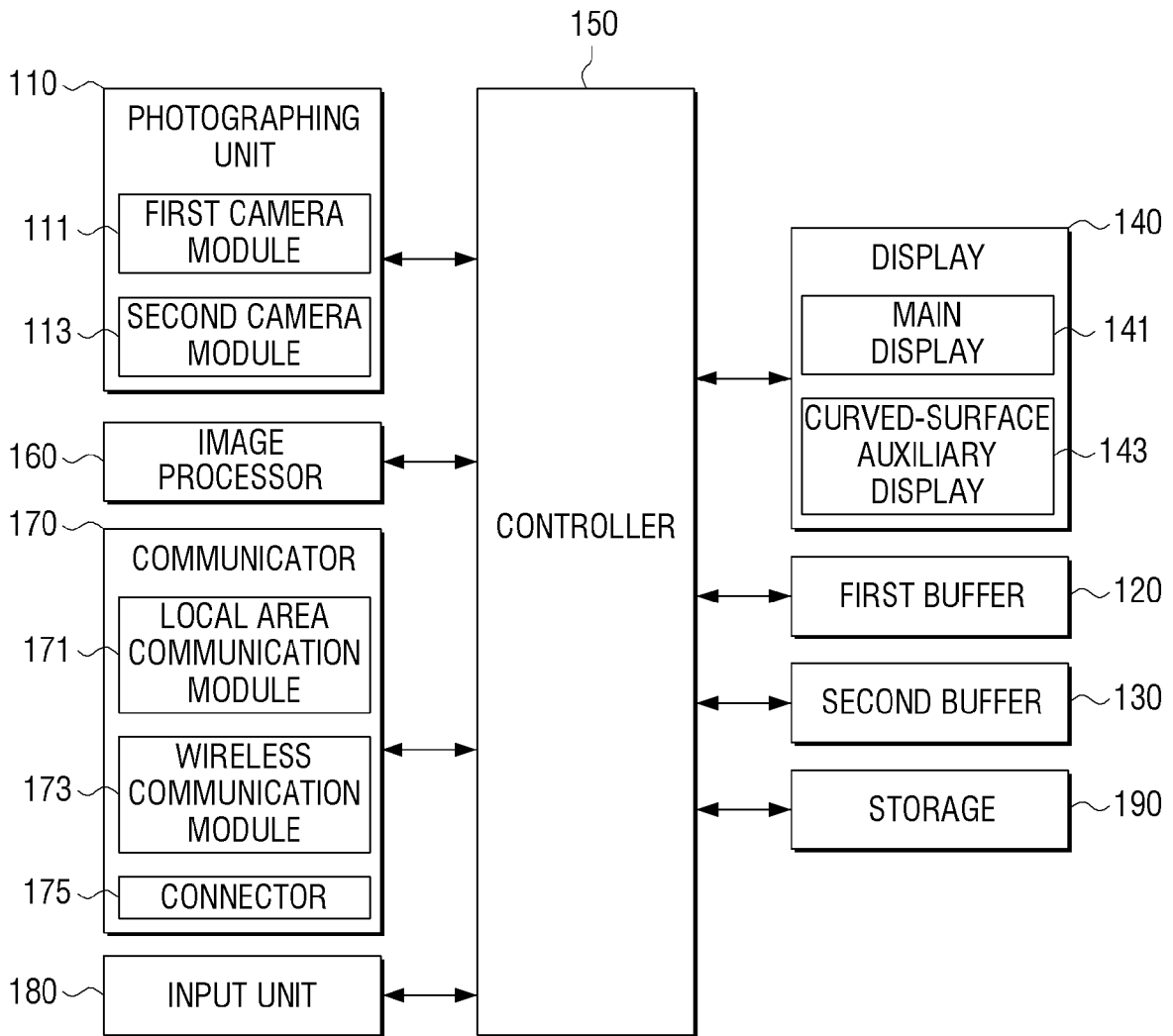

[Fig. 4]

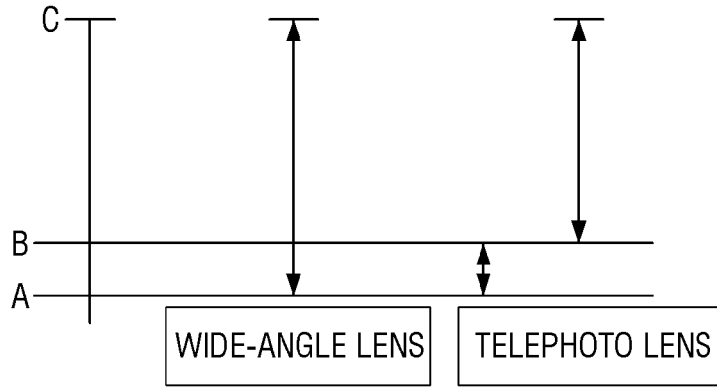

[Fig. 5a]

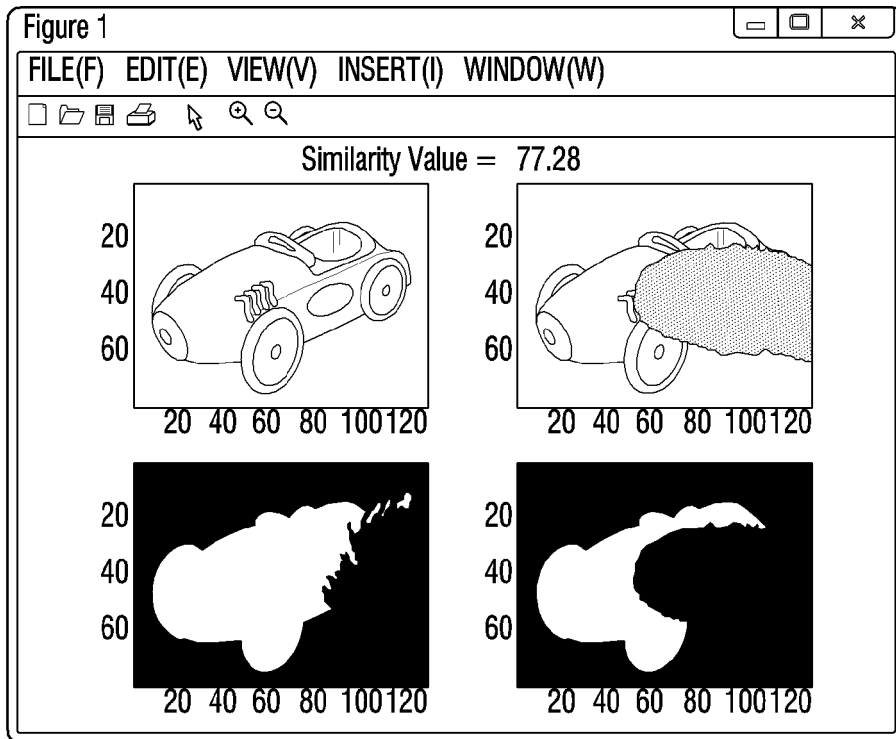

[Fig. 5b]

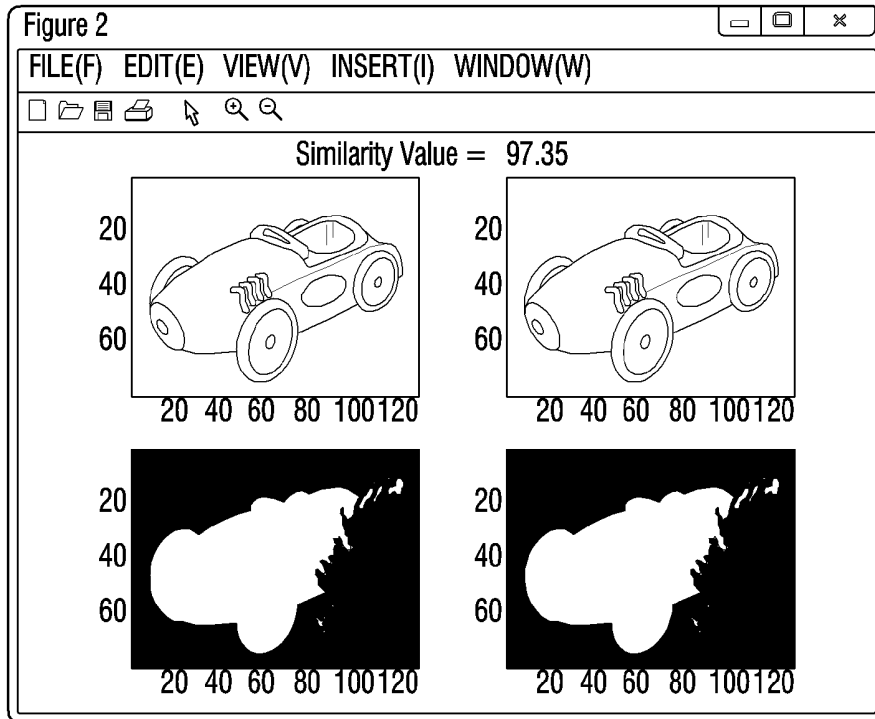

[Fig. 6]

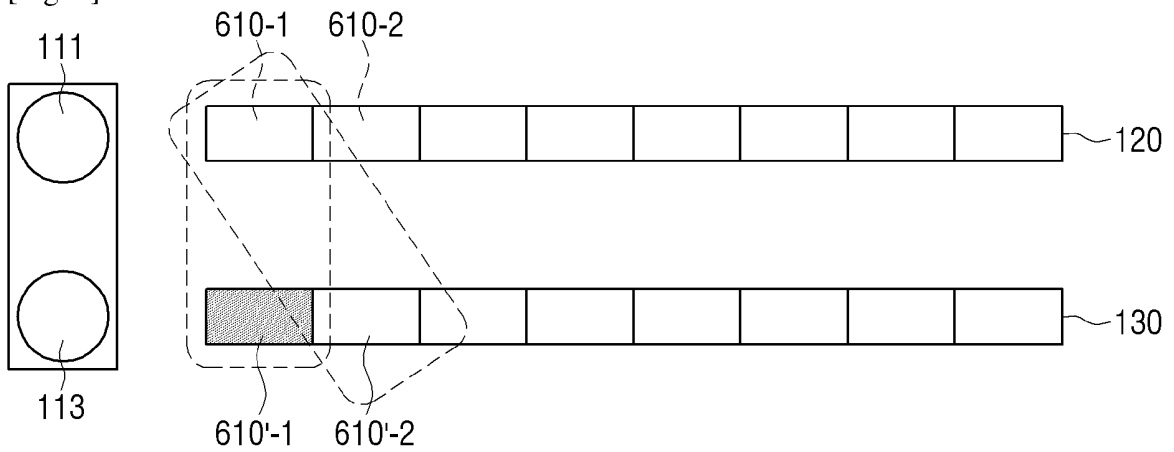

[Fig. 7a]

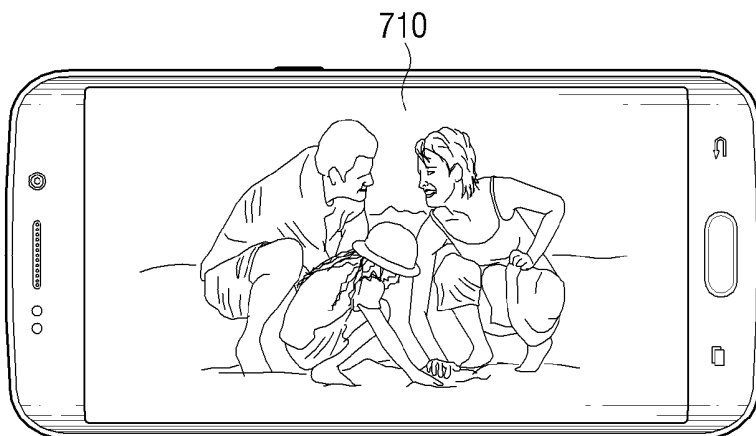

[Fig. 7b]

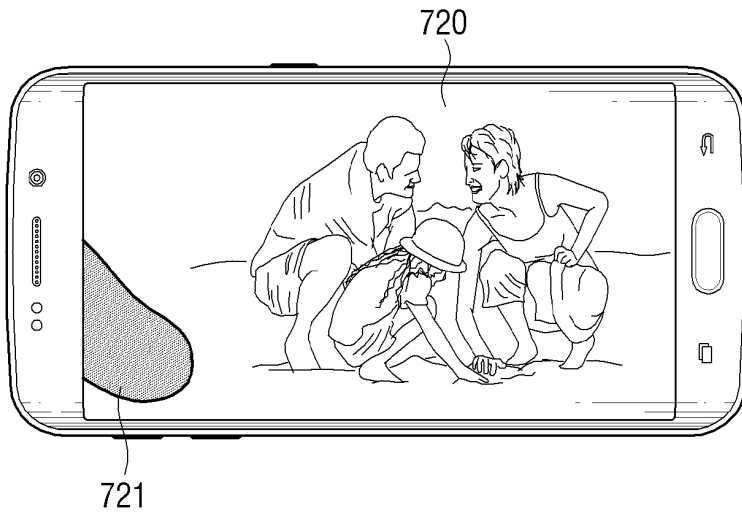

[Fig. 8]

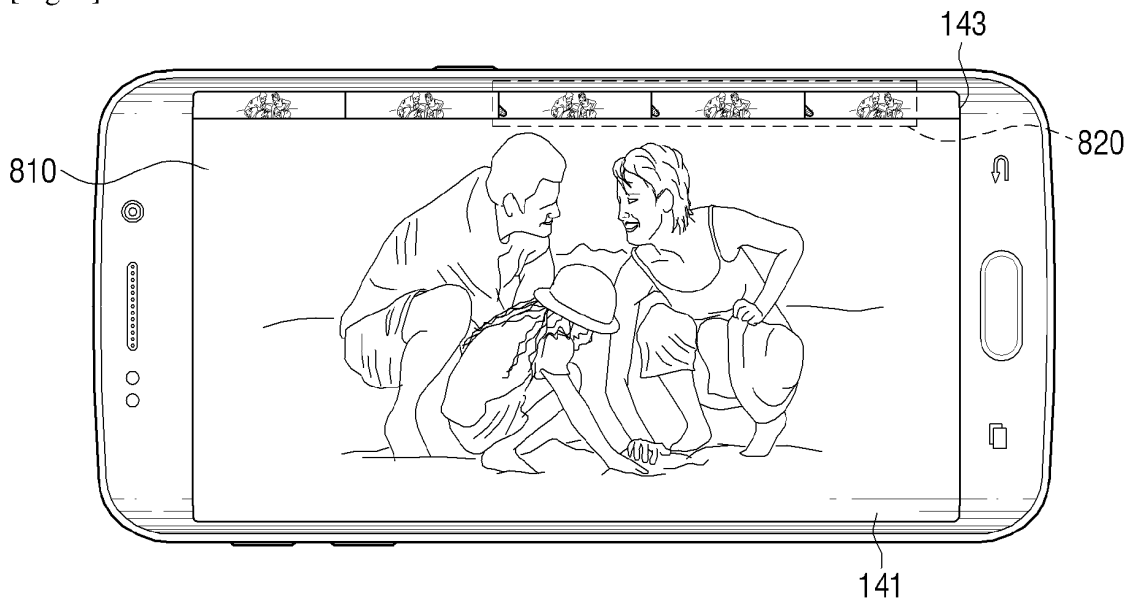

[Fig. 9a]

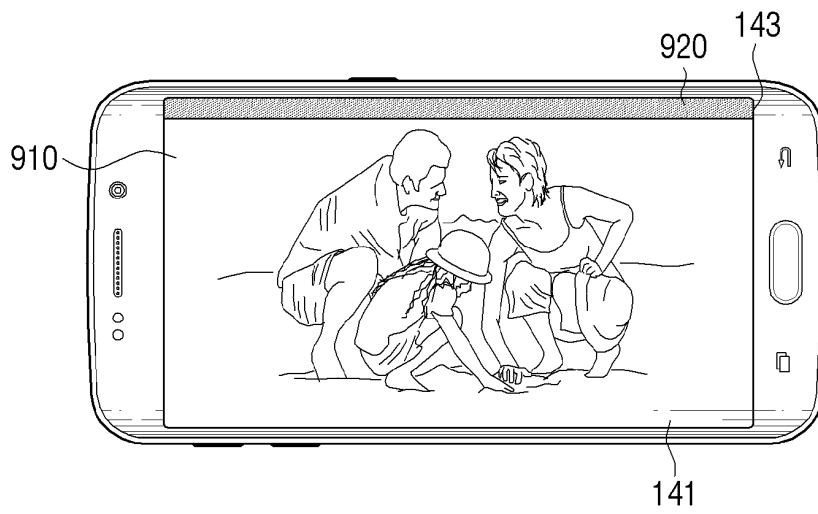

[Fig. 9b]

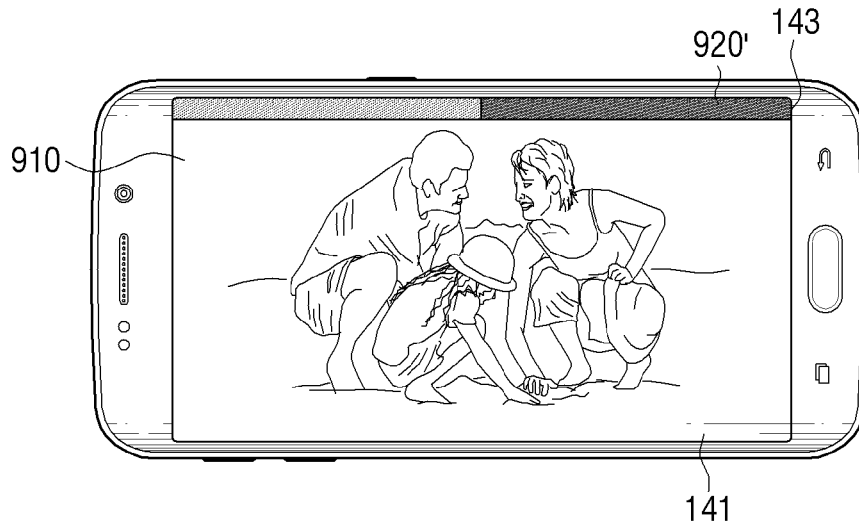

[Fig. 10]

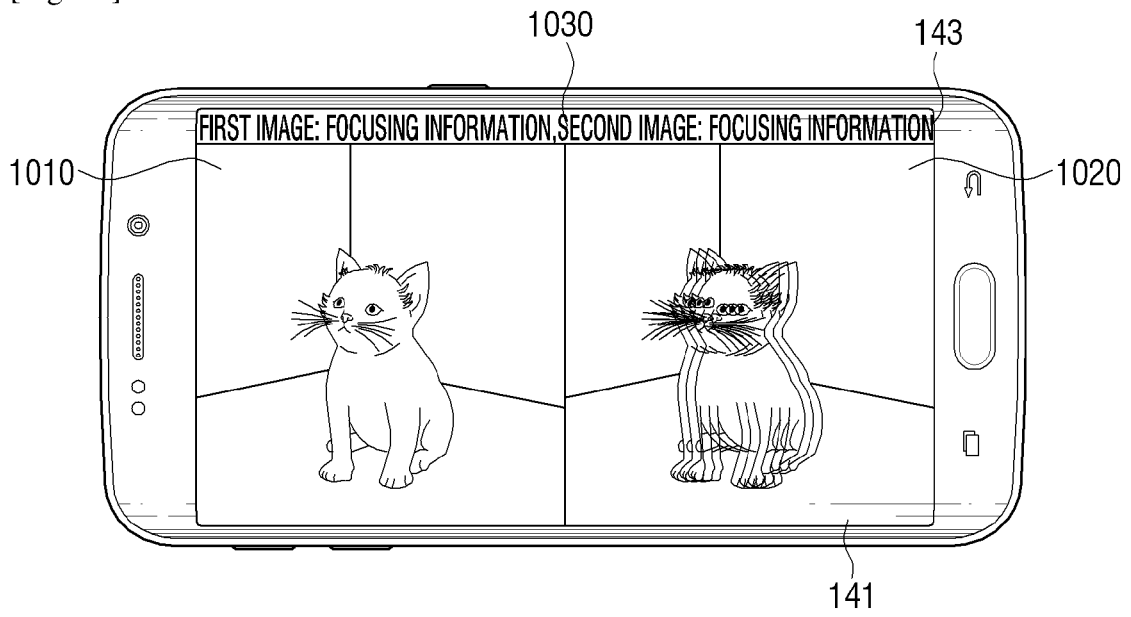

[Fig. 11]

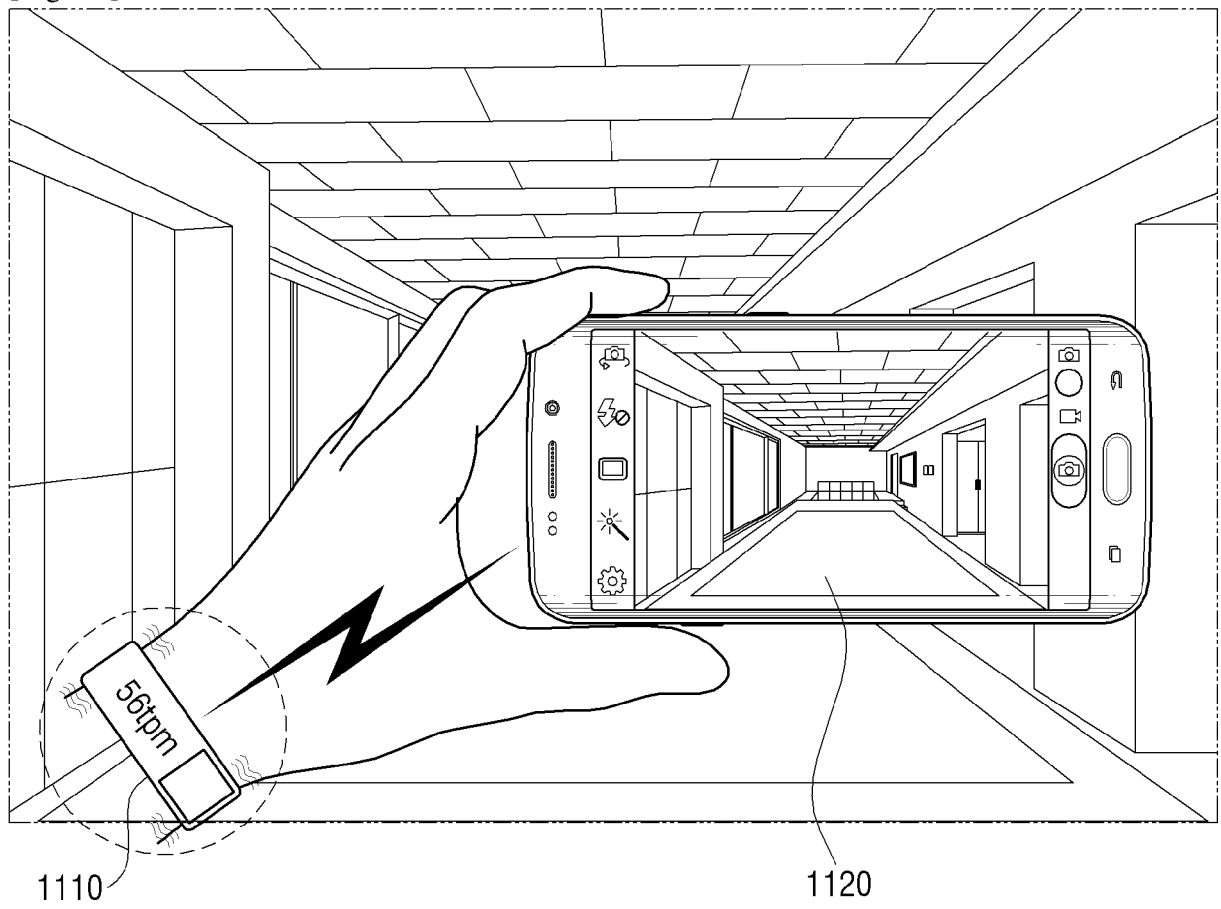

[Fig. 12]

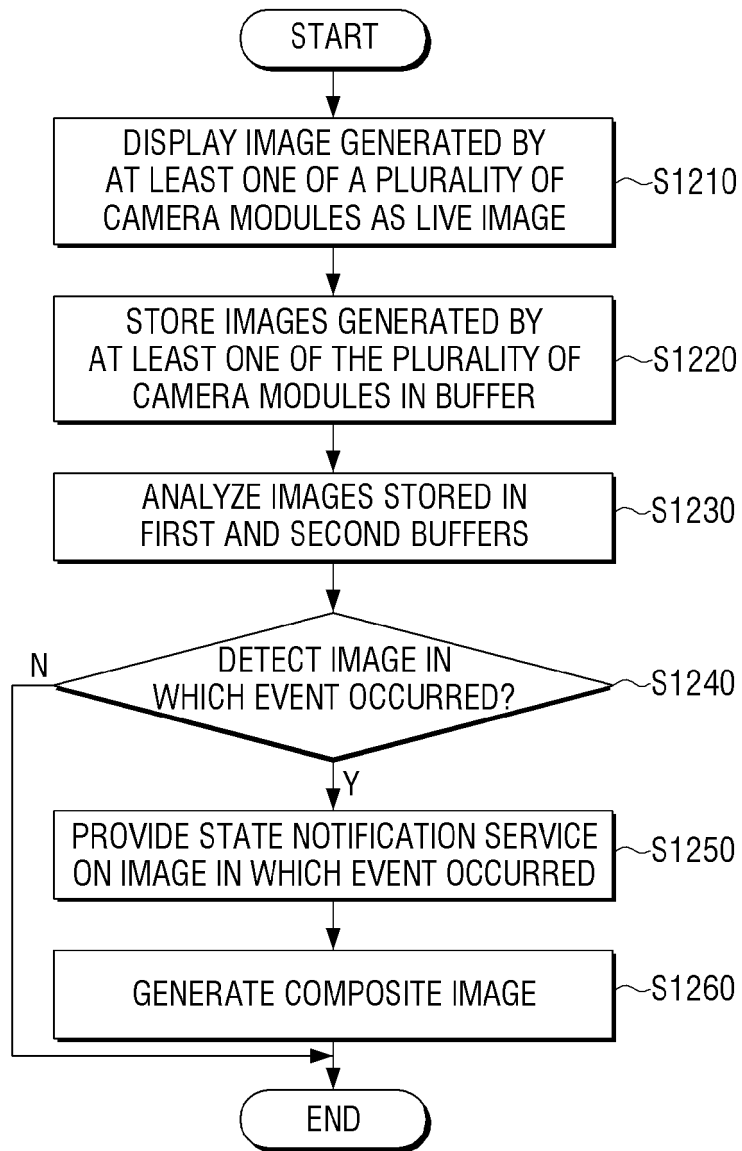

[Fig. 13]

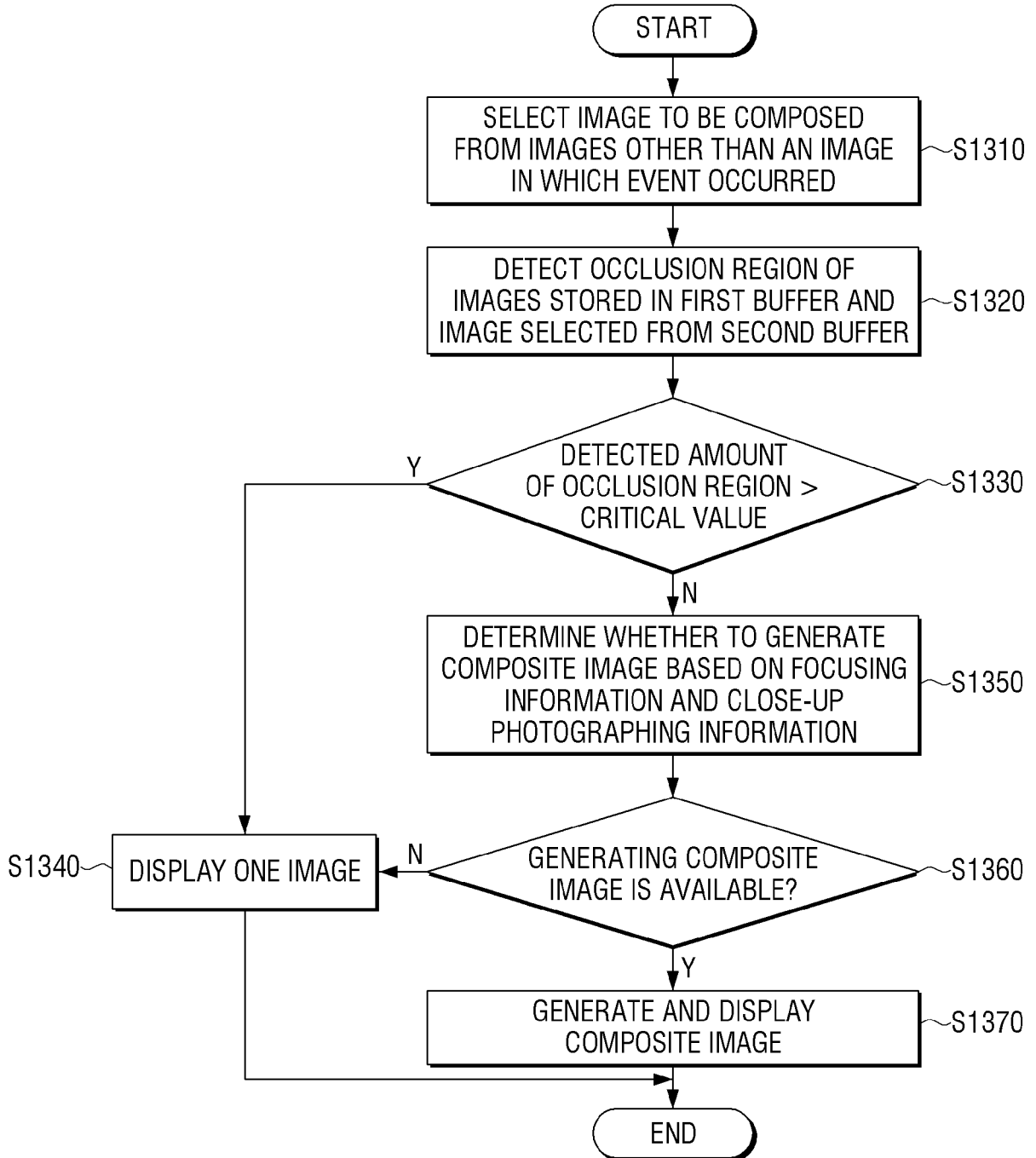

**REFERENCES CITED IN THE DESCRIPTION**

*This list of references cited by the applicant is for the reader's convenience only. It does not form part of the European patent document. Even though great care has been taken in compiling the references, errors or omissions cannot be excluded and the EPO disclaims all liability in this regard.*

**Patent documents cited in the description**

- US 20110187886 A1 [0006]
- US 2011080494 A1 [0007]
- US 2013128072 A1 [0008]