

(19) World Intellectual Property Organization  
International Bureau



(43) International Publication Date  
9 June 2005 (09.06.2005)

PCT

(10) International Publication Number  
WO 2005/051822 A1

(51) International Patent Classification<sup>7</sup>: B65H 37/00,  
B65D 83/08, B65H 1/04, 3/02

Jean-Pierre [FR/FR]; 7 rue de la Nativité, F-75012 Paris (FR).

(21) International Application Number:  
PCT/US2004/039582

(74) Agent: SCHINDLER, Barry, J.; Greenberg Traurig LLP, Met Life Building, 200 Park Avenue, New York, NY 10166 (US).

(22) International Filing Date:  
24 November 2004 (24.11.2004)

(81) Designated States (unless otherwise indicated, for every kind of national protection available): AE, AG, AL, AM, AT, AU, AZ, BA, BB, BG, BR, BW, BY, BZ, CA, CH, CN, CO, CR, CU, CZ, DE, DK, DM, DZ, EC, EE, EG, ES, FI, GB, GD, GE, GH, GM, HR, HU, ID, IL, IN, IS, JP, KE, KG, KP, KR, KZ, LC, LK, LR, LS, LT, LU, LV, MA, MD, MG, MK, MN, MW, MX, MZ, NA, NI, NO, NZ, OM, PG, PH, PL, PT, RO, RU, SC, SD, SE, SG, SK, SL, SY, TJ, TM, TN, TR, TT, TZ, UA, UG, US, UZ, VC, VN, YU, ZA, ZM, ZW.

(25) Filing Language: English

(26) Publication Language: English

(30) Priority Data:  
60/524,495 24 November 2003 (24.11.2003) US  
60/533,362 29 December 2003 (29.12.2003) US

(71) Applicant (for all designated States except US): CSP TECHNOLOGIES, INC. [US/US]; 1030 Riverfront Center, P.O. Box 710, Amsterdam, NY 12010 (US).

(72) Inventor; and  
(75) Inventor/Applicant (for US only): GIRAUD,

(84) Designated States (unless otherwise indicated, for every kind of regional protection available): ARIPO (BW, GH, GM, KE, LS, MW, MZ, NA, SD, SL, SZ, TZ, UG, ZM,

[Continued on next page]

(54) Title: MOISTURE-TIGHT EDIBLE FILM DISPENSER AND METHOD THEREOF

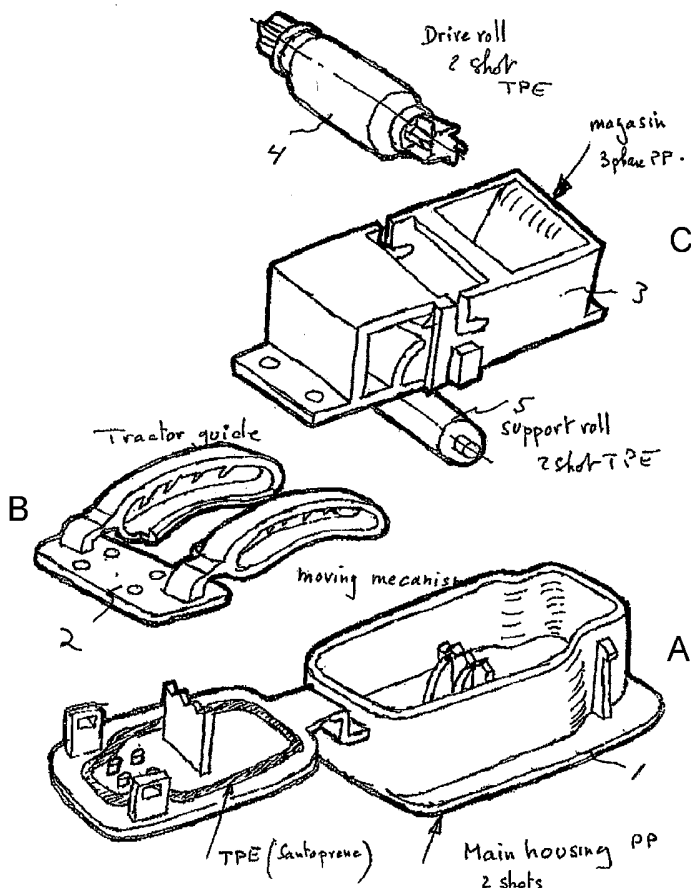

(57) Abstract: A film dispenser for dispensing individual strips of film comprising a main housing with an integrally attached hinged lid, wherein the housing and lid are one injection molded part that interfaces with a body and, when the closed, the lid creates a moisture tight seal with the main housing, the lid having a flexible arm attached to an underside of the lid, an opening in a topline of the main housing where a portion of the opening acts as a hinge point for the flexible arm, and, when the lid is opened, the arm assists in pushing or pulling the film out of the package; the body that is attached to the main housing to form a moisture tight seal with the main housing; and an indexing finger composed of an elastomer and attached to the underside of the hinged lid, the finger interacts with the flexible arm to dispense the individual strips.

WO 2005/051822 A1



ZW), Eurasian (AM, AZ, BY, KG, KZ, MD, RU, TJ, TM), European (AT, BE, BG, CH, CY, CZ, DE, DK, EE, ES, FI, FR, GB, GR, HU, IE, IS, IT, LU, MC, NL, PL, PT, RO, SE, SI, SK, TR), OAPI (BF, BJ, CF, CG, CI, CM, GA, GN, GQ, GW, ML, MR, NE, SN, TD, TG).

— *before the expiration of the time limit for amending the claims and to be republished in the event of receipt of amendments*

**Published:**

— *with international search report*

*For two-letter codes and other abbreviations, refer to the "Guidance Notes on Codes and Abbreviations" appearing at the beginning of each regular issue of the PCT Gazette.*

## **MOISTURE-TIGHT EDIBLE FILM DISPENSER AND METHOD THEREOF**

### **Background Of The Invention**

Certain types of edible films are presently being used as a delivery system for mints  
5 and oral care products. Typically, the film is precut into rectangular pieces and packaged in a  
flat pack-shaped primary package. The edible film is stacked in the package. One problem  
that may be encountered with the present package is the difficulty of removing one piece of  
film from the stack. Another problem that may be encountered with the present package is  
the film pieces, at times, tend to curl during use life (when the film is exposed to moisture).

10 In another application, there is a belief that edible films can be used as a delivery  
system for ethical drugs. The edible film would comprise a carrier made of an edible film and  
a regulated amount of the desired drug. In one such application, the user would insert the  
edible film in their mouth and the edible film would dissolve – immediately dispensing the  
drug into the body. However, in this application, one desires to assure that a unit dose (a  
15 single piece of film) is delivered during use.

### **Summary Of The Invention**

The present invention relates to an edible film dispenser that presents a single strip of  
film during each index cycle. In a further embodiment, the edible film dispenser provides a  
20 moisture tight environment during shelf life and during use life.

The film dispenser of the present invention is illustrated by showing two edible film  
dispenser designs: (1) a continuous film dispenser where a unit dose of film is cut during the  
index cycle and (2) a design that dispenses precut film pieces. However, it is understood that  
these designs are merely illustrative and are not meant to limit the scope of the present  
25 invention.

### **Brief Description Of The Drawings**

Among those benefits and improvements that have been disclosed, other objects and  
advantages of this invention will become apparent from the following description taken in  
30 conjunction with the accompanying figures. The figures constitute a part of this specification  
and include illustrative embodiments of the present invention and illustrate various objects and  
features thereof.

Figures 1A, 1B and 1C are perspective views of one embodiment of the present  
invention showing a continuous film dispenser where Fig. 1A illustrates a flip-top main

housing, Fig. 1B illustrates a tractor guide and Fig. 1C illustrates a drive assembly with drive roller and support roller.

Figure 2 is a side perspective view of one embodiment of the present invention showing a method of feeding the continuous film.

5 Figure 3 is a side perspective view of one embodiment of the present invention showing an operation of the drive mechanism.

Figure 4 is a side perspective view of one embodiment of the present invention showing an indexing of the film from the dispenser.

10 Figures 5A and 5B are perspective views of one embodiment of the present invention showing a continuous film dispenser where Fig. 5A illustrates a side perspective of the dispenser and Fig. 5B illustrates the rotation of the continuous film dispenser.

Figures 6 and 6A are perspective views of different embodiments of the present invention showing a continuous film dispenser with different methods by which a sprocket may be powered to index the bandoleer forward and thus dispense the strips.

15 Figures 7A and 7B are perspective views of one embodiment of the present invention showing a continuous film dispenser where Fig. 7B illustrates a side perspective of the dispenser and Fig. 7A illustrates the rotation of the continuous film dispenser.

Figure 8 is a perspective view of one embodiment of the present invention showing a pre-cut film dispenser.

20 Figures 9A, 9B and 9C are side perspective views of one embodiment of the present invention showing a pre-cut film dispenser where Figs. 9A and 9B illustrate, as the lid is raised, a flexible arm is pulled forward as it is prevented from moving upwards by the hinging point and Fig. 9C, illustrates, when the film dispenser is closed, the flexible arm is pushed through the "T" shaped opening and past the hinging point.

25

### **Detailed Description Of The Present Invention**

Detailed embodiments of the present invention are disclosed herein; however, it is to be understood that the disclosed embodiments are merely illustrative of the invention that may be embodied in various forms. In addition, each of the examples given in connection with the  
30 various embodiments of the invention are intended to be illustrative, and not restrictive. Further, the figures are not necessarily to scale, some features may be exaggerated to show details of particular components. Therefore, specific structural and functional details disclosed herein are

not to be interpreted as limiting, but merely as a representative basis for teaching one skilled in the art to variously employ the present invention.

In one embodiment, the film dispenser of the present invention is illustrated by showing an edible film dispenser designs that dispenses precut film pieces. However, it is understood that this design is merely illustrative and are not meant to limit the scope of the present invention.

In one example, precut pieces of film are packaged in the container (e.g. continuous bandoleer). For example, the bandoleer is composed of 2-pieces of plastic film (e.g. PP, PET, etc) that is die cut and welded together to form pockets that each piece of film is placed. A set of regularly spaced tractor guide holes are placed in the bandoleer. These guide holes are used to precisely index the bandoleer in the dispenser.

In one embodiment, the precut film dispenser is composed of the following components (see Figure 1). The film pieces are stacked directly on top of each other or separated by a release liner. By opening the Lid, an individual strip is indexed off the stack by a small elastomeric pad that pushes it towards a sloped feature that guides the film piece up and out of container so that it can be removed.

In one embodiment, the precut film dispenser is composed of the following components (see e.g., Figure 8):

**1. Lid and Main Housing** – an injection molded part that interfaces with the Body. This component has a Main Housing and a hinged Lid. When closed, the Lid creates a moisture tight seal with the main housing. There is a “T” shaped opening in the Main Housing. In this opening a feature acts as a hinge point for the Flexible Arm as the Arm slides underneath the hinge point. The Lid and Main Housing are bonded to the Body in a manner that creates a moisture tight seal.

**2. Body** – An injection molded part that, for example, is made by two shot molding a material such as polypropylene and, at least a portion of, desiccant plastic. The desiccant plastic absorbs moisture that enters the package during the Shelf Life and Use Life. In one example, the desiccant plastic holds the film pieces and is shaped in the form of a ramp or slope so that the film strip is forced up and out of the package when being indexed. In a further embodiment, a Child Resistant (CR) feature is incorporated into this component as well. By pressing in on CR feature, the Lid can be opened which will cause the film to be dispensed.

3. **Indexing Finger** – An injection molded part that is made, for example, by two shot molding an elastomer and a material such as polypropylene. The Indexing finger is bonded to the hinged Lid during the assembly process. The end of the Indexing Finger that is not bonded to the Lid is made of elastomer and when closed is in contact with the film strip. It fits through the “T” shaped slot in the Main Housing.

In one example of the operation of the present invention, the package is sealed when it is closed. The Lid seals to the Main Housing (e.g. by snapping over a sealing feature). The result is a moisture tight seal. The desiccant plastic absorbs moisture that may come into the package, from the opening and closing of the Dispenser, or that penetrates through the materials. In one example, the absorbing material is used because the Film Strips themselves contain moisture, which may be driven off by changes in temperature that the package goes through. Thus the present invention maintains the Film Strips in a dry environment throughout the Shelf Life and the Use Life.

When the Lid is opened, an Arm, which is attached to the Lid, pushes or pulls the film strip off the stack and out of the package. When the Lid is closed, the Arm returns to a home position, ready for the next dispense cycle.

The following is an illustration of the present invention (as shown in Figures 9A through 9C). In Figure 9C, when the film dispenser is closed, the Flexible Arm is pushed through the “T” shaped opening and past the hinging point. In Figure 9A, as the Lid is raised, the Flexible Arm is pulled forward as it is prevented from moving upwards by the hinging point. The Flexible Arm rides in a channel created by the “T” slot. Since the elastomeric portion of the Flexible Arm is in contact with the Film Strip, the top Film Strip on the stack is pulled forward with the Flexible Arm. As it encounters the sloped feature of the base, it is redirected upwards and through the “T” shaped opening so it is accessible.

The Flexible Arm is returned to the home position, ready to index the next strip, by pushing the Lid back down sealing it to the Main Housing. Alternatively, the user could continue to open the package so the Flexible Arm clears the Hinging Point, which allows it to come out of the “T” slot. The package is closed, which pushes the Flexible Arm back through the “T” slot and under the hinging point ready for the next index.

In one embodiment, the continuous film dispenser is composed of the following components (see Figures 1A, 1B and 1C):

1. **Flip-Top Main Housing (1)** – an injection molded part (e.g. made via 2-shot molding of polypropylene and a thermoplastic elastomer (TPE) i.e., Santoprene). In one embodiment, the Santoprene forms a moisture tight reusable seal.
2. **Tractor Guide (2)** – an injection molded part (e.g. made of polypropylene) that has a base with, for example, 2-caterpillar tractor guides attached. The tractor guide is assembled to the lid of the main housing via posts in the main housing lid. In one example, the assembly may be accomplished by ultrasonic welding.
3. **Drive Assembly (Magazine) (3)** – (e.g. can be made of polypropylene or 3-phase desiccant plastic). In one example, the drive and support rollers are assembled into the magazine, via a snap fit. The magazine also holds a supply of edible film in a single, continuous arrangement. In one example, the drive assembly is placed into the main housing and assembled via spot welding using a heat source or ultrasonic welding.
4. **Drive Roller (4)** – (e.g. can be made via 2-shot molding – polypropylene inner shaft and drive sprockets with a TPE (Santoprene) coating the inner shaft). In one embodiment, the TPE serves as the edible film contact surface. For example, the sprockets of the drive roller are assembled into the tractor guide caterpillars.
5. **Support Roller (5)** – (e.g. can be made via 2-shot molding – polypropylene inner shaft with a TPE (Santoprene) coating the inner shaft). For example, the TPE serves as the edible film contact surface.

In one embodiment, the continuous film dispenser holds a supply of film to support 50 – 100 dispense cycles. Figure 2 is an example of one embodiment of the method of feeding the continuous film. In that example, the edible film supply is not rolled; rather the film is folded into the magazine, similar to an impact printer cartridge ribbon. The continuous piece of edible film is fed between the drive and support rollers.

In this example, the edible film is dispensed while the main housing lid is opened by a user. When the lid is opened, the tractor guide, which is attached to the lid, also rotates upward. During this motion, the drive roller sprockets rotate as the tractor guide caterpillars are displaced by the lid motion (see Figure 3). The edible film is positioned between the drive and support rollers. As the drive roller rotates, the edible film is indexed out of the dispenser (see Figure 4).

When the lid is closed, the film is cut, via a knife-like feature on the underside of the flip-top lid in the main housing (see Figure 1). The lid snaps closed and the moisture-tight seal is reestablished. In one embodiment, the moisture tight seal maintains a moisture ingress below about 300 micro-g/day.

5 In a further embodiment, during lid closing, the tractor guide caterpillars return to the home position. The caterpillar teeth ride over the drive roller sprockets. The drive roller only rotates in 1-direction – the sprocket teeth do not engage the caterpillar and cause the sprockets to rotate during lid closing.

10 In yet another embodiment, a 'brake feature' is included to prevent a user from pulling an excessive amount of film out of the dispenser before cutting. In another example, the features of the lid are designed so that it must be opened some minimum amount to ensure that a full dose of film is indexed out of the dispenser.

15 In an example of an embodiment relating to precut film strips, precut pieces of film are packaged in a container (e.g. continuous bandoleer). For example, the bandoleer is composed of 2-pieces of plastic film (e.g. PP, PET, etc) that is die cut and welded together to form pockets that each piece of film is placed. A set of regularly spaced tractor guide holes are placed in the bandoleer. These guide holes are used to precisely index the bandoleer in the dispenser.

20 In one embodiment, the precut film dispenser is composed of the following components (see Figure 5):

1. **Flip-Top Main Housing (6)** – an injection molded part (e.g. made via 2-shot molding of polypropylene and a thermoplastic elastomer (TPE) i.e., Santoprene). In one example, the Santoprene forms a moisture tight reusable seal. There are a set of through holes in the side walls of the main housing. These holes each have TPE gaskets – the drive shaft & thumb wheel are assembled through these holes.

25 3. **Film Indexing Magazine (7)** – (e.g. can be made of polypropylene or 3-phase desiccant plastic). The drive sprocket is assembled into the magazine (e.g. via a snap fit). The magazine has 2-compartments that hold the continuous bandoleer. One compartment is the supply side (bandoleer filled with edible film pieces) and a take-up compartment (empty bandoleer). The drive assembly is placed into the main housing (e.g. assembled via spot welding using a heat source or ultrasonic welding).

4. **Drive Sprocket** – (e.g. made of polypropylene). The drive sprockets are driven by an external thumb wheel. As the drive sprocket is rotated, the bandoleer is indexed forward. The sprocket moves in 1-direction.

5. **Thumb Wheel & Drive Shaft** – (e.g. made of polypropylene). The sprockets are assembled onto the drive shaft. The drive shaft is fitted into the main housing, through the film indexing magazine. A set of thumb wheels are attached to the ends of the drive shaft.

Figures 5, 6, 6a and 7 illustrate different methods ( although not limited to these methods) by which the sprocket may be powered to index the bandoleer forward. In all cases, individual pieces of film are packaged into a bandoleer. The dispenser has supply and take-up compartments. The bandoleer is a disposable component. However, it is understood that these designs are merely illustrative and are not meant to limit the scope of the present invention.

#### **Embodiment in Figure 5**

1. Open Flip-top lid.
- 15 2. Rotate thumb wheel to index a piece of film.
3. Remove film.
4. Close lid.

#### **Embodiment in Figure 6**

1. Open Flip-top lid.
- 20 2. Pusher indexing slider forward to index a piece of film.
3. Remove film.
4. Close lid.

#### **Embodiment in Figure 6a (double action flip-top lid)**

1. Open half portion of the Flip-top lid.
- 25 2. Pusher indexing slider forward to index a piece of film.
3. Remove film.
4. Close half portion of the lid.

#### **Embodiment in Figure 7**

1. Open half portion of the Flip-top lid.

2. Squeeze the dispenser together to index a piece of film (dispenser uses a rack and pinion design to index the bandoleer).
3. Remove film.
4. Close half portion of the lid.

5           In yet another embodiment, the present invention may also include a dispenser that is either disposable or reusable. For example, the entire dispenser is discarded after one emptying out the edible film. In the reusable case, in one example, the spent bandoleer is disposable so that a new bandoleer filled with film piece may be reloaded into the re-usable dispenser. In another embodiment, part of the dispenser may be made of a desiccant plastic  
10 such as, but not limited to, disclosed in U. S. Patent 5,911,937 and 6,214,255, which are incorporated by reference herein. For example, the film indexing magazine may be made of a desiccant plastic. In another example, the dispenser may hold a desired quantity of edible film – such as 25, 50, 75, and/or 100 units.

          In one embodiment, the dispenser of the present invention is designed to maintain a  
15 moisture tight seal during shelf and use life of less than about 300 micro-g/day. For purposes of the present invention, in another embodiment, the dispenser of the present invention is “moisture tight” in accordance with the test protocols set forth in USP 671. In one embodiment, the dispenser is considered “moisture tight” where not more than one of the 10 test dispenser exceeds 100 mg per day, per liter, in moisture permeability. Testing for USP  
20 671 is conducted on sealed containers and on containers that have been opened and then resealed. The testing consists of a desiccant of set quantity 4-8 mesh, anhydrous calcium chloride being first dried at 110 degrees for one hour then cooled in a desiccator. Then 12 containers of uniform size are selected and opened and closed 30 times each. Torque is applied to the closures as specified in the USP monograph. Desiccant is then added to 10 of  
25 the packages labeled test containers. These are then filled to within 13mm of the opening on containers larger than 20ml and to two-thirds full on containers smaller than 20ml. The closures are then applied to the torque specified in the monograph. Weight is recorded to the nearest 0.1mg for containers smaller than 20ml, to the nearest mg for 20ml to 200ml, or to the nearest centigram if the container is larger than 200ml. The containers are stored at 75  
30 percent, plus or minus three percent, relative humidity at a temperature of 23 degrees, plus or minus two degrees. After 36 hours, plus or minus one hour, the weight is recorded, with the moisture permeability calculated in mg per day, per liter.

The following is an illustrative example that tests breath strips in the container of the present invention compared with a non-desiccated breath strip pack at 25C 80% RH to determine the effectiveness of these packs in protecting the strips during use life. Watson  
5 Spearmint Breath strips, Wrigley's Spearmint Breath strips and strips from Pfizer were tested at 25C 80% Rh to determine the variation in strip chemistry stability for this use life condition in their own primary packaging.

**Test 1 (Current Container)**

- 10
1. Tested five replicates of breath strips for each variable or pull.
  2. 24 - Watson Strips each (in current container) were placed into a chamber at 25C/80% Rh and physical descriptions were taken for each strip set prior to the test.
  3. Looked at samples every 24 hours to look for changes in appearance. Pulled samples from chamber when samples began to block or stick together.

15

**Test 2 (Present Invention)**

1. Tested five replicates of breath strips for each variable or pull.
2. 24 - Watson Strips each (in Desiccated CSP pocket pack) placed into a chamber at 25C/80% Rh and physical descriptions were taken for each strip set prior to the test.
- 20 3. Looked at samples every 24 hours to look for changes in appearance. Pulled samples from chamber when samples began to block or stick together.

**Results:**

**Test 1**

- 25
1. All Watson strips were blocking in all containers within 24 hours. There was no color change seen in any of the strips.

**Test 2**

- 30
1. No blocking after 21-days. Approx, 1/3 desiccant capacity used, but rate of desiccant absorption rate is slower than ingress into the package after 21-days. All Watson strips were blocking in all containers after 22 days. There was no color change seen in any of the strips.

Whereas particular embodiments of the present invention have been described above as examples, it will be appreciated that variations of the details may be made without  
35 departing from the scope of the invention. One skilled in the art will appreciate that the present invention can be practiced by other than the disclosed embodiments, all of which are presented in this description for purposes of illustration and not of limitation. It is noted that equivalents of the particular embodiments discussed in this description may practice the

invention as well. Therefore, reference should be made to the appended claims rather than the foregoing discussion of examples when assessing the scope of the invention in which exclusive rights are claimed.

What is claimed is:

1. A film dispenser for dispensing individual strips of film comprising:

5 (a) a main housing with an integrally attached hinged lid, wherein the housing and lid are one injection molded part that interfaces with a body and, when the lid is closed, the lid creates a moisture tight seal with the main housing, the lid having a flexible arm attached to an underside of the lid, an opening in a topside of the main housing where a portion of the opening acts as a hinge point for the flexible arm, and, when the lid is opened, the arm assists in dispensing the film out of the package;

10 (b) the body that is attached to the main housing to form a moisture tight seal with the main housing; and

(c) an indexing finger composed of an elastomer and attached to the underside of the hinged lid, the finger interacts with the flexible arm to dispense the individual strips.

2. The film dispenser of claim 1 wherein the body is an injection molded part that is made by two shot molding.

15 3. The film dispenser of claim 2 wherein at least a portion of the housing is composed of a desiccant plastic.

4. The film dispenser of claim 3 wherein the desiccant plastic is shaped in the form of a ramp or slope so that the film strip is forced up and out of the package when being indexed.

20 5. The film dispenser of claim 1 wherein a child resistant feature is incorporated into the dispenser.

6. A method of indexing individual strips of film comprising the steps of:

closing a lid of a film dispenser that results in pushing a flexible arm, which is located on an underside of the lid, through a "T" shaped opening in a housing and past a hinging point in the opening;

25 raising the lid that results in the flexible arm being pulled forward as the arm is prevented from moving upwards by the hinging point and, as such, the flexible arm rides in a channel of the "T" shaped opening; and

contacting the film strip with the arm so that an individual film strip, which is on top of a stack of film strips in the housing, is dispensed with the flexible arm.

30 7. A film dispenser for dispensing individual strips of film comprising:

an injection molded flip-top main housing comprising a main housing with an integrally attached hinged lid

a tractor guide that has a base with caterpillar tractor guides attached, the tractor guide is attached to an interior portion of the lid of the main housing;

a magazine with a drive assembly, the magazine holds a supply of continuous film strips;

5 a drive roller integral with the magazine whereby sprockets of the drive roller are assembled into the tractor guide caterpillars and assists in dispensing the strips; and

a support roller integral with the magazine.

8. A method of indexing individual strips of film comprising the steps of:

10 opening a lid of a film dispenser that causes a tractor guide, which is attached to an interior portion of the lid, to rotate upward;

rotating drive roller sprockets as a result of the tractor guide being displaced by the lid motion;

indexing the strip out of the dispenser as the driver roller rotates, whereby the continuous edible film is positioned between the drive and support rollers;

15 closing the lid that results in the individual film being cut by a knife-like feature on the underside of the lid and resulting in a forming a moisture-tight seal between the lid and a housing of the dispenser.

20 9. The method of indexing individual strips of claim 8 whereby, during lid closing, the tractor guide returns to a home position whereby the tractor guide ride over the drive roller sprockets and the drive roller rotates in one -direction so that the sprocket does not engage the tractor guide and cause the sprocket to rotate during lid closing.

10. The dispenser of claim 7 whereby the supply of continuous film strips is a continuous bandoleer.

25 11. The dispenser of claim 10 whereby the bandolier is composed of 2-pieces of plastic film that are die cut and welded together to form pockets that each piece of film is placed.

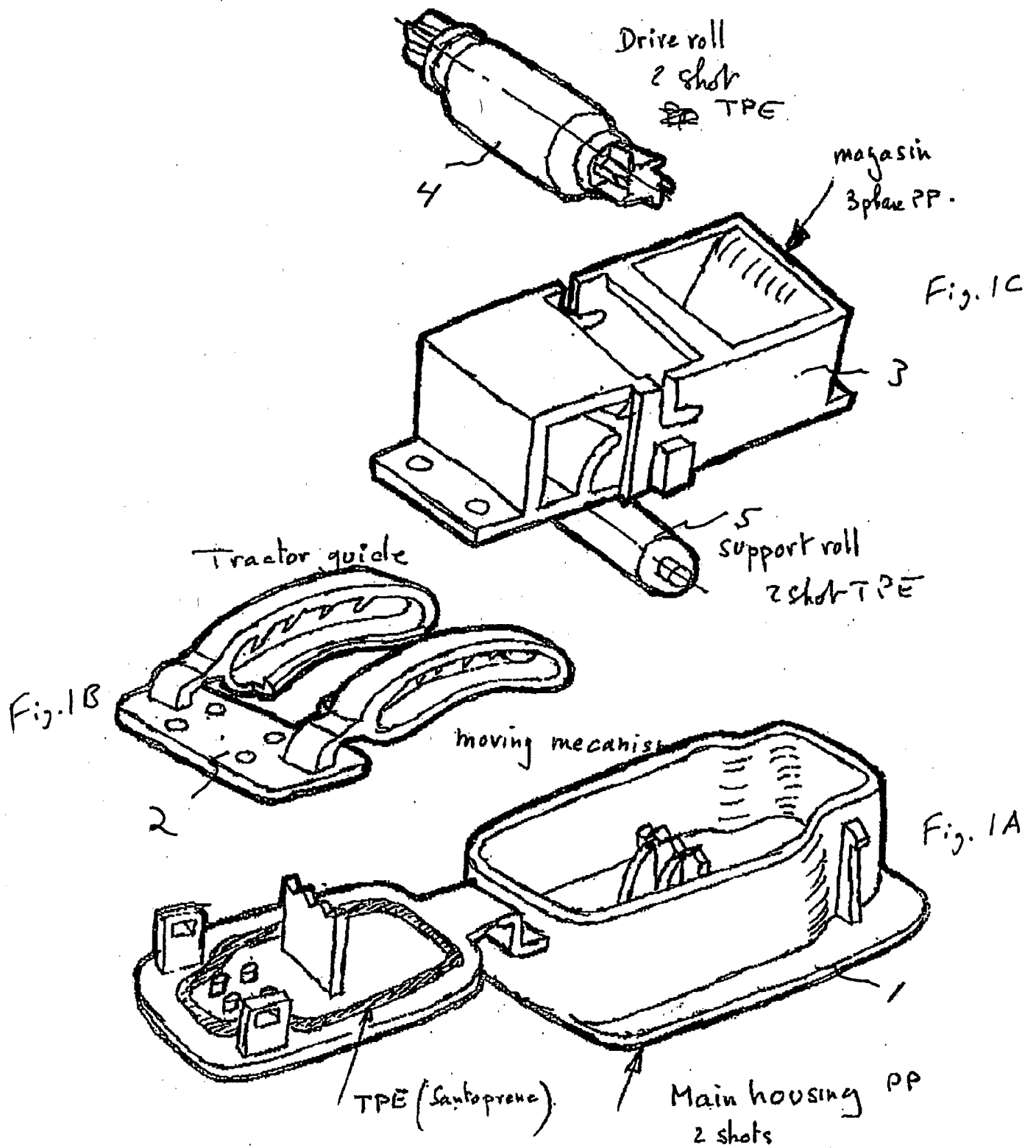

FIG 1.

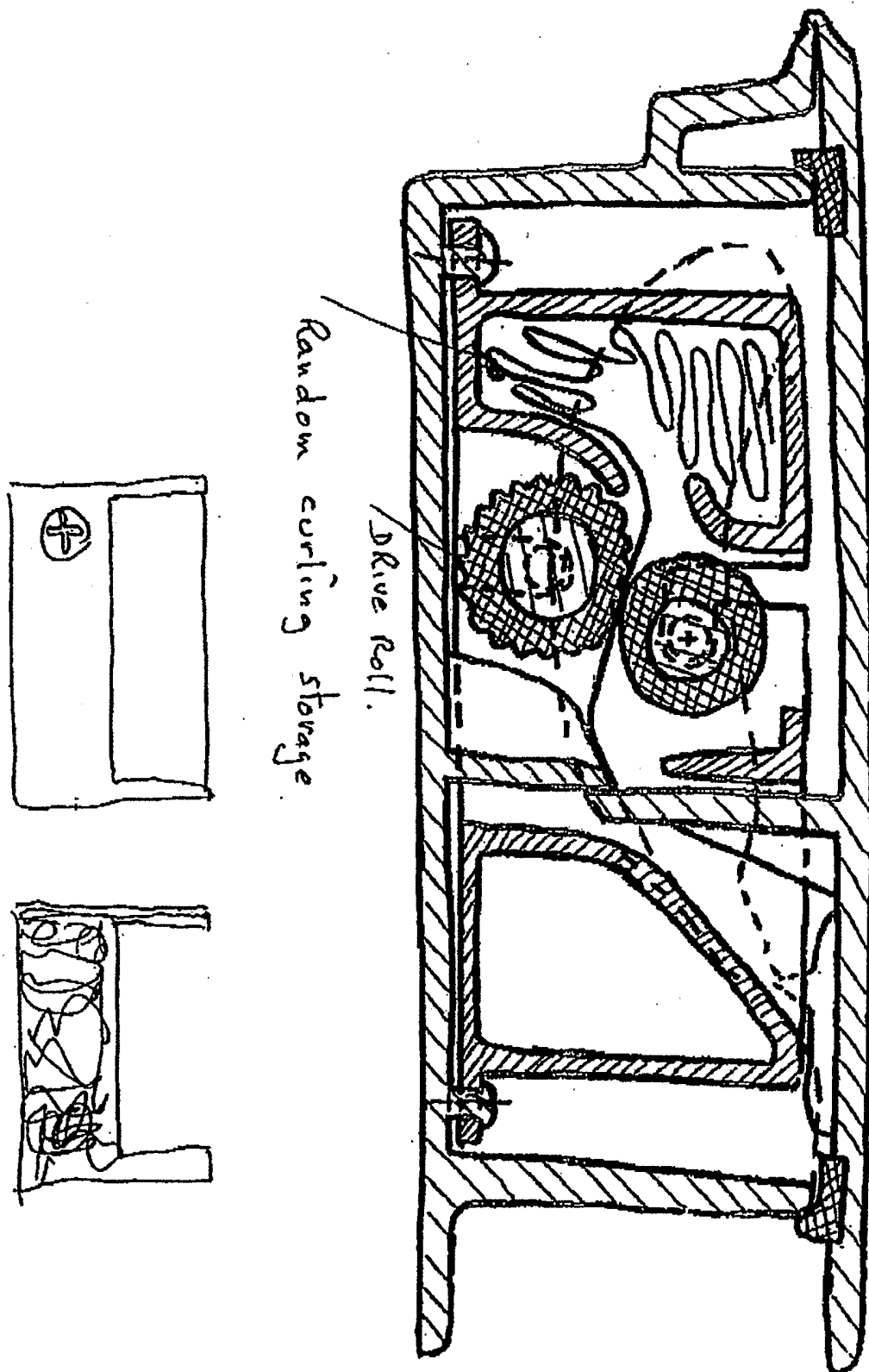

FIG. 2

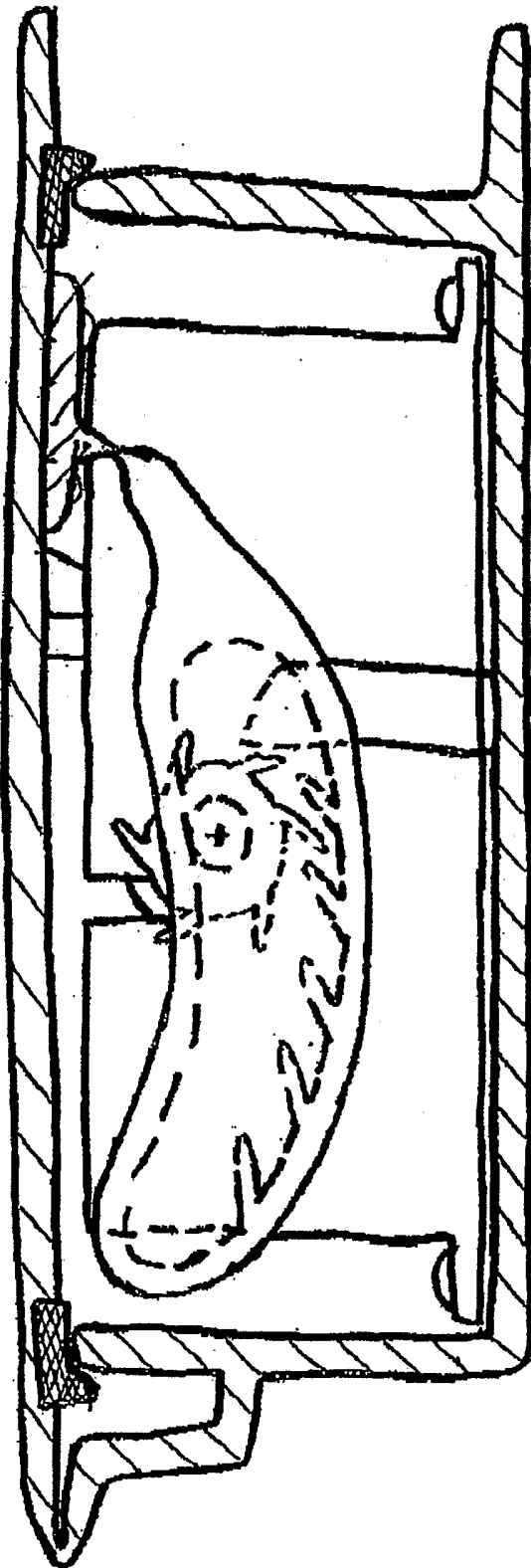

FIG. 3

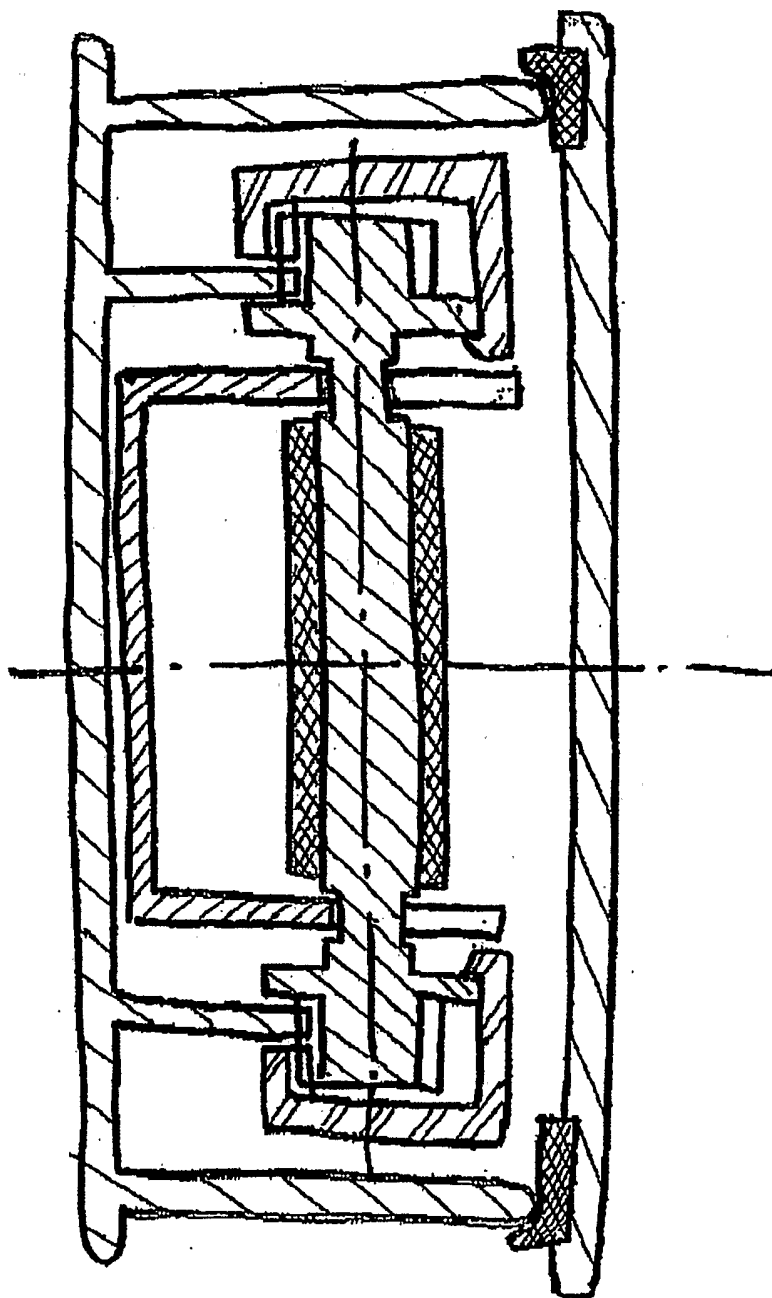

FIG. 4

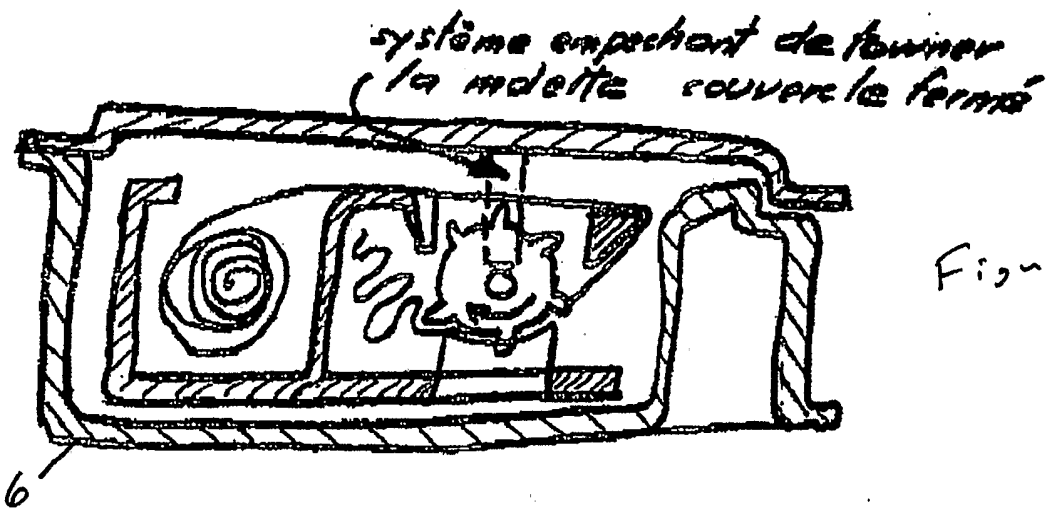

Figure 5A

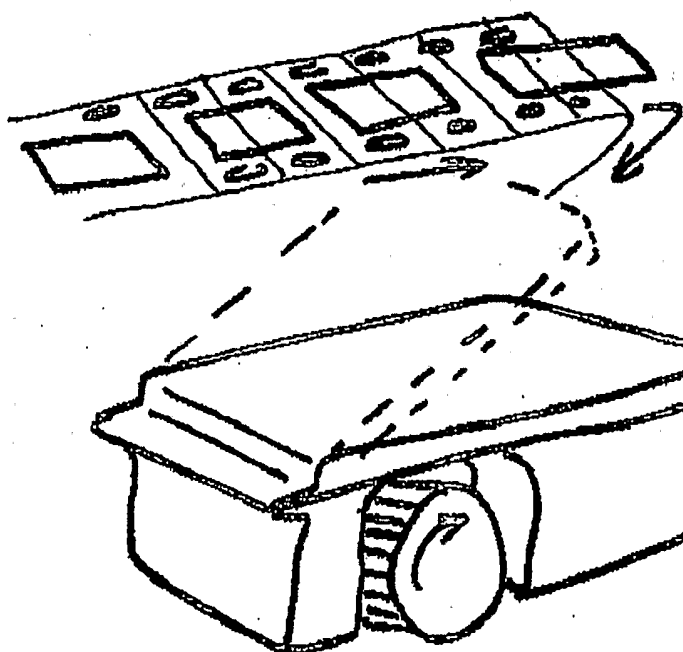

Figure 5B

- a) ouverture du couvercle
- b) rotation jusqu'à blocage
- c) prise du strip
- d) fermeture couvercle

⚠ Reste à trouver: Limiter la rotation (1 ou 1/2 tour) jusqu'à la fermeture suivante du couvercle

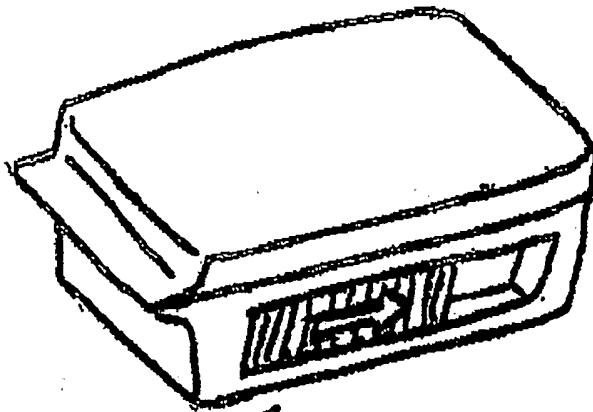

Fig. 6

↑  
 curseur faisant tourner la  
 molette et faisant ouvrir le  
 couvercle à mi-course environ



: gros problème: comment  
 tenir le distributeur pour  
 ne pas empêcher l'ouverture  
 du couvercle ???

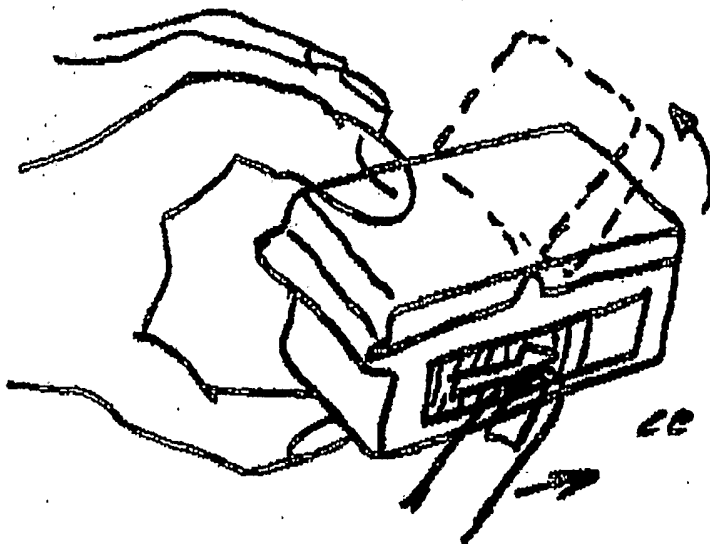

Fig. 6a

même dans  
 cette version  
 plus compliquée  
 ce n'est pas évident!!!

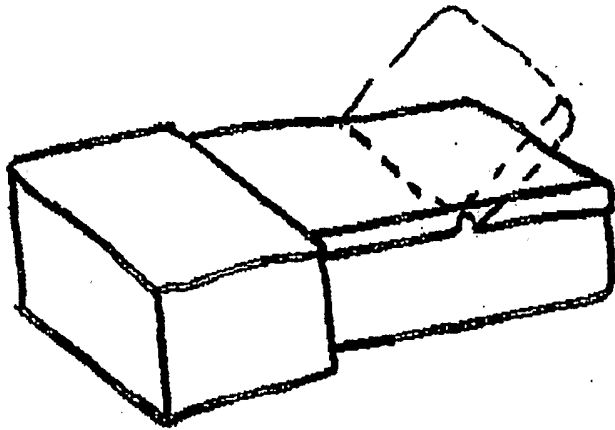

Fig. 7A

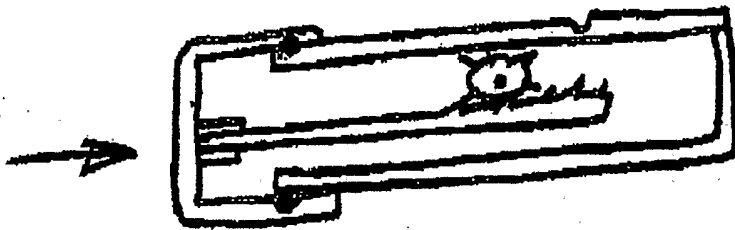
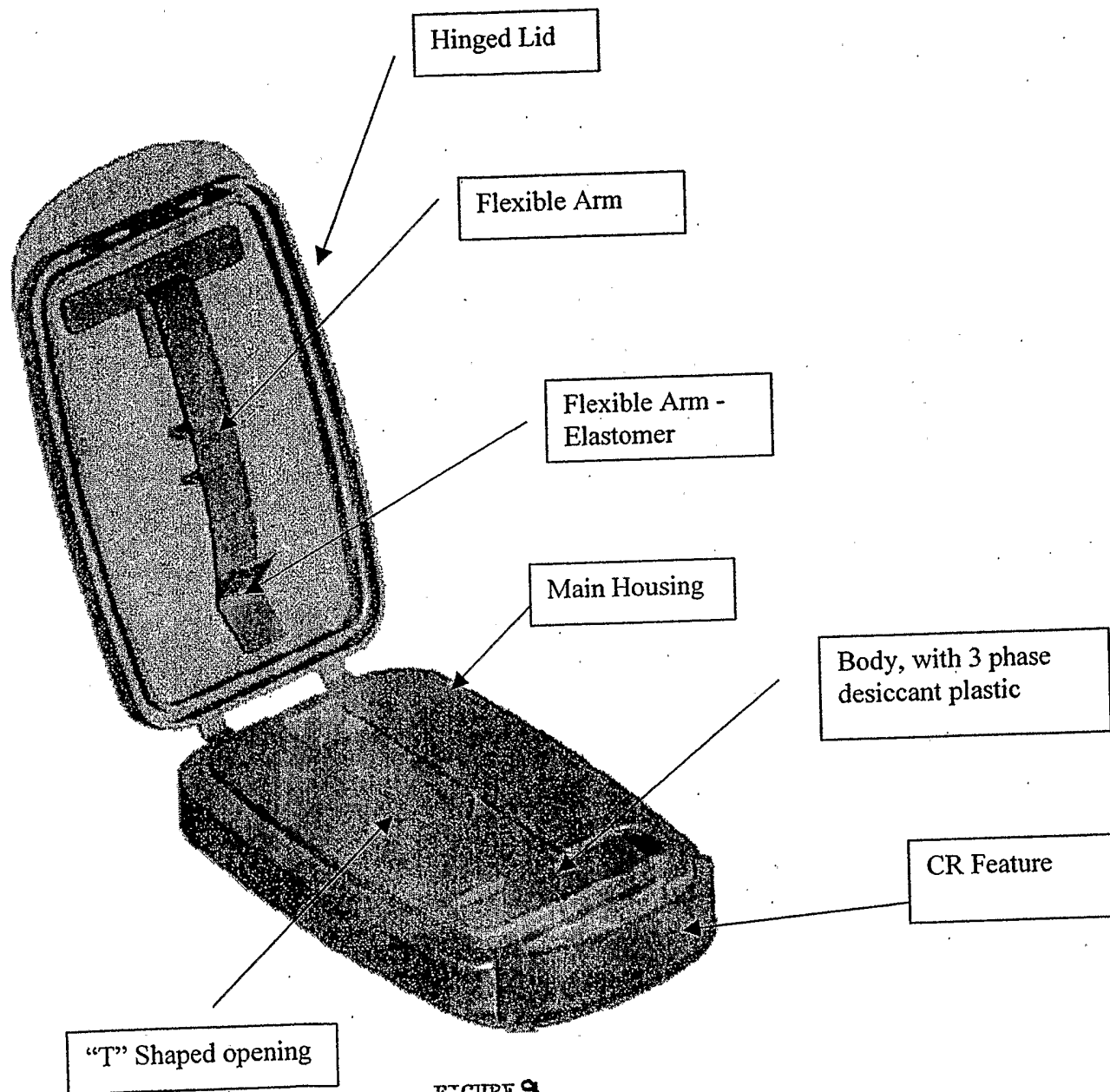

Fig. 7B

Une version à crémaillère devient  
très compliquée  
(nombre de pièces, problèmes  
d'étanchéité, refermeture  
du couvercle, etc)

FIG. 7



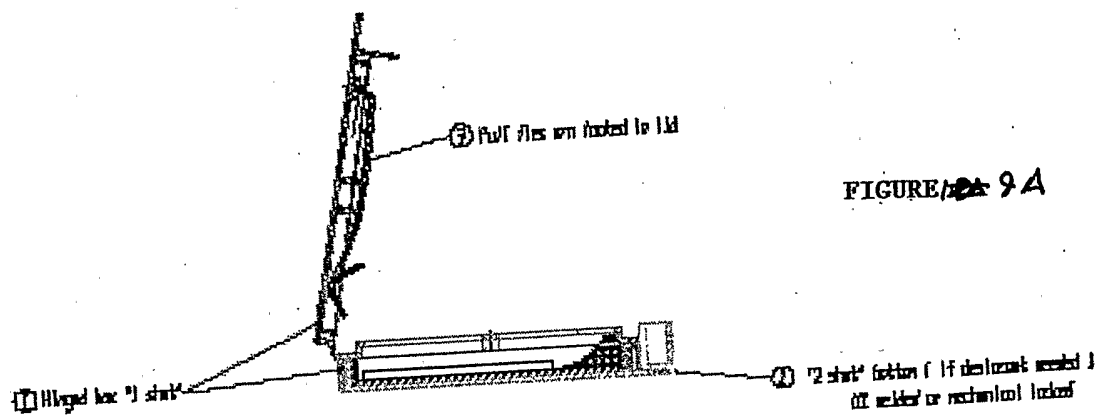

FIGURE ~~9A~~ 9A

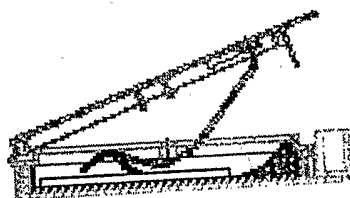

FIGURE ~~9B~~ 9B

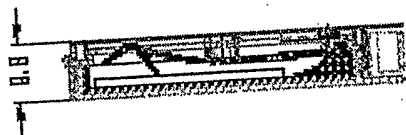

FIGURE ~~9C~~ 9C

# INTERNATIONAL SEARCH REPORT

International Application No  
PCT/US2004/039582

<b>A. CLASSIFICATION OF SUBJECT MATTER</b> IPC 7 B65H37/00 B65D83/08 B65H1/04 B65H3/02				
According to International Patent Classification (IPC) or to both national classification and IPC				
<b>B. FIELDS SEARCHED</b>				
Minimum documentation searched (classification system followed by classification symbols) IPC 7 B65D B65H				
Documentation searched other than minimum documentation to the extent that such documents are included in the fields searched				
Electronic data base consulted during the international search (name of data base and, where practical, search terms used)  EPO-Internal, PAJ				
<b>C. DOCUMENTS CONSIDERED TO BE RELEVANT</b>				
Category °	Citation of document, with indication, where appropriate, of the relevant passages	Relevant to claim No.		
A	DE 42 05 805 A1 (FRIEDRICH SANNER GMBH & CO KG SPRITZGUSSWERK) 2 September 1993 (1993-09-02) the whole document	1,6		
A	US 6 578 732 B1 (MABRY, HELLEN) 17 June 2003 (2003-06-17) the whole document	1,6		
A	US 4 832 229 A (HACKMANN ET AL) 23 May 1989 (1989-05-23) column 1, line 6 - column 4, line 10; figures	7-11		
A	US 6 268 032 B1 (MERTENS TIMOTHY A ET AL) 31 July 2001 (2001-07-31) column 17, line 6 - line 45; figures 20,21	7,8		
----- -/--				
<input checked="" type="checkbox"/> Further documents are listed in the continuation of box C. <span style="margin-left: 200px;"><input checked="" type="checkbox"/> Patent family members are listed in annex.</span>				
° Special categories of cited documents :				
<table style="width: 100%; border: none;"> <tr> <td style="width: 50%; border: none; vertical-align: top;">                     "A" document defining the general state of the art which is not considered to be of particular relevance                      "E" earlier document but published on or after the international filing date                      "L" document which may throw doubts on priority claim(s) or which is cited to establish the publication date of another citation or other special reason (as specified)                      "O" document referring to an oral disclosure, use, exhibition or other means                      "P" document published prior to the international filing date but later than the priority date claimed                 </td> <td style="width: 50%; border: none; vertical-align: top;">                     "T" later document published after the international filing date or priority date and not in conflict with the application but cited to understand the principle or theory underlying the invention                      "X" document of particular relevance; the claimed invention cannot be considered novel or cannot be considered to involve an inventive step when the document is taken alone                      "Y" document of particular relevance; the claimed invention cannot be considered to involve an inventive step when the document is combined with one or more other such documents, such combination being obvious to a person skilled in the art.                      "&amp;" document member of the same patent family                 </td> </tr> </table>			"A" document defining the general state of the art which is not considered to be of particular relevance "E" earlier document but published on or after the international filing date "L" document which may throw doubts on priority claim(s) or which is cited to establish the publication date of another citation or other special reason (as specified) "O" document referring to an oral disclosure, use, exhibition or other means "P" document published prior to the international filing date but later than the priority date claimed	"T" later document published after the international filing date or priority date and not in conflict with the application but cited to understand the principle or theory underlying the invention "X" document of particular relevance; the claimed invention cannot be considered novel or cannot be considered to involve an inventive step when the document is taken alone "Y" document of particular relevance; the claimed invention cannot be considered to involve an inventive step when the document is combined with one or more other such documents, such combination being obvious to a person skilled in the art. "&" document member of the same patent family
"A" document defining the general state of the art which is not considered to be of particular relevance "E" earlier document but published on or after the international filing date "L" document which may throw doubts on priority claim(s) or which is cited to establish the publication date of another citation or other special reason (as specified) "O" document referring to an oral disclosure, use, exhibition or other means "P" document published prior to the international filing date but later than the priority date claimed	"T" later document published after the international filing date or priority date and not in conflict with the application but cited to understand the principle or theory underlying the invention "X" document of particular relevance; the claimed invention cannot be considered novel or cannot be considered to involve an inventive step when the document is taken alone "Y" document of particular relevance; the claimed invention cannot be considered to involve an inventive step when the document is combined with one or more other such documents, such combination being obvious to a person skilled in the art. "&" document member of the same patent family			
Date of the actual completion of the international search	Date of mailing of the international search report			
6 April 2005	18/04/2005			
Name and mailing address of the ISA	Authorized officer			
European Patent Office, P.B. 5818 Patentlaan 2 NL - 2280 HV Rijswijk Tel. (+31-70) 340-2040, Tx. 31 651 epo nl, Fax: (+31-70) 340-3016	Raven, P			

# INTERNATIONAL SEARCH REPORT

International Application No  
PCT/US2004/039582

C.(Continuation) DOCUMENTS CONSIDERED TO BE RELEVANT		
Category °	Citation of document, with indication, where appropriate, of the relevant passages	Relevant to claim No.
A	US 6 299 018 B1 (KIMBRELL, KIMBERLY L) 9 October 2001 (2001-10-09) the whole document -----	7,8

# INTERNATIONAL SEARCH REPORT

Information on patent family members

International Application No

PCT/US2004/039582

Patent document cited in search report	Publication date	Publication date	Patent family member(s)	Publication date
DE 4205805	A1	02-09-1993	NONE	
US 6578732	B1	17-06-2003	NONE	
US 4832229	A	23-05-1989	DE 3523173 A1 AT 45928 T DE 3665293 D1 EP 0206185 A2	08-01-1987 15-09-1989 05-10-1989 30-12-1986
US 6268032	B1	31-07-2001	AU 6145798 A CA 2303018 A1 EP 1302333 A2 EP 1027191 A1 WO 9917906 A1	27-04-1999 15-04-1999 16-04-2003 16-08-2000 15-04-1999
US 6299018	B1	09-10-2001	NONE	