



(12) **United States Design Patent**  
**Bagramyan**

(10) **Patent No.:** **US D875,545 S**  
(45) **Date of Patent:** **\*\* Feb. 18, 2020**

- (54) **CASE**
  - (71) Applicant: **Genrik Bagramyan**, Burbank, CA (US)
  - (72) Inventor: **Genrik Bagramyan**, Burbank, CA (US)
  - (\*\*) Term: **15 Years**
  - (21) Appl. No.: **29/668,221**
  - (22) Filed: **Oct. 29, 2018**
  - (51) **LOC (12) Cl.** ..... **09-01**
  - (52) **U.S. Cl.**  
USPC ..... **D9/669**; D21/658; D28/8.2
  - (58) **Field of Classification Search**  
USPC ..... D3/205, 282, 294, 211, 234, 238;  
D6/597, 539, 634; D9/669; D21/658;  
D28/8.1, 8.2
- See application file for complete search history.

2019. Available from Internet URL: [https://www.amazon.co.uk/dp/B07G7195R4/ref=cm\\_sw\\_r\\_tw\\_dp\\_U\\_x\\_RBwIDbQEAA00BE](https://www.amazon.co.uk/dp/B07G7195R4/ref=cm_sw_r_tw_dp_U_x_RBwIDbQEAA00BE) (Year: 2018).\*

Star Shaped Cookie Cutter Set 5 Pieces Nylon Cake Cutter Biscuit Cutter Set with Plastic Case: Published Dec. 11, 2017[ online], site visited Sep. 23, 2019. Available from Internet URL: <https://www.amazon.com/Shaped-Cookie-Cutter-Biscuit-Plastic/dp/B07D28W2WB> (Year: 2017).\*

\* cited by examiner

*Primary Examiner* — Jack Reickel  
*Assistant Examiner* — Melvin L Davis  
 (74) *Attorney, Agent, or Firm* — Dunlap Bennett & Ludwig PLLC; Brendan E. Squire

(56) **References Cited**

**U.S. PATENT DOCUMENTS**

D152,005 S *	12/1948	Lewis	.....	D9/669
D431,187 S *	9/2000	Davis	.....	D11/131
D438,788 S *	3/2001	Rigel	.....	D9/669
D449,981 S *	11/2001	Davis	.....	D9/669
D462,898 S *	9/2002	Weinstock	.....	D9/669
D478,180 S *	8/2003	Boss	.....	D9/669
D551,979 S *	10/2007	Daniels	.....	D9/456
D561,686 S *	2/2008	Saunders	.....	D13/100
D575,508 S *	8/2008	Shanahan	.....	D3/211
D613,026 S *	4/2010	Fitzpatrick	.....	D1/106
D650,694 S *	12/2011	Eisenberger	.....	D9/669
D678,781 S *	3/2013	Andreotti	.....	D9/669
D680,006 S *	4/2013	Andreotti	.....	D9/669
D685,647 S *	7/2013	Andreotti	.....	D9/669
D697,686 S *	1/2014	Kerr	.....	D1/106
D731,007 S *	6/2015	Davies, III	.....	D21/680
D771,899 S *	11/2016	Wehling	.....	D1/106
D803,069 S *	11/2017	Figuels	.....	D9/709

**OTHER PUBLICATIONS**

PowerKing Fillable Ornament Ball, Clear Transparent Ball & Plastic DIY: Published Aug. 5, 2018 [online], site visited Sep. 23,

(57) **CLAIM**

The ornamental design for a case, as shown and described.

**DESCRIPTION**

FIG. 1 is a top front perspective view of the case showing our new design;

FIG. 2 is a front elevation view thereof;

FIG. 3 is a rear elevation view thereof;

FIG. 4 is a right elevation view thereof;

FIG. 5 is a left elevation view thereof;

FIG. 6 is a top elevation view thereof;

FIG. 7 is a bottom elevation view thereof;

FIG. 8 is a top front perspective view thereof in an open arrangement where the arrows represent motion of the points; and,

FIG. 9 is a top front perspective view in an open arrangement in an alternate state of use, where the evenly broken lines represent alignment and form no part of the claimed design.

The broken lines shown in the drawings illustrate portions of the case that form no part of the claimed design.

**1 Claim, 4 Drawing Sheets**

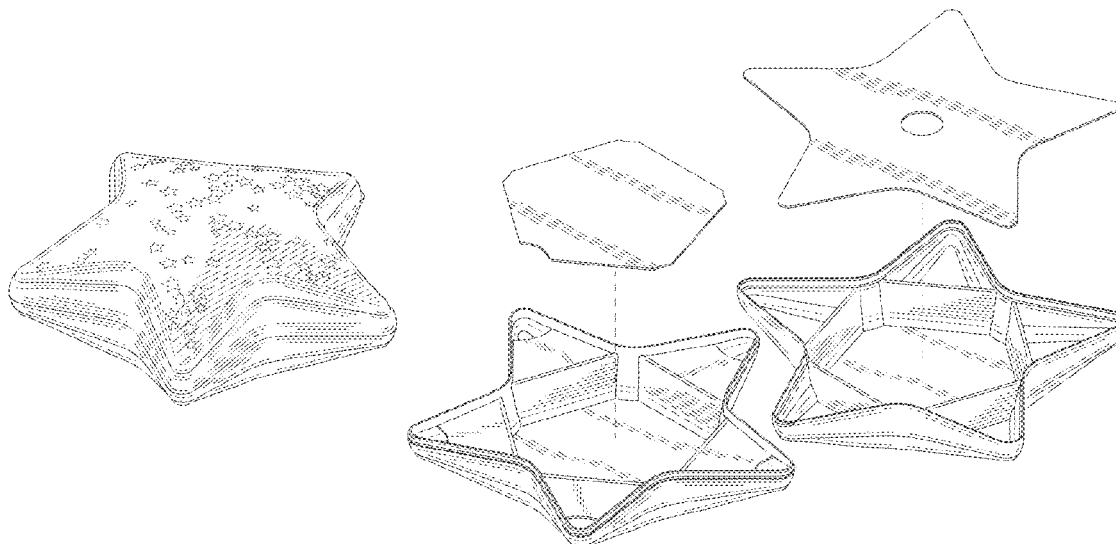

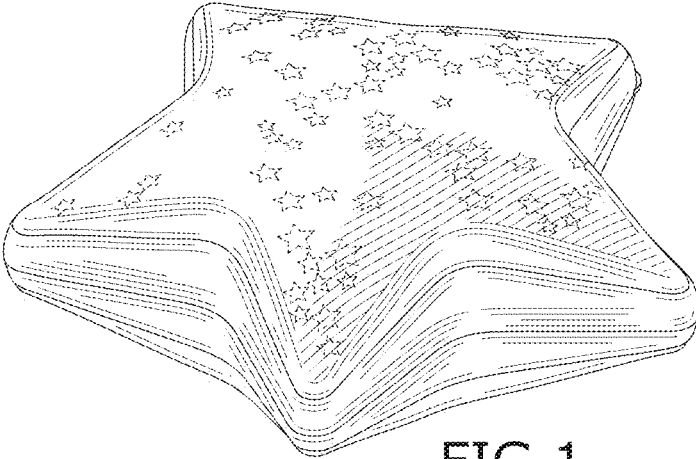

FIG. 1

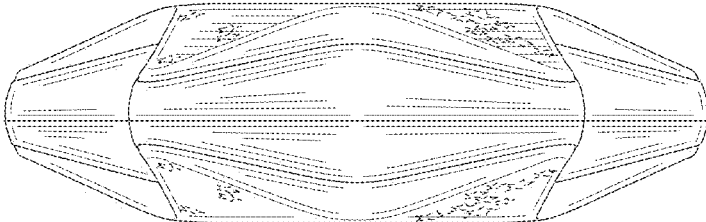

FIG. 2

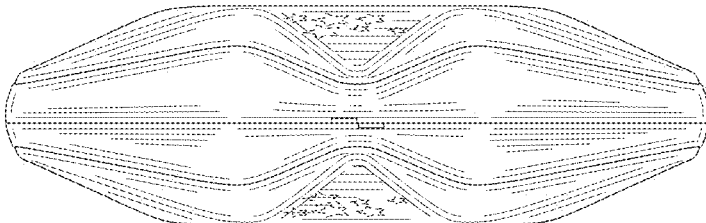

FIG. 3

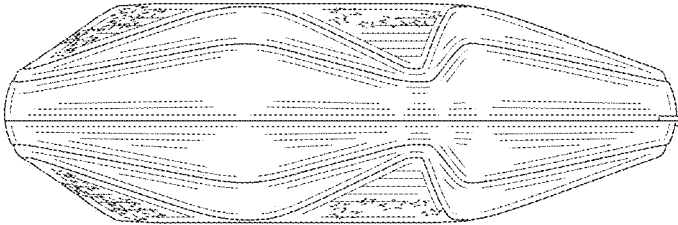

FIG. 4

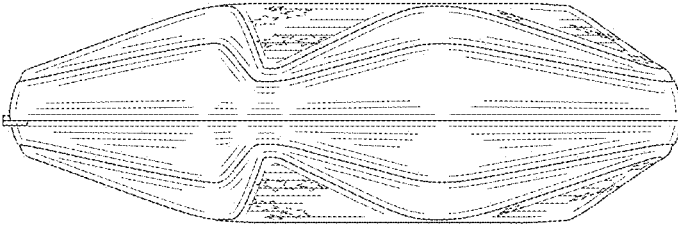

FIG. 5

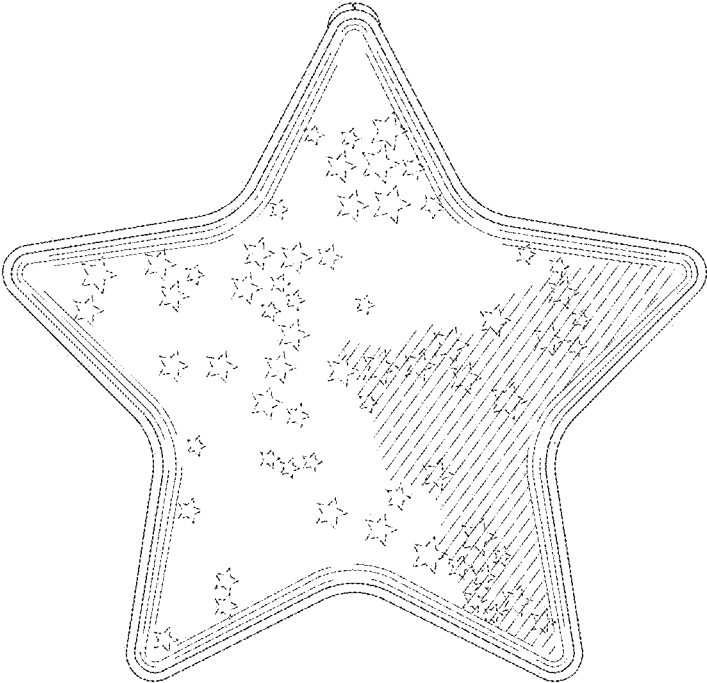

FIG. 6

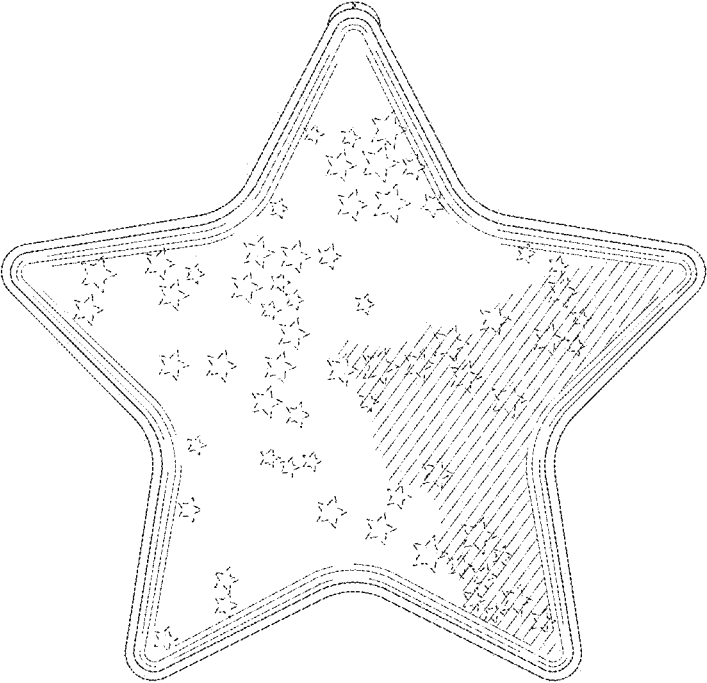

FIG. 7

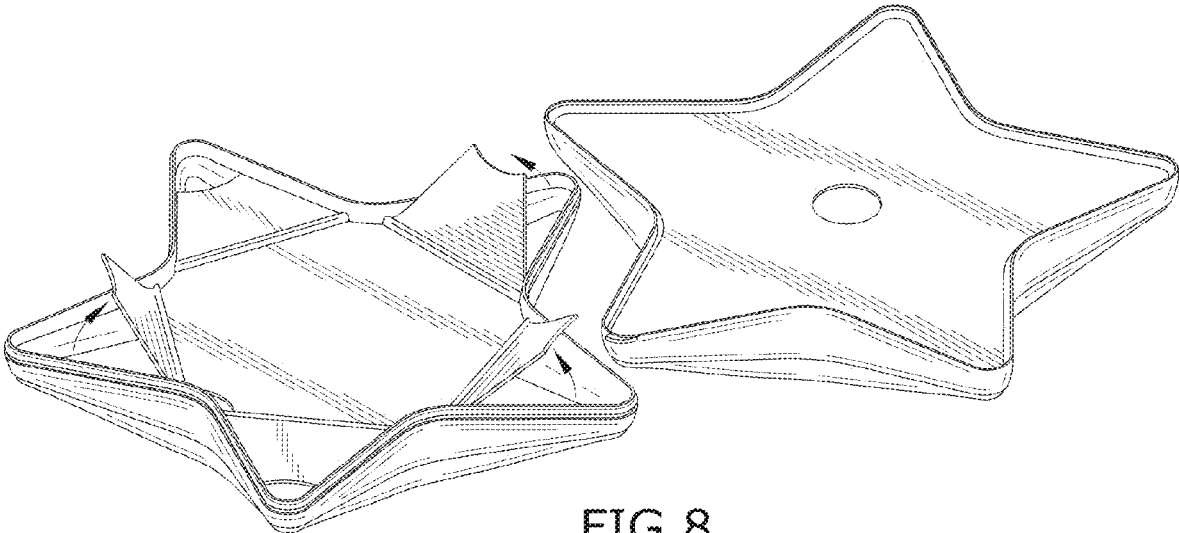

FIG. 8

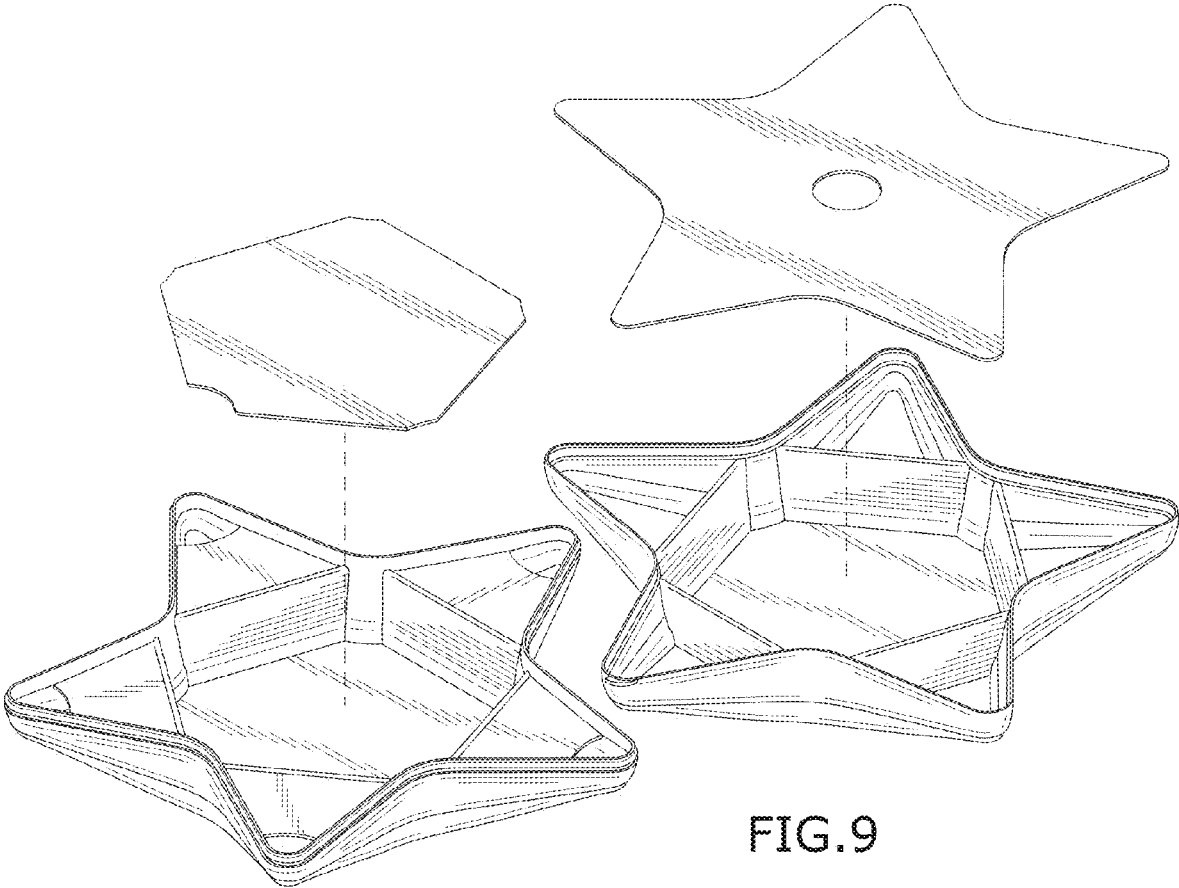

FIG. 9