

C.C. Dickerman's Improvements in Locks:

108770

PATENTED Nov 1 1870

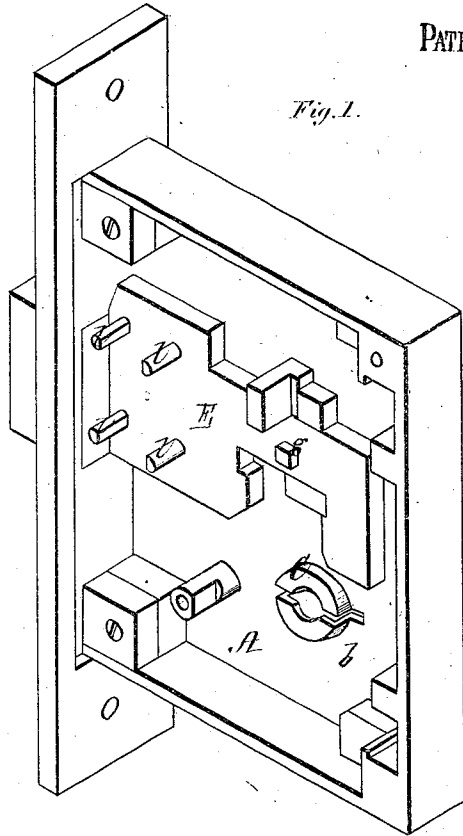

Fig. 1.

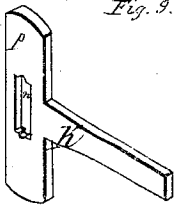

Fig. 9.

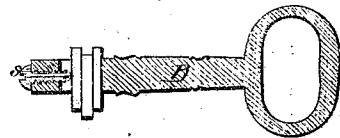

Fig. 7.

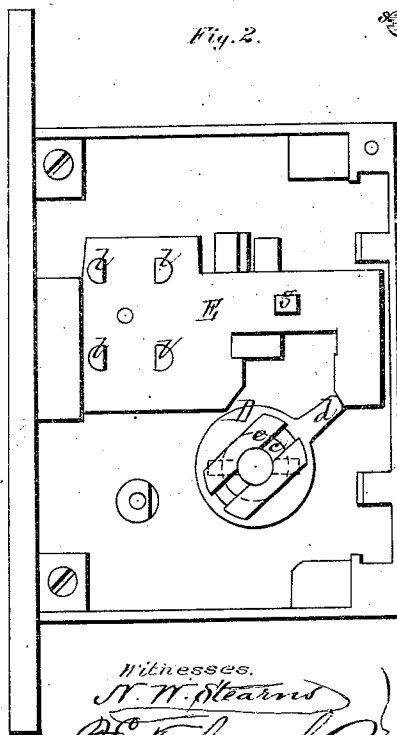
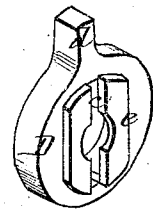

Fig. 2.

Fig. 8.



Witnesses.  
N. W. Stearns  
P. S. Schenck

Inventor.  
Chas. C. Dickerman

C. C. Dickerman's Improvements in Locks:

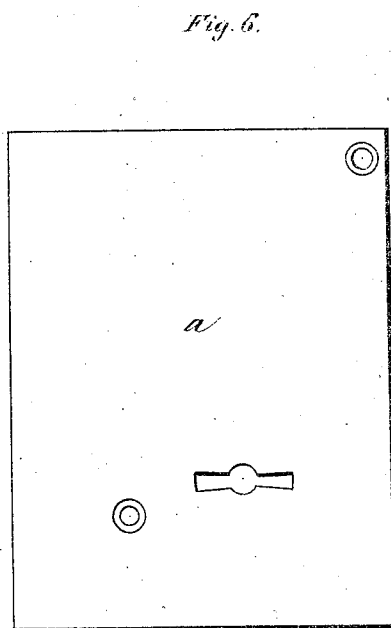
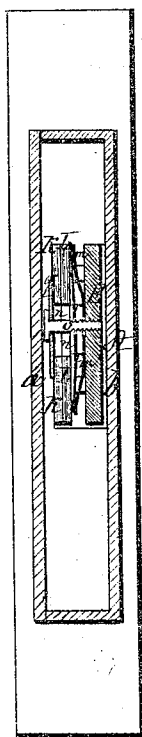
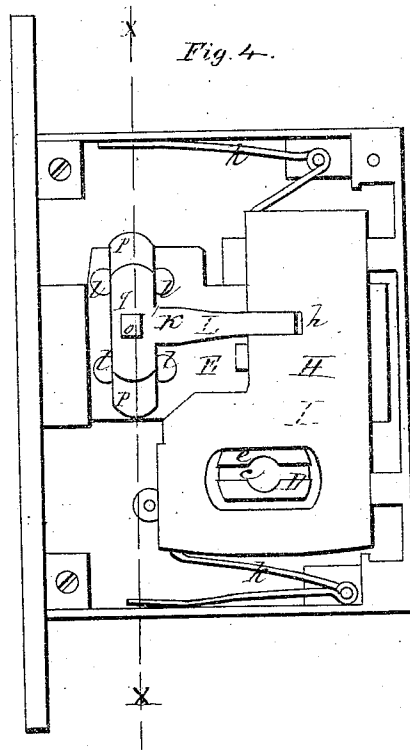
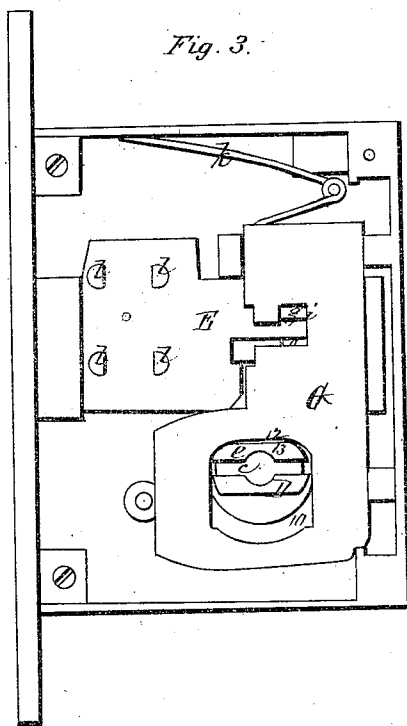

Witnesses.  
*N. W. Stearns*  
*C. C. Dickerman*

Inventor.  
*Chas. C. Dickerman*

# United States Patent Office.

CHARLES C. DICKERMAN, OF BOSTON, MASSACHUSETTS.

Letters Patent No. 108,770, dated November 1, 1870; antedated October 28, 1870.

## IMPROVEMENT IN LOCKS

The Schedule referred to in these Letters Patent and making part of the same.

To all whom it may concern:

Be it known that I, CHARLES C. DICKERMAN, of Boston, in the county of Suffolk and State of Massachusetts, have invented certain Improvements in Locks, of which the following is a full, clear, and exact description, reference being had to the accompanying drawing making part of this specification, in which—

Figure 1 is a perspective view of the interior of the lock with the tumblers and trunnion removed.

Figure 2 is a plan of the same with the trunnion in place.

Figure 3 is a plan representing the dog-tumbler, and its relative position to the bolt when the latter is thrown in.

Figure 4 is also a plan, showing the interior of the lock, with the several tumblers and their auxiliary tumblers in place.

Figure 5 is a section on the line *x x* of fig. 4.

Figure 6 is a plan of the front of the shell or casing.

Figure 7 is a longitudinal section through a key of my improved construction.

Figure 8 is a perspective view of the trunnion detached.

Figure 9 is a perspective view of one of the auxiliary tumblers.

My invention consists in combining and operating in a lock a stationary nuption, and a trunnion, which fits over and pivots upon the same, with dog-tumbler, bolt, short stud and key, as herein described.

To enable others skilled in the art to understand and use my invention, I will proceed to describe the manner in which I have carried it out.

In the said drawing—

*A* is the shell or casing, the front portion *a* of which (fig. 6) is made removable, and is provided with an aperture for the insertion of the key *B*, fig. 7, to be described hereafter.

*b* is the rear portion of the shell or casing, from the inside of which, and made in the same piece therewith, projects a circular "nuption" or trunnion-guide, *C*, (see fig. 1,) which is slotted through its center for the passage of and to guide the key.

Upon this "nuption" is placed the trunnion *D*, of the form shown in figs. 2 and 8, and also provided with a slot, *e*, for the entrance of the key.

*d* is the projecting arm of the trunnion, which comes in contact with and throws the bolt out and in, to lock and unlock the door.

From the front side of the trunnion, and made in the same piece therewith, projects a cam-shaped piece, *e*, over which and a short stud, *g*, rising from the bolt *E*, is fitted the first or dog-tumbler *G*, of the form shown in fig. 3, suitable recesses, 10 11, being made in the tumbler to allow of its fitting into position.

When the bolt is not thrown out, the upper edge 12 of the recess 10 rests upon the upper surface 13 of the

cam-shaped piece *e*, and the short stud *g* is within the portion *j* of the recess 11.

The second or middle tumbler *H* and the third tumbler *I* are made like each other, and are each provided with a slot, *h*, for the entrance of auxiliary tumblers *K L*, presently to be explained.

Each of the three tumblers *G H I* is provided, at either its top or bottom, with a spring, *k*, one end of which bears either on the upper or lower portion of the casing, by which construction, when the "wards" of the key act or cease to act upon the tumblers *H I*, and the cam-shaped piece *e* turns the dog-tumbler *G*, the several tumblers are free to move into the required positions to conform to the motion of the bolt, as it is thrown out and in by the trunnion *D*.

Projecting out from the inside of the bolt are four guide-pins, *l*, within which and resting upon a spring, *m*, are placed two auxiliary T-shaped tumblers, *K L*, both of which are provided with slots *n*, for the passage of a screw-pin, *o*, by which construction the portion *p* of each of the auxiliary tumblers is free to be moved up or down by and in the same direction as their respective tumblers *H I*.

*q* is a thin plate interposed between the head of the screw-pin and upper auxiliary tumbler *K*, to relieve the friction which would otherwise arise from the sliding of the said auxiliary tumblers.

*r* is also a thin plate interposed between the lower auxiliary tumbler *L* and the spring *m*, for a like purpose.

The stem of the key *B* is slotted out to admit of the reception and adjustment of a series of "bits" or "wards" therein.

These wards, when adjusted, are securely clamped by tightening a screw, *s*, which longitudinally enters the slot from the lower end of the stem.

The construction above described admits of a large number of changes, but before making a change the bolt must be thrown in.

A lock made in accordance with my invention will be found to be more strong and durable than a lock in which the trunnion bears and is revolved within the sides of the shell or casing; and further, as my trunnion is entirely inclosed by and does not project outside thereof, no instrument can be entered to turn it into a wrong position for entering the key.

Claim.

What I claim as my invention, and desire to secure by Letters Patent, is—

The combination of the nuption *C*, trunnion *D*, dog-tumbler *G*, bolt *E*, short stud *g*, and key *B*, when constructed and operated substantially as and for the purpose described.

Witnesses:

CHAS. C. DICKERMAN.

N. W. STEARNS,

P. E. TESCHEMACHER.