



US00D802456S

(12) **United States Design Patent**
Huang

(10) **Patent No.:** **US D802,456 S**

(45) **Date of Patent:** **** Nov. 14, 2017**

(54) **LEAKAGE CLAMP METER**

Primary Examiner — Antoine D Davis

(71) Applicant: **Fluke Corporation**, Everett, WA (US)

(74) *Attorney, Agent, or Firm* — Seed IP Law Group LLP

(72) Inventor: **Wei Huang**, Shanghai (CN)

(57) **CLAIM**

(73) Assignee: **Fluke Corporation**, Everett, WA (US)

The ornamental design for a leakage clamp meter, as shown and described.

(**) Term: **15 Years**

(21) Appl. No.: **29/553,931**

(22) Filed: **Feb. 5, 2016**

DESCRIPTION

(30) **Foreign Application Priority Data**

Aug. 6, 2015 (CN) 2015 3 0292978

The patent file contains at least one drawing executed in color. Copies of this patent with color drawings will be provided by the Office upon request and payment of the necessary fee.

(51) **LOC (10) Cl.** **10-04**

FIG. 1 is a bottom, front right perspective view of a leakage clamp meter showing my new design including portions shown in color.

(52) **U.S. Cl.**

USPC **D10/79**

FIG. 2 is a front elevational view thereof.

(58) **Field of Classification Search**

USPC D10/79

FIG. 3 is a rear elevational view thereof.

CPC G01R 1/04; G01R 1/0408; G01R 1/0416;

FIG. 4 is a left side elevational view thereof.

G01R 1/0425; G01R 1/06; G01R 1/067;

FIG. 5 is a right side elevational view thereof.

G01R 15/125; G01R 1/22; G01R 15/12;

FIG. 6 is a top plan view thereof.

G01R 15/18; G01R 15/186; G01R 1/07;

FIG. 7 is a bottom plan view thereof.

G01R 1/16772; G01R 1/16788

FIG. 8 is a bottom, front right perspective view of another embodiment of a leakage clamp meter showing my new design including portions shown in color.

See application file for complete search history.

FIG. 9 is a front elevational view thereof.

(56) **References Cited**

U.S. PATENT DOCUMENTS

FIG. 10 is a rear elevational view thereof.

D416,820 S * 11/1999 Tanaka D10/79

FIG. 11 is a left side elevational view thereof.

D585,316 S * 1/2009 Chang D10/79

FIG. 12 is a right side elevational view thereof.

7,530,277 B2 * 5/2009 Miyasaka G01R 1/04

FIG. 13 is a top plan view thereof; and,

7,733,080 B1 * 6/2010 Liu G01R 1/22

FIG. 14 is a bottom plan view thereof.

7,750,621 B1 * 7/2010 Liu G01R 1/06788

The broken lines immediately adjacent the colored areas represent the bounds of the claimed design. All other broken lines within the bounds illustrate environment. The broken lines form no part of the claimed design, and no claim is made regarding color within the broken lines immediately adjacent the colored areas.

324/126

324/126

D628,918 S * 12/2010 Chang D10/79

7,884,598 B2 * 2/2011 Wang G01R 1/22

324/117 H

(Continued)

1 Claim, 10 Drawing Sheets
(10 of 10 Drawing Sheet(s) Filed in Color)

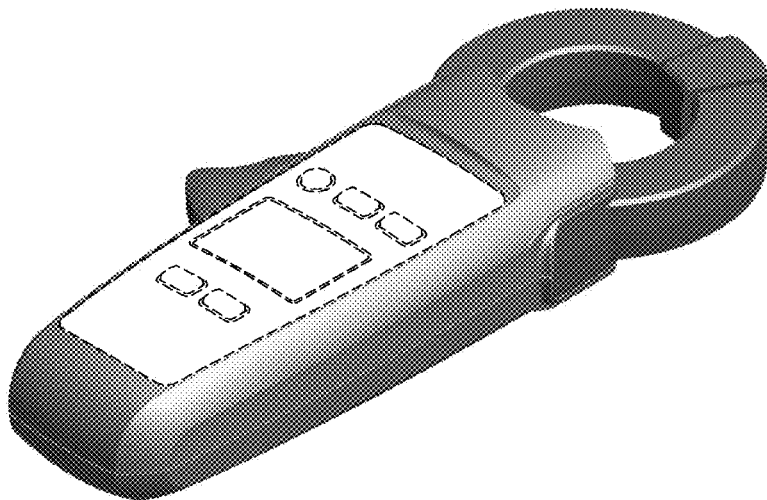

(56)

References Cited

U.S. PATENT DOCUMENTS

7,944,197 B2 * 5/2011 Shah G01R 1/22
324/115
8,120,350 B2 * 2/2012 Shah G01R 1/22
324/115
8,330,449 B2 * 12/2012 Greenberg G01R 15/12
324/115
D683,250 S * 5/2013 Marzynski D10/79
D684,074 S * 6/2013 Wei D10/79
8,570,026 B2 * 10/2013 Liu G01R 1/04
324/114
D715,169 S * 10/2014 Chen D10/79
8,856,553 B2 * 10/2014 Lyakhovitskiy G06F 21/00
380/277
8,922,195 B2 * 12/2014 Worones G01R 1/22
324/126
D726,048 S * 4/2015 Wurts D10/79
9,366,698 B2 * 6/2016 Legros G01R 1/20

* cited by examiner

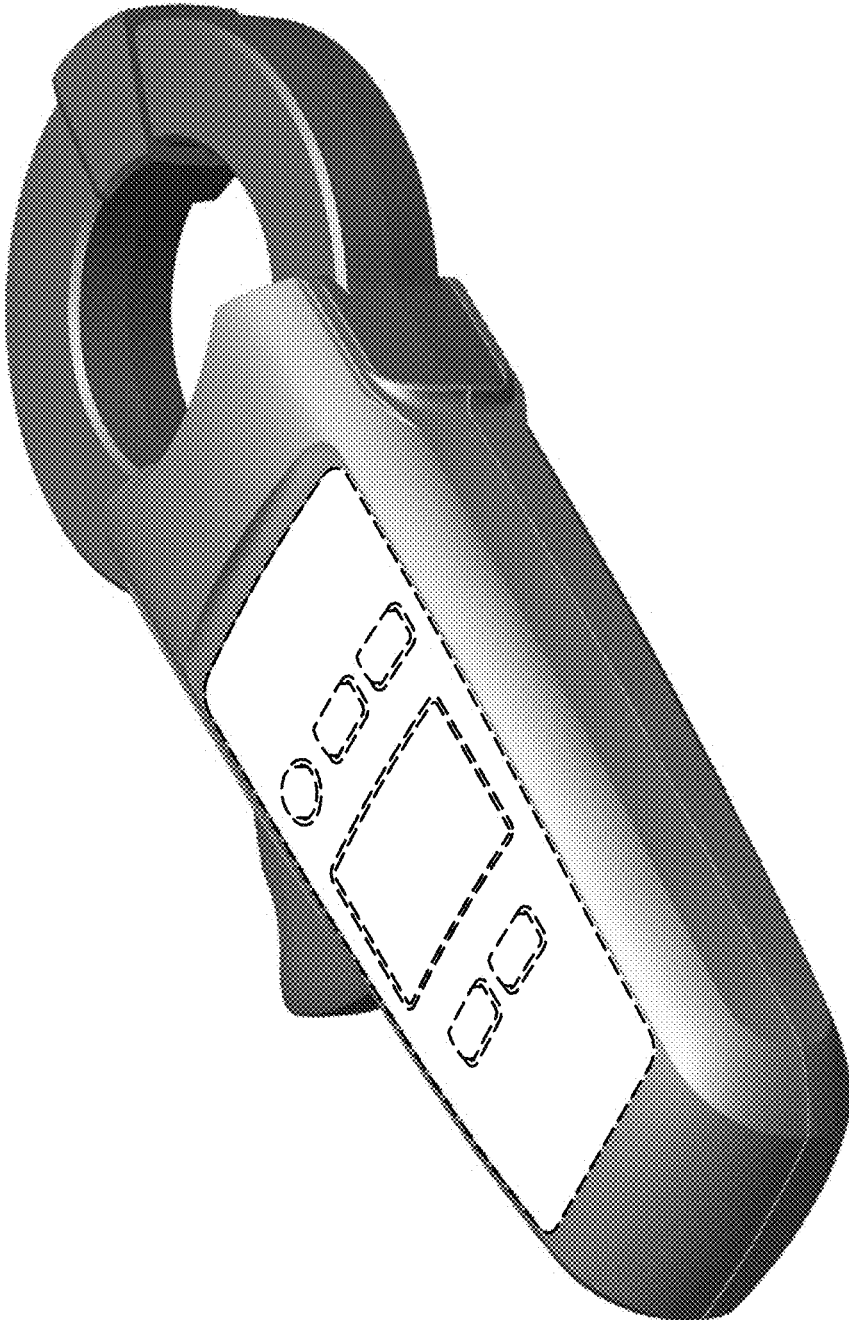

FIG.1

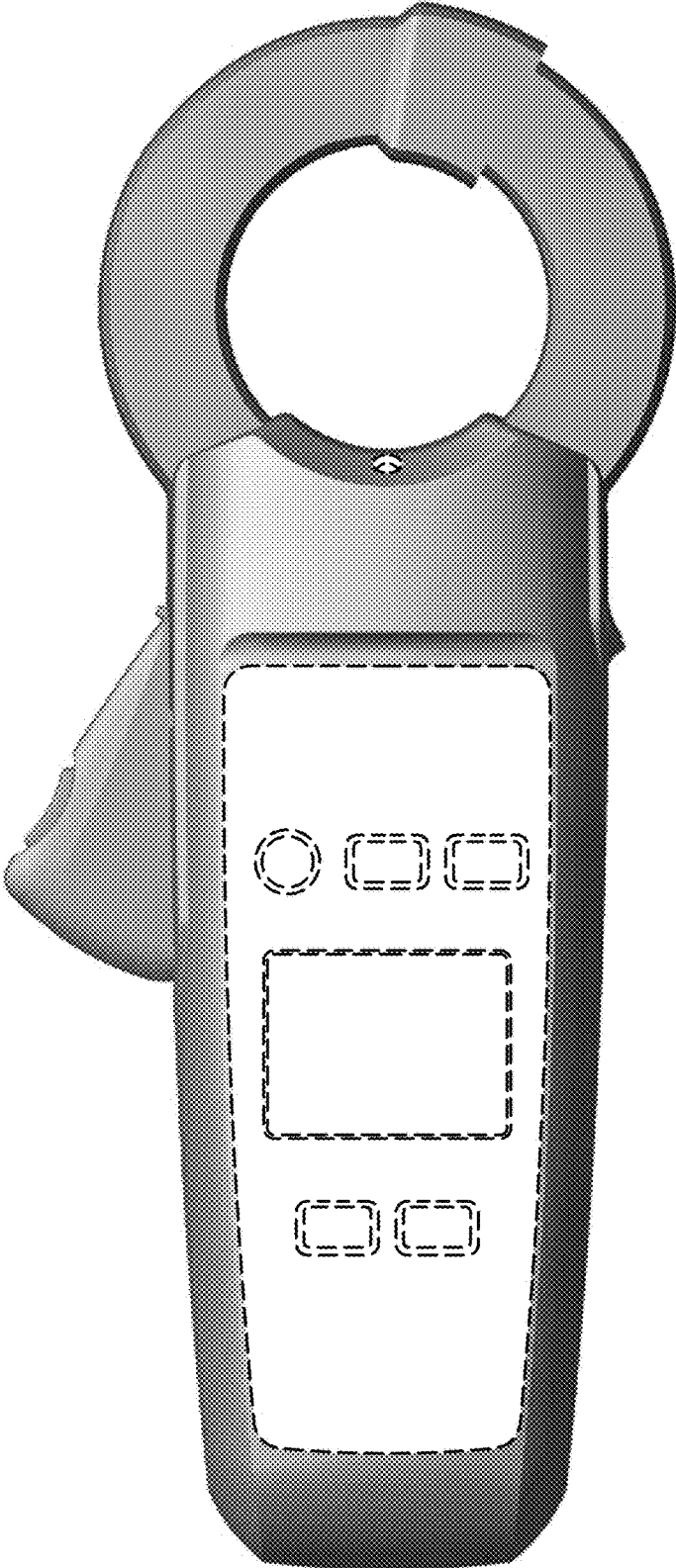

FIG.2

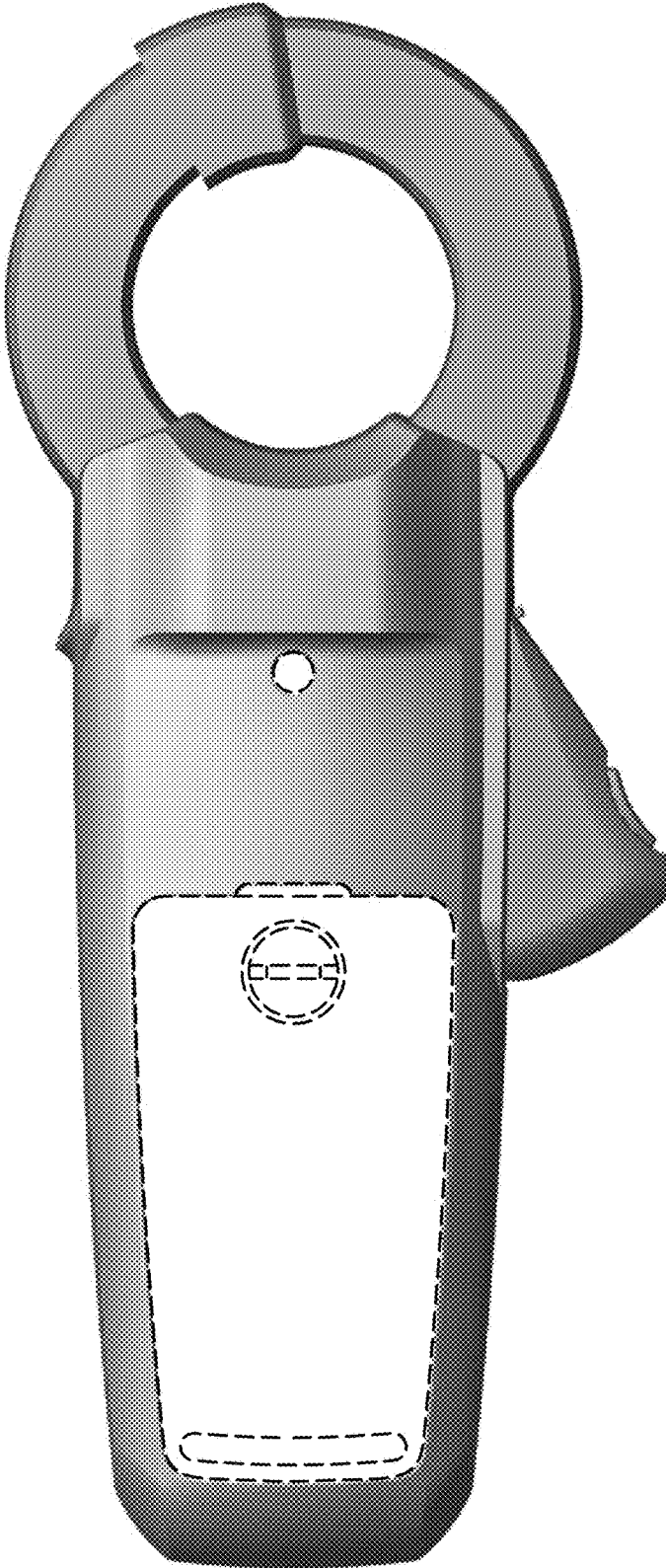

FIG.3

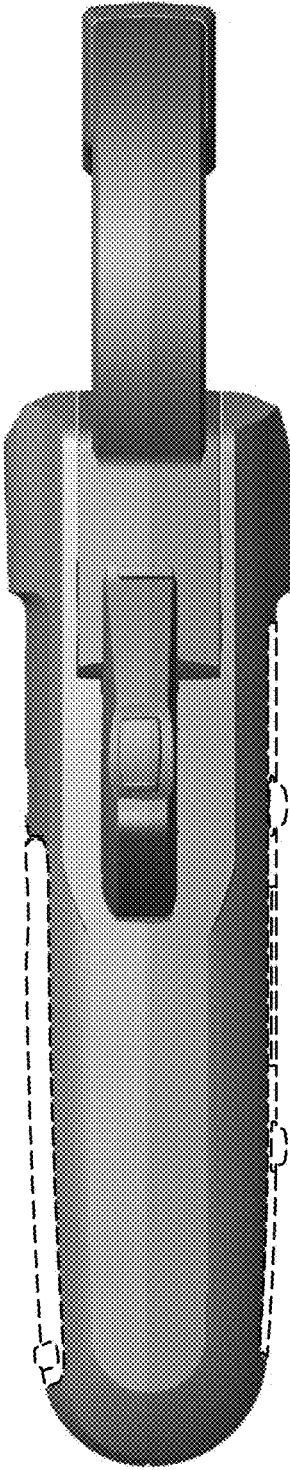

FIG.4

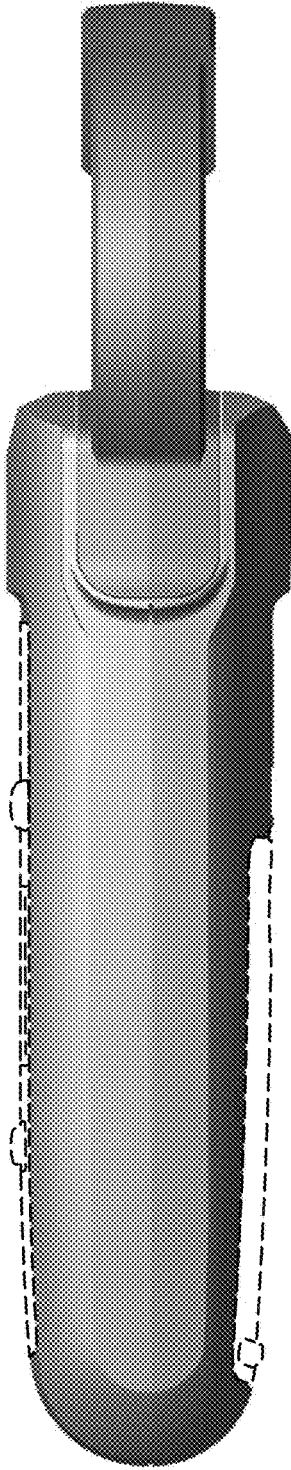

FIG.5

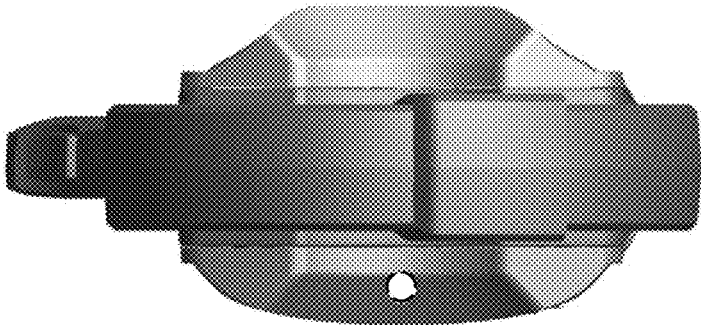

FIG.6

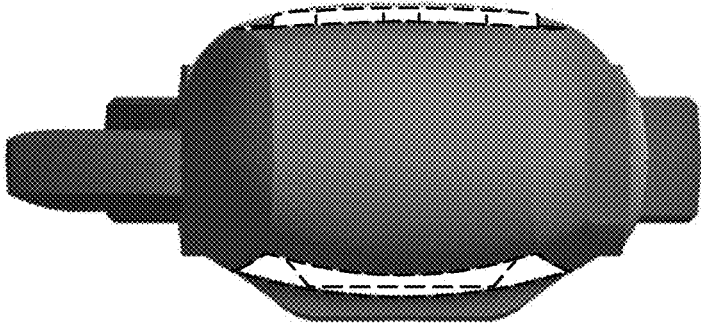

FIG.7

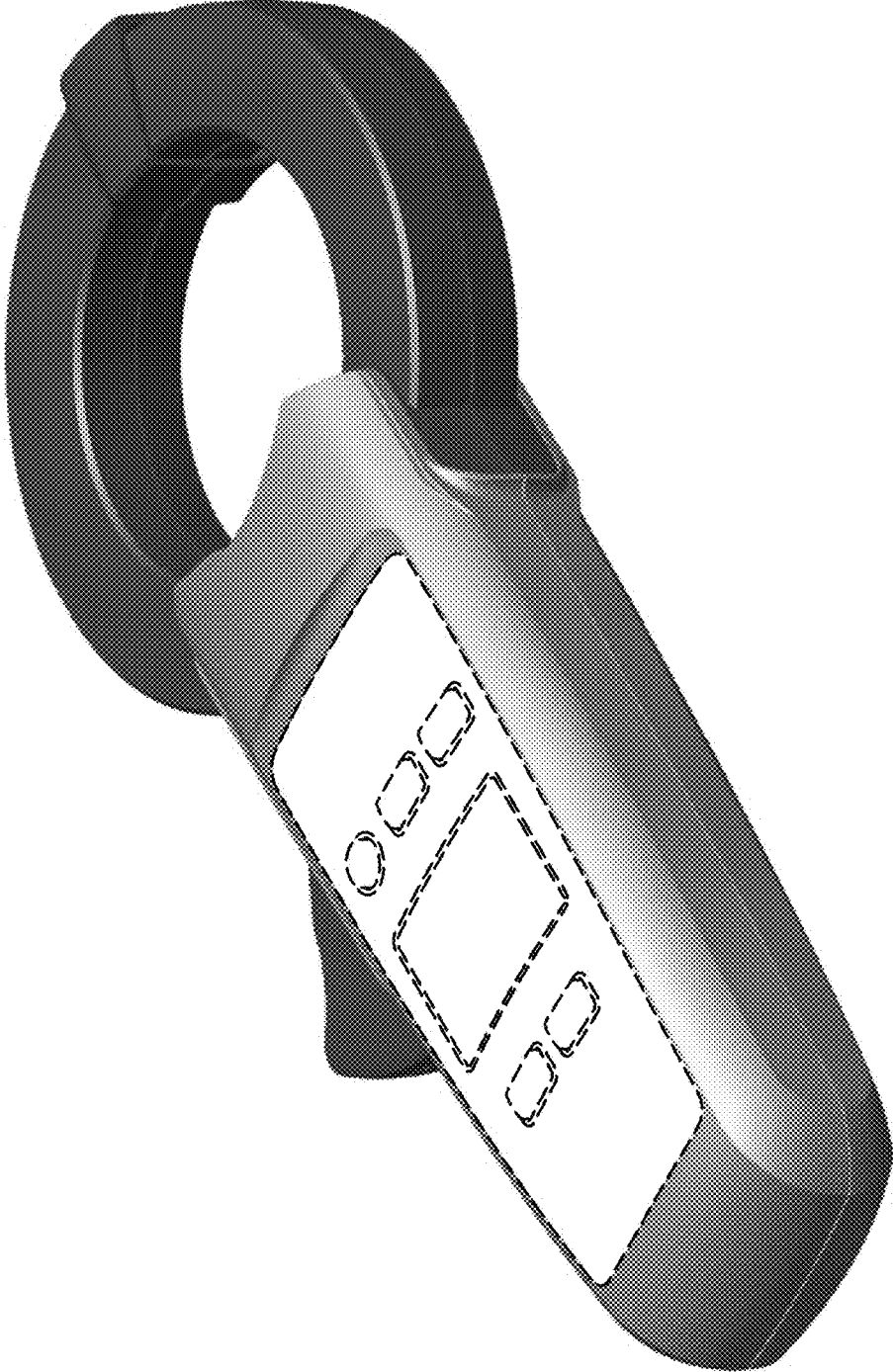

FIG.8



FIG.9



FIG.10

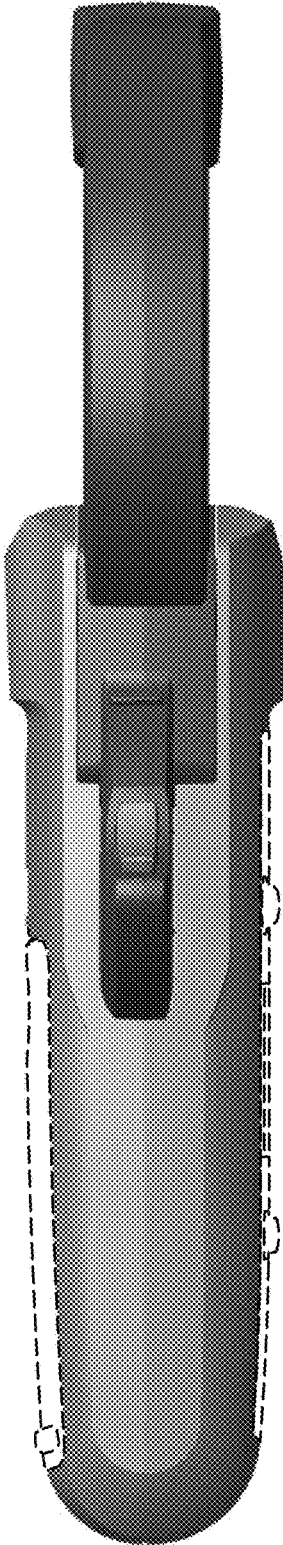

FIG. 11

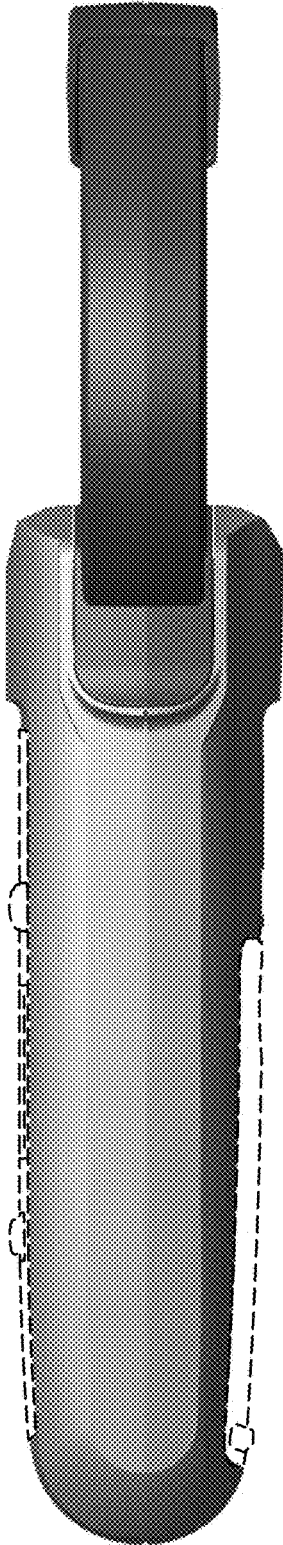

FIG. 12

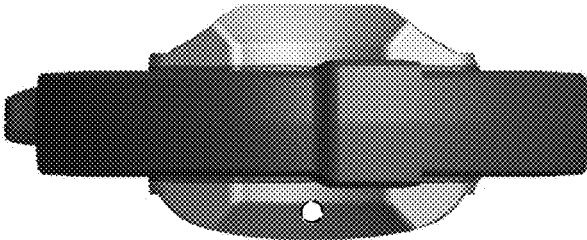

FIG.13

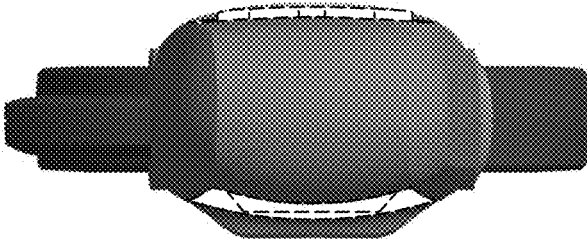

FIG.14