



US00D761001S

(12) **United States Design Patent**
Kouns et al.

(10) **Patent No.:** **US D761,001 S**
(45) **Date of Patent:** **** Jul. 12, 2016**

(54) **HAT CLIP**

(71) Applicants: **Steve Kouns**, Lebanon, IN (US); **John Kouns**, Lebanon, IN (US); **Brian King**, Lebanon, IN (US)

(72) Inventors: **Steve Kouns**, Lebanon, IN (US); **John Kouns**, Lebanon, IN (US); **Brian King**, Lebanon, IN (US)

(**) Term: **15 Years**

(21) Appl. No.: **29/531,838**

(22) Filed: **Jun. 30, 2015**

(51) **LOC (10) Cl.** **02-03**

(52) **U.S. Cl.**
USPC **D2/895**

(58) **Field of Classification Search**
USPC D2/865, 866, 872, 875, 876, 877, 878, D2/879, 880, 881, 882, 883, 884, 885, 886, D2/887, 888, 891, 893, 895; D6/315, 323, D6/325, 328; D8/38; D11/200, 201, 204, D11/207, 214, 215, 222
CPC A42B 1/00; A42B 1/004; A42B 1/24; A42B 3/04; A44B 9/00; A44B 9/02; A44B 9/04; A44B 9/06; A45F 5/06
See application file for complete search history.

6,397,396 B1 6/2002 Vibert
D461,746 S * 8/2002 Olson D11/201
6,481,059 B2 11/2002 Morris
6,618,907 B2 9/2003 Morris
6,637,074 B1 10/2003 Morris
6,644,807 B1 11/2003 Hood
6,647,554 B1 11/2003 Yan
6,671,885 B2 1/2004 Viggiano
6,688,505 B1 * 2/2004 Bradley A45F 5/02
224/194
6,691,374 B2 * 2/2004 Coyne A45F 5/02
24/3.1
6,694,526 B1 * 2/2004 Tate A42B 1/24
2/209.12
6,792,619 B1 9/2004 Morris et al.
D503,261 S 3/2005 Pedersen

(Continued)

Primary Examiner — Karen E. Eldridge Powers
Assistant Examiner — Jasmine Mlinarcik
(74) *Attorney, Agent, or Firm* — Woodard, Emhardt, Moriarty, McNett & Henry LLP

(57) **CLAIM**
The ornamental design for a hat clip, as shown and described.

DESCRIPTION

FIG. 1 is a perspective view showing the hat clip of the current design as it may appear when in use; the baseball cap and sunglasses shown in broken lines are environmental structure that forms no part of the claimed design;

FIG. 2 is a further perspective view showing the hat clip of the current design; the clip receiver shown in broken lines is environmental structure that forms no part of the claimed design;

FIG. 3 is a perspective view of the hat clip showing our new design;

FIG. 4 is a front elevational view thereof;

FIG. 5 is a back elevational view thereof;

FIG. 6 is a left side elevational view thereof;

FIG. 7 is a right side elevational view thereof;

FIG. 8 is a top plan view thereof; and,

FIG. 9 is a bottom plan view thereof.

1 Claim, 3 Drawing Sheets

(56) **References Cited**
U.S. PATENT DOCUMENTS

857,838 A	6/1907	Shaw	
3,373,444 A	3/1968	Militello	
4,179,753 A	12/1979	Aronberg et al.	
5,052,054 A	10/1991	Birum	
5,066,154 A	11/1991	Renaud	
5,373,583 A	12/1994	Birum	
5,860,167 A	1/1999	Lizio	
5,867,874 A	2/1999	Simpson	
D407,537 S *	4/1999	Simpson	D2/865
D412,611 S *	8/1999	Simpson	D2/891
5,933,871 A	8/1999	Kraft	
5,940,891 A	8/1999	Lane	
6,298,495 B1	10/2001	Totani	
6,357,642 B1 *	3/2002	Marchessault	A42B 1/24 2/209.13

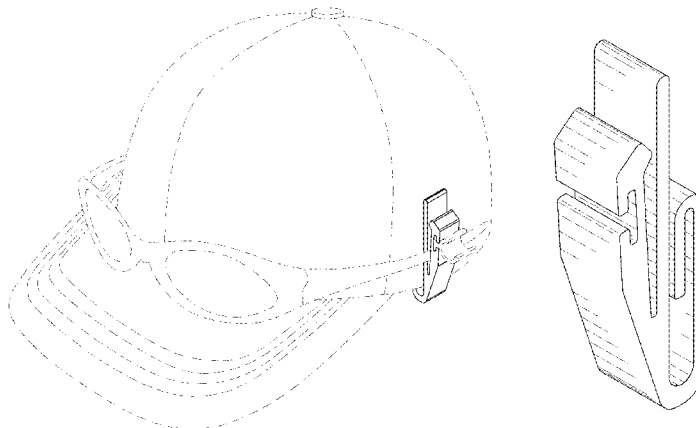

(56)

References Cited

U.S. PATENT DOCUMENTS

6,892,393 B1	5/2005	Provost et al.	8,381,359 B1	2/2013	McArdle	
7,003,809 B1	2/2006	Gordon	8,418,271 B2	4/2013	Hardy	
7,013,491 B2	3/2006	Ferrara	8,545,041 B2 *	10/2013	Brown	A42B 1/24
7,137,151 B2	11/2006	Keech				24/336
7,165,273 B1	1/2007	Redmond	8,573,773 B1	11/2013	Acosta	
7,229,172 B2	6/2007	Presswood, Jr. et al.	8,740,379 B2	6/2014	Berger	
7,240,370 B2	7/2007	Lerner	2005/0108857 A1	5/2005	Wartian et al.	
7,255,436 B2	8/2007	Tracy	2005/0223525 A1	10/2005	Wartian et al.	
7,275,270 B2	10/2007	Cotutsca	2006/0152671 A1	7/2006	Risso et al.	
7,340,781 B2	3/2008	Clark	2008/0054033 A1	3/2008	Synness	
D570,247 S *	6/2008	Hajianpour	2008/0120763 A1	5/2008	Clark	
7,470,022 B2	12/2008	Lerner	2008/0263839 A1	10/2008	Stillwell	
7,484,845 B2	2/2009	Douglas	2008/0295295 A1 *	12/2008	Rogers	A42B 1/24
D619,360 S *	7/2010	Ledford	2010/0122399 A1	5/2010	Odom	24/3.12
7,866,813 B2 *	1/2011	Anhalt	2011/0088144 A1	4/2011	Thomas	
		2/209.13	2011/0126343 A1	6/2011	Tualla et al.	
7,904,970 B2	3/2011	Thomas	2011/0219508 A1	9/2011	Hill	
D639,707 S *	6/2011	Caskey	2011/0247120 A1	10/2011	Knoedler	
7,954,943 B2	6/2011	Ledford	2011/0314580 A1	12/2011	Vach	
7,979,921 B2	7/2011	Cotutsca	2012/0272483 A1	11/2012	Moore	
8,209,778 B2	7/2012	Matsumoto	2013/0318673 A1	12/2013	Huh	
8,210,676 B1	7/2012	Hunt	2014/0063443 A1	3/2014	Berger	
			2015/0013114 A1	1/2015	Grame et al.	
			2015/0098055 A1	4/2015	Tahsler et al.	

* cited by examiner

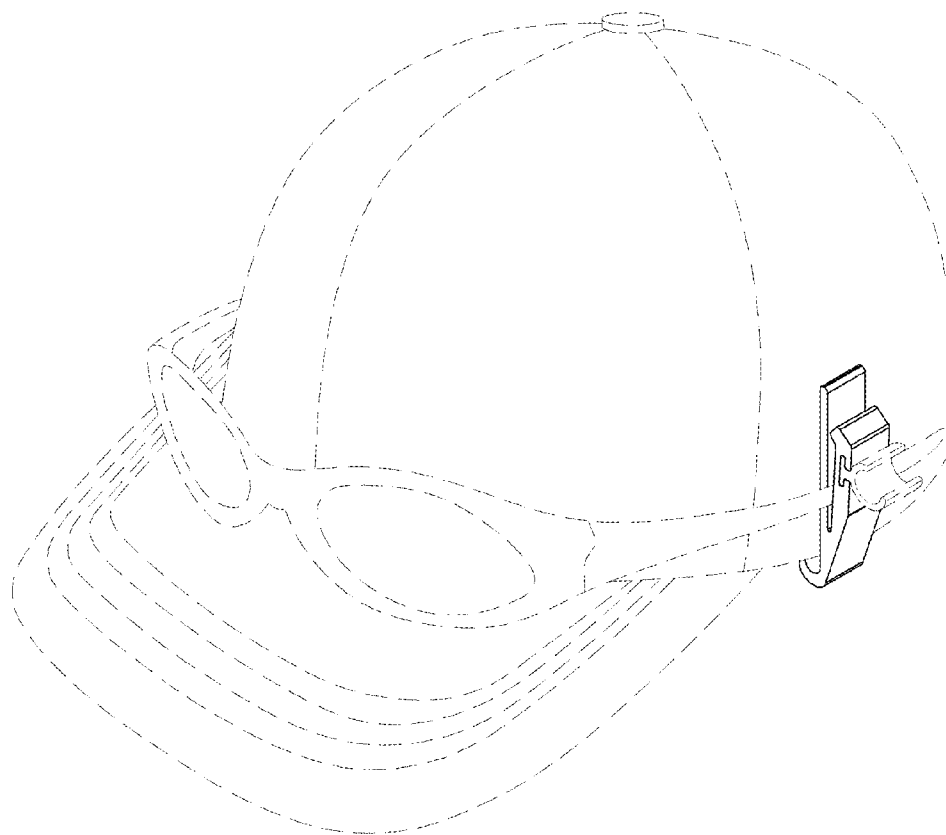

Fig. 1

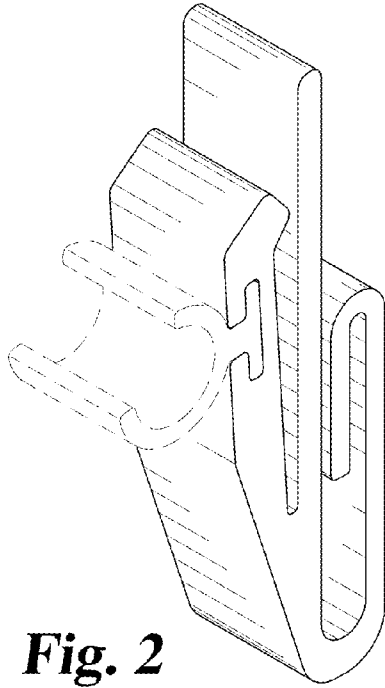

Fig. 2

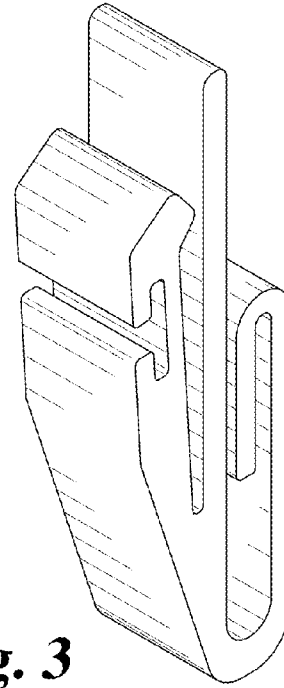

Fig. 3

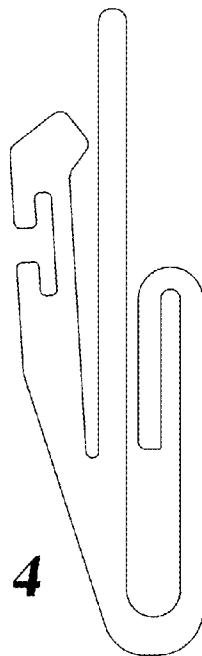

Fig. 4

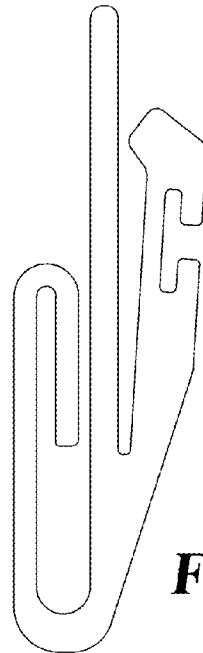

Fig. 5

Fig. 6

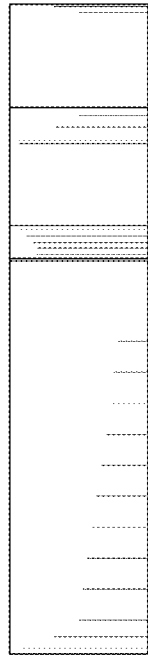

Fig. 7

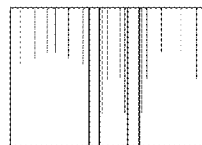
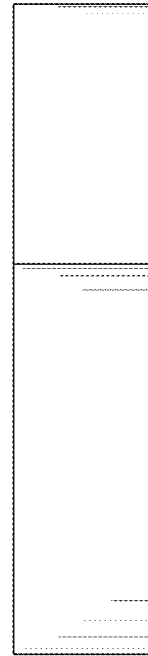

Fig. 8

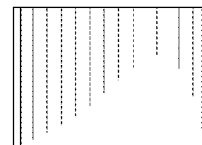

Fig. 9