



US00D376325S

United States Patent [19]

[11] Patent Number: Des. 376,325

Blauch et al.

[45] Date of Patent: **Dec. 10, 1996

[54] FOOT MEASURING DEVICE

3,579,837 5/1971 Soriano 33/3 B

[76] Inventors: **Kevan K. Blauch**, 22 Buch Ave., Lancaster, Pa. 17601; **Timothy Hertzog**, 256 N. 11th St., Akron, Pa. 17501

Primary Examiner—Antoine Duval Davis
Attorney, Agent, or Firm—Harpman & Harpman

[**] Term: 14 Years

[57] CLAIM

The ornamental design for a foot measuring device, as shown and described.

[21] Appl. No.: 47,750

DESCRIPTION

[22] Filed: Dec. 12, 1995

[52] U.S. Cl. D10/70; D10/93

FIG. 1 is a front, top and side perspective view of the foot measuring device embodying the design of the present invention;

[58] Field of Search D10/70, 93; 33/3 A, 33/3 B, 3 C; 177/238-245

FIG. 2 is a front elevational view thereof;

FIG. 3 is a rear elevational view thereof;

[56] References Cited

U.S. PATENT DOCUMENTS

D. 142,055	8/1945	Barok	D10/93
D. 207,738	5/1967	Saad	D10/70
3,192,627	7/1965	Levitt et al.	33/3 C
3,328,882	7/1967	Blivice	33/3 C

FIG. 4 is a side elevational view thereof, the opposite side elevational view being identical thereto;

FIG. 5 is a top plan view thereof; and,

FIG. 6 is a bottom plan view thereof.

1 Claim, 4 Drawing Sheets

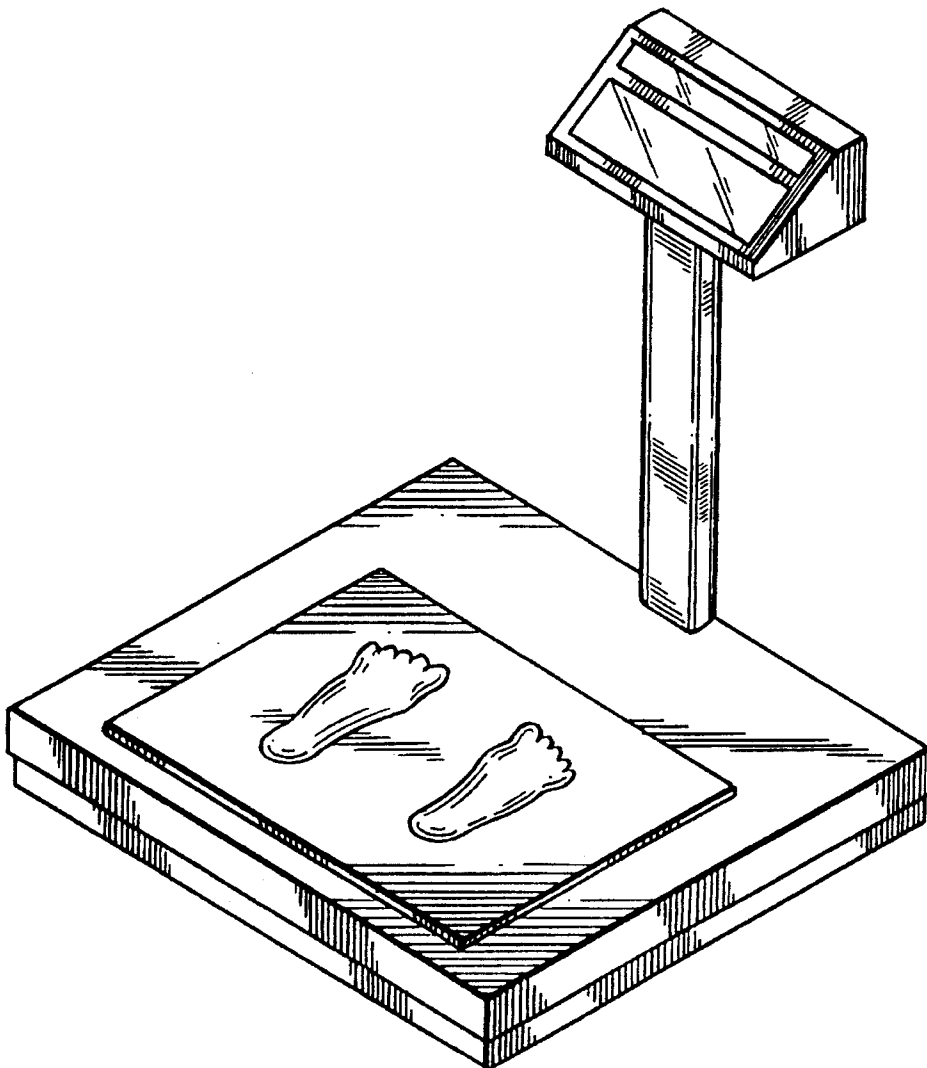

FIG. 1.

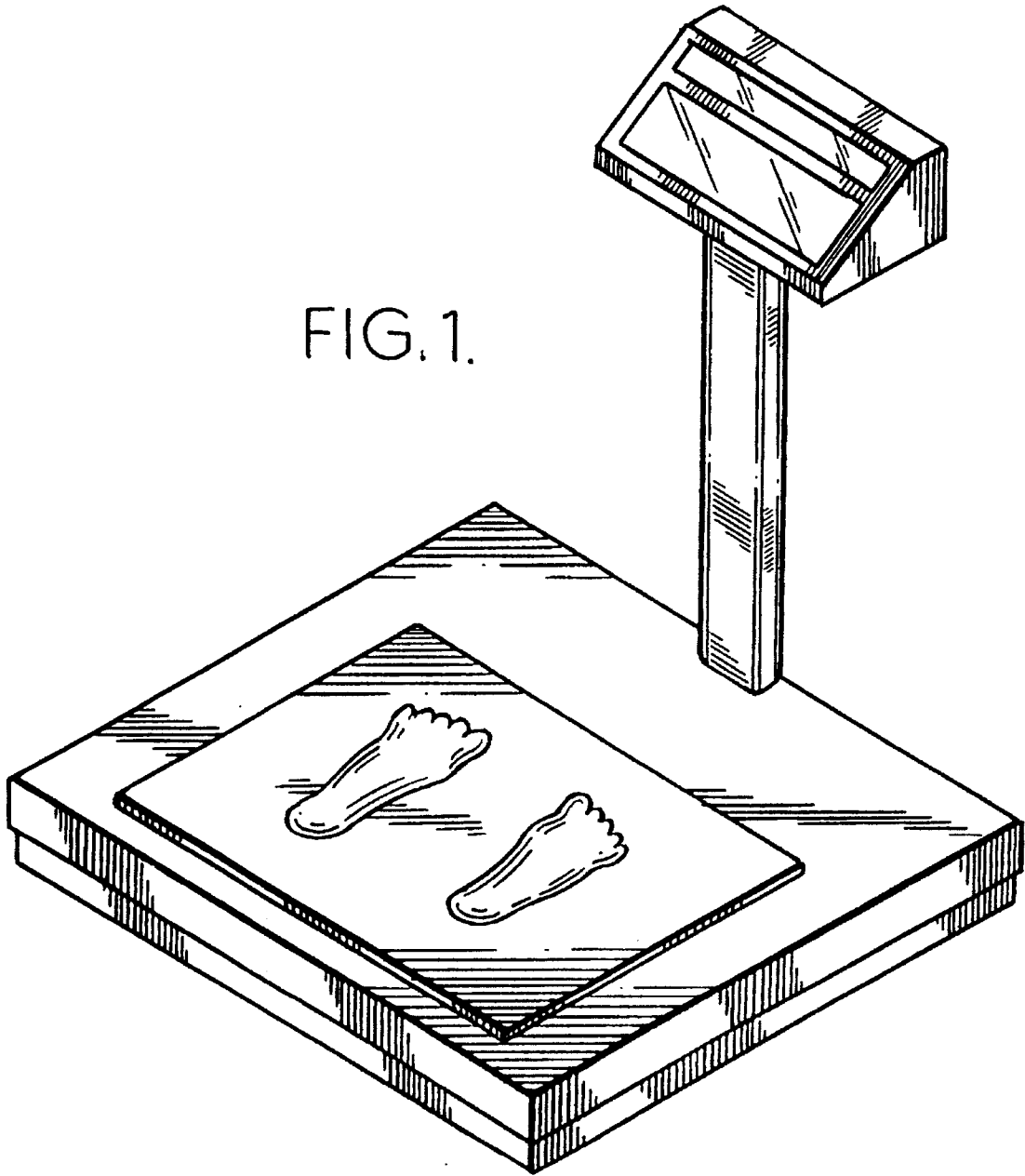

FIG. 2.

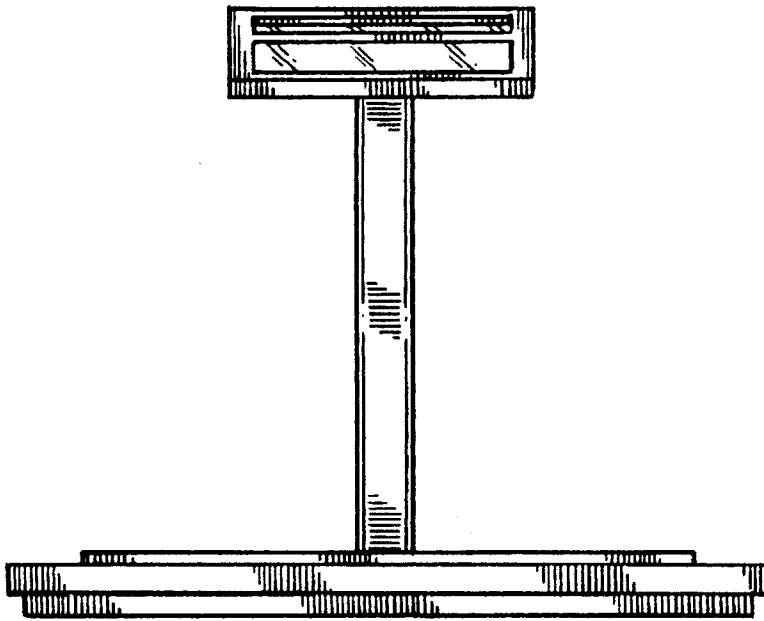
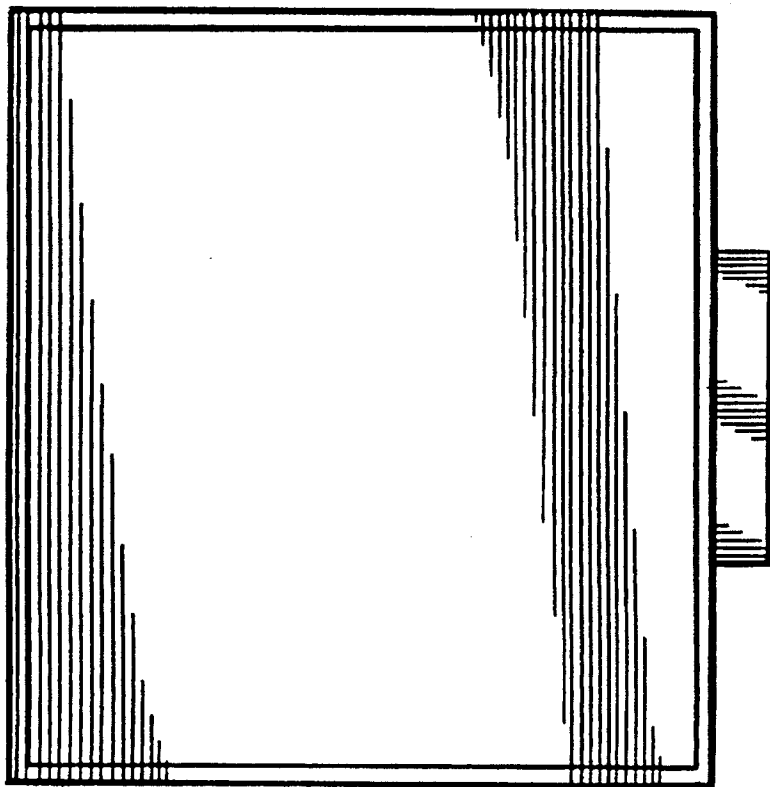

FIG. 6.



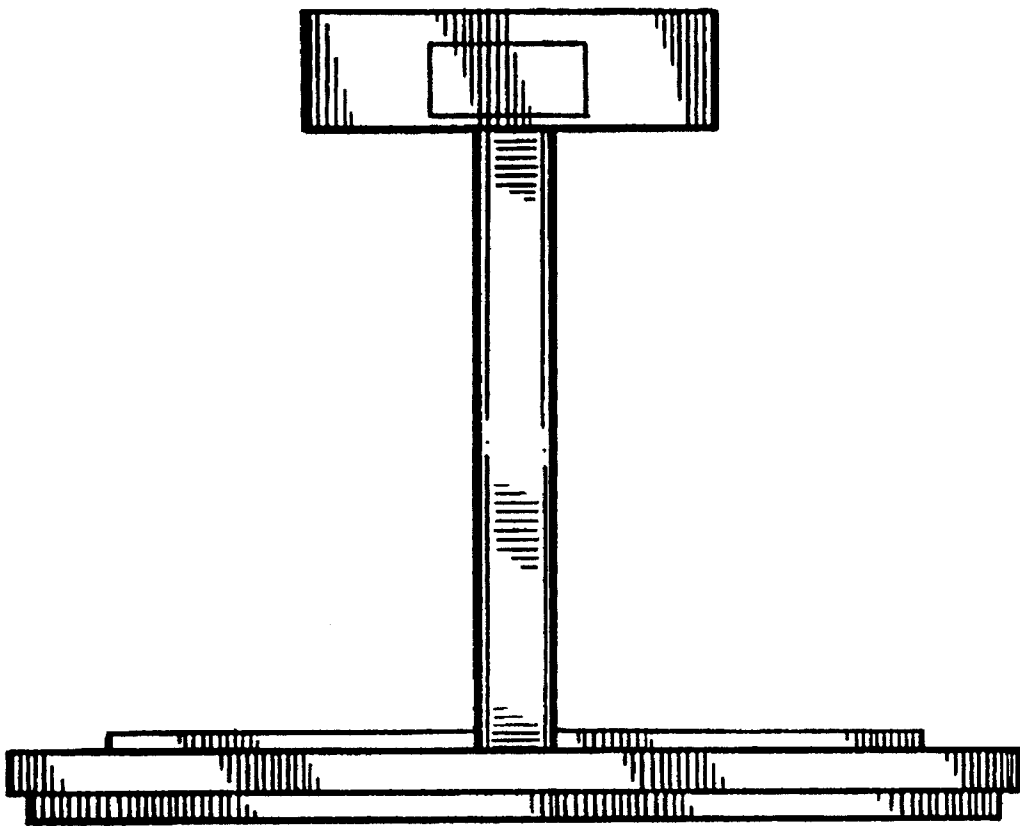

FIG. 3.

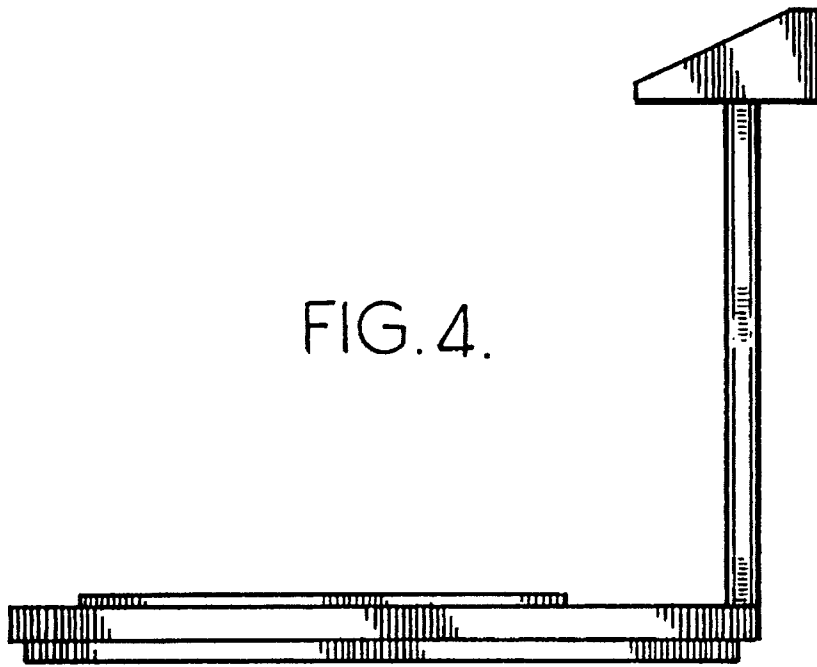

FIG. 4.

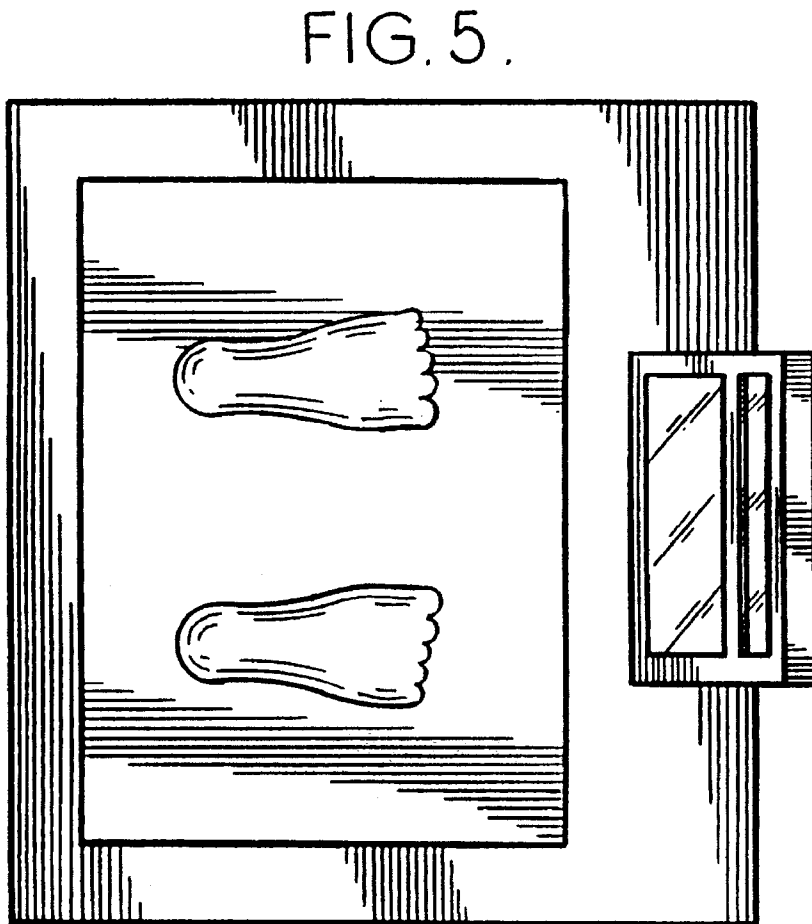

FIG. 5.