



US00D746926S

(12) **United States Design Patent**
Parsons et al.

(10) **Patent No.:** **US D746,926 S**

(45) **Date of Patent:** **** Jan. 5, 2016**

(54) **GOLF CLUB HEAD**

Primary Examiner — Mitchell Siegel

(71) Applicant: **PARSONS XTREME GOLF, LLC**,
Scottsdale, AZ (US)

(57) **CLAIM**

The ornamental design for a golf club head, as shown and described.

(72) Inventors: **Robert R. Parsons**, Scottsdale, AZ (US); **Michael R. Nicolette**, Scottsdale, AZ (US); **Bradley D. Schweigert**, Anthem, AZ (US)

DESCRIPTION

(73) Assignee: **PARSONS XTREME GOLF, LLC**,
Scottsdale, AZ (US)

(**) Term: **15 Years**

(21) Appl. No.: **29/540,066**

(22) Filed: **Sep. 21, 2015**

FIG. 1 is a top perspective view of a golf club head;
FIG. 2 is a bottom perspective view of the golf club head of FIG. 1;
FIG. 3 is a front elevational view of the golf club head of FIG. 1;
FIG. 4 is a rear elevational view of the golf club head of FIG. 1;
FIG. 5 is a top view of the golf club head of FIG. 1;
FIG. 6 is a bottom view of the golf club head of FIG. 1;
FIG. 7 is a left side view of the golf club head of FIG. 1;
FIG. 8 is a right side view of the golf club head of FIG. 1;
FIG. 9 is a top perspective view of a second embodiment of the golf club head;
FIG. 10 is a bottom perspective view of the golf club head of FIG. 9;
FIG. 11 is a front elevational view of the golf club head of FIG. 9;
FIG. 12 is a rear elevational view of the golf club head of FIG. 9;
FIG. 13 is a top view of the golf club head of FIG. 9;
FIG. 14 is a bottom view of the golf club head of FIG. 9;
FIG. 15 is a left side view of the golf club head of FIG. 9;
FIG. 16 is a right side view of the golf club head of FIG. 9;
FIG. 17 is a top perspective view of a third embodiment of the golf club head;
FIG. 18 is a bottom perspective view of the golf club head of FIG. 17;
FIG. 19 is a front elevational view of the golf club head of FIG. 17;
FIG. 20 is a rear elevational view of the golf club head of FIG. 17;
FIG. 21 is a top view of the golf club head of FIG. 17;
FIG. 22 is a bottom view of the golf club head of FIG. 17;
FIG. 23 is a left side view of the golf club head of FIG. 17;
and,
FIG. 24 is a right side view of the golf club head of FIG. 17.
The broken lines connecting the solid lines represent the bounds of the claim. The remaining broken lines illustrate the environment. None of the broken lines forms part of the claimed design.

Related U.S. Application Data

(63) Continuation-in-part of application No. 29/537,413, filed on Aug. 25, 2015.

(51) **LOC (10) Cl.** **21-02**

(52) **U.S. Cl.**
USPC **D21/747**

(58) **Field of Classification Search**
USPC D21/747-751, 759
CPC A63B 53/00; A63B 53/04; A63B 53/047;
A63B 53/0475

See application file for complete search history.

(56) **References Cited**

U.S. PATENT DOCUMENTS

1,133,129 A * 3/1915 Govan 473/337
D164,469 S 9/1951 Behrendt

(Continued)

OTHER PUBLICATIONS

U.S. Appl. No. 29/511,482, Nicolette et al., "Golf Club Head," filed Dec. 11, 2014.

(Continued)

1 Claim, 21 Drawing Sheets

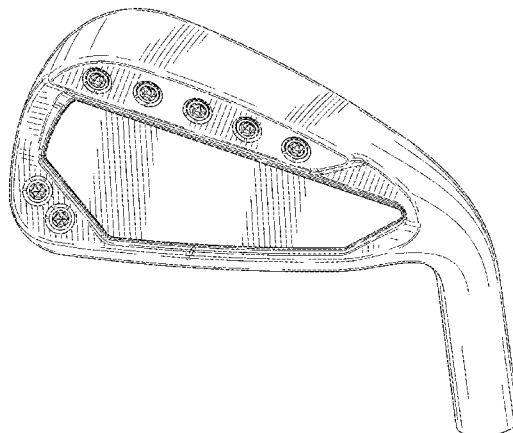

(56)

References Cited

U.S. PATENT DOCUMENTS

3,020,048 A	2/1962	Carroll		D508,099 S	8/2005	Schweigert et al.	
D203,936 S	3/1966	Long		D508,545 S	8/2005	Roberts et al.	
D215,101 S	9/1969	Sabat		6,923,733 B2	8/2005	Chen	
D234,963 S	4/1975	Hirata		D514,183 S	1/2006	Schweigert et al.	
D239,550 S	4/1976	Timbrook		D516,650 S	3/2006	Wolfe et al.	
D240,054 S	5/1976	Meissler		D518,863 S	4/2006	Motoyoshi et al.	
D261,167 S	10/1981	Swanson		D523,501 S	6/2006	Nicolette et al.	
D294,617 S *	3/1988	Perkins	D21/749	D523,917 S	6/2006	Wolfe et al.	
4,754,977 A	7/1988	Sahm		D524,889 S	7/2006	Yu et al.	
4,824,116 A	4/1989	Nagamoto et al.		D530,759 S	10/2006	Nicolette et al.	
4,988,104 A	1/1991	Shiotani et al.		D530,760 S	10/2006	Schweigert et al.	
5,158,296 A *	10/1992	Lee	473/327	7,121,956 B2 *	10/2006	Lo	473/335
5,176,384 A	1/1993	Sata et al.		7,128,663 B2	10/2006	Bamber	
5,213,328 A	5/1993	Long et al.		D532,849 S	11/2006	Nicolette et al.	
D336,672 S	6/1993	Gorman		D534,228 S	12/2006	Nicolette et al.	
D353,862 S	12/1994	Saito		D534,595 S *	1/2007	Hasebe	D21/747
D357,520 S	4/1995	Helmstetter et al.		D534,597 S	1/2007	Nicolette et al.	
5,419,560 A	5/1995	Bamber		7,156,751 B2	1/2007	Wahl et al.	
5,425,535 A	6/1995	Gee		D536,759 S	2/2007	Schweigert et al.	
D361,358 S	8/1995	Simmons		D537,494 S	2/2007	Jertson et al.	
5,447,311 A	9/1995	Violaz et al.		7,182,698 B2	2/2007	Tseng	
5,451,056 A	9/1995	Manning		D538,366 S	3/2007	Nicolette et al.	
D362,884 S	10/1995	Blough et al.		D539,864 S	4/2007	Nicolette et al.	
D362,885 S	10/1995	Blough et al.		D540,898 S	4/2007	Solheim et al.	
D362,887 S	10/1995	Blough et al.		D541,360 S	4/2007	Schweigert et al.	
D370,514 S	6/1996	Blough et al.		7,207,900 B2	4/2007	Nicolette et al.	
5,540,437 A	7/1996	Bamber		D543,601 S *	5/2007	Kawami	D21/759
D379,106 S *	5/1997	Maltby	D21/748	D544,056 S	6/2007	Nicolette et al.	
5,637,045 A	6/1997	Igarashi		D547,410 S	7/2007	Nicolette et al.	
5,669,830 A	9/1997	Bamber		D555,219 S *	11/2007	Lin	D21/759
D389,541 S	1/1998	Huan-Chiang		7,303,486 B2	12/2007	Imamoto	
D395,476 S	6/1998	Pond et al.		D559,932 S	1/2008	Belmont	
5,766,091 A	6/1998	Humphrey et al.		D561,855 S	2/2008	Schweigert et al.	
5,766,092 A	6/1998	Mimeur et al.		D562,925 S	2/2008	Schweigert et al.	
D399,277 S	10/1998	Ezaki		7,351,164 B2	4/2008	Schweigert et al.	
5,827,132 A	10/1998	Bamber		D570,435 S	6/2008	Sanchez et al.	
D408,485 S *	4/1999	Takahashi et al.	D21/747	D570,935 S	6/2008	Nicolette et al.	
5,899,821 A	5/1999	Hsu et al.		D570,936 S	6/2008	Schweigert et al.	
5,935,016 A	8/1999	Antonious		D570,942 S	6/2008	Chen et al.	
D414,535 S	9/1999	Mertens		D571,422 S	6/2008	Schweigert et al.	
D421,080 S *	2/2000	Chen	D21/747	D571,425 S	6/2008	Chen et al.	
D426,276 S *	6/2000	Besnard et al.	D21/747	D571,427 S	6/2008	Schweigert et al.	
D426,476 S	6/2000	Goss		D571,881 S	6/2008	Nicolette et al.	
6,077,171 A *	6/2000	Yoneyama	473/291	D572,326 S	7/2008	Schweigert et al.	
D442,659 S	5/2001	Kubica et al.		D572,329 S	7/2008	Nicolette et al.	
D443,008 S	5/2001	Kubica et al.		D573,219 S	7/2008	Schweigert et al.	
D445,862 S	7/2001	Ford		7,396,299 B2	7/2008	Nicolette et al.	
6,290,609 B1	9/2001	Takeda		7,413,518 B2	8/2008	Cole et al.	
D449,866 S	10/2001	Miller		D577,783 S	9/2008	Schweigert et al.	
D457,211 S	5/2002	Bakke		D578,590 S	10/2008	Schweigert et al.	
D458,328 S	6/2002	Solheim et al.		D581,000 S	11/2008	Nicolette et al.	
D469,833 S	2/2003	Roberts et al.		D581,004 S	11/2008	Schweigert et al.	
D473,605 S	4/2003	Petersen et al.		D584,370 S	1/2009	Cleveland et al.	
D475,107 S	5/2003	Madore		D594,518 S	6/2009	Schweigert	
D476,048 S	6/2003	Cleveland et al.		D596,256 S	7/2009	Schweigert et al.	
D478,949 S	8/2003	DeLaCruz		D596,257 S	7/2009	Jertson et al.	
6,638,182 B2	10/2003	Kosmatka		D596,258 S	7/2009	Jertson et al.	
6,695,714 B1	2/2004	Bliss et al.		D596,688 S	7/2009	Schweigert et al.	
6,702,693 B2	3/2004	Bamber		D597,158 S	7/2009	Schweigert et al.	
D492,376 S	6/2004	Nicolette et al.		D601,216 S	9/2009	Jertson et al.	
D494,240 S	8/2004	Schweigert		7,588,502 B2	9/2009	Nishino	
D494,648 S	8/2004	Schweigert et al.		7,601,075 B2	10/2009	Cole et al.	
6,780,123 B2	8/2004	Hasebe		D604,783 S	11/2009	Nicolette et al.	
D497,963 S	11/2004	Toulon et al.		7,611,424 B2	11/2009	Nagai et al.	
6,811,496 B2	11/2004	Wahl et al.		D606,605 S	12/2009	Wada et al.	
D499,779 S	12/2004	Mahaffey et al.		D607,070 S	12/2009	Wada et al.	
D500,350 S	12/2004	Schweigert et al.		D607,071 S	12/2009	Wada et al.	
D500,351 S	12/2004	Schweigert et al.		7,658,686 B2	2/2010	Soracco	
D502,237 S	2/2005	Schweigert et al.		D612,438 S	3/2010	Carlyle et al.	
D502,975 S	3/2005	Schweigert et al.		D612,439 S	3/2010	Carlyle et al.	
D503,204 S	3/2005	Nicolette et al.		D617,406 S	6/2010	Carlyle et al.	
D504,925 S	5/2005	Schweigert et al.		D618,293 S	6/2010	Foster et al.	
D505,171 S	5/2005	Schweigert et al.		7,736,243 B2	6/2010	Sanchez et al.	
D507,320 S	7/2005	Roberts et al.		7,744,484 B1	6/2010	Chao	
D507,614 S	7/2005	Schweigert et al.		D621,893 S	8/2010	Nicolette et al.	
				D621,894 S	8/2010	Schweigert	
				D621,895 S	8/2010	Schweigert et al.	
				7,798,917 B2	9/2010	Nguyen et al.	
				7,815,521 B2	10/2010	Ban et al.	

(56)

References Cited

U.S. PATENT DOCUMENTS

D627,409 S 11/2010 Schweigert et al.
 D627,410 S 11/2010 Nicolette et al.
 7,846,040 B2 12/2010 Ban
 D633,159 S * 2/2011 Holt et al. D21/747
 D633,967 S 3/2011 Carlyle et al.
 D635,627 S 4/2011 Nicolette
 7,938,738 B2 5/2011 Roach
 D642,642 S 8/2011 Jertson et al.
 D643,488 S * 8/2011 Holt et al. D21/747
 D643,490 S 8/2011 Wada et al.
 D643,491 S 8/2011 Stokke et al.
 D643,492 S 8/2011 Nicolette et al.
 D643,895 S * 8/2011 Wieland D21/747
 D643,896 S 8/2011 Jertson et al.
 D647,582 S 10/2011 Nicolette et al.
 D649,211 S 11/2011 Jertson et al.
 8,062,150 B2 11/2011 Gilbert et al.
 D651,268 S 12/2011 Nicolette et al.
 8,088,025 B2 1/2012 Wahl et al.
 8,092,319 B1 1/2012 Cackett et al.
 8,105,180 B1 1/2012 Cackett et al.
 8,142,307 B2 3/2012 Sanchez et al.
 D658,248 S 4/2012 Nunez et al.
 8,221,262 B1 7/2012 Cackett et al.
 8,246,487 B1 8/2012 Cackett et al.
 D670,775 S 11/2012 Jertson et al.
 D672,417 S 12/2012 Jertson et al.
 8,328,662 B2 12/2012 Nakamura et al.
 D673,633 S 1/2013 Jertson et al.
 D673,634 S 1/2013 Jertson et al.
 8,376,878 B2 2/2013 Bennett et al.
 D680,603 S 4/2013 Nicolette et al.
 D681,142 S 4/2013 Fossum et al.
 D681,143 S 4/2013 Nicolette et al.
 8,414,422 B2 4/2013 Peralta et al.
 8,506,420 B2 8/2013 Hocknell et al.
 8,545,343 B2 10/2013 Boyd et al.
 8,574,094 B2 11/2013 Nicolette et al.
 8,657,700 B2 2/2014 Nicolette et al.
 8,663,026 B2 3/2014 Blowers et al.
 8,690,710 B2 4/2014 Nicolette et al.
 D707,316 S 6/2014 Aguayo et al.
 D707,317 S 6/2014 Aguayo et al.
 8,753,230 B2 6/2014 Stokke et al.
 D708,688 S 7/2014 Nicolette et al.
 8,827,832 B2 9/2014 Breier et al.
 8,827,833 B2 9/2014 Amano et al.
 8,845,455 B2 9/2014 Ban et al.
 D716,387 S 10/2014 Aguayo et al.
 D716,388 S 10/2014 Aguayo et al.
 D722,352 S * 2/2015 Nicolette et al. D21/747
 D723,120 S * 2/2015 Nicolette D21/747
 8,961,336 B1 2/2015 Parsons et al.
 D726,265 S * 4/2015 Nicolette D21/747
 2002/0107087 A1 8/2002 Fagot
 2003/0139226 A1 * 7/2003 Cheng et al. 473/334
 2003/0176231 A1 9/2003 Hasebe
 2004/0204263 A1 10/2004 Fagot et al.
 2005/0009632 A1 1/2005 Schweigert et al.

2005/0014573 A1 1/2005 Lee
 2005/0096148 A1 5/2005 Noble et al.
 2005/0119066 A1 6/2005 Stites et al.
 2005/0239569 A1 10/2005 Best et al.
 2005/0277485 A1 * 12/2005 Hou et al. 473/332
 2006/0111200 A1 5/2006 Poynor
 2007/0032308 A1 2/2007 Fagot et al.
 2007/0225084 A1 9/2007 Schweigert et al.
 2008/0058113 A1 3/2008 Nicolette et al.
 2008/0188322 A1 8/2008 Anderson et al.
 2008/0300065 A1 12/2008 Schweigert
 2009/0029790 A1 1/2009 Nicolette et al.
 2010/0130306 A1 5/2010 Schweigert
 2010/0178999 A1 7/2010 Nicolette et al.
 2011/0111883 A1 5/2011 Cackett
 2011/0165963 A1 7/2011 Cackett et al.
 2011/0269567 A1 11/2011 Ban et al.
 2011/0294596 A1 12/2011 Ban
 2013/0137532 A1 5/2013 Deshmukh et al.
 2013/0225319 A1 8/2013 Kato
 2013/0281226 A1 10/2013 Ban
 2013/0288823 A1 10/2013 Hebreo
 2013/0303303 A1 11/2013 Ban
 2013/0310192 A1 11/2013 Wahl et al.
 2014/0080621 A1 3/2014 Nicolette et al.
 2014/0128175 A1 5/2014 Jertson et al.
 2014/0274441 A1 9/2014 Greer
 2014/0274451 A1 9/2014 Knight et al.
 2015/0231454 A1 8/2015 Parsons et al.
 2015/0231806 A1 8/2015 Parsons et al.

OTHER PUBLICATIONS

U.S. Appl. No. 14/618,501, Parsons et al., "Golf Club Heads and Methods to Manufacture Golf Club Heads," filed Feb. 10, 2015. International Search Report and Written Opinion issued in connection with corresponding application No. PCT/US2015/016666, on May 14, 2015 (8 pages).
 U.S. Appl. No. 14/498,603, Parsons et al., "Golf Club Heads and Methods to Manufacture Golf Club Heads," filed Sep. 26, 2014.
 U.S. Appl. No. 29/506,825, Nicolette, "Golf Club Head," filed Oct. 21, 2014.
 U.S. Appl. No. 14/589,277, Parsons et al., "Golf Club Heads and Methods to Manufacture Golf Club Heads," filed Jan. 5, 2015.
 U.S. Appl. No. 29/512,313, Nicolette, "Golf Club Head," filed Dec. 18, 2014.
 U.S. Appl. No. 29/514,256, Nicolette et al., "Golf Club Head," filed Jan. 9, 2015.
 U.S. Appl. No. 29/515,013, Nicolette et al., "Golf Club Head," filed Jan. 20, 2015.
 Kozuchowski, Zak, "Callaway Mack Daddy 2 PM Grind Wedges" (<http://www.golfwrx.com/276203/callaway-mack-daddy-2-pm-grind-wedges/>), www.golfwrx.com, GolfWRX Holdings, LLC, published Jan. 21, 2015.
 Wall, Jonathan, "Details: Phil's Prototype Mack Daddy PM-Grind Wedge," (<http://www.pgatour.com/equipmentreport/2015/01/21/callaway-wedge.html>), www.pgatour.com, PGA Tour, Inc., published Jan. 21, 2015.

* cited by examiner

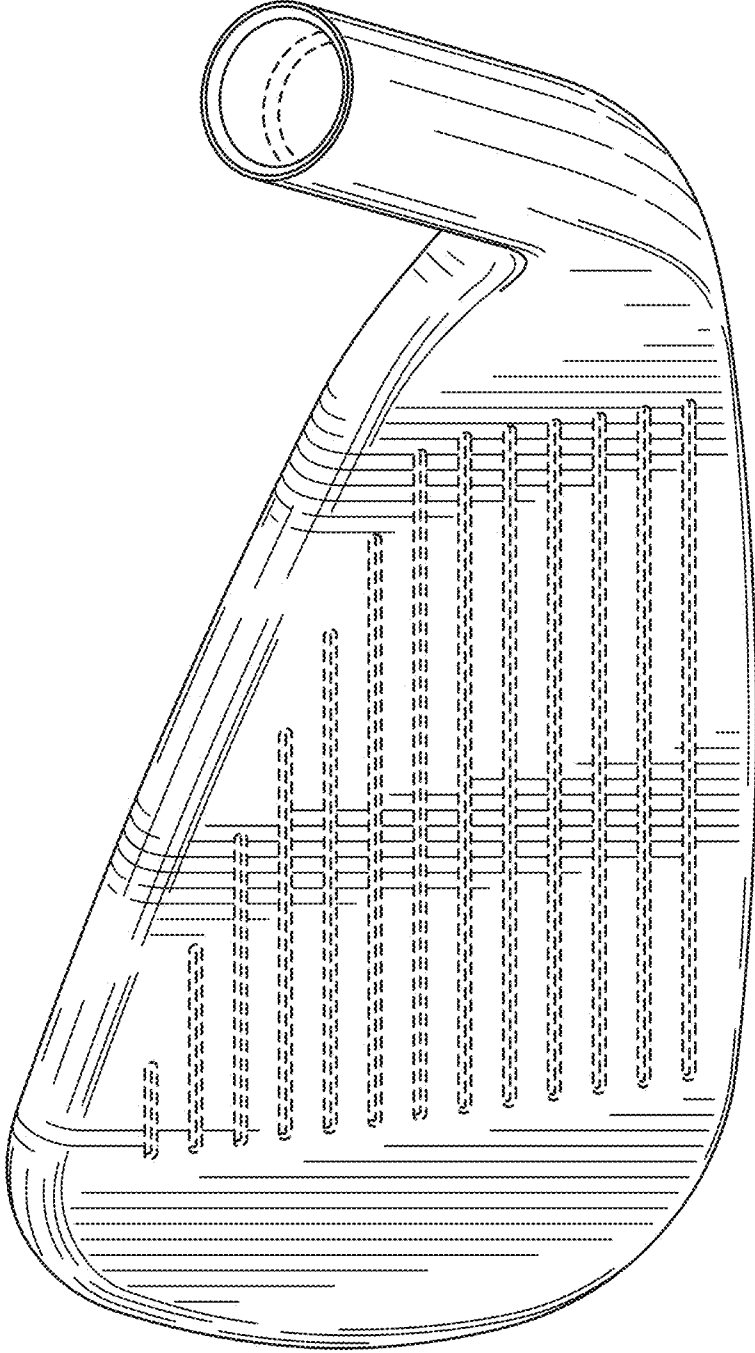

FIG. 1

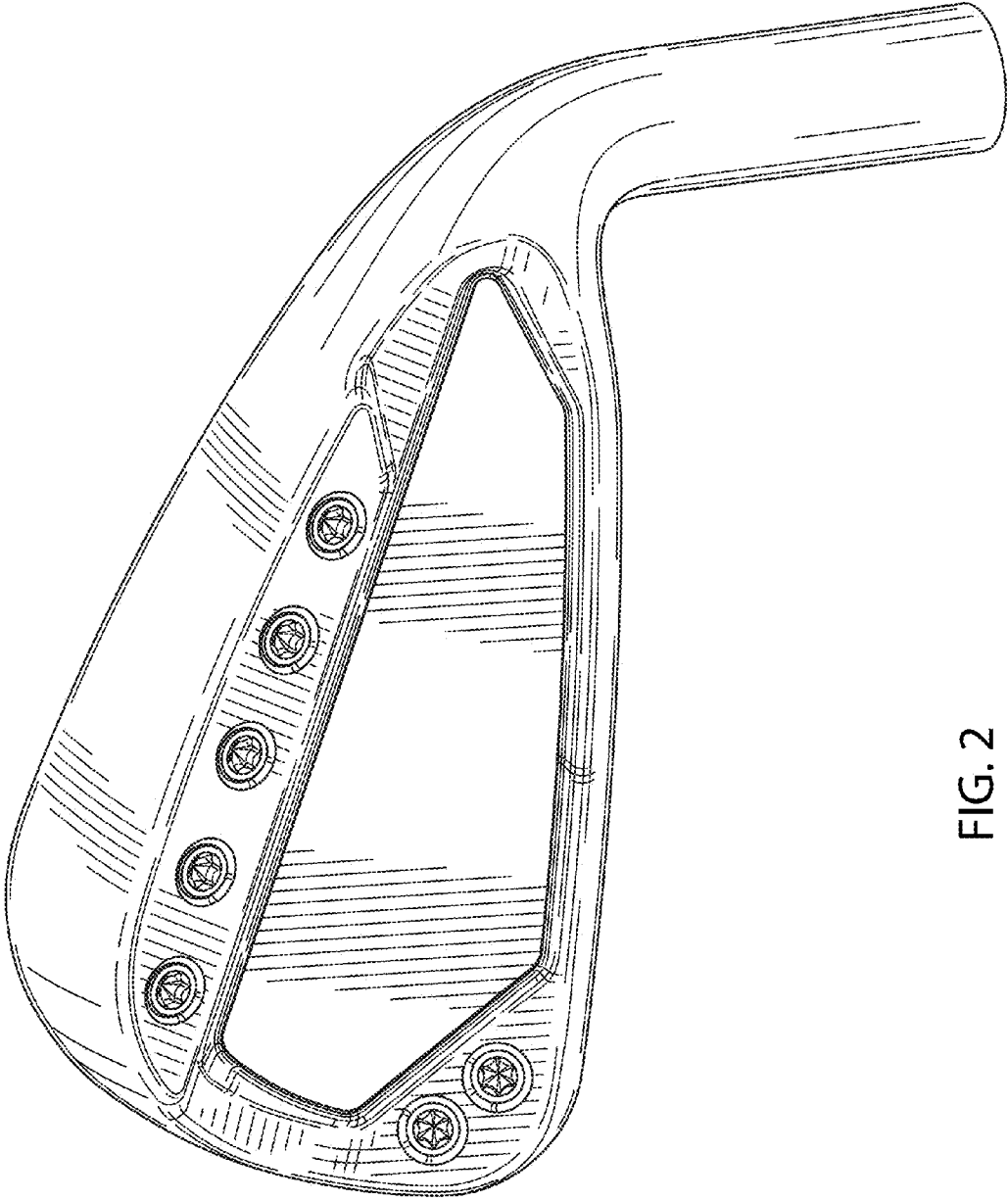

FIG. 2

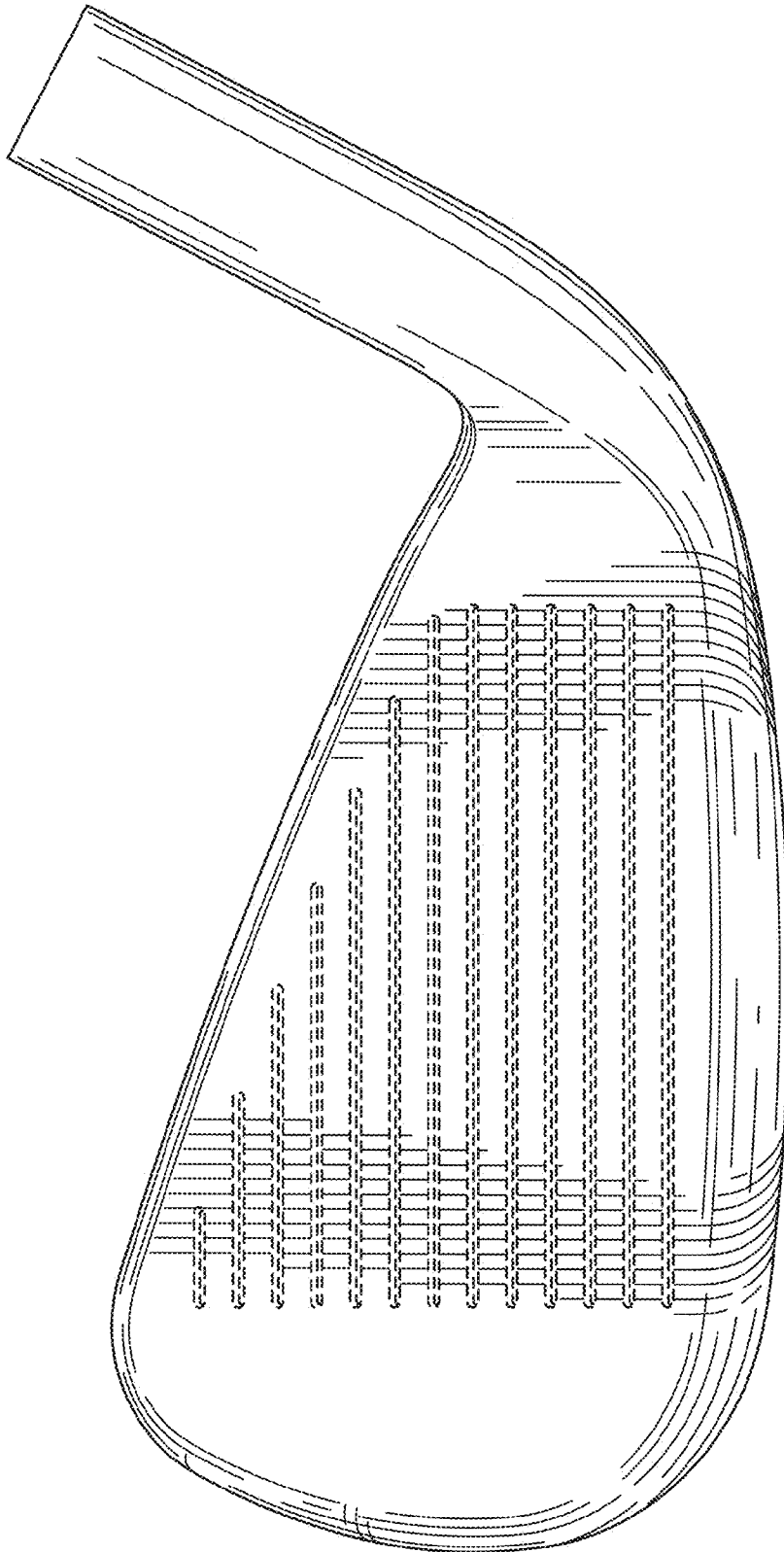

FIG. 3

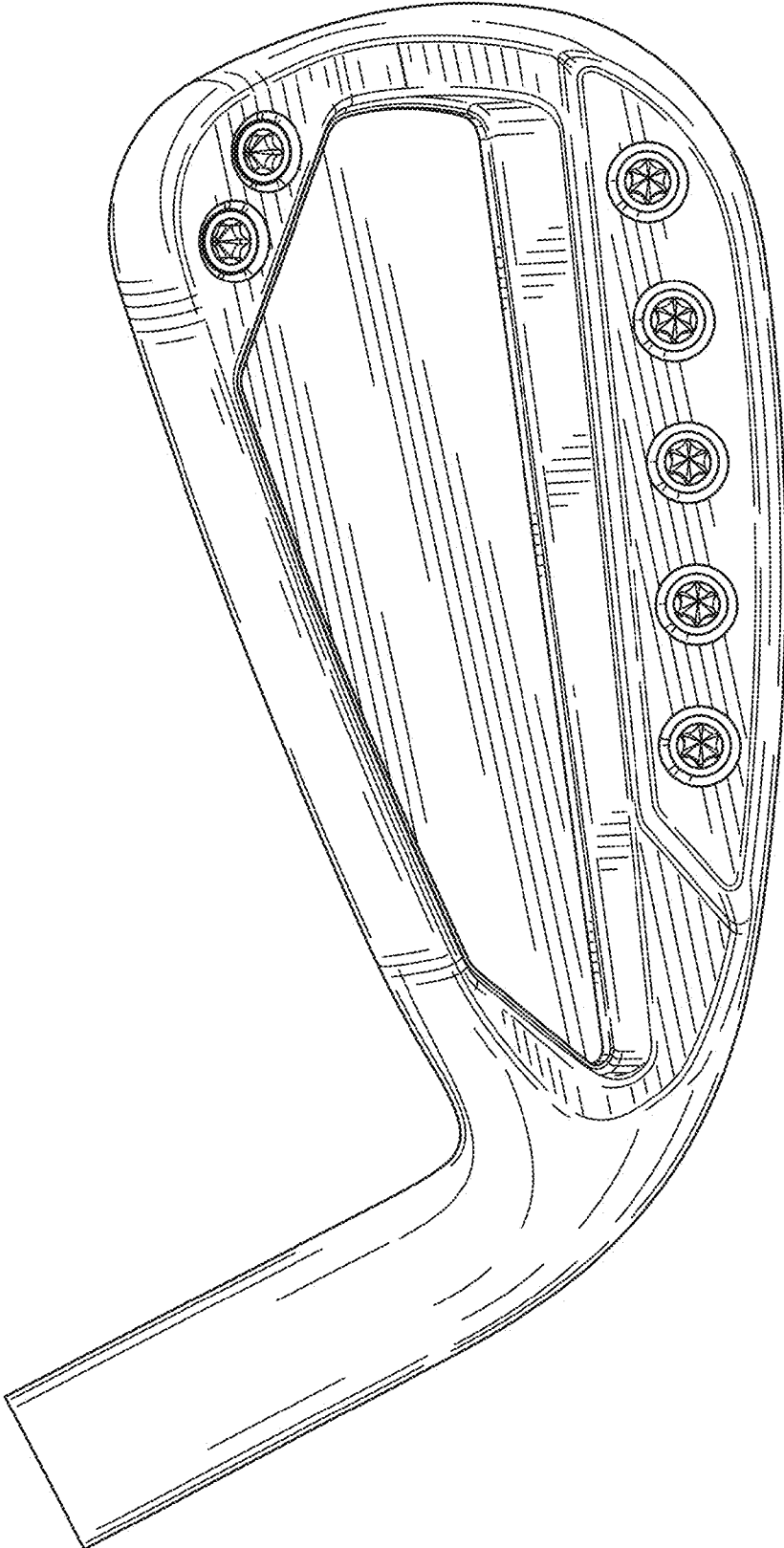

FIG. 4

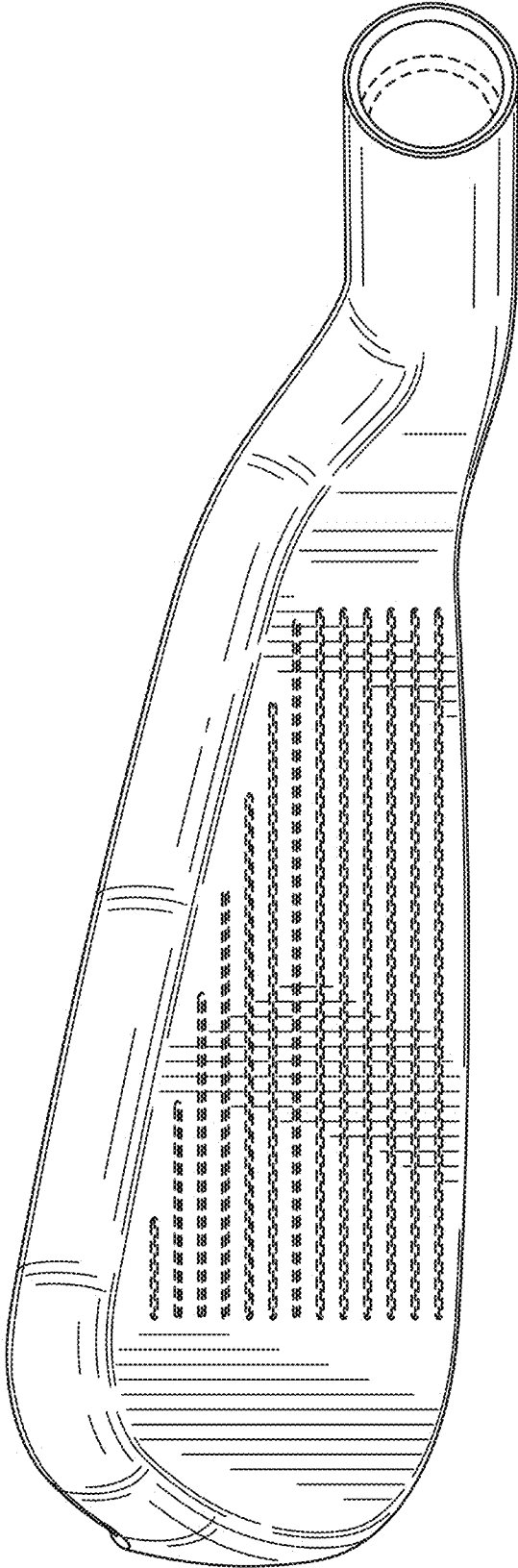

FIG. 5

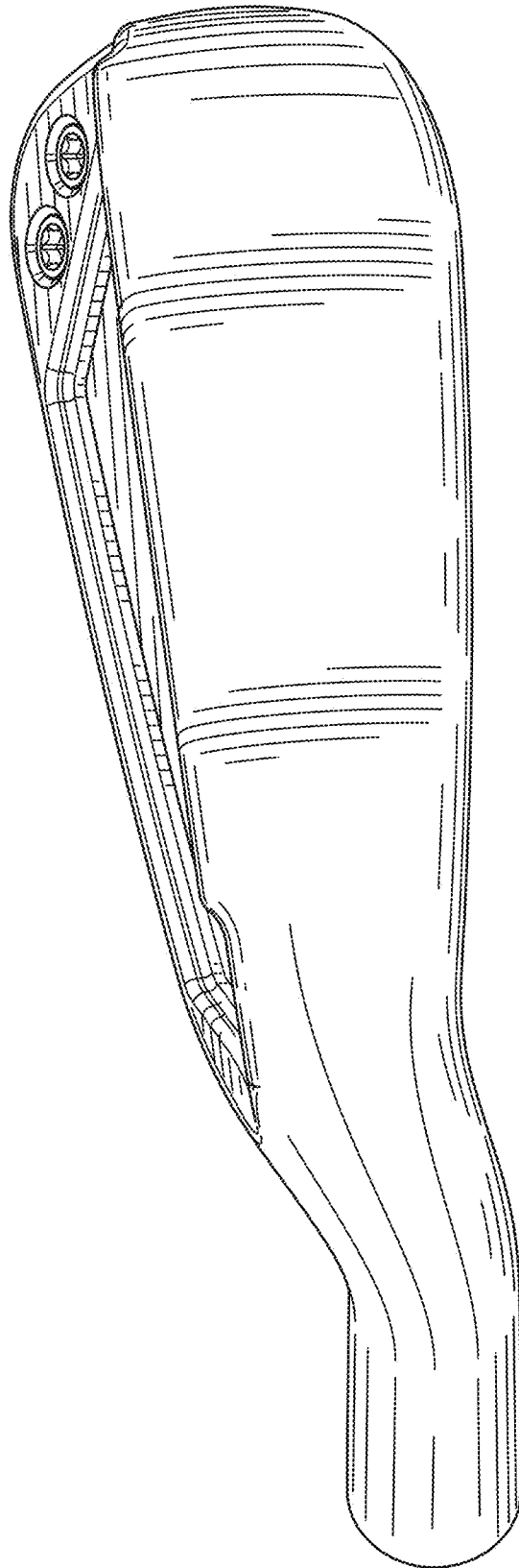

FIG. 6

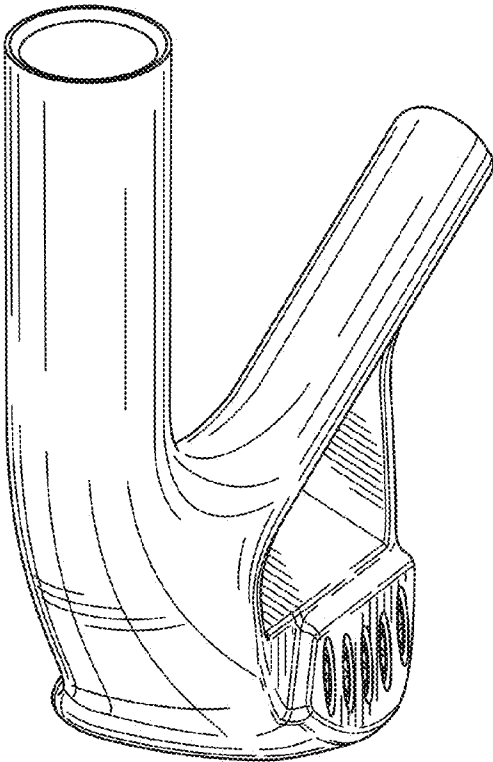

FIG. 7

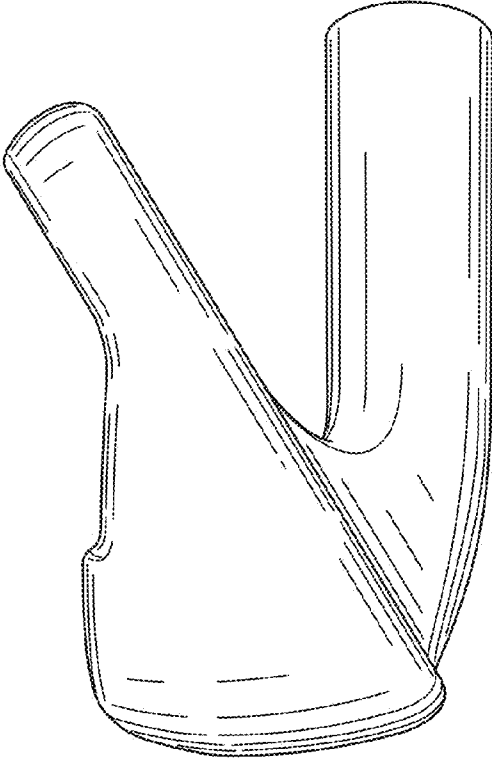

FIG. 8

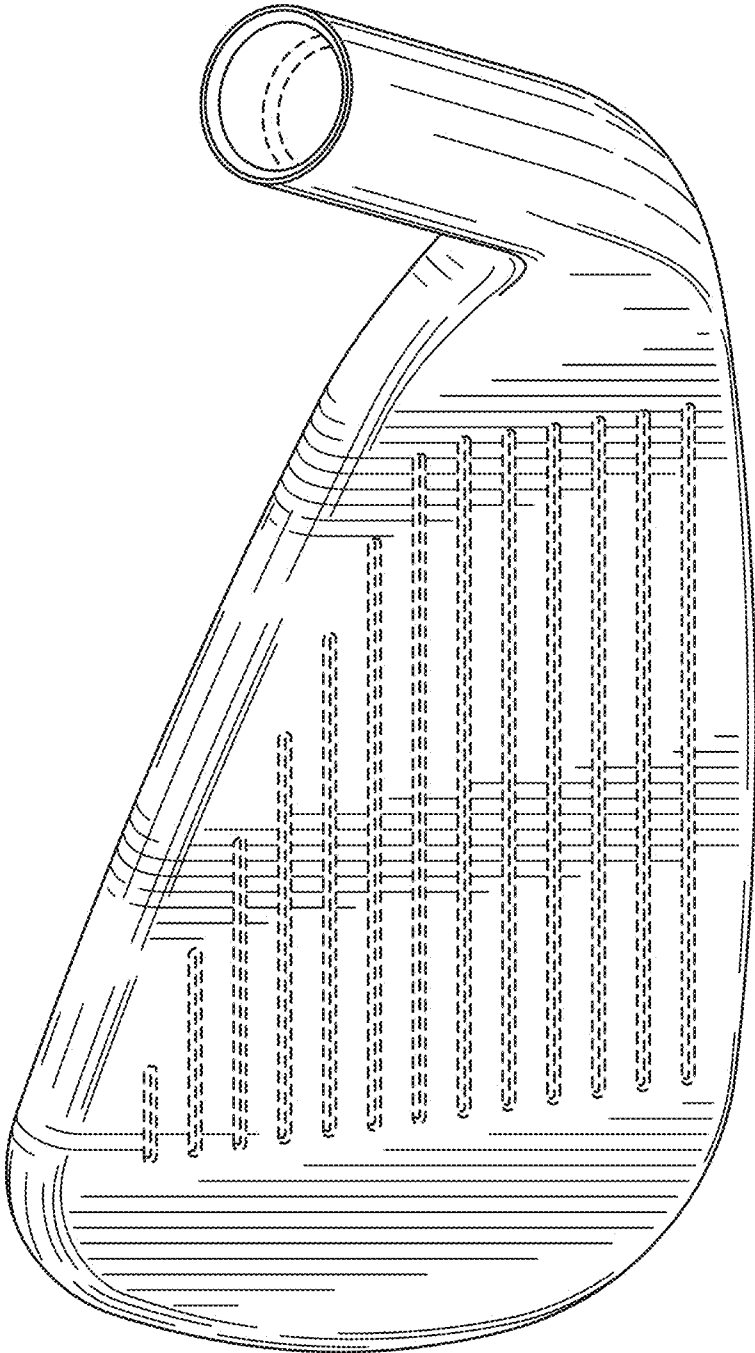

FIG. 9

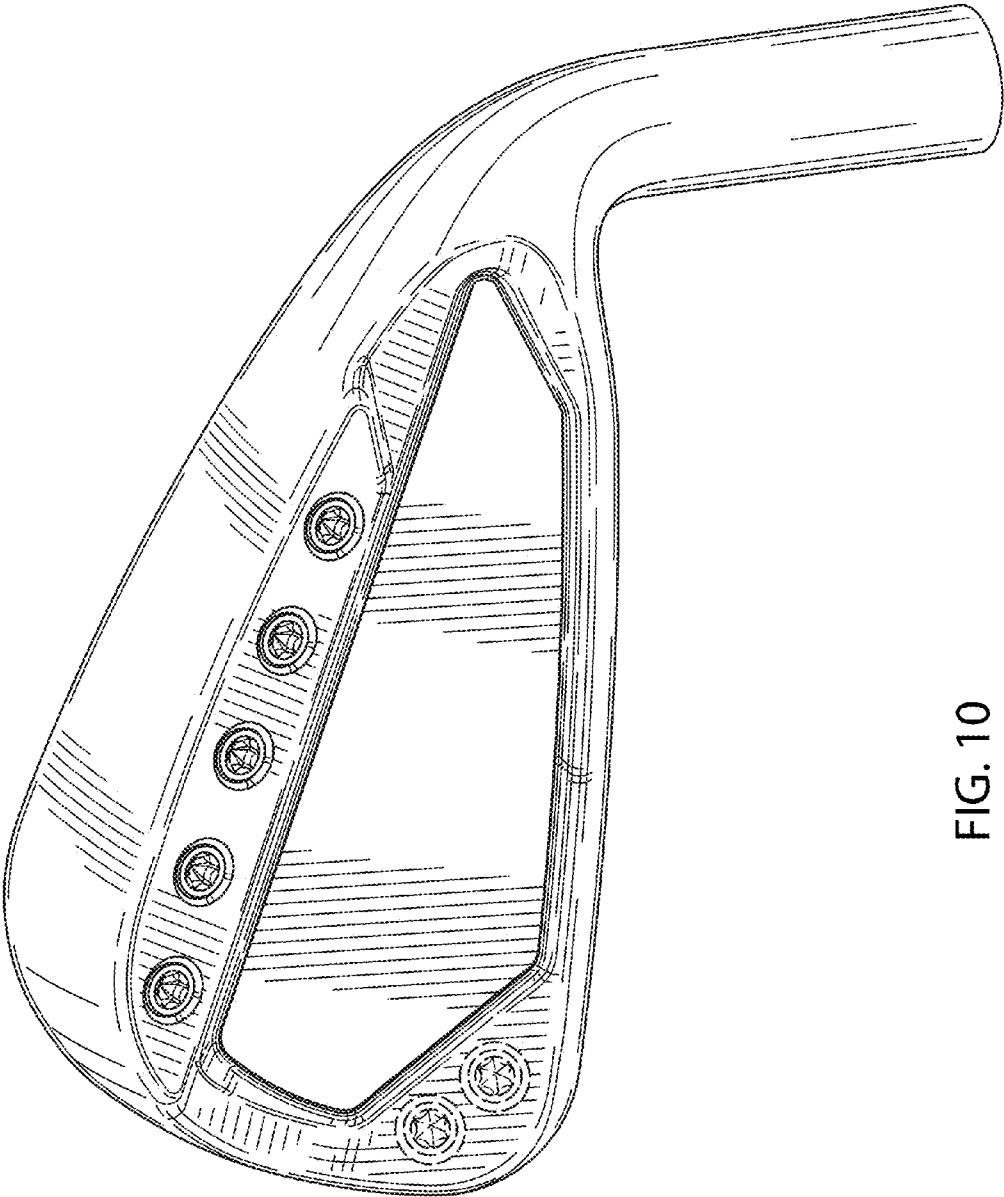

FIG. 10

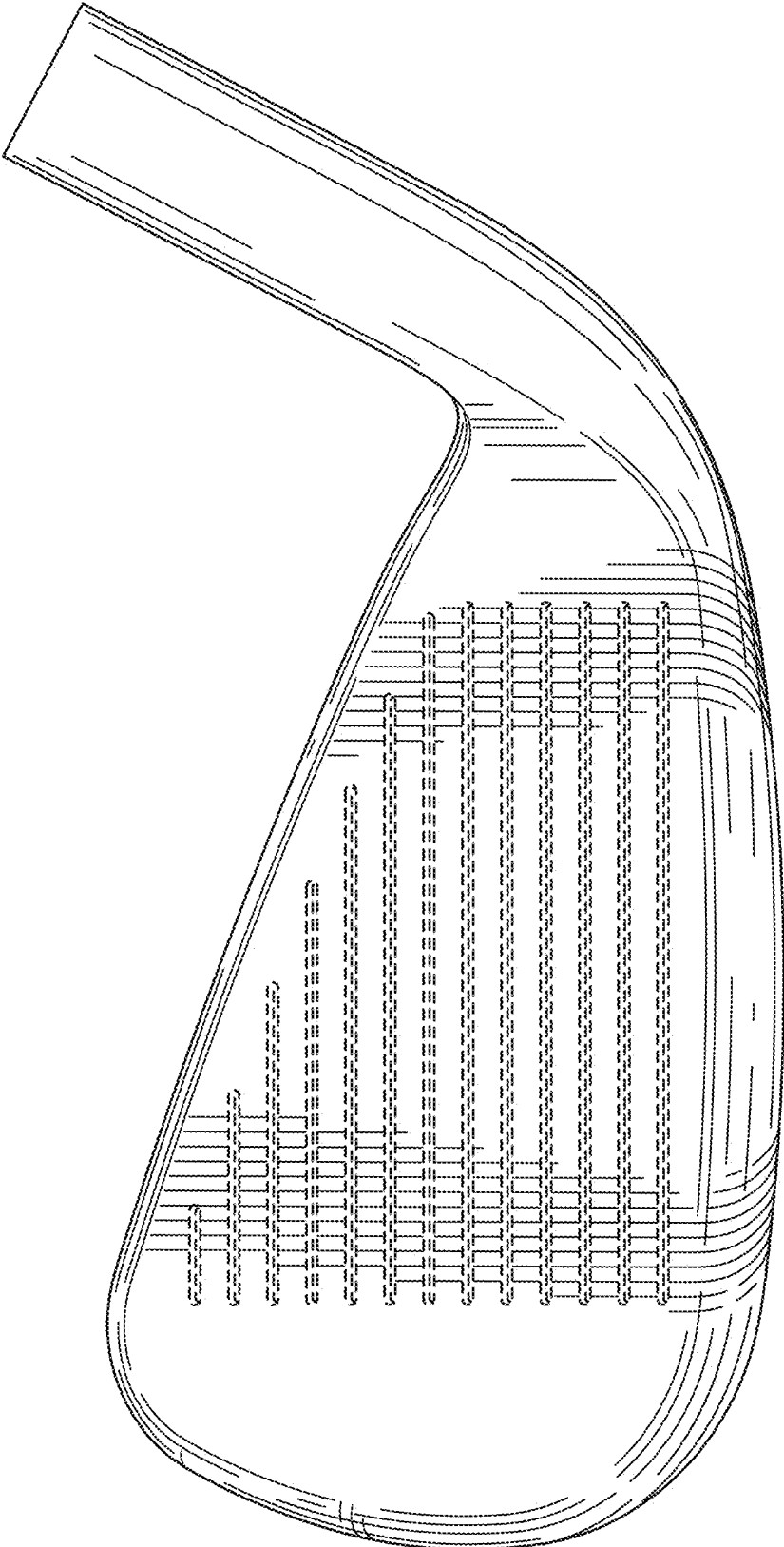

FIG. 11

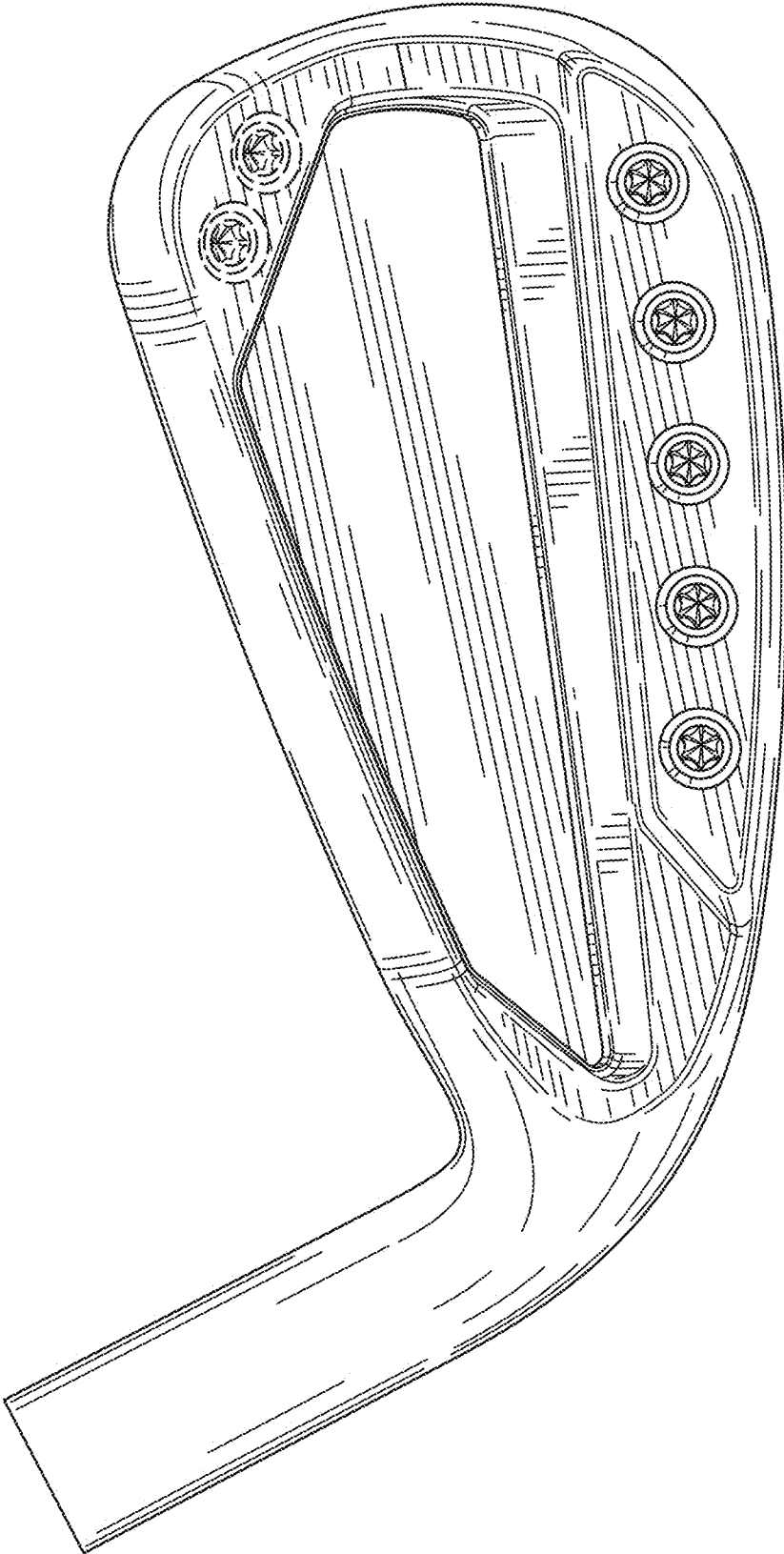

FIG. 12

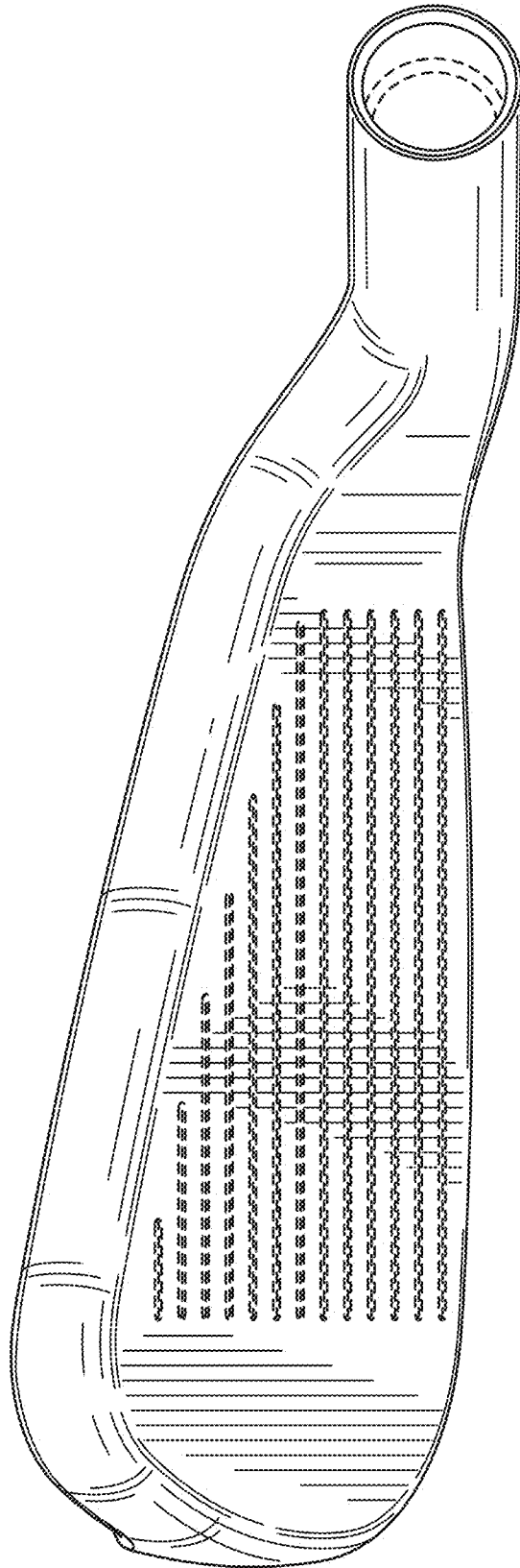

FIG. 13

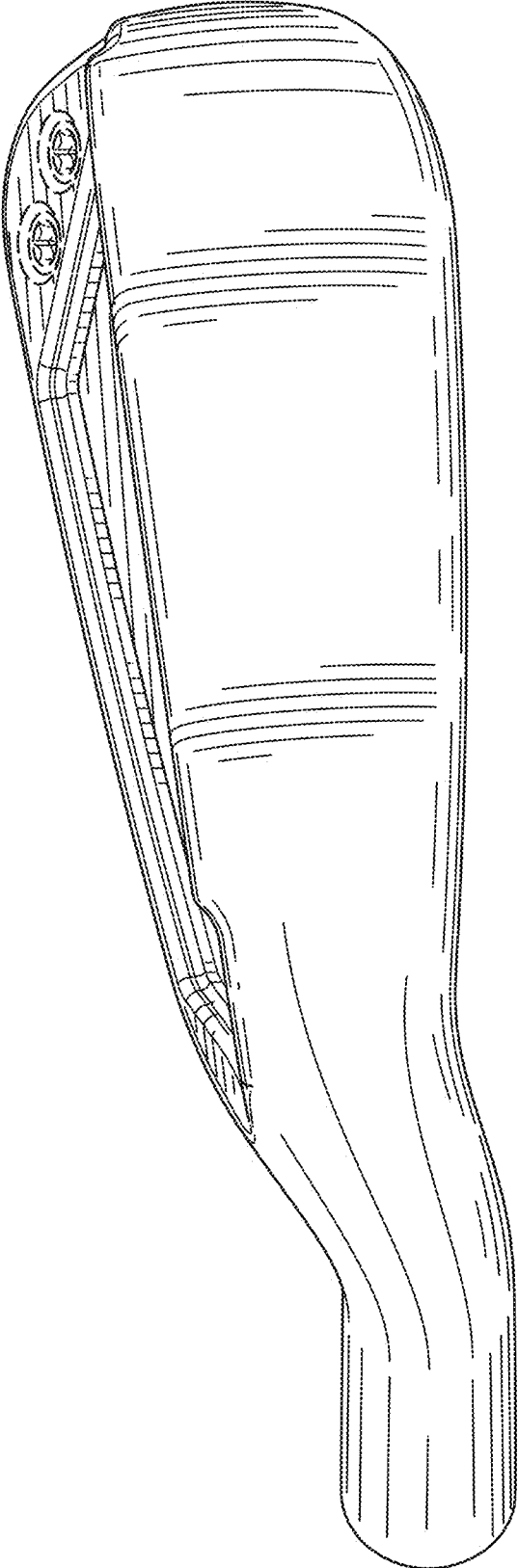

FIG. 14

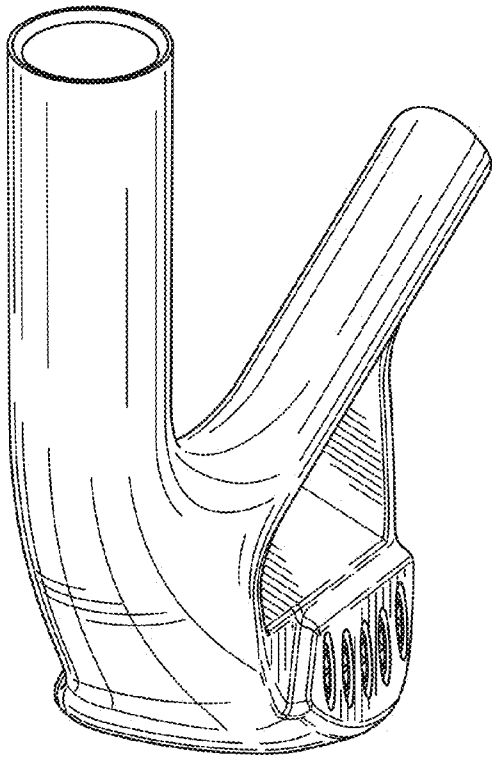

FIG. 15

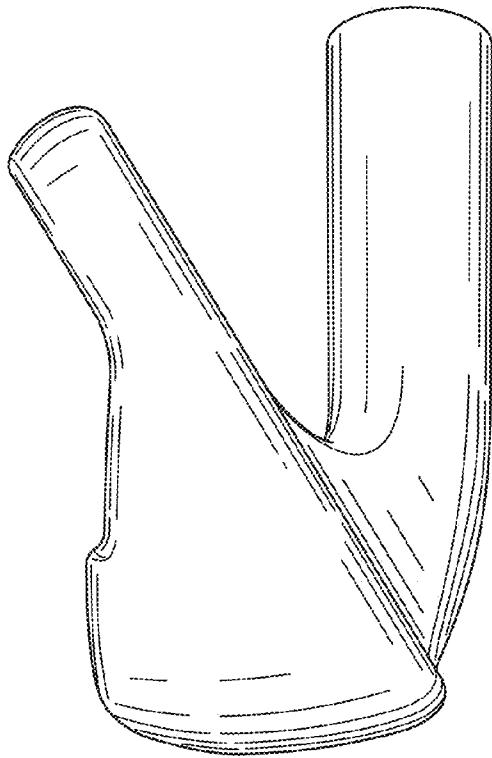

FIG. 16

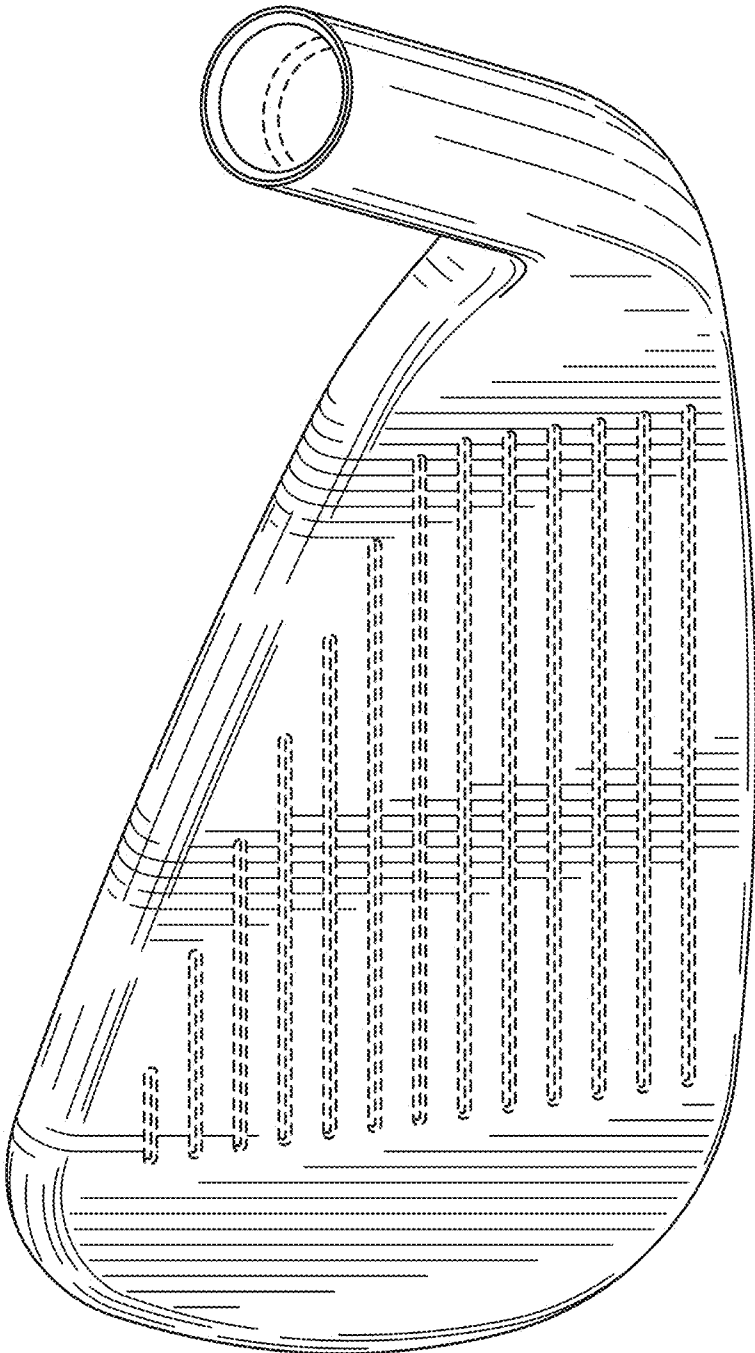

FIG. 17

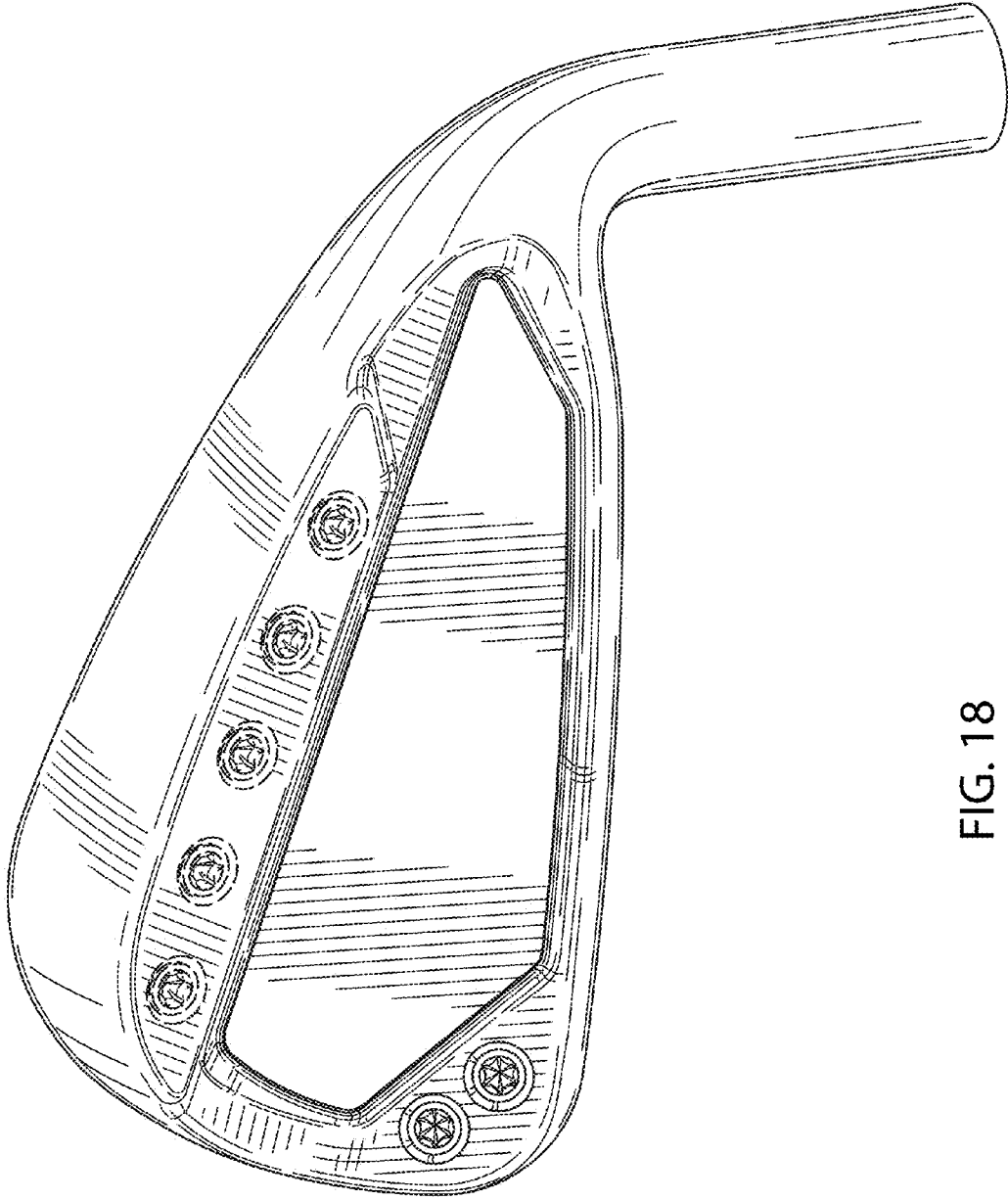

FIG. 18

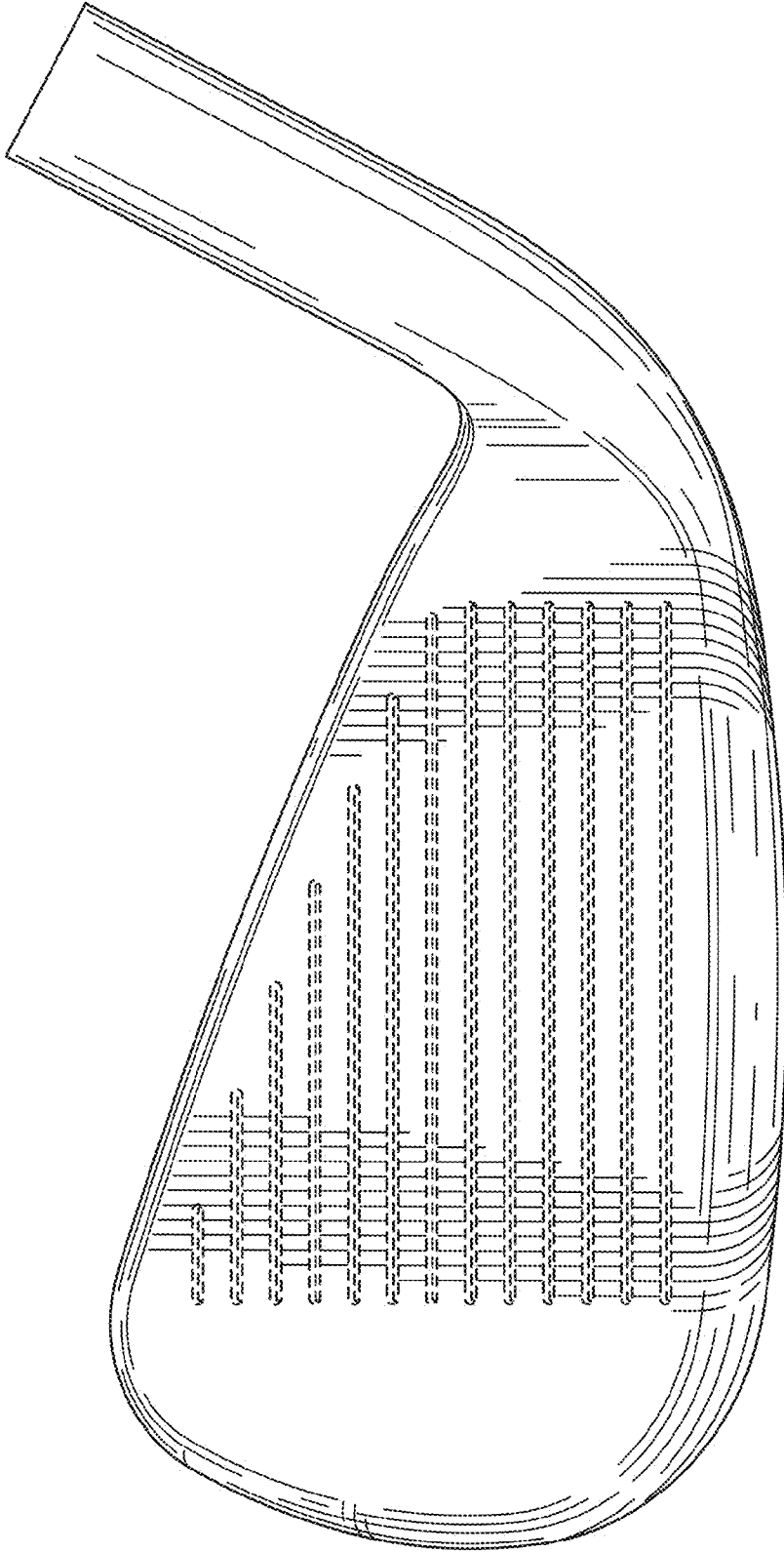

FIG. 19

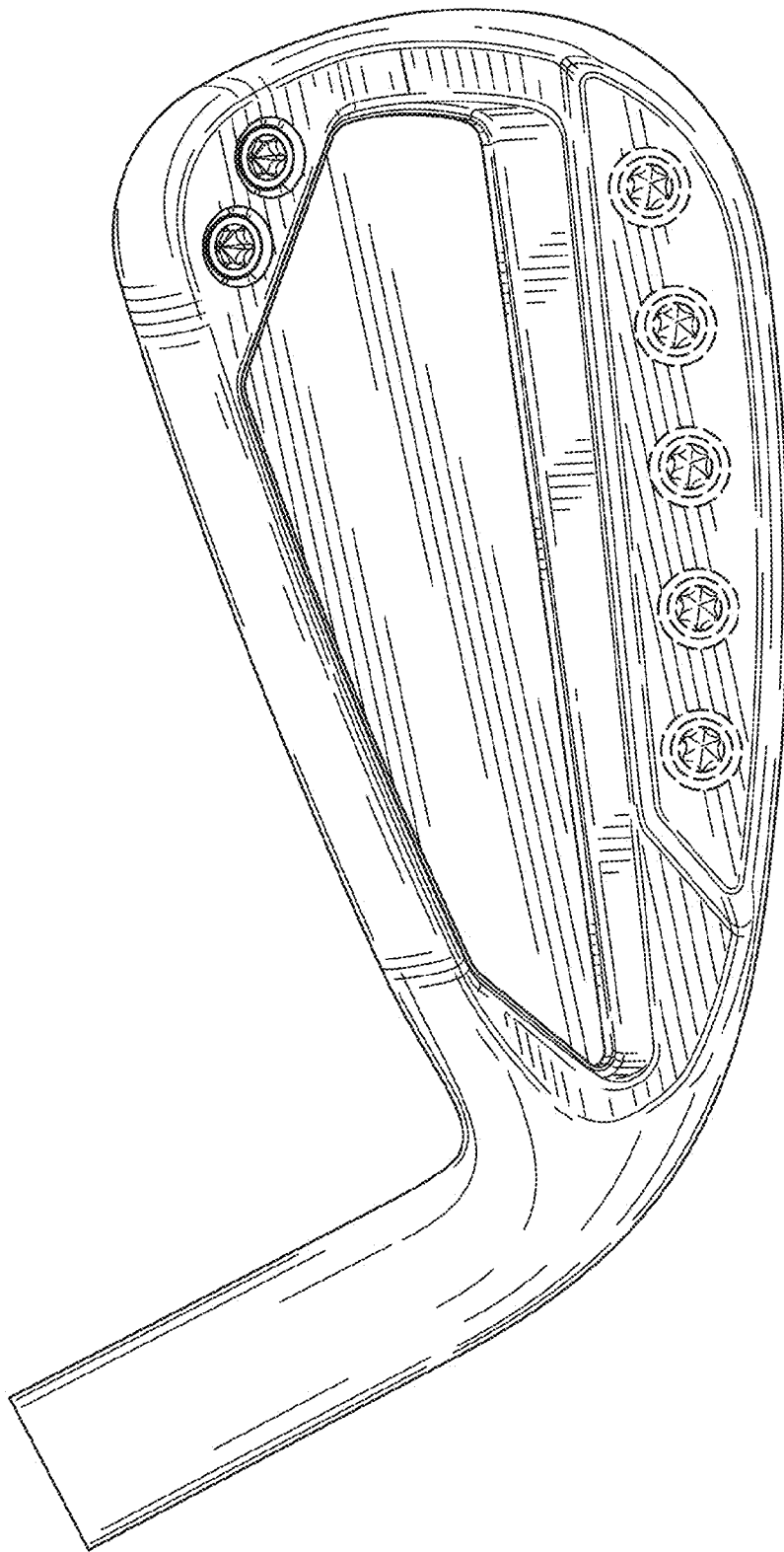

FIG. 20

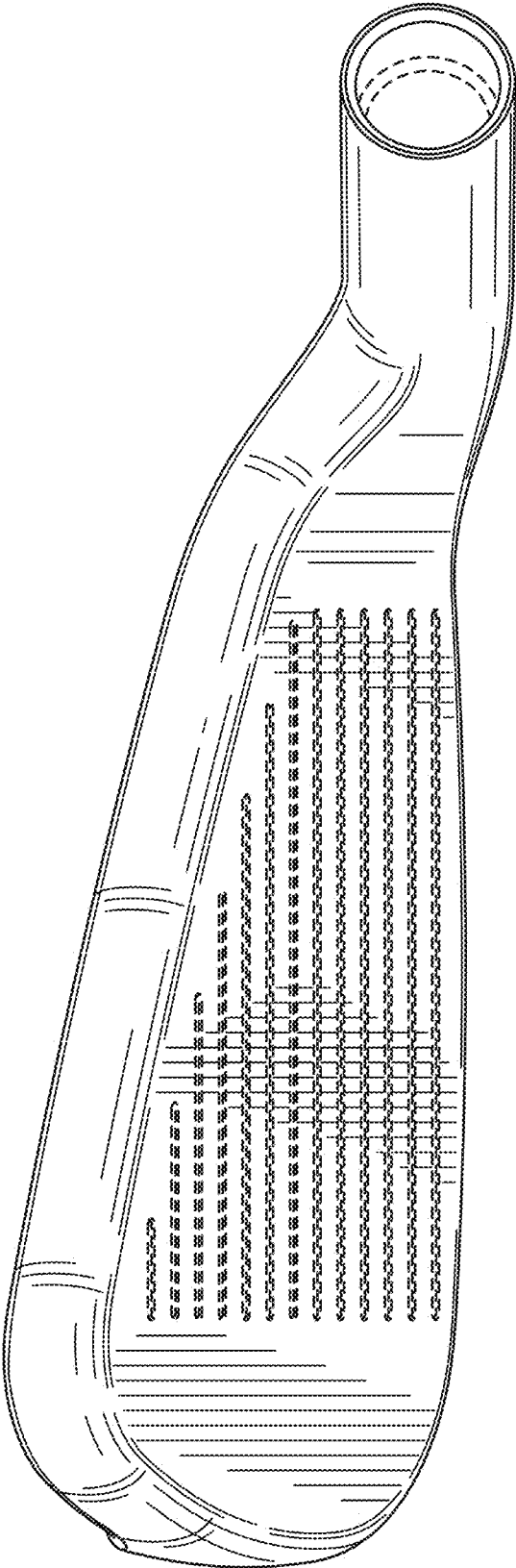

FIG. 21

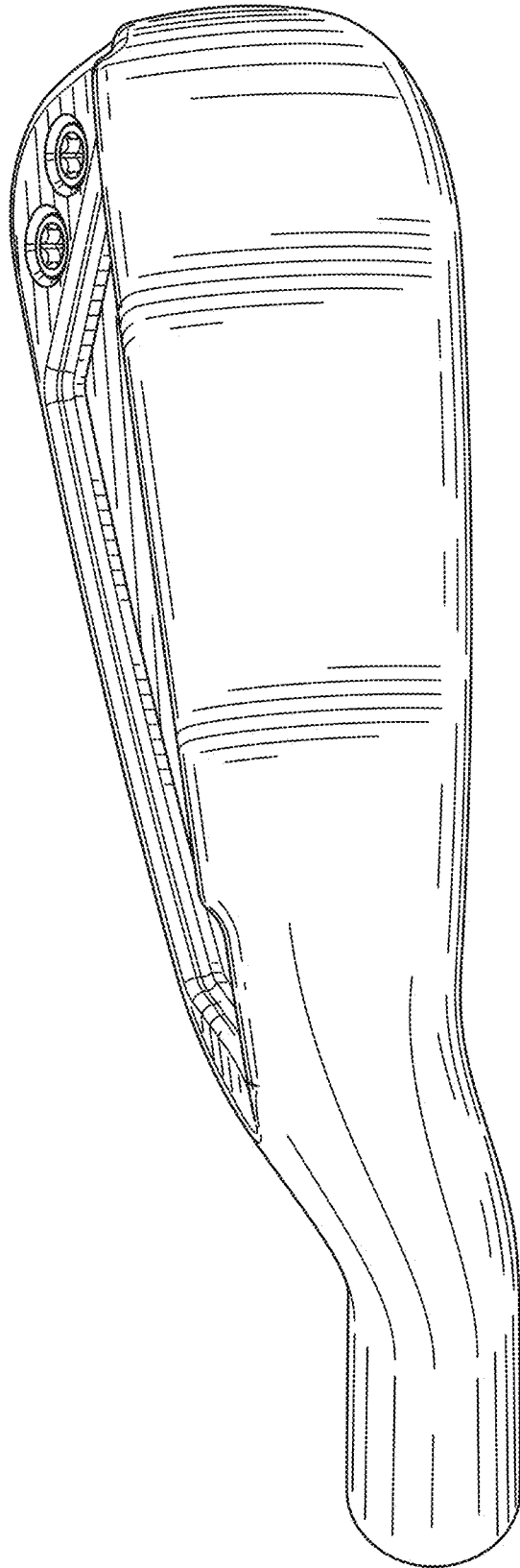

FIG. 22

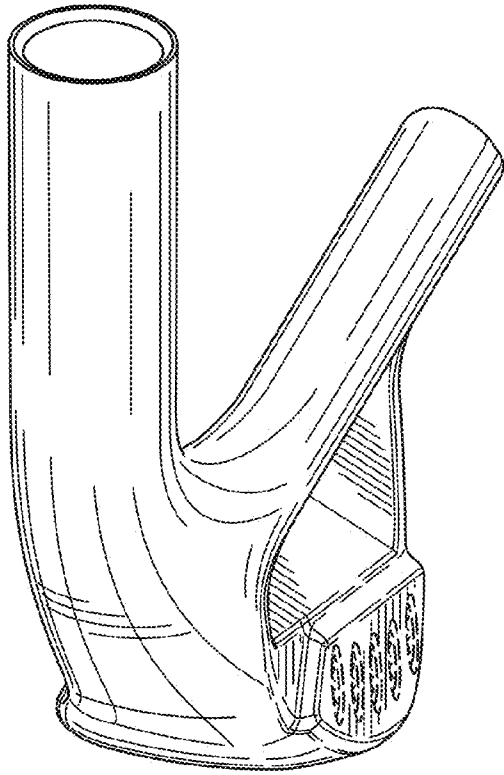

FIG. 23



FIG. 24