



US00D896103S

(12) **United States Design Patent**  
**Lee**

(10) **Patent No.:** **US D896,103 S**

(45) **Date of Patent:** **\*\* Sep. 15, 2020**

(54) **COSMETIC CONTAINER**  
(71) Applicant: **PUM-TECH KOREA CO., LTD,**  
Incheon (KR)  
(72) Inventor: **Do Hoon Lee,** Incheon (KR)

D726,552 S \* 4/2015 Awdeh ..... D9/724  
D726,553 S \* 4/2015 Koptis ..... D9/724  
D732,400 S \* 6/2015 Hua ..... D9/724  
D742,019 S \* 10/2015 Montgomery ..... D24/197  
D778,174 S \* 2/2017 Zhang ..... D9/724  
2003/0183596 A1\* 10/2003 Lombardo ..... A61J 9/04  
215/11.5

(73) Assignee: **PUM-TECH KOREA CO., LTD,**  
Incheon (KR)

\* cited by examiner

(\*\*) Term: **15 Years**

*Primary Examiner* — Janice Patyk

(21) Appl. No.: **29/681,767**

(74) *Attorney, Agent, or Firm* — Heedong Chae; Lucem,  
PC

(22) Filed: **Feb. 27, 2019**

(30) **Foreign Application Priority Data**

(57) **CLAIM**

Sep. 13, 2018 (KR) ..... 30-2018-0042999

The ornamental design for a cosmetic container, as shown  
and described.

(51) **LOC (12) Cl.** ..... **09-01**

(52) **U.S. Cl.**  
USPC ..... **D9/724**

(58) **Field of Classification Search**  
USPC ..... D9/442, 503, 695-699, 702-714,  
D9/723-729; D24/199; D28/7;  
132/317, 318, 320; 222/95, 207, 212,  
222/335

**DESCRIPTION**

CPC ..... A45D 34/00; A45D 40/00; B65D 81/3272  
See application file for complete search history.

FIG. 1 is a perspective view of the Cosmetic container  
showing my new design;  
FIG. 2 is a front elevational view thereof;  
FIG. 3 is a rear elevational view thereof;  
FIG. 4 is a left side view thereof;  
FIG. 5 is a right side view thereof;  
FIG. 6 is a top plan view thereof;  
FIG. 7 is a bottom plan view thereof; and,  
FIG. 8 is an exploded perspective view thereof.

(56) **References Cited**

**U.S. PATENT DOCUMENTS**

D675,485 S \* 2/2013 Frank ..... D7/629  
D692,319 S \* 10/2013 Moreau ..... D9/724

**1 Claim, 7 Drawing Sheets**

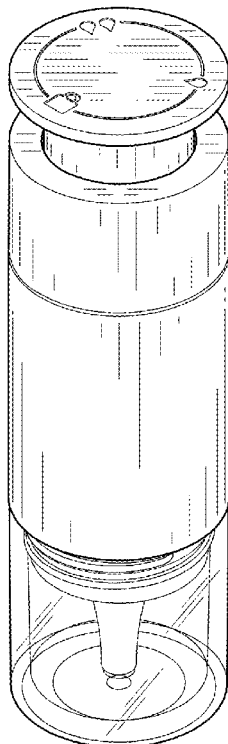

FIG. 1

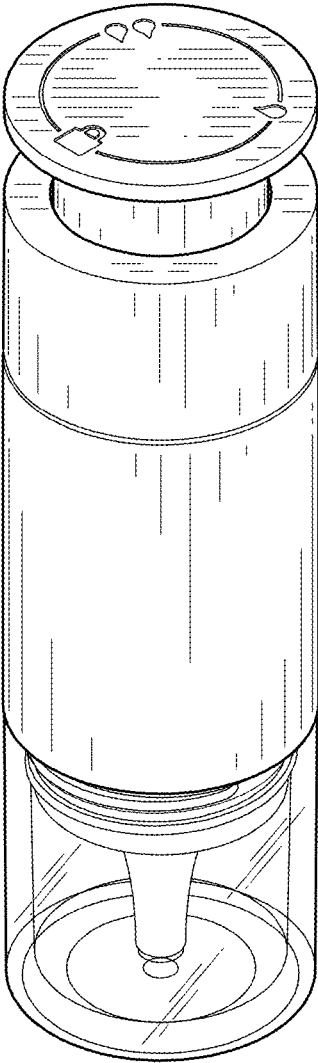

FIG. 2

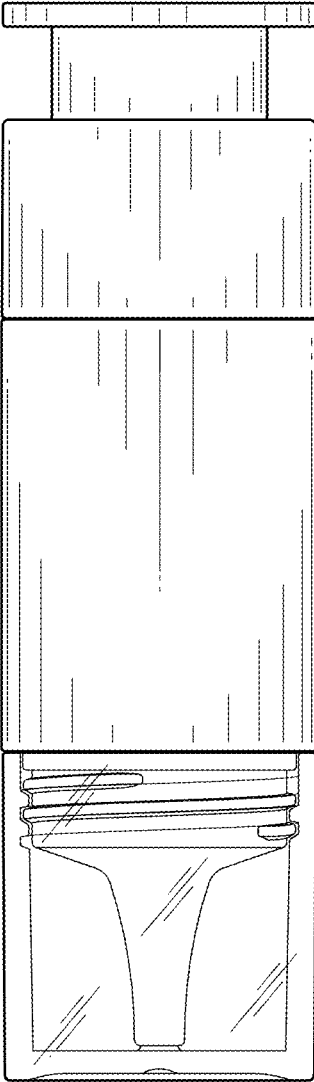

FIG. 3

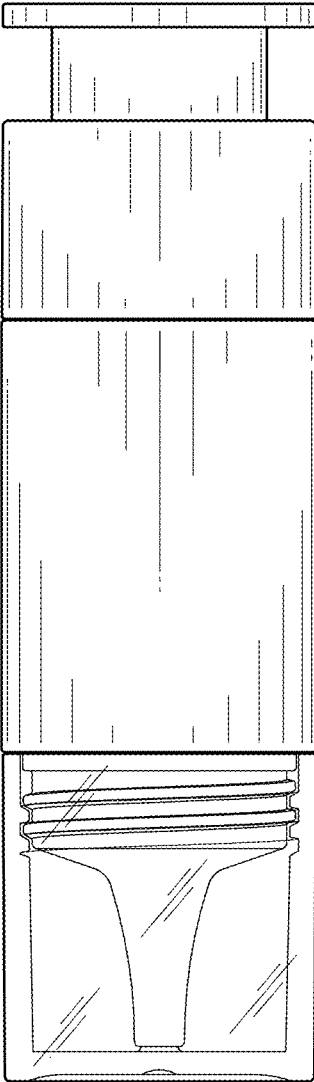

FIG. 4

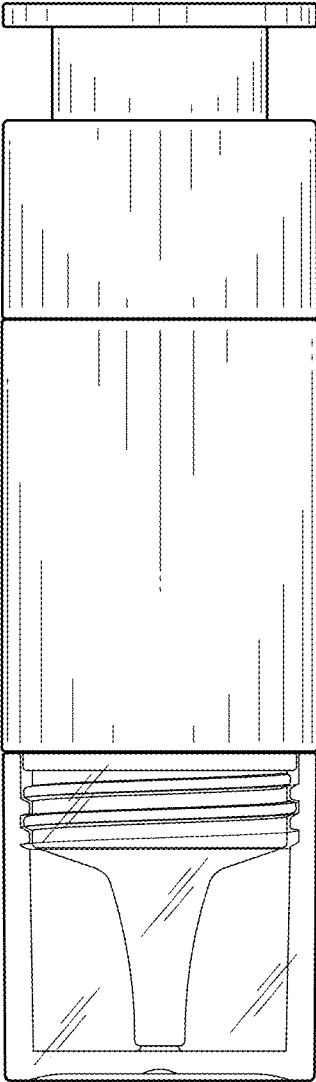

FIG. 5

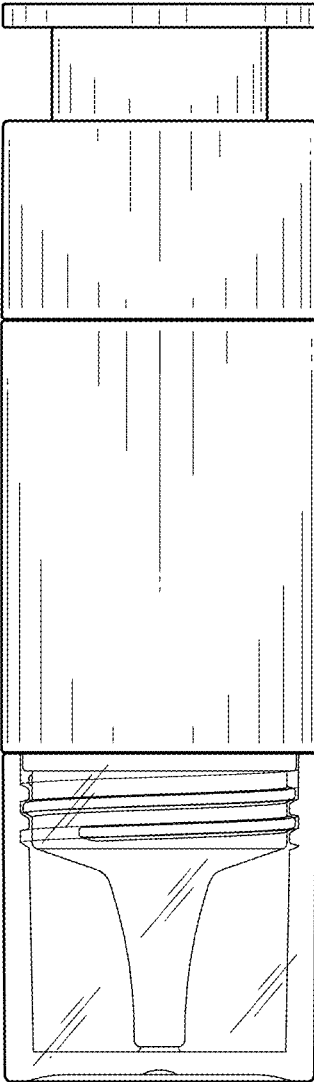

FIG. 6

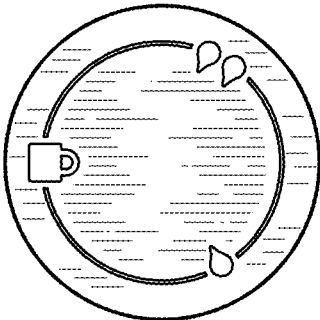

FIG. 7

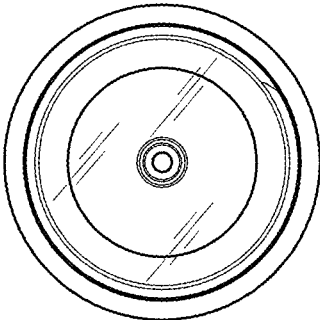

FIG. 8

