



(51) International Patent Classification:

A61B 18/00 (2006.01) A61B 18/14 (2006.01)
A61B 18/12 (2006.01)

(21) International Application Number:

PCT/US2014/023221

(22) International Filing Date:

11 March 2014 (11.03.2014)

(25) Filing Language:

English

(26) Publication Language:

English

(30) Priority Data:

61/788,012 15 March 2013 (15.03.2013) US
61/817,550 30 April 2013 (30.04.2013) US
61/817,561 30 April 2013 (30.04.2013) US

(71) Applicant: **ST. JUDE MEDICAL, CARDIOLOGY DIVISION, INC.** [US/US]; 177 East County Road B, St. Paul, Minnesota 55117 (US).

(72) Inventors: **BLIX, John B.**; 6583 Lanewood Lane North, Maple Grove, Minnesota 55311 (US). **BAKER, James C.**; 3448 Churchill Drive, Woodbury, Minnesota 55125 (US).

ENNETT, Kevin K.; 1466 Pheasant Hills Drive, Lino Lakes, Minnesota 55038 (US). **HEIN, John C.**; 2185 Willow Hill Drive, Neenah, Wisconsin 54956 (US). **BROTZ, Joseph A.**; 4321 Stoney Ridge Trail, Oshkosh, Wisconsin 54904 (US). **BARNIER, Joseph W.**; 213 Railroad Street, Menasha, Wisconsin 54952 (US). **FROELICH, Raymond V.**; 709 Chestnut Street, Neenah, Wisconsin 54956 (US). **VARADHARAJAN, Sukanya**; 1621 Woodlynn Avenue East, Unit 4, Maplewood, Minnesota 55109 (US). **OLSEN, Michael L.**; 13909 Utah Avenue, Savage, Minnesota 55376 (US).

(74) Agent: **MARKS, Scott**; St. Jude Medical, Cardiovascular and Ablation Technologies, 5050 Nathan Lane North, Plymouth, Minnesota 55442 (US).

(81) Designated States (unless otherwise indicated, for every kind of national protection available): AE, AG, AL, AM, AO, AT, AU, AZ, BA, BB, BG, BH, BN, BR, BW, BY, BZ, CA, CH, CL, CN, CO, CR, CU, CZ, DE, DK, DM, DO, DZ, EC, EE, EG, ES, FI, GB, GD, GE, GH, GM, GT, HN, HR, HU, ID, IL, IN, IR, IS, JP, KE, KG, KN, KP, KR, KZ, LA, LC, LK, LR, LS, LT, LU, LY, MA, MD, ME, MG, MK, MN, MW, MX, MY, MZ, NA, NG, NI, NO, NZ,

[Continued on next page]

(54) Title: MULTI-ELECTRODE ABLATION SYSTEM WITH A CONTROLLER FOR DETERMINING A THERMAL GAIN OF EACH ELECTRODE

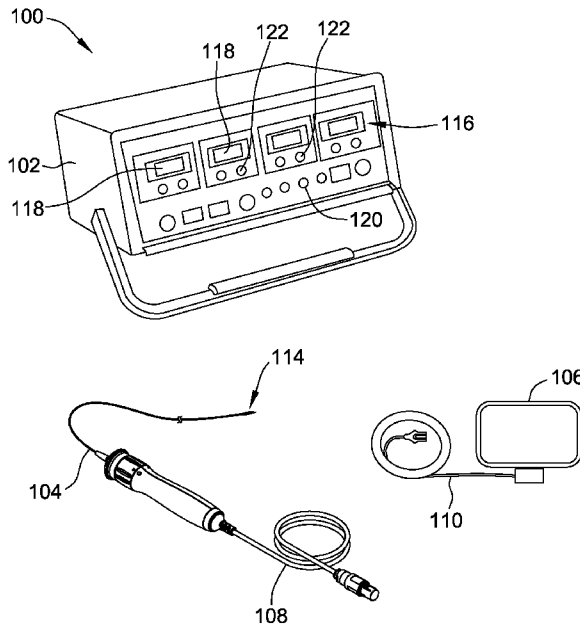
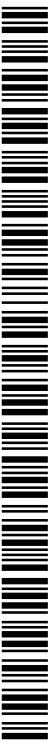

FIG. 1

(57) Abstract: A multi-electrode ablation system (100) is described that includes a power supply configured to be coupled to a plurality of electrodes and a controller coupled to the power supply. The controller is configured to determine a thermal gain of each electrode of the plurality of electrodes. For each electrode of the plurality of electrodes, the controller sets a power limit based at least in part on said electrode's determined thermal gain. The power limit establishes a maximum power that may be dissipated through said electrode.



OM, PA, PE, PG, PH, PL, PT, QA, RO, RS, RU, RW, SA, SC, SD, SE, SG, SK, SL, SM, ST, SV, SY, TH, TJ, TM, TN, TR, TT, TZ, UA, UG, US, UZ, VC, VN, ZA, ZM, ZW.

LV, MC, MK, MT, NL, NO, PL, PT, RO, RS, SE, SI, SK, SM, TR), OAPI (BF, BJ, CF, CG, CI, CM, GA, GN, GQ, GW, KM, ML, MR, NE, SN, TD, TG).

(84) Designated States (unless otherwise indicated, for every kind of regional protection available): ARIPO (BW, GH, GM, KE, LR, LS, MW, MZ, NA, RW, SD, SL, SZ, TZ, UG, ZM, ZW), Eurasian (AM, AZ, BY, KG, KZ, RU, TJ, TM), European (AL, AT, BE, BG, CH, CY, CZ, DE, DK, EE, ES, FI, FR, GB, GR, HR, HU, IE, IS, IT, LT, LU,

Published:

- with international search report (Art. 21(3))
- before the expiration of the time limit for amending the claims and to be republished in the event of receipt of amendments (Rule 48.2(h))

MULTI-ELECTRODE ABLATION SYSTEM WITH A CONTROLLER FOR DETERMINING A THERMAL GAIN OF EACH ELECTRODE

CROSS-REFERENCE TO RELATED APPLICATIONS

[0001] This application claims priority to provisional application serial No. 61/788,012, filed March 15, 2013, and to provisional application serial No. 61/817,550, filed April 30, 2013, and to provisional application serial No. 61/817,561, filed April 30, 2013, each of which is incorporated herein in its entirety.

BACKGROUND OF THE DISCLOSURE

a. Field of the Disclosure

[0002] The present disclosure relates generally to ablation systems, methods, and controllers. More particularly, the present disclosure relates to multi-electrode ablation systems, methods, and controllers.

b. Background Art

[0003] It is known that ablation systems are used to perform ablation procedures to treat certain conditions of a patient. A patient experiencing arrhythmia, for example, may benefit from ablation to prevent irregular heart beats caused by arrhythmogenic electric signals generated in cardiac tissues. By ablating or altering cardiac tissues that generate such unintended electrical signals, the irregular heart beats may be stopped. Ablation systems are also known for use in treating hypertension in patients. In particular, renal ablation systems, also referred to as renal denervation systems, are used to create lesions along the renal sympathetic nerves – a network of nerves that help control blood pressure. The intentional disruption of the nerve supply has been found to cause blood pressure to decrease.

[0004] Known techniques for renal denervation typically connect a radio frequency ("RF") generator to a catheter. The catheter is inserted in the renal artery and RF energy is emitted through an electrode in the distal end of the catheter

to heat the renal nerves to a temperature that reduces the activity of renal nerve(s) near the electrode. The electrode is repositioned to several locations around the inner circumference and the length of the artery during the process. Some renal denervation systems utilize a catheter with more than one electrode in order to reduce the number of times that the catheter must be repositioned during the denervation procedure. Some of these systems apply RF energy to the multiple electrodes sequentially, while others apply the RF energy to all of the electrodes simultaneously. In some systems that separately control the RF energy delivered to multiple electrodes, multiple power supplies are used to provide the RF energy to the electrodes.

[0005] Moreover, ablation is achieved by applying heat to the selected area(s) over time. Thus, it is important to regulate the amount of heat, and more particularly the temperature at each electrode, during treatment of the patient. Mechanical differences between electrodes, dissimilar contact qualities between the electrodes and the treatment area (e.g., the artery wall when using a renal denervation system), and other factors result in different power levels being required for each of the multiple electrodes to achieve a desired temperature set-point.

[0006] There is a need, therefore, for multi-electrode ablation systems that operate multiple electrodes simultaneously, efficiently, and accurately to regulate the temperature at the electrodes.

BRIEF SUMMARY OF THE DISCLOSURE

[0007] In one aspect, a multi-electrode ablation system includes a power supply configured to be coupled to a plurality of electrodes and a controller coupled to the power supply. The controller is configured to determine a thermal gain of each electrode of the plurality of electrodes. For each electrode of the plurality of electrodes, the controller sets a power limit based at least in part on said electrode's determined thermal gain. The power limit establishes a maximum power that may be dissipated through said electrode.

[0008] In another aspect, a method of operating a multi-electrode ablation system includes determining a thermal gain of each electrode of a plurality of

electrodes, and for each electrode of the plurality of electrodes, setting a power limit based at least in part on said electrode's determined thermal gain. The power limit establishes a maximum power that may be dissipated through said electrode.

[0009] In another aspect, a multi-electrode ablation system includes a power supply configured to be coupled to a plurality of electrodes and a controller coupled to the power supply. The controller is configured to set a power limit for each electrode of the plurality of electrodes, determine a thermal gain of each electrode of the plurality of electrodes, and determine, for each electrode, whether or not to reduce the power limit for that electrode based at least in part on the determined thermal gain of that electrode. The power limit establishes a maximum power that may be dissipated through the electrode.

[0010] In one aspect, a method of operating a multi-electrode ablation system includes setting a power limit for each electrode of a plurality of electrodes, determining a thermal gain of each electrode of the plurality of electrodes, and determining, for each electrode, whether or not to reduce the power limit for that electrode based at least in part on the determined thermal gain of that electrode. The power limit establishes a maximum power that may be dissipated through an electrode.

[0011] The foregoing and other aspects, features, details, utilities and advantages of the present disclosure will be apparent from reading the following description and claims, and from reviewing the accompanying drawings.

BRIEF DESCRIPTION OF THE DRAWINGS

[0012] Figure 1 is an isometric view of one embodiment of an ablation system including a generator, a catheter, and a return electrode.

[0013] Figure 2 is a partial view of a distal end of the catheter shown in Figure 1.

[0014] Figure 3 is a schematic block diagram of a controller for use in the generator shown in Figure 1.

[0015] Figure 4 is a functional block diagram of the ablation system shown in Figure 1.

[0016] Figure 5 is a digital signal processor (DSP) for use in the ablation system shown in Figure 1.

[0017] Figure 6 is a diagram of the operating states of the system shown in Figure 1.

[0018] Figure 7 is a diagram of a control cycle for use with the system shown in Figure 1.

[0019] Figure 8 is an equivalent circuit diagram of the system shown in Figure 1 when in use within an artery.

[0020] Figure 9 is a diagram of an output cycle of the system shown in Figure 1 with four electrodes enabled.

[0021] Figure 10 is a diagram of an output cycle of the system shown in Figure 1 with three electrodes enabled.

[0022] Figure 11 is a graphical representation of an output cycle of the system shown in Figure 1.

[0023] Figure 12 is a timing diagram of electrode switching signals in the system shown in Figure 1.

[0024] Figure 13 is a graphical representation of an output signal waveform from the generator shown in Figure 1.

[0025] Figure 14 is a graphical presentation of samples taken from the output signal waveform shown in Figure 13 graphed as a function of the output signal phase.

[0026] Figure 15A is a graph of a temperature set-point and an electrode temperature during a computer simulated ablation.

[0027] Figure 15B is a graph of the power applied to the electrode during the simulated ablation shown in Figure 15A.

[0028] Figure 15C is a graph of the thermal gain of the electrode during the simulated ablation shown in Figure 15A

[0029] Figure 16A is a graph of a temperature set-point and an electrode temperature during a computer simulated ablation.

[0030] Figure 16B is a graph of the power applied to the electrode and a power limit during the simulated ablation shown in Figure 16A.

[0031] Figure 16C is a graph of the actual thermal gain of the electrode and the calculated thermal gain of the electrode during the simulated ablation shown in Figure 16A.

[0032] Figure 17 is a graph of electrode temperature, temperature set-point, and power delivered to the electrode during a bench simulated ablation.

[0033] Figure 18 is a graph of electrode temperature, thermal gain, power limit, power delivered to the electrode, and energy dissipated through the electrode during an animal ablation test.

[0034] Figure 19 is a graph of electrode temperature, thermal gain, power limit, power delivered to the electrode, and energy dissipated through the electrode during another animal ablation test.

[0035] Figure 20 is a graph of electrode temperature, thermal gain, power limit, power delivered to the electrode, and energy dissipated through the electrode during an animal ablation test.

[0036] Figure 21 is graph of an electrode temperature during a simulated ablation.

[0037] Figure 22 is graph of electrode temperature for four electrodes during a simulated ablation.

[0038] Figure 23 is graph of electrode temperature with a two stage ramp during a simulated ablation.

[0039] Figure 24 is a flow diagram of an implementation of adaptive power limiting in an ablation system.

[0040] Corresponding reference characters indicate corresponding parts throughout the drawings.

DETAILED DESCRIPTION OF THE DRAWINGS

[0041] This disclosure relates generally to ablation systems, methods, and controllers. More particularly, this disclosure relates to multi-electrode ablation systems, methods, and controllers. Still more particularly, this disclosure relates to multi-electrode renal ablation systems, methods, and controllers.

[0042] The methods and systems described herein provide accurate and efficient control of a multi-electrode ablation system. In general, various novel techniques for separately controlling when, how long, and how much energy to dissipate through each electrode in a multi-electrode system are described. For example, one exemplary system provides time-multiplexed simultaneous delivery of ablation power to multiple ablation electrodes with a single power supply. The energy required to meet the energy demand of each electrode is calculated and a duty cycle for each electrode is set accordingly. The output voltage of the single power supply is selected to provide sufficient power for the electrode with the highest energy demand. A common return path resistance is determined using a single current sensor in the return path of a multi-electrode ablation system and used to control one or more aspects of operation of the system.

[0043] Referring now to the drawings and in particular to Figures 1-4, an ablation system, generally indicated at 100, includes an ablation generator 102, a multi-electrode ablation catheter 104, and a return electrode 106. The ablation catheter 104 is removeably coupled to the ablation generator 102 by a cable 108. The return electrode 106 is removeably coupled to the ablation generator 102 by a cable

110. In use, the return electrode 106 is placed externally against a patient's body and the catheter 104 is inserted into the patient's body. Generally, the ablation generator 102 outputs radio frequency (RF) energy to the catheter 104 through the cable 108. The RF energy leaves the catheter 104 through a plurality of electrodes 112 (shown in Figure 3) located at the distal end 114 of catheter 104. The RF energy travels through the patient's body to the return electrode 106. The dissipation of the RF energy in the body increases the temperature near the electrodes, thereby permitting ablation to occur. In the exemplary embodiment set forth herein, the ablation system 100 is a renal ablation system suitable for use in performing renal denervation. It is understood, however, that the ablation system may be used for other treatments without departing from the scope of this disclosure.

[0044] The generator 102 includes a user interface (UI) portion 116 for displaying information and notifications to an operator and receiving input from the user. Display devices 118 visually display information, such as measured temperatures, power output of the generator, temperature thresholds, cycle time, etc., and/or notifications to the user. Display devices 118 may include a vacuum fluorescent display (VFD), one or more light-emitting diodes (LEDs), liquid crystal displays (LCDs), cathode ray tubes (CRT), plasma displays, and/or any suitable visual output device capable of displaying graphical data and/or text to a user. The indicators 120 provide visual notifications and alerts to the user. In other embodiments, one or more of the indicators 120 provide audible notifications and/or alerts to the user. In the illustrated embodiment, indicators 120 are lights, such as light emitting diodes, incandescent lamps, etc. The indicators 120 may be turned on or off, for example, to indicate whether or not the generator 102 is receiving power, whether or not the catheter 104 is connected, whether or not the catheter (or all electrodes 112) are functioning properly, etc. Moreover, the indicators 120 may indicate a quality or degree of a feature or component of the system 100, such as by changing color, changing intensity, and/or changing the number of the indicators 120 that are turned on. Thus, for example, an indicator 120 may change color to represent a unitless notification of the quality of the contact between one or more of the electrodes 112 and an artery wall. UI portion 116 includes inputs 122, e.g., buttons,

keys, knobs, etc., for receiving commands and/or requests from a user. In some embodiments, the UI portion 116, additionally or alternatively, displays a graphical user interface to a user, such as via one or more of the display device 118.

[0045] As shown in Figure 2, the multiple electrodes 112 may be disposed on a basket 124 located at the distal end 114 of the catheter 104. In the illustrated embodiment, basket 124 is an expandable basket that may be expanded and collapsed by an operator of the system 100 to position electrodes 112 against, for example, an artery wall. In the illustrated embodiment, the catheter 104 includes four electrodes 112. In other embodiments, the catheter 104 may include at least two, but other than four, electrodes 112. A thermocouple (not shown, also referred to herein as a temperature sensor) is attached to each electrode 112 provides temperature readings of the electrode. The catheter 104 also contains a thermistor (not shown) and a 1-Wire EEPROM. The generator 102 uses the thermistor for measuring ambient temperature and performing cold-junction compensation on the thermocouples. The EEPROM contains a unique ID which allows the generator 102 to reject devices not manufactured specifically for use with the generator 102. The generator 102 also maintains usage data on the EEPROM in order to enforce maximum operation limits for the catheter 104.

[0046] Referring now to Figure 3, generator 102 includes a power supply 126, a controller 128, and an RF output circuit 130. Power supply 126 receives AC power via an input 132 and converts the received power to a DC power output. The DC power output is provided to the RF output circuit 130 that outputs RF power to the catheter 104, and more specifically to the electrodes 112, via output 134. In the exemplary embodiment, power supply 126 includes a buck converter to provide a DC output of a lesser magnitude than the magnitude of the rectified AC power input. The controller 128 is coupled to and controls operation of the power supply 126 and the RF output circuit 130. As will be described in more detail below, the controller 128 controls operation of power supply 126 to cause the power supply to generate a desired output voltage, i.e. a DC output voltage having a magnitude determined by the controller 128. In other embodiments, the power supply 126 includes its own controller configured to control operation of the power supply 126 to

generate the determined output voltage in response to a command from the controller 128. The controller 128 also controls operation of the RF output circuit 130. Controller 128 controls when and to which electrodes 112 the RF output circuit 130 couples its RF power output. In other embodiments, the RF output circuit 130 includes its own controller configured to control operation of the RF output circuit 130 in response to commands from the controller 128. In some embodiments, the RF output circuit 130 is part of, and integrated into, the power supply 126.

[0047] The controller 128 includes a processor 136 and a memory device 138 coupled to the processor 136. The term “processor” refers herein generally to any programmable system including systems and microcontrollers, reduced instruction set circuits (RISC), application specific integrated circuits (ASIC), programmable logic circuits, field programmable gate array (FPGA), gate array logic (GAL), programmable array logic (PAL), digital signal processor (DSP), and any other circuit or processor capable of executing the functions described herein. The above examples are exemplary only, and thus are not intended to limit in any way the definition and/or meaning of the term “processor.” Moreover, although a single processor is illustrated in Figure 3, the processor 136 may include more than one processor and the actions described herein may be shared by more than one processor.

[0048] The memory device 138 stores program code and instructions, executable by the processor 136. When executed by the processor 136, the program code and instructions cause the processor 136 to operate as described herein. The memory device 138 may include, but is not limited to only include, non-volatile RAM (NVRAM), magnetic RAM (MRAM), ferroelectric RAM (FeRAM), read only memory (ROM), flash memory and/or Electrically Erasable Programmable Read Only Memory (EEPROM). Any other suitable magnetic, optical and/or semiconductor memory, by itself or in combination with other forms of memory, may be included in the memory device 138. The memory device 138 may also be, or include, a detachable or removable memory, including, but not limited to, a suitable cartridge, disk, CD ROM, DVD or USB memory. Although illustrated separate from the processor 136, memory device 138 may be integrated with the processor 136.

[0049] Figure 4 is a functional block diagram of the ablation system 100. The controller 128 includes a primary DSP 156, a secondary DSP 158, and FPGA 160, and a user interface (UI) processor 162. The DSPs 156 and 158 control the temperature and output power delivered by the four ablation electrodes 112 contained in the catheter 104 by sending appropriate control signals to the FPGA 160. The FPGA 160 controls the power electronics (i.e., power supply 126 and RF output circuit 130), subject to control inputs from the UI processor 162. Both primary and secondary DSPs 156 and 158 communicate with the FPGA 160, the UI 162, and each other over a CAN bus 164. The primary and secondary DSPs 156 and 158 also communicate certain information to each other via a dedicated McBSP link 165.

[0050] In the illustrated embodiment, the UI processor 162 is responsible for presenting, such as via user interface portion 116, the current state of the system to the operator as well as providing a means for the operator to modify parameters such as ablation time and temperature. The UI processor 162 is also responsible for managing firmware upgrades, including the communication of new firmware images to the FPGA 160 and DSPs 156 and 158.

[0051] The FPGA 160 responds to control signals received from the primary DSP 156 via the CAN bus 164 to drive the power supply 126 and the RF output circuit 130 (specifically a buck regulator and an RF amplifier, respectively, in this implementation) that apply power to the catheter 104. It checks for periodic inputs from both the primary DSP 156 and the secondary DSP 158 in order to allow an RF output, and it monitors physical signals from an operator foot switch (not shown) and sends corresponding switch status updates to the DSPs 156 and 158 and to the UI processor 162.

[0052] The primary DSP 156 runs the main control loop, sampling the current, voltage, and temperature for each electrode, and adjusting the power delivered to each electrode to achieve the desired temperature, as will be described in more detail below. It is also the operating state master of the generator 102. While the operator interacts with the UI and with other physical components connected to

the generator 102 in ways that may result in a generator state change, the primary DSP 156 ultimately decides the state of the generator 102.

[0053] The primary DSP 156 is supervised in its task by the secondary DSP 158, which ensures that patient safety limits are not breached. The secondary DSP 158 independently measures output power, temperature, and other parameters set by the primary DSP 156. The secondary DSP 158 also verifies that the software running on the primary DSP 156 is operational.

[0054] Figure 5 is a block diagram of the primary DSP 156. Secondary DSP 158 is substantially the same as the primary DSP 156 shown in Figure 5. In the illustrated embodiment, both the primary and secondary DSPs 156 and 158 are 32-bit architecture microcontrollers each including a 32 bit processor 136. The DSP 156 supports a maximum clock frequency of 80MHz and includes a floating-point unit (FPU) for native single-precision floating-point operations, a fully-programmable control law accelerator (CLA) 166 for offloading time-critical operations from the processor 136, and a Viterbi control unit (VCU) for supporting complex math operations. The DSPs 156 and 158 also include embedded memory 138. The DSPs 156 and 158 contain 4 types of memory: RAM, Flash, OTP (One-Time Programmable) and ROM. Flash memory is divided into 8 sectors of equal size, for a total size of 256 Kbytes. A small amount (1K 16-bit words) of OTP memory is provided for storage of code or data that should not be erasable. This typically includes data such as serial numbers and device-specific addresses. 32K 16-bit words of Boot ROM are provided, which contain boot code to initialize the processor 136, various trigonometric data tables, such as Sine, Cosine, Arc Tangent and Taylor series coefficients. Also available are functions to erase and program the Flash memory.

[0055] The DSPs 156 and 158 include a set of internal peripherals 168. In order to avoid burdening the processor 136 with simple I/O and communications data transfer, a DMA controller 170 is provided to manage access to the memory 138, analog-to-digital converter (ADC) 172, USB 173, pulse width modulator (PWM) modules 174, and McBSP. Data transfers to and from any of these peripherals are possible without processor 136 intervention, increasing data

throughput through the system 100. The ADC 172 has two sample-and-hold circuits that can be sampled either simultaneously or sequentially. Each circuit is fed by one of 16 channels. The ADC 172 has 12-bit resolution. Both the primary DSP 156 and secondary DSP 158 use the ADC 172 to sample voltage, current, and thermocouple temperature for each electrode 112 as well as thermistor temperature and hand switch status.

[0056] For generating square waves with specific frequencies and duty cycles, the DSPs 156 and 158 each contain eight PWM modules 174, each PWM module 174 including two separate outputs. These modules are used for generating specific pulse trains. The PWM modules 174 are chained together by a clock synchronization scheme that allows them to operate as a single system when required. They support deadband generation with independent rising-edge and falling-edge delay control as well as PWM chopping by a high-frequency carrier signal. Also, several key registers controlling the PWM modules 174, including the time-base period and counter-compare registers, are able to be asynchronously updated without corruption or unwanted behavior through the use of shadow registers. The primary DSP 156 uses four PWM modules 174 to send on and off pulses to the pulse transformers (not shown) which provide power output to the four catheter electrodes 112. For each PWM module 174, on pulses are generated with one channel and off pulses with the other. In addition to being set for desired duty cycles, the compare values also include some overlap between channels to minimize the amount of time that no electrode 112 is connected to the output.

[0057] The DSPs 156 and 158 each include four high-resolution capture (HRCAP) modules 176 for taking high-resolution pulse width measurements. Each module includes a dedicated input capture pin, a 2-word FIFO for rising-edge captures, and a 2-word FIFO for falling-edge captures. The secondary DSP 158 uses the HRCAP modules 176 to measure the duty cycle of the output at each electrode.

[0058] The CLA 166 is an on-chip floating-point co-processor that has extensive access to the ADC 172 and PWM modules 174. The CLA 166 is intended to be capable of executing control loop software without intervention by the

main processor 136, thereby freeing up processing bandwidth for other tasks. The CLA 166 has its own instruction set, with support for addition, subtraction, multiplication, reciprocal, and square root calculation of single-precision floating point operands in four 32-bit result registers. Conversion to and from floating point of 16 and 32-bit integers is supported as well as the usual logical operations including arithmetic and logical shift. Branches and loops are supported and the existence of an indirect addressing mode in addition to the standard direct mode facilitates the processing of structured data. Throughput is enhanced by the provision of instructions that perform concurrent operations, such as multiply with parallel subtract and the ADC's feature of raising an "early interrupt" when starting its conversion process makes it possible for a program task to time execution so as to use the converted result "just-in-time".

[0059] The CLA's programs consist of tasks or interrupt service routines, which are code sequences whose starting address is contained in the interrupt vector register of its associated interrupt. When this interrupt fires, typically due to an ADC 172 conversion start or completion, the task is scheduled and run. Communication with the processor 136 is effected either through shared data memory blocks, which are permanently readable and writable by both CLA 166 and processor 136, or by selectively mapping memory areas for use by the CLA 166, access being controlled by access bits previously set by the processor 136.

[0060] Referring now to Figure 6, which is a diagram of the operating states 600 of the ablation system 100, upon system power up the software enters a temporary testing state 602 where all required subsystems are tested for correct operation. Examples include RAM tests and a cyclic redundancy check (CRC) of the software executable image. If all tests complete successfully, the system changes to a ready state 604. While in the ready state, patient information is entered and ablation parameters are configured on the UI 116. Meanwhile, the DSP software is also checking for catheter 104 presence and validity.

[0061] If one or more tests in the Check state fail, the system 100 transitions to an error state 606. This is a non-recoverable state and can only be

exited by a power cycle. Other errors detected in the system are treated either as nonrecoverable errors or as recoverable faults. If a recoverable fault occurs, the system transitions to a fault state 608. If a recoverable fault is cleared, the system transitions back to the ready state 604.

[0062] If an update is necessary and the DSP software is in the ready state 604, an update state 610 is entered, which disables all normal functionality and stores a new software image in flash memory. Once the new image has been successfully transferred, a power cycle is necessary to allow the new software to be loaded and run. If there is a communication issue during the image transfer or if the image is transferred but ends up being invalid after a CRC check (during testing state 602), the DSP software will request a retry from the UI 116. If a valid image is not successfully transferred after several retries, the system 100 will transition to the error state 606.

[0063] From the ready state 604, the system may transition to a diagnostic state 612 once a valid catheter 104 is connected, a message signifies that user configuration is complete, and a valid activation switch press is detected. During the diagnostic state 612, low-power measurements are taken in order to perform pre-ablation electrode 112 checks. The system 100 will be switched back to the ready state 604 on reception of a UI 116 message indicating that the operator has requested the transition.

[0064] If a valid activation switch press is detected while in the diagnostic state 612, the system will transition to the ablation state 614. In this state, all power and temperature control loops are activated, and the secondary DSP 158 performs its supervisory functions over the primary DSP 156. The system 100 transitions back to the ready state 604 if the configured ablation time is met (typically 90 seconds) or if an activation switch is pressed again.

[0065] The primary DSP 156 is the generator state machine "master." All state transitions are initiated by the primary DSP 156. If another processor desires that the generator transition to another state, it must first request that the primary DSP

156 make the transition. The secondary DSP 158 supervises the primary DSP 156 here as well and verifies that any state transition is valid.

[0066] The controller 128 is configured to control overall operation of the system 100 in concert with a user's instructions. In general, the controller 128 is configured, such as by instructions stored in the memory device 138, to simultaneously electrically couple the output voltage from the power supply 126 to electrodes 112 via the RF output circuit 130. Under some circumstances, such as because of a malfunction of the electrode, operator selection, etc., one or more of the electrodes 112 may be disabled and the disabled electrode(s) are not coupled to the output voltage.

[0067] The primary DSP 156 is responsible for regulating the temperature at each electrode 112, subject to oversight by the secondary DSP 158. With additional reference to Figures 7-12, the controller 128 and DSP 156 in particular, uses an outer loop 178 (shown in Figure 7) based on temperature and an inner loop 180 (shown in Figure 7) based on voltage to control system 100 using a plurality of fixed length output cycles 151 (shown in Figures 9-12). In the exemplary embodiment, each output cycle 151 lasts for five milliseconds. Other embodiments may use any other suitable length output cycle 151. As will be described in more detail below, each output cycle 151 includes a measurement period 150 during which various measurements are taken and an output period 154 during which the output voltage is coupled to one or more of the electrodes 112. If more than one electrode 112 is enabled, the measurement period 150 includes a plurality of measurement sub-periods, as will be described in more detail below.

[0068] Mechanical differences between electrodes 112, dissimilar contact qualities between the electrodes 112 and the artery wall, and other factors result in different power levels being required for each electrode 112 to achieve the same temperature set-point, e.g., a desired temperature to produce ablation. Generally, the primary DSP 156 controls temperature at each electrode 112 by modifying the output of a single buck regulator and exposing each of the electrodes 112 to the resulting output voltage for varying amounts of time (thus delivering

varying amounts of energy to each of the electrodes 112). The same output voltage is applied to each of the electrodes 112. The energy dissipated through each electrode 112, and therefore the temperature generated adjacent the electrode 112, is determined by how long each electrode 112 is coupled to the output voltage. Because, the output cycle 151 lasts for a fixed length of time, the maximum energy that may be delivered to any electrode 112 is determined by the output voltage of power supply 126. By increasing the output voltage of power supply 126 in the inner loop 180, controller 128 increases the maximum amount of energy that may be dissipated through an electrode (in particular an electrode 112 that is coupled to the voltage for the entire output period). Similarly, decreasing the output voltage of the power supply 126 decreases the maximum power dissipation through the electrodes 112.

[0069] With respect to the outer loop 178 of the control system, the difference in desired temperature versus measured or actual temperature, i.e., a temperature difference, is used to determine a desired power for each electrode 112. Both the primary and secondary DSPs 156 and 158 (shown in Figure 4) sample temperature values. Due to the limited number of sample-and-hold circuits in the ADC 172 (shown in Figure 5), the DSPs 156 and 158 collect these measurements at times other than when the voltage and current sampling is taking place. Therefore, all temperature measurements occur in the output period 154 of the output cycle 151.

[0070] To minimize the amount of hardware duplication, four thermocouple outputs are connected to multiplexers 140 (shown in Figure 3) controlled by GPIO pins on the DSPs 156 and 158. The output signal of the multiplexer 140 is appropriately conditioned before being fed as an input to the ADC 172. There are two multiplexers 140 and two conditioning circuits, one pair for each DSP 156 and 158. This allows a hardware failure for one DSP 156 or 158 to be caught by the other DSP 158 or 156. Because of settle time associated with multiplexing thermocouples, only one thermocouple is measured for each output cycle 151. In each output cycle 151 one of the temperature sensors is coupled to controller 128 through multiplexer 140. After the controller 128 samples the temperature sensor's signal, the multiplexer 140 switches its output to the next temperature sensor. The next temperature sensor is sampled during the next output

cycle 151. Thus, the delay between thermocouple measurements in the illustrated embodiment is four output cycles 151. This delay is accounted for in the compensator's poles and zeroes. In other suitable embodiments, however, the thermocouple measurements may be sampled more or less frequently within the scope of the present disclosure.

[0071] In addition to the four thermocouples, a "calibration" channel on the multiplexer 140 is used to measure a zero offset value. This offset is then applied to the four actual thermocouple readings. To minimize the delay to which the compensator is exposed, this measurement is taken infrequently, and never while the system 100 is controlling the temperature. Each DSP's software also samples a thermistor and uses that measurement to calibrate for ambient temperature.

[0072] With reference to Figure 7, to determine the desired power based on temperature difference, the primary DSP 156 uses an infinite impulse response (IIR) filter implementation of pole-zero compensation. The poles and zeroes for this compensator have been determined using analog modeling. When the generator is in diagnostic mode this portion of the control is bypassed and the desired power for each electrode 112 is simply 0.5W.

[0073] In the inner loop 180, the controller 128 determines a target output voltage for the power supply 126 that will achieve the desired power delivery to the electrode 112 (sometimes referred to herein as the maximum demand electrode) that has the highest desired power determined in the outer loop 178. The energy that would be dissipated through the maximum demand electrode if it were coupled to the target output voltage for the entire output cycle 151 is determined. The target output voltage is determined based on the desired energy dissipation for the maximum demand electrode and an energy dissipation difference signal from a previous output cycle 151. The energy dissipation difference signal is the difference between the previous cycles desired energy dissipation through the maximum demand electrode and the actual energy dissipation through the maximum demand electrode. To determine the target output voltage for the buck regulator based on the difference, the primary DSP 156 uses an IIR filter implementation of pole-zero compensation. The

poles and zeroes for this compensator have been determined using analog modeling. When the output cycle begins, the controller 128 causes the power supply 126 (shown in Figure 3) to operate to produce the target output voltage.

[0074] As described above, the target output voltage for the power supply 126 is determined in the inner loop 180 by the electrode 112 with the highest desired power, and the output duty cycle for that electrode 112 is the maximum possible duty cycle. Any electrode 112 with less demand is driven at a lower duty cycle, i.e., for less time in the output cycle 151. As may be best seen in Figures 9 and 10, the maximum duty cycle is a function of the number of enabled electrodes 112. Because of the measurements that need to be taken at the beginning of the output cycle 151, the output period 154 of the output cycle 151 is less than the entire output cycle 151. If only one electrode 112 is enabled, the maximum duty cycle is 100%. If more than one electrode 112 is enabled, the maximum duty cycle for an electrode 112 is reduced by the amount of time that the electrode 112 will need to be disconnected while measurements are being taken with other electrodes 112. Thus, the maximum duty cycle with four electrodes 112 enabled is 92.8% if the maximum demand electrode 112 is one of the electrodes 112 that is included in the combination measurement sub-period 152. In the example shown in Figure 9, the maximum demand electrode 112 is not one of the electrodes 112 included in the combination measurement sub-period 152. If, as shown in Figure 9, the maximum demand electrode is not part of the combination measurement sub-period 152, the maximum duty cycle is 90.4%. If only three electrodes 112 are enabled, the maximum duty cycle is 95.2% for the electrodes 112 in the combination measurement sub-period 152 and 92.8% for the electrode 112 not in the combination measurement sub-period 152.

[0075] The minimum duty cycle for an enabled electrode 112 is equal to the time that it must be connected to the output to take measurements at the beginning of the output cycle 151. If the required duty cycle for an electrode 112 is less than or equal to the electrode's minimum duty cycle, the electrode 112 will be connected for its minimum duty cycle during the measurement period 150 and will not be connected during the output period 154.

[0076] During an output cycle 151, the primary DSP 156 switches electrodes 112 on or off by sending on or off pulses to a pulse transformer (not shown). As shown in Figure 12, dead time between electrode 112 switching is avoided by switching on the next electrode 112 before the current one is switched off. This eliminates any electrical transient that might otherwise result from this switching.

[0077] The length of the output cycle 151 is chosen to substantially minimize the minimum duty cycle while not impacting responsiveness of the control system. If the minimum duty cycle were too large, controller 128 would not be able to deliver power low enough to keep electrodes 112 with very good arterial contact from overshooting the temperature set-point. If the output cycle 151 were too long, the control system would not be able to react quickly enough to changing conditions.

[0078] As shown in Figure 8, when the target output voltage is delivered to the electrodes 112 within an artery 142, energy is dissipated in a therapeutic resistance 144 and a common return path resistance 146. Dissipation of energy through the therapeutic resistance 144 results in the local temperature increases in the wall of the artery 142 desired for ablation. Energy dissipated through the common return path resistance 146 does not increase the temperature in the wall of the artery and is thus considered a non-therapeutic dissipation. Accordingly, to accurately determine the energy dissipated in the therapeutic resistance 144, the values of the therapeutic resistances 144 and the common return path resistance 146 need to be determined. The values for the resistances 144 and 146 will change based on location of the electrodes 112 relative to the return electrode 106, the quality of the contact between electrodes 112 and the walls of the artery 142, the temperature of the walls of the artery 142, etc. Therefore, during the measurement period 150 at the beginning of each output cycle 151, controller 128 acquires several measurements to allow it to determine the common return path resistance 146 and the therapeutic resistances 144.

[0079] The primary DSP 156 calculates impedance and power for each electrode 112 based on a set of simultaneously sampled voltage-current pairs

taken during the measurement period 150 at the beginning of each output cycle 151 using its ADC 172. Root mean square (RMS) voltage and RMS current for each electrode path, i.e., the path from the connected electrode(s) 112 to the return electrode 106, are also calculated. RMS values are needed because the output voltage that is being sampled is not direct current (DC). There is a single current sensor 149 for each DSP 156 and 158 on the return path for all electrodes 112. Therefore, in order to measure the current flowing through a single electrode 112, that electrode 112 must be the only electrode 112 connected to the output during its measurement period.

[0080] Because the generator 102 operates with multiple electrodes 112 simultaneously connected to the output, calculating the power dissipated at a specific electrode 112 requires the common return path resistance 146 to be determined and accounted for. To calculate this value, additional voltage and current measurements must be taken with at least two electrodes 112 connected to the output. This measurement period is referred to as the "combo" measurement period. If only one electrode 112 is enabled, the common return path resistance 146 cannot be determined, but accurate computation of power delivered when only a single electrode 112 is enabled does not require such a determination of the common return path resistance 146.

[0081] During the measurement period 150 at the beginning of an output cycle 151, voltage and current are measured with each enabled electrode 112 connected to the target output voltage by itself while all other electrodes 112 are disconnected, and with two electrodes 112 connected while all other electrodes 112 are disconnected (i.e., combo measurement period). As graphically shown in Figures 9-12, the measurement period 150 of the output cycle 151 is divided into a number of equal length measurement sub-periods 152. In the illustrated embodiment, each measurement sub-period 152 lasts for one hundred and twenty microseconds. The number of measurement sub-periods 152 is determined by the number of electrodes 112 to be enabled. For example, there is one more measurement sub-period 152 than the number of electrodes 112 to be enabled. Accordingly, Figures 9 and 11 have five measurement sub-periods 152 with four electrodes 112 enabled, and Figure 10 has

four measurement sub-periods 152 with three electrodes 112 enabled. During each of the measurement sub-periods 152, except the last sub-period 152, a different one of the electrodes 112 is coupled to the target output voltage. Voltage sensors 148 (Figure 8) are sampled by the controller 128 to measure the voltage across the therapeutic resistance 144 of a particular electrode 112 and the common return path resistance 146. The path from a particular electrode 112 through the common return electrode 106 is sometimes referred to herein as a branch. A current sensor 149 (shown in Figure 8) is sampled by controller 128 to determine the current through the branch to which the target output voltage is coupled. During the last measurement sub-period 152, two electrodes 112 are coupled to the target output voltage defining a combined branch. The voltage sensors 148 provide the voltage across the combined branch and the current sensor 149 detects the common return path current. In other embodiments, the combined branch may be measured during a sub-period 152 other than the last sub-period 152.

[0082] For mitigation purposes, the secondary DSP 158 (shown in Figure 4) also calculates impedance, average power, etc. for each electrode 112. Besides measuring voltage and current, it must also measure the duty cycle of the power output at each electrode 112, as controlled by the primary DSP 156 (shown in Figure 4), in order to calculate average power. The HRCAP module 176 (shown in Figure 5) is used to make this measurement by capturing the times between "on" and "off" pulses generated by the PWM modules 174 on the primary DSP 156. Since there are eight signals being captured and only four capture devices, four set-reset (SR) latches (not shown) are utilized. Each latch is set by an "on" pulse and reset by an "off" pulse, and the HRCAP modules 176 capture the high and low times of the output signals from the latches.

[0083] Since the primary DSP 156 controls when the electrodes 112 are connected to the output, a synchronization mechanism is required for the secondary DSP 158 to take voltage and current measurements while electrodes 112 are individually connected to the output. The HRCAP module 176 is used for this functionality as well, with interrupts being generated on rising edges. When the output of a latch connected to an HRCAP module 176 transitions from low to high, it

is an indication that the associated electrode 112 has been connected to the output. When such an interrupt occurs, if no interrupts have been generated on the other HRCAP modules 176, the secondary DSP 158 can infer that the particular electrode 112 is individually connected to the output and that it can kick off voltage and current sampling for that electrode.

[0084] An issue with using the HRCAP peripheral for measurement synchronization is presented when an electrode 112 has been connected for the maximum duration during an output cycle 151 and is then about to be individually connected for measurements at the start of the next output cycle 151. In this case, the associated SR latch will never be reset, and the HRCAP module 176 will not detect a rising edge to indicate that the electrode 112 is now individually connected. To overcome this, the primary DSP 156 generates a fifth PWM signal which is synchronized with the other PWM modules 174 used for connecting and disconnecting electrodes 112. This fifth signal briefly disables the SR latches once per output cycle, ensuring that the HRCAP modules 176 on the secondary DSP 158 will always detect a rising edge for the first measurement sub-period 152 of an output cycle 151.

[0085] As shown in Figures 9-12, following completion of the measurement period 150, the output period 154 begins and controller 128 couples the target output voltage to all of the electrodes 112. The controller 128 uses the current measured through each branch during the measurement period 150 and the calculated therapeutic resistance 144 to determine the amount of energy dissipated through each electrode 112 during the measurement period 150 and to determine a remaining amount of energy to be dissipated through each electrode 112. The controller 128 generally keeps each electrode 112 coupled to the target output voltage until the energy dissipated through the electrode 112 during the output cycle 151 reaches the desired energy dissipation determined based on the desired power calculation of the outer loop 178. The last electrode 112 coupled to the target output voltage is maintained coupled to the target output voltage until the end 155 of the output cycle 151. Thus, in the illustrated embodiment with all four electrodes 112 enabled, there are four configurations during the output period 154. In order of occurrence, the

configurations are: all four electrodes 112 coupled to the target output voltage, three electrodes 112 coupled to the target output voltage, two electrodes 112 coupled to the target output voltage, and one electrode 112 coupled to the target output voltage. At the beginning of any configuration, the remaining energy to be dissipated through an electrode 112 still coupled to the target output voltage is its desired energy dissipation less the energy dissipated during the measurement period 150 and during any earlier configurations.

[0086] The amount of time each electrode 112 is switched on (i.e. electrically coupled to the target output voltage, during the output period 154 of the output cycle 151) is determined by an iterative calculation based on the desired energy dissipation through each electrode 112. Until all electrodes 112 are dropped, the remaining energy to deliver is calculated for each electrode 112 still switched on, (for the initial calculation, energy delivered during the measurement period 150 is also taken into account). Based on the earlier measured output voltage, the common return path resistance 146, and the calculated resistances 144 of the remaining 'on' electrodes 112, updated branch currents are calculated. Based on the updated branch currents and the remaining energy to deliver to each electrode 112, the remaining on time for each electrode 112 is calculated. The on time for the electrode 112 with smallest on time is recorded and that electrode is turned off for the next iteration. Because at least one electrode 112 is switched on at all times and the output cycle is fixed at 5 milliseconds (ms), the electrode 112 with the largest on time (i.e., the maximum demand electrode) is left on for the entire duration of the output period 154. The difference between this electrode's actual on time and desired on time is used to calculate the energy dissipation difference that is used as feedback for the inner loop 180.

[0087] During the output period 154 following the measurement period 150 of the output cycle 151, thermistor and thermocouple measurements are taken. The temperature measurements cannot be taken while the ADC 172 is being used for voltage and current measurements. Temperature measurements take approximately 50 microseconds (μ s) each. Thermocouple measurements require a 4ms delay between switching the thermocouple multiplexer 140 and taking the

measurement in order for the signal to settle out. For this reason, only a single thermocouple measurement is taken during an output cycle 151. This means the shortest possible temperature loop 178 (shown in Figure 7) period is 20 ms, since each temperature is updated once every four cycles. After the thermocouple measurement is completed, the multiplexer 140 (shown in Figure 3) is switched to the next channel. This results in approximately 5ms between the multiplexer 140 being switched and the measurement being taken. Due to the thermocouple settle time, the calibration multiplexer channel is only measured while the temperature control loop is inactive. Since any change should occur slowly and should not be severe, using calibration measurements that are taken while the controls are inactive is sufficient. Similar to sampling of the voltages and currents, all temperature ADC sampling is handled by the CLA 166. Once sampling is complete, the processor 136 averages and scales these samples to compute actual temperature values.

[0088] After temperature measurements have been taken and the thermocouple multiplexer 140 has been updated, the remainder of the output cycle 151 time is available for control loop computations. The outer loop 178 corresponding to the electrode 112 with the currently updated temperature measurement is run, followed by the voltage loop 180. This yields an effective outer loop period of 20ms and an inner loop period of 5ms. While the target output voltage of power supply 126 is set immediately, the newly calculated electrode 'on' times are not put into effect until the next output cycle 151.

[0089] During the control loop calculations, the controller 128 uses the measured voltages and currents for each branch, including the combined branch, to determine the value of the therapeutic resistances 144 and the common return path resistance 146. For each electrode 112, controller 128 determines a branch resistance, which is the equivalent resistance of the combination of resistances 144 and 146, by dividing the measured voltage by the measured current for that branch. Controller 128 determines a combined branch resistance for the combined branch by dividing the measured voltage across the combined branch by the measured common return path current for the combined branch. The common return path resistance 146 is determined by

$$RC = RX12 - \sqrt{(RX1 - RX12) * (RX2 - RX12)} \quad (1)$$

where RC is the common return path resistance 146, RX12 is the combined branch resistance, RX1 is the branch resistance of the first branch included in the combined branch, and RX2 is the branch resistance of the second branch included in the combined branch. Because each therapeutic resistance 144 is in series with common return path resistance 146 in its respective branch, the therapeutic resistances associated with each electrode may be determined by subtracting the common return path resistance 146 from its determined branch resistance.

[0090] As each electrode 112 reaches its desired energy dissipation and is decoupled from the target output voltage, the current through the remaining electrodes 112 and the power dissipated through the associated therapeutic resistances 144 changes. Accordingly, controller 128 calculates the power dissipation in the therapeutic resistances 144 and the remaining energy to be dissipated in the therapeutic resistances 144 for all of the configurations which will occur in the output cycle 151. Controller 128 uses the determined values of therapeutic resistances 144, common return path resistance 146, and the target output voltage to determine the current that will flow through each therapeutic resistance 144 and the power that will be delivered to each therapeutic resistance in each configuration. For each configuration, the amount of energy remaining to be dissipated through each electrode 112 (desired energy less previously delivered energy) is calculated and divided by the power that will be dissipated in the associated therapeutic resistance 144 during that configuration to determine how long the target output voltage would need to be coupled to each electrode 112 at the calculated power to achieve the desired energy dissipation. In each configuration, except the single electrode 112 configuration, the electrode 112 having the least amount of time remaining to reach its desired energy dissipation determines when the configuration ends.

[0091] As the output period 154 progresses, the electrodes 112 are decoupled from the target output voltage at the times calculated as described above. For all but the last electrode 112, the desired energy dissipation will have been reached. As described above, however, the last electrode 112 coupled to the target

output voltage remains coupled to the target output voltage until the end of the output cycle 151 regardless of whether or not the desired energy for that electrode 112 has been delivered. The difference between the desired energy dissipation for the final electrode and the actual energy dissipation through that electrode is an energy dissipation difference that is used as feedback for the determination of the target output voltage for the next output cycle 151.

Example Timing Calculations

[0092] An example illustrating the timing calculations performed by system 100 will now be described. In this example, system 100 includes three enabled electrodes 112 referred to as E1, E2, and E3. The therapeutic resistances 144 associated with E1, E2, and E3 are identified as resistances R1, R2, and R3. RC is the common return path resistance 146. E1 and E2 were simultaneously coupled to the target output voltage during the combination measurement sub-period 152 to form a combination branch. The measured branch currents for E1, E2, and E3 are identified by IX1, IX2, and IX3, respectively. The current through the combination branch during the combination measurement sub-period is IX12. Each measurement sub-period (referred to in this example as 'm') is 2.4% of the output cycle 151 and the output cycle 151 is 0.005 seconds (referred to in this example as 'Tmux'). For simplicity, measured and calculated values are rounded in this example.

[0093] The previously determined desired amounts of power to be applied to E1, E2, and E3 are 3.7 watts (W), 4.3W and 4.1W, respectively. With an output cycle 151 of 0.005 seconds, the desired energy to be dissipated through R1, R2, and R3 (via E1, E2, and E3 respectively) is 0.019 joules (J) for E1, 0.022J for E2, and 0.021J for E3.

[0094] During the measurement period 150, the target output voltage applied to E1, E2, and E3 was measured as fifty volts. The branch current IX1 was measured as 0.333 ampere (A), the branch current IX2 was measured as 0.25A, the branch current IX3 was measured as 0.167A, and the combination branch current IX12 was measured as 0.41A.

[0095] Branch resistances are calculated for each branch by dividing the measured voltage by the measured branch resistance. Thus, for E1, fifty volts divided by 0.333A gives a value of 150 ohms (Ω) for the branch resistance RX1. The branch resistances RX2 and RX3 are similarly calculated to be 200 Ω and 300 Ω , respectively. Combination resistance RX12 is calculated to be 121.875 Ω . The common return path resistance 146 is calculated using:

$$RC = RX12 - \sqrt{(RX1 - RX12) \cdot (RX2 - RX12)} = 75\Omega \quad (2)$$

For each branch, the therapeutic resistance is determined by subtracting RC from the branch resistance. Thus,

$$R1 = RX1 - RC = 75\Omega \quad (3)$$

$$R2 = RX2 - RC = 125\Omega \quad (4)$$

$$R3 = RX3 - RC = 225\Omega \quad (5)$$

[0096] After the individual resistive elements have been calculated, the controller 128 iteratively calculates the remaining on-times for each electrode 112. The measurement cycle has delivered a portion of the target energy to each load element and that energy must be subtracted from the target energy to compute remaining energy for each electrode 112. The amount of energy remaining to be delivered to R3 through E3 is

$$JR3 = J3 - (m \cdot T_{\text{mux}} \cdot IX3^2 \cdot RX3) = 0.0195J \quad (6)$$

where J3 is the previously determined amount of energy to be delivered through E3. Because E1 and E2 were turned on individually and in combination, the calculation of the amount of energy delivered to R1 and R2 must take into account the energy delivered during both the individual measurement and the combination measurement. Accordingly, the remaining energy to be delivered to R1 through E1 is

$$JR1 = J1 - (m \cdot T_{\text{mux}} \cdot IX1^2 \cdot RX1) - \left[m \cdot T_{\text{mux}} \cdot \left[\frac{v - (IX12 \cdot RC)}{R1} \right]^2 \cdot RX1 \right] = 0.01532J \quad (7)$$

where $J1$ is the previously determined amount of energy to be delivered through $E1$, and v is the measured voltage. The remaining energy to be delivered to $R1$ through $E2$ is

$$JR2 = J2 - (m \cdot T_{\text{mux}} \cdot IX2^2 \cdot RX2) - \left[m \cdot T_{\text{mux}} \cdot \left[\frac{v - (IX2 \cdot RC)}{R2} \right]^2 \cdot RX2 \right] = 0.01943J \quad (8)$$

where $J2$ is the previously determined amount of energy to be delivered through $E2$.

[0097] At the beginning of the output period 154, all electrodes 112 are turned on. The time needed to deliver the remaining energy to each electrode 112 in this state ('All-On') is calculated for each electrode 112. The lowest time calculated indicates which electrode 112 to turn off first. Initially, the branch currents need to be calculated for the All-On state. The voltage across RC is calculated as

$$VRC = \frac{RC \cdot v}{RC + \left[\frac{1}{\left(\frac{1}{R1}\right) + \left(\frac{1}{R2}\right) + \left(\frac{1}{R3}\right)} \right]} = 32.955V \quad (9)$$

The current through each resistor is calculated by dividing the voltage across the resistor ($v - VRC$) by the calculated resistance. This results in a current ($I1$) of 0.227A through $R1$, a current ($I2$) of 0.136A through $R2$, and a current ($I3$) of 0.076A through $R3$. The remaining on times are calculated as

$$TR1 = \frac{JR1}{I1 \cdot V} = 1.348 \times 10^{-3} s \quad (10)$$

$$TR2 = \frac{JR2}{I2 \cdot V} = 2.85 \times 10^{-3} s \quad (11)$$

$$TR3 = \frac{JR3}{I3 \cdot V} = 5.148 \times 10^{-3} s \quad (12)$$

where $TR1$ is the remaining time that $E1$ must be connected in the current state (All-On) to deliver its targeted energy, $TR2$ is the remaining time that $E2$ must be connected in the All-On state to deliver its targeted energy, and $TR3$ is the remaining time that $E2$ must be connected in the All-On state to deliver its targeted energy.

E1 has the lowest time and will be the first to be switched off. This will occur about 1.35 milliseconds after the measurement period 150 ends, or 1.708 milliseconds into the output cycle, for a duty cycle of about 34.16%. In the controller 128, E1 is turned off and the calculation sequence is repeated for the “Two-On” switch state. Initially, the remaining energy to be delivered is calculated by subtracting the amount of energy delivered during the All-On state from the previously calculated remaining energy. This results in a new JR2 of 0.01024J and a new JR3 of 0.01439J. The new voltage across RC is calculated by

$$VRC = \frac{RCv}{RC + \left[\frac{1}{\left(\frac{1}{R2}\right) + \left(\frac{1}{R3}\right)} \right]} = 24.138V \quad (13)$$

The current through each resistor is calculated by dividing the voltage across the resistor (v-VRC) by the calculated resistance. This results in a current (I2) of 0.207A through R2 and a current (I3) of 0.115A through R3. The remaining on times are calculated as

$$TR2 = \frac{JR2}{12 \cdot v} = 9.89968 \times 10^{-4} s \quad (14)$$

$$TR3 = \frac{JR3}{13 \cdot v} = 2.50455 \times 10^{-3} s \quad (15)$$

E2 now has the lowest time calculated and will be the next output to be switched off. This will occur 990 microseconds after the onset of the ‘Two On’ switch state, or 2.698 milliseconds into the output cycle for a duty cycle of 53.96%.

[0098] The calculation sequence is repeated for the “One-On” state. Although the last electrode 112 will remain on for the entire output period 154, the difference between the calculated time remaining and the time remaining in the output period 154 is used to calculate the energy dissipation difference term for use by the inner control loop 180 to change the output voltage of the power supply 126. The remaining energy to be delivered is calculated by subtracting the amount of energy delivered during the Two-On state from the remaining energy calculated in the last

iteration. This results in a new JR3 of 0.00870447J. The new voltage across RC is calculated by

$$VRC = \frac{RCv}{RC=JR3} = 12.5V \quad (16)$$

and the current (I3) is calculated as 0.167A. The remaining on time for E3 is:

$$TR3 = \frac{JR3}{13-v} = 1.04454 \times 10^{-3} s \quad (17)$$

E3 will hit its output energy target for this output cycle 151 by remaining on for 1.045 milliseconds after the onset of the 'One-On' switch state, or 3.743 milliseconds into the output cycle, for a duty cycle of 74.86%. The output cycle, however is 5 milliseconds in length. The difference between the time when E3 should be turned off to meet its energy target and the end of the output cycle 151 is a difference value of 1.257 milliseconds. This difference value indicates that surplus power was delivered. The difference term is used as an input to the inner voltage loop 180 IIR filter to lower the output voltage of the power supply 126.

[0099] Leaving the example and referring now to Figures 3-5, in addition to control loop measurements, each DSP 156 and 158 must be able to update watchdog registers in the FPGA 160 before the FPGA 160 generates a system error. The time before an error condition will be generated is approximately 300ms. While this is a relatively long time period compared to the control loop timings, it is not an insignificant consideration given that communication with the FPGA 160 is accomplished using CAN communications.

[00100] Each DSP 156 or 158 also needs to communicate mitigation data to the other DSP 158 or 156. The data being exchanged must be agreed upon by both DSPs 156 and 158. This data includes measurement data (e.g., temperature) and state data (e.g., Ready or Diagnostic state). If there is disagreement or a lack of communication for approximately 100ms, at least one of the DSPs 156 or 158 will generate a system error. A CAN message will be sent to the FPGA 160 to discontinue output, and CAN messages will be sent to the UI processor 162 and to the other DSP

158 or 156 indicating the error. Mitigation data is exchanged using the McBSP peripheral every 10ms.

[00101] To limit the potential consequences of critical component failure, the secondary DSP 158 monitors the activities of the primary DSP 156. The FPGA 160 is also designed to cut off all power if it does not receive heartbeat packets within a certain timeframe from either DSP 156 or 158.

[00102] To mitigate the possibility of a program malfunction due to erroneous memory or bus operation, the memory components attached to the system are checked both at boot time and during normal operation. The flash memory 138 is verified by computing a cyclic redundancy check (CRC) over its contents and comparing it to a previously stored value. RAM tests typically consist of three sections. One section tests the memory 138 itself, and the other two test the data and address bus connections. Since the RAM in this implementation is on-chip, the bus tests are not required; if the buses are not operational, the chip will not function. The RAM test is executed once at system boot and continuously thereafter, running in the lowest-priority task. The check itself consists of reading a memory location, storing its bitwise inverse at the same location, re-reading the result, computing the bitwise exclusive-OR with the original value and ensuring the result is bitwise all ones before restoring the original value. This ensures that all the bits in the memory location can correctly store both ones and zeros. Interrupts must be disabled immediately prior to the first read of the value and re-enabled directly after restoring the original value. Furthermore, it is important to maintain the global state of the interrupt enable/disable register, to avoid inadvertently re-enabling interrupts after another routine has disabled them. Because the processor 136 has an 8-stage pipeline, a flush operation is required before interrupts are re-enabled after a memory test to prevent premature reads from returning corrupted values.

[00103] The correct function of the control loop regulating the operating parameters of the catheter 104 (output power and temperature) depend on three issues: the quality of the connection of the analog components to the input of the ADCs 172, the correct operation of the ADCs 172 themselves, and valid outputs to

the control loop calculation. The secondary DSP 158, therefore, verifies both the connection of the analog components and the ADC 172 values of the primary DSP 156 by measuring the output current, voltage, and temperature of each electrode 112 via independent analog connections and its own ADCs 172. The sensor values read by the ADC 172 of the primary DSP 156 are compared to the values read by the ADC 172 of the secondary DSP 158, and vice versa. Periodically, both DSPs 156 and 158 exchange their conversion results and verify that the values agree.

[00104] Because the connection to each sensor (temperature, voltage, or current) is independent, but the sensor itself is shared between the two DSPs 156 and 158, it is possible to detect a failing sensor by checking whether or not the ADCs 172 of both DSPs 156 and 158 are reading values that are out of range. A poor connection between a DSP 156 or 158 and one of its sensors, or a faulty ADC 172 may be detected when differing values for the same sensor are found on either DSP 172.

[00105] The output of the control loop calculation is verified to be within defined limits by the secondary DSP 158 using calculated values from the control loop of the primary DSP 156. The secondary DSP 158 will only issue an alert and abort ablation if the calculated values are out of range for longer than a certain period of time, to prevent frequent aborted ablation sessions due to brief transients that are of no consequence.

[00106] Confirmation of the correct operation of all three processing components, i.e., the FPGA 160 and the DSPs 156 and 158, of the system 100 is established by the periodic transmission of RPC watchdog packets from one node to the other two. A certain level of confidence is attained by the reception of periodic status messages by both DSPs 156 and 158 from the FPGA 160, but this does not confirm the normal operation of RPC packet reception by the FPGA 160. For this reason, both DSPs 156 and 158 periodically transmit RPC watchdog packets to the FPGA 160. A similar argument applies to the verification of operation of the primary DSP 156 by the secondary DSP 158. Accordingly, RPC watchdog messages from the

secondary DSP 158 to the primary DSP 156 (and vice versa) guarantee prompt detection of problems in either component.

[00107] The frequency of the RF energy emitted is important to the ablation procedure. For this reason the secondary DSP 158 decomposes the output waveform into its constituent frequencies via fast Fourier transform (FFT). This permits verification of the correct frequency setting as well as the output waveform, to avoid the emission of unwanted higher frequency sidebands.

[00108] In some embodiments, the determined common return path resistance 146 (shown in Figure 8) is also utilized by the controller 128 for additional features of the ablation system 100. As described above, the ablation system 100 (shown in Figure 1) includes a single return electrode 106 that is shared with all of the electrodes 112 resulting in a common return path for all of the electrodes 112. Energy dissipated in the common return path resistance 146 does not increase temperatures close to electrodes 112 and does not aid ablation. The larger the common return path resistance 146, the more energy is wasted in nontherapeutic dissipation. Accordingly, in some embodiments, controller 128 generates a notification when the common return path resistance exceeds a threshold value, thereby alerting the operator that the common return path resistance 146 is too high. The operator may attempt to reposition the return electrode 106 to reduce the common return path resistance 146. Alternatively, or additionally, the operator may connect a second return electrode (not shown) to generator 102 to reduce the common return path resistance 146. The notification may be an audible or visual notification, such as by using one or more of indicators 120. In some embodiments, the notification is a unitless visual notification. For example, the notification may be a green light if the common return path resistance 146 is equal to or below the threshold value and a red light if the common return path resistance 146 exceeds the threshold value. Additional threshold values and notifications may be added to increase the resolution of the notification. In some embodiments, the controller 128 is configured to disable the electrodes 112, i.e. decouple the electrodes 112 from the target output voltage and prevent re-coupling to the output voltage, when the common return path resistance 146 exceeds the threshold. In other embodiments, the controller 128 is configured to disable the

electrodes 112, when the common return path resistance 146 exceeds a second threshold greater than the first threshold. Thus, the controller 128 may alert the operator when the common return path resistance 146 exceeds a first threshold value and disable the electrodes 112 if the common return path resistance 146 continues to increase above a second threshold value.

[00109] Because the controller 128 determines the common return path resistance 146 and the therapeutic resistances 144, the controller 128 is able to accurately determine the power applied to the therapeutic resistances 144. In some embodiments, by combining the accurate power measurements with the temperature measurements for each electrode 112, controller 128 determines the thermal gain for each electrode 112. The thermal gain of an electrode 112 is a change in temperature produced by an amount of power. In the present disclosure, thermal gain is generally the ratio of a change in temperature measured at an electrode 112 (degrees Celsius) to the amount of power applied to that electrode (in watts). The thermal gain of an electrode 112 may change depending on, for example, the size of the electrode 112, the material composition of the electrode 112, the size of an artery in which the electrode 112 is located, the amount of fluid surrounding the electrode 112, the thermal transfer characteristics of the environment around the electrode, and the quality of contact between the electrode and the wall of artery 142. For a particular electrode 112 in a particular artery, a higher thermal gain generally indicates better apposition, or contact, with the wall of the artery than a lower thermal gain. Thus, controller 128 is configured to utilize the thermal gain of the electrodes 112 as an indication of the quality of contact between electrodes 112 and the artery wall. The controller 128 generates a notification corresponding to the thermal gain, and thus the contact quality, for each electrode 112. The notification may be an audible or visual notification, such as by using one or more of indicators 120. In some embodiments, the notification is a unitless visual notification. For example, the notification may be a green light if the contact quality is good and a red light if the contact quality is poor. Additional threshold values and notifications may be added to increase the resolution of the notification. For example, a numerical scale, e.g. integers one through ten, may be displayed to the operator with one end of the scale representing very good contact

quality and the opposite end indicating very poor contact quality. Numbers between the ends indicate graduation in quality between very good and very poor. In some embodiments, the controller 128 is configured to disable the electrodes 112, i.e. decouple the electrodes 112 from the target output voltage and prevent re-coupling to the output voltage, when the thermal gain is less than a threshold thermal gain.

[00110] In one particular embodiment, the controller 218 is configured to limit a maximum power applied to the electrodes 112 based at least in part on the determined thermal gain of each electrode 112 (sometimes referred to herein as adaptive power limiting). During operation, the maximum power delivered to each electrode is generally limited by a predetermined power limit. In one example, the power limit is eight watts. In other embodiments, however, the power limit may be other than eight watts (higher or lower). The determined thermal gain of each electrode 112 is compared to a predetermined thermal gain threshold that generally indicates adequate contact quality. The thermal gain threshold is twenty degrees Celsius per watt ($20^{\circ}\text{C}/\text{W}$). The exemplary thermal gain threshold of twenty degrees Celsius per watt ($20^{\circ}\text{C}/\text{W}$) was determined based on animal study data for nominal renal artery sizes of five millimeters to six millimeters. Other artery sizes and/or other factors may dictate use of a different thermal gain threshold (whether larger or smaller). In another embodiment, the thermal gain threshold is about fifteen degrees Celsius per watt ($15^{\circ}\text{C}/\text{W}$). In other embodiments, the thermal gain threshold may be any suitable threshold value determined to indicate a minimum arterial contact for an ablation procedure using a particular ablation system. Each electrode 112 that has a thermal gain above the threshold is controlled as described herein subject to the predetermined power limit. Any electrodes for which the thermal gain is less than the thermal gain threshold are limited to a reduced power limit until the thermal gain for that electrode 112 reaches the thermal gain threshold.

[00111] The controller 218 determines the reduced power limit, for electrodes 112 having a thermal gain less than the threshold thermal gain, as a function of the amount by which the thermal gain of the electrode 112 is less than the thermal gain threshold. In a more particular embodiment, the reduced power limit is calculated by:

$$P_{limit} = MaxP_{limit} - ScalingFactor * (Threshold - ThermalGain) \quad (18)$$

where P_{limit} is the reduced power limit, $MaxP_{limit}$ is the original (maximum) power limit, $ScalingFactor$ is a scaling factor, $Threshold$ is the thermal gain threshold, and $ThermalGain$ is the determined thermal gain. The scaling factor in one exemplary embodiment is 0.5. In such an embodiment, the controller 218 reduces the power limit by one half of a watt for each degree Celsius per watt that the determined thermal gain is below the thermal gain threshold. In another exemplary embodiment, the scaling factor may be 0.3. It is understood that in other embodiments the scaling factor may be other than as set forth above without departing from the scope of this disclosure.

[00112] The adaptive power limiting is not applied at the beginning of an ablation procedure in order to permit the thermal gain values to reach equilibrium as the electrode temperature ramps up to the temperature set-point. Rather, in one embodiment, the adaptive power limit feature is activated upon the occurrence of a suitable startup condition. The startup condition may be, for example, the first to occur of the electrode temperature reaching a temperature threshold or the energy dissipated through the electrode reaching an energy threshold. In one exemplary embodiment, the temperature threshold is sixty-five degrees Celsius (65°C) and the energy threshold is twelve joules (12J). Alternatively, the temperature threshold and/or the energy threshold may be any other suitable respective threshold. For each electrode 112, after at least one of the startup conditions has been met, the adaptive power limit described above is applied to that electrode as applicable.

[00113] Figure 24 is a flow diagram of one exemplary implementation of adaptive power limiting in the ablation system 100. For this example, the maximum power limit is eight watts, the thermal gain threshold is twenty degrees Celsius per watt (20°C/W), the scaling factor is 0.5, and the startup condition is the first to occur of the electrode temperature reaching a startup temperature threshold or the energy dissipated through the electrode reaching a startup energy threshold. An ablation procedure begins at step 2400 and the power limit (P_{limit}) is set to eight watts. At 2402, the controller 218 determines whether or

not the temperature (t) at an electrode 112 is greater than or equal to the startup temperature threshold of sixty-five degrees Celsius (65°C). If not, the controller determines at 2404 whether or not the energy dissipated through the electrode 112 equals or exceeds the startup energy threshold of twelve joules (12J). If not, the controller 218 returns to 2402. If the temperature exceeds the startup temperature threshold at 2402 or the energy exceeds the startup energy threshold at 2404, the controller proceeds to step 2406. As long as the determined thermal gain (ThermalGain) for the electrode 112 equals or exceeds the threshold thermal gain of twenty degrees Celsius per watt (20°C/W), the power limit remains at the original setting (i.e., eight watts). If the determined thermal gain is less than the threshold thermal gain, the power limit is reduced according to equation (18) at step 2408. Moreover, throughout the ablation procedure, the determined thermal gain may be communicated to the operator of the ablation system 100 as described above.

[00114] Figures 15A, 15B, and 15C and Figures 16A, 16B, and 16C graphically illustrate computer simulations of a portion of a single sixty second long ablation procedure using the adaptive power limiting described herein. Figures 15A, 15B, and 15C are the graphical results of a simulated ablation procedure without use of the adaptive power limiting, while Figures 16A, 16B, and 16C are the graphical results of a simulated ablation procedure using the adaptive power limiting. For both of these examples, the maximum power limit is eight watts. Beginning at about five seconds into the ablation procedure, the temperature set-point ramps up from the ambient temperature (about forty degrees Celsius, 40°C) to the ablation set-point of seventy degrees Celsius (70°C). Contact between the electrode 112 and the artery wall decreases sharply about twenty seconds into the ablation procedure. These simulations approximate an arterial spasm decreasing contact of the electrode 112 with the artery wall for about five seconds.

[00115] In particular, Figure 15A presents the electrode temperature set-point 1500 and the measured electrode temperature 1502. Figure 15B shows the power 1504 delivered to the electrode 112, and Figure 15C is a graph of the thermal gain 1506 of the electrode 112. At approximately twenty seconds, the thermal gain 1506 drops rapidly from forty degrees Celsius per watt (40°C/W) to five degrees

Celsius per watt ($5^{\circ}\text{C}/\text{W}$) and the temperature 1502 decreases below the temperature set-point 1500. The controller 218 attempts to increase the electrode temperature 1502 back to the set-point 1500 by supplying additional power 1504 to the electrode 112. Because of the decreased arterial contact (and accordingly decreased thermal gain 1506), the additional power is unable to increase the temperature 1502 back to the set-point 1500. The power 1504 applied to the electrode 112 thus increases, without significantly increasing the temperature 1502, until the eight watt power limit is reached at about twenty-two seconds. When the thermal gain returns to forty degrees Celsius per watt ($40^{\circ}\text{C}/\text{W}$) at about twenty-five seconds, the electrode temperature 1502 spikes up above the temperature set-point due to the large amount of power being applied to the electrode 112.

[00116] Turning now to the simulation illustrated by Figures 16A, 16B, and 16C including the adaptive power limiting, Figure 16A presents the temperature set-point 1600 and the electrode temperature 1602. Figure 16B shows the power 1604 delivered to the electrode 112 and the power limit 1605. Figure 16C graphs the actual thermal gain 1606 of the electrode 112 and the determined thermal gain 1608. At approximately twenty seconds, the actual thermal gain 1606 drops rapidly from $40^{\circ}\text{C}/\text{W}$ to $5^{\circ}\text{C}/\text{W}$ and the temperature 1602 decreases below the temperature set-point 1600. The determined thermal gain 1608 decreases slower than the actual thermal gain 1606. While the determined thermal gain 1608 remains above a thermal gain threshold of $20^{\circ}\text{C}/\text{W}$, the controller 218 attempts to increase the electrode temperature 1602 back to the set-point 1600 by supplying additional power 1604 to the electrode 112. Because of the decreased arterial contact (and accordingly decreased thermal gain 1606), the additional power is unable to increase the temperature 1602 back to the set-point 1600. Once the determined thermal gain decreases below $20^{\circ}\text{C}/\text{W}$, the controller 218 decreases the power limit 1605 proportional to the difference between the determined thermal gain 1608 and the threshold. The power 1604 applied to the electrode 112 is limited to the reduced power limit 1605, and the electrode temperature 1602 continues to decrease. When the actual thermal gain returns to $40^{\circ}\text{C}/\text{W}$ at about twenty-five seconds, the electrode temperature 1602 and the determined thermal gain 1608 begin to increase gradually.

As the determined thermal gain 1608 increases, the reduced power limit 1605 increases. Once the determined thermal gain 1608 is above the 20°C/W threshold, the power limit 1605 has returned to the original eight watts. As can be seen, the adaptive power limiting inhibits a spike in the electrode temperature 1602 above the temperature set-point 1600, as well as inhibiting application of significant power to the electrode 112 when it is not in good contact with the artery wall.

[00117] Figure 17 is a graphical presentation of the results of a bench-top test of a single sixty second ablation procedure using the ablation system 100 including the adaptive power limiting described herein. Figure 17 presents the temperature set-point 1700, the electrode temperature 1702, and the electrode power 1704 versus time. The time scale is in one hundred millisecond (100ms) increments. The maximum power limit in this test is eight watts and the startup conditions are an electrode temperature of sixty-five degrees Celsius (65°C) or twelve joules (12J) of energy delivered. At about fifteen seconds into the procedure, the temperature set-point begins to ramp up from ambient temperature to seventy degrees Celsius (70°C). Four spasms, which cause the thermal gain to drop rapidly, are simulated at times t1, t2, t3, and t4. During the first spasm, neither startup condition has been met and the adaptive power limiting is not applied. The power 1704 increases rapidly until the power limit of eight watts is reached. The startup condition is met before the second, third and fourth simulated spasms. As can be seen, the reduced power limit is applied to prevent the power 1704 from increasing during the spasms and preventing the temperature 1702 from spiking up following the spasms.

[00118] Figures 18-20 graphically present the results of three separate sixty second ablation procedure animal tests of the system 100 with the adaptive power limiting. Each figure represents the measurements of a single electrode 112 during a different test. The time scale is in one hundred millisecond (100ms) increments. The maximum power limit in this test is eight watts and the startup conditions are an electrode temperature of sixty-five degrees Celsius (65°C) or twelve joules (12J) of energy delivered. The thermal gain threshold is twenty degrees Celsius per watt (20°C/W), and the electrode temperature set-point (not shown) begins to ramp up to seventy degrees Celsius (70°C) at about ten seconds into

the procedure. All three figures present the electrode temperature 1802, the electrode power 1804, the power limit 1805, the thermal gain 1808 of the electrode 112, and the energy 1810 dissipated through the electrode 112 as a function of time.

[00119] In Figure 18, the startup condition is met and the adaptive power limit is activated at about time t1. At time t1, the thermal gain 1808 is slightly less than the threshold thermal gain of 20°C/W and the power limit 1805 decreases, but the thermal gain 1808 returns above 20°C/W before the power limit 1805 decreases enough to impact operation of the ablation system 100. Throughout the ablation procedure shown in Figure 18, the temperature 1802 remains fairly constant at the temperature set-point of seventy degrees Celsius (70°C) after it is ramped up to that temperature.

[00120] In Figure 19, the startup condition is met and the adaptive power limit is activated at about time t1. At time t1, the thermal gain 1808 is less than the threshold thermal gain of 20°C/W and the power limit 1805 decreases. The power 1804 delivered to the electrode 112 is limited to the reduced power limit 1805. As the thermal gain 1808 varies after time t1, the power limit 1805 is correspondingly varied. After about time t2, the thermal gain, although varying, remains close to the threshold 20°C/W and the power limit 1805 remains close to the maximum power limit of eight watts. Throughout the ablation procedure shown in Figure 19, the temperature 1802 remains fairly constant at the temperature set-point of seventy degrees Celsius (70°C) after about time t2.

[00121] In Figure 20, the startup condition is met and the adaptive power limit is activated at about time t1. In this test, there is poor contact between the electrode 112 and the artery wall. At time t1, the thermal gain 1808 is less than the threshold thermal gain of 20°C/W and the power limit 1805 decreases. The power 1804 delivered to the electrode 112 is limited to the reduced power limit 1805. As the thermal gain 1808 varies after time t1, the power limit 1805 is correspondingly varied. After time t1, the thermal gain 1808 remains well below the threshold 20°C/W and the power limit 1805 remains relatively low (around four watts) and limits the power applied to the electrode 112 for the remainder of the period of the ablation procedure.

In this test, the temperature 1802 is limited by the low thermal gain 1808 and the power limit 1805, fluctuating between about fifty-five and sixty-five degrees Celsius (55°C -65°C) after time t1.

[00122] With reference now to Figures 21-23, at the beginning of an ablation procedure, the system 100 (and more specifically the controller 218) gradually increases the temperature at each electrode 112 until the temperature reaches a temperature set-point. Ramping up the temperature at the electrodes 112 allows lesion formation and desensitizes the artery at a lower temperature before the full ablation temperature is reached, which may reduce arterial spasms. Figure 21 shows the temperature 2100 of one electrode 112 for a sixty second ablation procedure. The temperature 2100 begins at about forty degrees Celsius (40°C, i.e., around body temperature). At time t1, controller 218 selectively couples the electrode 112 to the generator output to increase the temperature 2100 at a predetermined rate (in degrees Celsius per second) of increase. At time t2, the temperature 2100 has reached the temperature set-point of seventy degrees Celsius (70°C) and controller 218 selectively couples the electrode 112 to the generator output to maintain the temperature 2100 at the temperature set-point. The predetermined rate of increase applied to each electrode 112 may be the same or different.

[00123] Moreover, the beginning of the temperature increase for each electrode 112 may occur concurrently, or at different times. For example, Figure 22 shows the temperatures 2200, 2202, 2204, and 2206 of four electrodes E1, E2, E3, and E4 (collectively referred to as electrodes 112). The beginning of the temperature increase for each electrode 112 is staggered by a delay period. Thus, the temperature 2202 on electrode E2 begins to increase after the delay period 2208 following the beginning of the increase of the temperature 2204 on electrode E1. Similarly, the temperature 2204 of electrode E3 begins to increase following the delay period 2210 and the temperature 2206 on electrode E4 begins its increase after the delay period 2212.

[00124] In some embodiments, the temperature of the electrodes 112 is increased in more than one stage. Figure 23 graphically presents an example of a

two stage ramp up of the electrode temperature 2300 for an electrode 112. It is also understood that more than two stages may be used. At time t_1 , the controller 218 begins to increase the temperature of the electrode 112 at a first predetermined rate. When the temperature 2300 reaches a first temperature set-point SP1, the controller 218 selectively couples the electrode 112 to the generator to maintain the temperature at the set-point SP1 for a dwell period (from time t_2 to time t_3). Following the dwell period, the controller 218 selectively couples the electrode 112 to the generator to increase the temperature 2300 at a second predetermined rate to a second temperature set-point SP2. The controller 218 then maintains the temperature 2300 at the second temperature set-point SP2 for the remainder of the ablation procedure. The second predetermined rate is not the same as the first predetermined rate. Specifically, the second predetermined rate is slower than the first predetermined rate (i.e., fewer degrees Celsius per second). In an exemplary embodiment, the first rate is four degrees Celsius per second ($4^{\circ}\text{C}/\text{second}$), the first temperature set-point is sixty five degrees Celsius (65°C), the second rate is one degree Celsius per second ($1^{\circ}\text{C}/\text{second}$), and the second temperature set-point is seventy degrees Celsius (70°C). In other embodiments, any other suitable rate may be used for the first and second rates, including the same rate. Moreover, in some embodiments, the dwell period is omitted (or has a value of zero seconds).

[00125] At various times during operation, the controller 128 samples the output voltage of the generator 102. The output voltage of the generator 102 is the output of the RF output circuit 130 and is a generally sinusoidal, time invariant output signal having a known output frequency. In the illustrated embodiment, the output signal has a frequency of 480 kilohertz (kHz). The illustrated controller 128 is capable of sampling the output signal at a rate of 1.6 megasamples per second (MS/s). Accordingly, the controller 128 is able to acquire approximately three samples of the output signal during one period of the output cycle. To improve the resolution of the sampling of the output voltage, the controller 128 samples the output voltage at different phases throughout many periods of the output signal and combines the multi-period samples into a representation of a single period of the output signal.

[00126] In general, the sampling method employed by the controller 128 involves sampling a time invariant output signal at a sampling rate that results in the samples of the output signal in any period of the output signal being acquired at different phases of the output signal than the samples acquired during the immediately previous period. The shift in the phase of the samples is fixed by the frequency of the output signal and the sample rate. Specifically, the sample shift in time is defined by:

$$\text{sample shift} = (n * \text{sample period}) - \text{output period} \quad (19)$$

where the sample period is the period of the sampling, the output period is the period of the output signal, and n is the smallest integer value that results in a sample shift greater than zero. In order for the sampling method described herein to be used, the sample shift cannot equal zero. In other words the output period cannot be evenly divisible by the sample period. If the sample shift equals zero, the output period or the sample period can be adjusted to produce a nonzero sample shift. The amount of the phase shift may be found by:

$$\text{phase shift} = \frac{\text{sample shift}}{\text{output period}} * 360^\circ \quad (20)$$

Because the frequency of the output signal and the sampling rate are fixed, the phase shift will advance the phase of the samples throughout a number of periods until the samples during a period of the output signal substantially align with the phases sampled in the first period sampled. The number of samples (S) that are acquired before this occurs is the smallest integer S that satisfies:

$$\text{remainder of} \left(S * \frac{\text{phase shift}}{360^\circ} \right) = 0 \quad (21)$$

The number of output signal periods that are sampled before the sample phases realign with the first period sample phases, sometimes referred to herein as a superperiod, may be found by dividing the number of samples by the number of samples that may be acquired in one period of the output signal, i.e. n-1 samples. The resolution of the sampling is:

$$resolution = \frac{S}{360^\circ} \quad (22)$$

The samples acquired during such a superperiod are combined as a function of phase to produce a representation of a single period of the output signal.

Sampling Example

[00127] This method for sampling the output signal will be further illustrated with reference to Figures 13 and 14. For this example, the output signal has a period of 2.1 microseconds (μs), corresponding to a frequency of 476.19048 kHz. The controller 128 samples the output signal at a rate of 1.5385 megasamples per second (MS/s), giving a sample period of 0.65 μs . Using equation (19), four is the smallest integer value that results in a sample shift greater than zero. Because n equals four, the sample shift is 0.5 μs . Plugging the sample shift into equation 3 results in a phase shift of about 85.7° . When S equals 42, equation (21) is satisfied. Thus, in this example, 42 samples will be acquired during a superperiod, which will include 14 output periods, and combined to represent one period of the output signal, with a resolution of 8.57° . Figure 13 is a graphical representation of the output signal waveform 1300. The diamonds on the output signal waveform 1300 indicate samples 1302 of the output signal by controller 128. In Figure 14, the samples 1302 are graphed as a function of the output signal phase of the samples 1302 producing a representation of a single period of the output signal waveform 1300. Each sample is spaced from its neighbor samples by 8.57° (the sampling resolution). This provides a much more accurate representation of a period of the output signal than would be provided by the three samples separated from each other by about 111° that are acquired during a single phase of the output signal.

[00128] Although described herein with reference to the output signal of the ablation generator 102, this sampling technique may be used to sample any suitable signal in any suitable apparatus. The signal to be sampled must have a fixed and known frequency. The signal needs to be substantially invariant, i.e., each period of the signal should be the same as each other period of the signal. The more

invariant the signal, the more accurate the combined representation will be. The signal does not necessarily need to be invariant over multiple superperiods.

[00129] In an embodiment, a multi-electrode ablation system generally comprises a power supply configured to be coupled to a plurality of electrodes for delivering power to the electrodes. A controller of the system is operable to: compare a measured temperature at each electrode to a desired temperature to thereby define a temperature difference for each electrode; determine, based on said temperature difference, a desired power for each electrode; compare the desired power of one of the electrodes to an actual power delivered to said one of the electrodes to define a power difference; and adjust the actual power delivered by the power supply to said one of the electrodes based on said power difference.

[00130] In an embodiment of the system, adjusting the actual power delivered to said one of the electrodes generally comprises determining based on the desired power a voltage to be delivered to said one of the electrodes, and delivering said voltage from the power supply to said one of the electrodes for a first time period. In another embodiment of the system the controller is further operable to deliver the determined voltage from the power supply to all of the electrodes. In another embodiment of the system the controller is further operable to: determine, based on the desired power for each electrode, a desired energy to be dissipated by each electrode; determine, for each electrode other than said one of the electrodes, based on the actual power delivered to said one of the electrodes and the desired energy to be dissipated by each respective other electrode, a respective second time period during which the voltage is delivered to each of the other electrodes, the respective second time period being no greater than the first time period during which the voltage is delivered to said one of the electrodes. In another embodiment of the system each respective second time period is less than the first time period. In another embodiment the controller is further configured to decouple the power supply from each of the other electrodes upon expiration of the respective second time period.

[00131] In an embodiment of the system, comparing the desired power of one of the electrodes to an actual power delivered to said one of the electrodes to define a power difference generally comprises determining which of the electrodes has the greatest desired power and comparing the desired power of the electrode having the greatest desired power to an actual power delivered to said electrode having the greatest desired power to define the power difference. In another embodiment of the system the power supply comprises a buck regulator. In another embodiment the system generally comprises a plurality of temperature sensors, each associated with a respective one of the electrodes and being coupled to the controller for providing the measured temperature at each electrode to the controller.

[00132] In an embodiment of a method of operating a multi-electrode ablation system, the method generally comprises comparing a measured temperature at each electrode to a desired temperature to thereby define a temperature difference for each electrode; determining, based on said temperature difference, a desired power to be delivered to each electrode; comparing the desired power to be delivered to one of the electrodes to an actual power delivered to said one of the electrodes to define a power difference; and adjusting, based on the power difference, the actual power delivered to said one of the electrodes.

[00133] In another embodiment of the method, adjusting the actual power delivered to said one of the electrodes comprises determining based on the desired power a voltage to be delivered to said one of the electrodes, and delivering said voltage to said one of the electrodes for a first time period.

[00134] In another embodiment the method further comprises delivering said voltage to each electrode other than said one of the electrodes.

[00135] In another embodiment the method further comprises determining, based on the desired power for each electrode, a desired energy to be dissipated by each electrode; and determining, for each electrode other than said one of the electrodes, based on the actual power delivered to said one of the electrodes and the desired energy to be dissipated by each respective other electrode, a respective

second time period during which the voltage is delivered to each of the other electrodes, the respective second time period being no greater than the first time period during which the voltage is delivered to said one of the electrodes. In another embodiment each respective second time period is less than the first time period. In another embodiment the method further comprises terminating the delivery of voltage to each of the other electrodes as the respective second time period associated with each of the other electrodes expires.

[00136] In another embodiment of the method, comparing the desired power of one of the electrodes to an actual power delivered to said one of the electrodes to define a power difference comprises determining which of the electrodes has the greatest desired power and comparing the desired power of the electrode having the greatest desired power to an actual power delivered to said electrode having the greatest desired power to define the power difference.

[00137] In an embodiment, a controller for a multi-electrode ablation system having a plurality of electrodes and a power supply configured to be coupled to the plurality of electrodes generally comprises a processor; and a memory device. The memory device includes instructions that, when executed by the processor, cause the processor to: determine a desired power to be supplied to each electrode at least in part as a function of a temperature at each respective electrode; and determine an actual voltage to be supplied to each electrode at least in part as a function of the desired power to be supplied to at least one of the electrodes.

[00138] In another embodiment of the controller, the processor is caused to determine an actual voltage to be supplied to each electrode at least in part as a function of the difference between the desired power to be supplied to at least one of the electrodes and an actual power supplied to the at least one of the electrodes.

[00139] In another embodiment of the controller, the processor is caused to determine the desired power to be supplied to each electrode at least in part as a function of the difference between a desired temperature and a measured temperature at each respective electrode. In another embodiment of the controller, the

memory device includes instructions that, when executed by the processor, deliver the determined actual voltage to be supplied to one of the electrodes from the power supply to said one of the electrodes for a first time period, determine, based on the desired power for each electrode, a desired energy to be dissipated by each electrode; and determine, for each electrode other than said one of the electrodes, based at least on the actual voltage delivered to said one of the electrodes and the desired energy to be dissipated by each respective other electrode, a respective second time period during which the voltage is delivered to each of the other electrodes, the respective second time period being no greater than the first time period during which the voltage is delivered to said one of the electrodes.

[00140] In an embodiment, a multi-electrode ablation system generally comprises a power supply configured to be coupled to a plurality of electrodes; and a controller coupled to the power supply, the controller configured to: determine an amount of energy to be dissipated through each electrode of the plurality of electrodes during an output cycle, the electrode having the greatest energy to be dissipated defining a highest demand electrode of the system; determine an output voltage of the power supply that will provide the determined energy dissipation through the highest demand electrode; couple the determined output voltage from the power supply to all of the electrodes; and maintain coupling of the determined output voltage to the highest demand electrode until an end of the output cycle.

[00141] In another embodiment of the system, the power supply comprises a buck regulator.

[00142] In another embodiment of the system, the controller is further configured to decouple the output voltage from each electrode other than the highest demand electrode when the energy dissipated through each said electrode substantially equals the determined amount of energy to be dissipated through said electrode.

[00143] In another embodiment of the system, the controller is configured to determine the amount of energy to be dissipated through each electrode

based at least in part on a difference between a measured temperature at each electrode and a desired temperature at each electrode. In another embodiment, the system further comprises a plurality of temperature sensors, each temperature sensor of the plurality of temperature sensors coupled to a different electrode of the plurality of electrodes. In another embodiment the system comprises a multiplexer coupled to the controller, each electrode of the plurality of electrodes coupled to the controller via the multiplexer. In another embodiment of the system, the controller is configured to sample a temperature from only one of the temperature sensors via the multiplexer during the output cycle. In another embodiment of the system, the controller is configured to sample a temperature from a different one of the temperature sensors via the multiplexer during a subsequent output cycle.

[00144] In another embodiment, the system further comprises a catheter, and wherein the plurality of electrodes are carried by the catheter. In another embodiment of the system, the catheter is a renal ablation catheter.

[00145] In an embodiment of a method of operating a multi-electrode ablation system comprising a plurality of electrodes and a power supply configured to be coupled to the plurality of electrodes, the method generally comprises: determining an amount of energy to be dissipated through each electrode of the plurality of electrodes in an output cycle, the electrode having the greatest energy to be dissipated defining a highest demand electrode of the system; determining an output voltage of the power supply that will provide the determined energy dissipation through the highest demand electrode; coupling the determined output voltage from the power supply to all of the electrodes; and maintaining coupling of the determined output voltage to the highest demand electrode until an end of the output cycle.

[00146] In another embodiment, the method further comprises decoupling the output voltage from each electrode of the plurality of electrodes other than the highest demand electrode when the energy dissipated through each said electrode substantially equals the determined amount of energy to be dissipated through said electrode.

[00147] In another embodiment of the method, determining an amount of energy to be dissipated through each electrode comprises determining an amount of energy to be dissipated through each electrode based at least in part on a difference between a measured temperature at each electrode and a desired temperature at each electrode. In another embodiment, the method further comprises measuring a temperature at each electrode by sampling a plurality of temperature sensors coupled to the plurality of electrodes, wherein each temperature sensor is coupled to a respective one of the electrodes. In another embodiment of the method, measuring a temperature at each electrode comprises measuring a temperature at each electrode via a multiplexer coupled between the controller and the plurality of temperature sensors. In another embodiment of the method, measuring a temperature at each electrode comprises sampling a temperature from only one of the temperatures sensors via the multiplexer during the output cycle, and sampling a temperature from a different one of the temperatures sensors via the multiplexer during a next output cycle.

[00148] In another embodiment, the method further comprises decoupling the output voltage from each electrode of the plurality of electrodes other than the highest demand electrode at least in part as a function of a time period within the output cycle during which the actual voltage is supplied to the other electrodes, said time period being less than a time period during which the actual voltage is supplied to the highest demand electrode within the output cycle.

[00149] In an embodiment, a controller for a multi-electrode ablation system including a plurality of electrodes and a power supply configured to be coupled to the plurality of electrodes generally comprises a processor and a memory device. The memory device includes instructions that, when executed by the processor, cause the processor to: determine an amount of energy to be dissipated through each electrode of the plurality of electrodes in an output cycle, the electrode having the greatest energy to be dissipated defining a highest demand electrode of the system; determine an output voltage of the power supply that will provide the determined energy dissipation through the highest demand electrode; couple the determined output voltage from the power supply to all of the plurality of electrodes;

and maintain coupling of the determined output voltage to the highest demand electrode until an end of the output cycle.

[00150] In another embodiment of the controller, the memory device includes instructions that, when executed by the processor, cause the processor to decouple the output voltage from each electrode of the plurality of electrodes other than the highest demand electrode when the energy dissipated through each said electrode substantially equals the determined amount of energy to be dissipated through said electrode.

[00151] In another embodiment of the controller, the memory device includes instructions that, when executed by the processor, cause the processor to determine the amount of energy to be dissipated through each electrode based at least in part on a difference between a measured temperature at each electrode and a desired temperature at each electrode. In another embodiment of the controller, the memory device includes instructions that, when executed by the processor, cause the processor to measure a temperature at each electrode by sampling a plurality of temperature sensors coupled to the plurality of electrodes, wherein each sensor of the plurality of temperature sensors is coupled to a respective one of the electrodes. In another embodiment of the controller, the memory device includes instructions that, when executed by the processor, cause the processor to sample a temperature from a first sensor of the plurality of temperature sensors via a multiplexer coupled between the plurality of sensors and the controller during the output cycle. In another embodiment of the controller, the memory device includes instructions that, when executed by the processor, cause the processor to sample a temperature from a different sensor of the plurality of temperature sensors via the multiplexer during a next output cycle.

[00152] In an embodiment of a method of operating a multi-electrode ablation system comprising a plurality of electrodes and a power supply configured to be coupled to the plurality of electrodes, the method generally comprises: determining, for each electrode of the plurality of electrodes, a desired amount of energy to be dissipated through each electrode of the plurality of electrode

during an output cycle; coupling an output voltage of the power supply to all electrodes of the plurality of electrodes; determining an amount of energy dissipated through each electrode during the output cycle; and until a last electrode remains coupled to the output voltage, decoupling each electrode from the output voltage of the power supply at a time when the amount of energy dissipated through said electrode substantially equals the determined amount of energy to be dissipated through said electrode during the output cycle.

[00153] In another embodiment, the method further comprises determining a current flowing through each electrode of the plurality of electrodes after coupling the output voltage to all electrodes. In another embodiment, the method further comprises determining a current that will be flowing through each electrode still coupled to the output voltage after decoupling of an electrode from the output voltage.

[00154] In another embodiment, the method further comprises decoupling the last electrode from the output voltage at an end of the output cycle.

[00155] In another embodiment of the method, the output cycle includes a measurement period during which fewer than all of the plurality of electrodes are concurrently coupled to the output voltage and an output period beginning when all of the electrodes are concurrently coupled to the output voltage, and wherein determining an amount of energy dissipated through each electrode during the output cycle comprises determining an amount of energy dissipated through each electrode during the measurement period and the output period. In another embodiment of the method, the measurement period comprises a plurality of measurement sub-periods, and wherein the method further comprises coupling the output voltage to each electrode of the plurality of electrodes during a different measurement sub-period. In another embodiment, the method further comprises coupling at least two electrodes of the plurality of electrodes to the output voltage during at least one of the measurement sub-periods. In another embodiment, the method further comprises measuring the output voltage and a current through each electrode during the measurement sub-period in which said electrode is coupled to the

output voltage. In another embodiment, the method further comprises measuring the output voltage and a current through the at least two electrodes during the measurement sub-period in which said at least two electrodes are coupled to the output voltage.

[00156] In an embodiment, a multi-electrode ablation system generally comprises a power supply configured to be coupled to a plurality of electrodes and a controller coupled to the power supply. The controller is configured to: determine, for each electrode of the plurality of electrodes, an amount of energy to be dissipated through each electrode of the plurality of electrode during an output cycle; couple an output voltage of the power supply to all electrodes of the plurality of electrodes; determine an amount of energy dissipated through each electrode during the output cycle; and until a last electrode remains coupled to the output voltage, sequentially decouple each electrode from the output voltage of the power supply at a respective time when the amount of energy dissipated through said electrode substantially equals the determined amount of energy to be dissipated through said electrode during the output cycle.

[00157] In another embodiment of the system, the controller is further configured to determine a current flowing through each electrode of the plurality of electrodes after coupling the output voltage to all electrodes. In another embodiment of the system the controller is further configured to determine a current that will be flowing through each electrode still coupled to the output voltage after each decoupling of an electrode from the output voltage.

[00158] In another embodiment of the system, the controller is further configured to decouple the last electrode from the output voltage at an end of the output cycle.

[00159] In another embodiment of the system, the output cycle includes a measurement period during which fewer than all of the plurality of electrodes are concurrently coupled to the output voltage and an output period beginning when all of the electrodes are concurrently coupled to the output voltage,

and wherein the controller is further configured to determine an amount of energy dissipated through each electrode during the output cycle by determining an amount of energy dissipated through each electrode during the measurement period and the output period. In another embodiment of the system, the measurement period comprises a plurality of measurement sub-periods, and wherein the controller is further configured to couple the output voltage to each electrode of the plurality of electrodes during a different measurement sub-period. In another embodiment of the system, the controller is further configured to couple at least two electrodes of the plurality of electrodes to the output voltage during at least one of the measurement sub-periods. In another embodiment of the system, the controller is further configured to measure the output voltage and a current through each electrode during the measurement sub-period in which said electrode is coupled to the output voltage. In another embodiment of the system, the controller is further configured to measure the output voltage and a current through the at least two electrodes during the measurement sub-period in which said at least two electrodes are coupled to the output voltage.

[00160] In an embodiment of a method of determining a common path impedance in a multi-electrode ablation system using a single current sensor in a common return path, the method generally comprises: measuring a first current through a common return path for the system when a first voltage is applied to a first electrode; measuring a second current through the common return path when a second voltage is applied to a second electrode; measuring a third current through the common return path when a third voltage is applied concurrently to the first electrode and the second electrode; and determining a common path impedance based at least in part on the first voltage and the first current, the second voltage and the second current, and the third voltage and the third current.

[00161] In another embodiment of the method, the first voltage, the second voltage, and the third voltage are substantially equal.

[00162] In another embodiment, the method further comprises: coupling the first voltage to the first electrode with the second voltage decoupled from

the second electrode; coupling the second voltage to the second electrode with the first voltage decoupled from the first electrode; and coupling the third voltage concurrently to the first electrode and the second electrode.

[00163] In another embodiment, the method further comprises: measuring the first voltage with a first voltage sensor; measuring the second voltage with a second voltage sensor; measuring the third voltage with the first voltage sensor and the second voltage sensor.

[00164] In another embodiment of the method, determining a common path impedance includes determining a first branch resistance based on the first voltage and the first current, determining a second branch resistance based on the second voltage and the second current, and determining a combination branch resistance based on the third voltage and the third current. In another embodiment of the method, determining a common path impedance based on the first voltage and the first current, the second voltage and the second current, and the third voltage and the third current comprises determining a common path resistance based on the first branch resistance, the second branch resistance, and the combination branch resistance.

[00165] In an embodiment, a multi-electrode ablation system generally comprises a power supply configured to be coupled to a plurality of electrodes by a common return path, and a controller. The controller is configured to: measure a first current through the common return path when a first voltage is applied by the power supply to a first electrode of the plurality of electrodes; measure a second current through the common return path when a second voltage is applied by the power supply to a second electrode of the plurality of electrodes; measure a third current through the common return path when a third voltage is applied by the power supply concurrently to the first electrode and the second electrode; and determine a common path impedance based at least in part on the first voltage and the first current, the second voltage and the second current, and the third voltage and the third current.

[00166] In another embodiment of the system, the first voltage, the second voltage, and the third voltage are substantially equal. In another embodiment the system further comprises a current sensor communicatively coupled to the controller and configured to detect current through the common return path.

[00167] In another embodiment of the system, the controller is further configured to couple voltage from the power supply to the plurality of electrodes based at least in part on the determined common path impedance.

[00168] In another embodiment of the system, the controller is further configured to determine the common path impedance in part by determining a first branch resistance based on the first voltage and the first current, determining a second branch resistance based on the second voltage and the second current, and determining a combination branch resistance based on the third voltage and the third current.

[00169] In an embodiment, a controller for a multi-electrode ablation system including a plurality of electrodes and a power supply, the plurality of electrodes coupled to the power supply by a common return path, generally comprises a processor and a memory device. The memory device includes instructions that, when executed by the processor, cause the processor to: measure a first current through the common return path when a first voltage is applied to a first electrode of the plurality of electrodes; measure a second current through the common return path when a second voltage is applied to a second electrode of the plurality of electrodes; measure a third current through the common return path when a third voltage is applied concurrently to the first electrode and the second electrode; and determine a common path impedance based on the first voltage and the first current, the second voltage and the second current, and the third voltage and the third current.

[00170] In another embodiment of the controller, the memory device further includes instructions that, when executed by the processor, cause the processor to couple voltage from a power supply to the plurality of electrodes based at least in part on the determined common path impedance.

[00171] In another embodiment of the controller, the memory device further includes instructions that, when executed by the processor, cause the processor to determine the common path impedance in part by determining a first branch resistance based on the first voltage and the first current, determining a second branch resistance based on the second voltage and the second current, and determining a combination branch resistance based on the third voltage and the third current.

[00172] In an embodiment, a multi-electrode ablation system generally comprises a plurality of electrodes; a return electrode; a power supply configured to be coupled to the plurality of electrodes and the return electrode, wherein a conduction path between the plurality of electrodes and the return electrode defines a common return path of the system; and a controller coupled to the power supply, the controller configured to: couple an output voltage of the power supply to the plurality of electrodes; determine a therapeutic resistance associated with each electrode of the plurality of electrodes and a resistance of the common return path; and generate a notification when the determined resistance of the common return path exceeds a first threshold value.

[00173] In another embodiment of the system, the notification is a visual notification. In another embodiment of the system, the visual notification is a unitless visual notification.

[00174] In another embodiment of the system, the controller is further configured to disable the plurality of electrodes when the determined resistance of the common path exceeds the first threshold value.

[00175] In another embodiment of the system, the controller is further configured to disable the plurality of electrodes when the determined resistance of the common path exceeds a second threshold value greater than the first threshold value.

[00176] In another embodiment of the system, the notification is a notification to couple an additional return electrode to the power supply.

[00177] In an embodiment of a method of operating a multi-electrode ablation system having a plurality of electrodes, a return electrode, and a power supply configured to be coupled to the plurality of electrodes and the return electrode, the method generally comprises: coupling an output voltage of the power supply to the plurality of electrodes; determining a therapeutic resistance associated with each electrode of the plurality of electrodes and a resistance of a common return path defined between the plurality of electrodes and the return electrode; generating a notification when the determined resistance of the common path exceeds a first threshold value.

[00178] In another embodiment of the method, generating a notification comprises generating a visual notification. In another embodiment of the method, generating a visual notification comprises generating a unitless visual notification.

[00179] In another embodiment, the method further comprises disabling the plurality of electrodes when the determined resistance of the common path exceeds the first threshold value.

[00180] In another embodiment, the method further comprises disabling the plurality of electrodes when the determined resistance of the common path exceeds a second threshold value greater than the first threshold value.

[00181] In another embodiment of the method, generating a notification comprises generating a notification to couple an additional return electrode to the power supply.

[00182] In an embodiment, a multi-electrode ablation system generally comprises a power supply configured to be coupled to a plurality of electrodes; and a controller coupled to the power supply. The controller is configured to: couple an output voltage of the power supply to the plurality of electrodes; for each electrode of the plurality of electrodes, measure a temperature associated with said electrode; and determine a thermal gain of each electrode of the plurality of electrodes.

[00183] In another embodiment of the system, the controller is further configured to generate a notification for each electrode corresponding to the determined thermal gain for said electrode. In another embodiment of the system, the notification is a visual notification. In another embodiment of the system, the visual notification is a unitless visual notification.

[00184] In another embodiment, the system further comprises a display device, and the visual notification is a display of the determined thermal gain of each electrode on the display device.

[00185] In another embodiment of the system, the controller is configured to compare the determined thermal gain of each electrode to a threshold thermal gain. In another embodiment of the system, the controller is configured to disable each electrode of the plurality of electrodes for which the determined thermal gain exceeds the threshold thermal gain. In another embodiment of the system, the plurality of electrodes are coupled to the power supply by a common return path, and wherein the controller is configured to determine a therapeutic resistance associated with each electrode of the plurality of electrodes and a resistance of the common return path. In another embodiment of the system, the controller is configured to determine the power applied to the therapeutic resistance associated with each electrode and determine the thermal gain of each electrode as a function of the power dissipated in the therapeutic resistance associated with said electrode and the measured temperature associated with said electrode.

[00186] In another embodiment of the system, the controller is configured to continuously determine the thermal gain of each electrode and calculate a rate of change of the thermal gain for each electrode. In another embodiment of the system, the controller is configured to disable each electrode for which the calculated rate of change of the thermal gain exceeds a rate of change threshold.

[00187] In an embodiment of a method of operating a multi-electrode ablation system having a plurality of electrodes and a power supply configured to be coupled to the plurality of electrodes, the method generally

comprises: coupling an output voltage of the power supply to the plurality of electrodes; for each electrode of the plurality of electrodes, measuring a temperature associated with said electrode; and determining a thermal gain of each electrode of the plurality of electrodes.

[00188] In another embodiment, the method further comprises generating a notification for each electrode corresponding to the determined thermal gain for said electrode.

[00189] In another embodiment of the method, generating a notification comprises generating a visual notification. In another embodiment of the method, generating a visual notification comprises generating a unitless visual notification. In another embodiment of the method, the system includes a display device, and generating a visual notification comprises displaying the determined thermal gain of each electrode on the display device. In another embodiment, the method further comprises comparing the determined thermal gain of each electrode to a threshold thermal gain. In another embodiment, the method further comprises disabling each electrode of the plurality of electrodes for which the determined thermal gain exceeds the threshold thermal gain.

[00190] In another embodiment of the method, the plurality of electrodes are coupled to the power supply by a common return path, and wherein the method further comprises determining a therapeutic resistance associate with each electrode of the plurality of electrodes and a resistance of the common return path. In another embodiment, the method further comprises determining the power applied to the therapeutic resistance associated with each electrode and determine the thermal gain of each electrode as a function of the power dissipated in the therapeutic resistance associate with said electrode and the measured temperature associated with said electrode.

[00191] In another embodiment of the method, determining a thermal gain comprises continuously determining the thermal gain of each electrode and calculating a rate of change of the thermal gain for each electrode. In another

embodiment, the method further comprises disabling each electrode for which the calculated rate of change of the thermal gain exceeds a rate of change threshold.

[00192] In an embodiment of a method of sampling a periodic, time invariant signal having a known frequency, the method generally comprises: sampling the signal at a substantially fixed frequency during a first plurality of periods of the signal to collect a plurality of samples of the signal, wherein each sample includes a phase of the signal and an amplitude of the signal, wherein the substantially fixed frequency is selected to collect one or more samples during each period of the signal at a different phase of the signal than samples collected during an immediately prior period of the signal; and combining the plurality of samples collected over the first plurality of periods of the signal as a function of the phase of the signal to produce a representation of a single period of the signal.

[00193] In another embodiment of the method, a first collected sample from during the first plurality of periods has a first phase, and combining the plurality of samples collected over the first plurality of periods of the signal comprises combining the plurality of samples collected over a plurality of periods of the signal that ends with a period prior to a second plurality of periods in which the phase of the signal in a first collected sample of the second plurality of periods substantially equals the first phase in the first collected sample of the first plurality of periods.

[00194] In an embodiment, a controller generally comprises a processor and a memory device. The memory device includes instructions that, when executed by the processor, cause the processor to: sample a periodic, time invariant signal at a substantially fixed frequency during a first plurality of periods of the signal to collect a plurality of samples of the signal, wherein each sample includes a phase of the signal and an amplitude of the signal, wherein the substantially fixed frequency is selected to collect one or more samples during each period of the signal at a different phase of the signal than samples collected during an immediately prior period of the signal; and combine the plurality of samples collected over the first plurality of periods of the signal as a function of the phase of the signal to produce a representation of a single period of the signal.

[00195] In another embodiment of the controller, the memory device includes instructions that, when executed by the processor, cause the processor to combining the plurality of samples collected over the first plurality of periods of the signal by combining the plurality of samples collected over a plurality of periods of the signal that ends with a period prior to a second plurality of periods in which the phase of the signal in a first collected sample of the second plurality of periods substantially equals a first phase of the signal in a first collected sample of the first plurality of periods.

[00196] In an embodiment, a multi-electrode ablation system generally comprises a power supply configured to be coupled to a plurality of electrodes; and a controller coupled to the power supply. The controller is configured to: determine a thermal gain of each electrode of the plurality of electrodes; and for each electrode of the plurality of electrodes, set a power limit based at least in part on said electrode's determined thermal gain, wherein the power limit establishes a maximum power that may be dissipated through said electrode.

[00197] In another embodiment of the system, the controller is configured to compare the determined thermal gain of each electrode to a threshold thermal gain. In another embodiment of the system, the controller is configured to set the power limit at a predetermined power limit for each electrode for which the determined thermal gain equals or exceeds the threshold gain. In another embodiment of the system, the controller is configured to set the power limit at a reduced power limit having a value less than the predetermined power limit for each electrode for which the determined thermal gain is less than the threshold gain. In another embodiment of the system, the controller is configured to calculate the reduced power limit as a function of the amount by which the determined thermal gain for an electrode is less than the threshold gain. In another embodiment of the system, the controller is configured to calculate the reduced power limit as the predetermined power limit minus the product of a scaling factor and the amount by which the determined thermal gain for an electrode is less than the threshold gain.

[00198] In another embodiment of the system, the controller is configured, for each electrode, to set and maintain the power limit at a predetermined power limit until at least one startup condition for said electrode has been met. In another embodiment of the system, the at least one startup condition is a temperature of said electrode reaching a predetermined temperature threshold. In another embodiment of the system, the at least one startup condition is an energy dissipated through said electrode reaching a predetermined energy threshold. In another embodiment of the system, the at least one startup condition is the first to occur of a temperature of said electrode reaching a predetermined temperature threshold and an energy dissipated through said electrode reaching a predetermined energy threshold.

[00199] In an embodiment of a method of operating a multi-electrode ablation system, the method generally comprises: determining a thermal gain of each electrode of a plurality of electrodes; and for each electrode of the plurality of electrodes, setting a power limit based at least in part on said electrode's determined thermal gain, wherein the power limit establishes a maximum power that may be dissipated through said electrode.

[00200] In another embodiment, the method further comprises comparing the determined thermal gain of each electrode to a threshold thermal gain. In another embodiment of the method, setting a power limit based at least in part on said electrode's determined thermal gain comprises setting the power limit at a predetermined power limit for each electrode for which the determined thermal gain equals or exceeds the threshold gain. In another embodiment of the method, setting a power limit based at least in part on said electrode's determined thermal gain further comprises setting the power limit at a reduced power limit having a value less than the predetermined power limit for each electrode for which the determined thermal gain is less than the threshold gain. In another embodiment, the method further comprises calculating the reduced power limit as a function of the amount by which the determined thermal gain for a respective electrode is less than the threshold gain. In another embodiment of the method, calculating the reduced power limit comprises subtracting the product of a scaling factor and the amount by which the determined

thermal gain for an electrode is less than the threshold gain from the predetermined power limit.

[00201] In another embodiment, the method further comprises setting and maintaining the power limit at a predetermined power limit until at least one startup condition for said electrode has been met. In another embodiment of the method, setting and maintaining the power limit at a predetermined power limit until at least one startup condition has been met comprises setting the power limit for an electrode at the predetermined power limit until a temperature of said electrode reaches a predetermined temperature threshold. In another embodiment of the method, setting and maintaining the power limit at a predetermined power limit until at least one startup condition has been met comprises setting the power limit for an electrode at the predetermined power limit until an energy dissipated through said electrode reaches a predetermined energy threshold. In another embodiment of the method, setting and maintaining the power limit at a predetermined power limit until at least one startup condition has been met comprises setting the power limit for an electrode at the predetermined power limit until the first to occur of a temperature of said electrode reaches a predetermined temperature threshold and an energy dissipated through said electrode reaches a predetermined energy threshold.

[00202] In an embodiment, a multi-electrode ablation system generally comprises a power supply configured to be coupled to a plurality of electrodes; and a controller coupled to the power supply. The controller is configured to: set a power limit for each electrode of the plurality of electrodes, wherein the power limit establishes a maximum power that may be dissipated through said electrode; determine a thermal gain of each electrode of the plurality of electrodes; and for each electrode of the plurality of electrodes, determine whether or not to reduce the power limit for said electrode based at least in part on the determined thermal gain of said electrode.

[00203] In another embodiment of the system, the controller is further configured to compare the determined thermal gain for each electrode to a threshold thermal gain. In another embodiment of the system, the controller is

configured to determine not to reduce the power limit for an electrode when the determined thermal gain for said electrode is greater than or equal to the threshold thermal gain. In another embodiment of the system, the controller is configured to determine to reduce the power limit for an electrode when the determined thermal gain for said electrode is less than the threshold thermal gain. In another embodiment of the system, the threshold thermal gain is about twenty degrees Celsius per watt. In another embodiment of the system, the threshold thermal gain is about fifteen degrees Celsius per watt.

[00204] In another embodiment of the system, the controller is further configured to reduce the power limit for an electrode by an amount proportional to a difference value that is the difference between the determined thermal gain for said electrode and a threshold thermal gain when the determined thermal gain for said electrode is less than the threshold thermal gain. In another embodiment of the system, the amount by which the power limit is reduced is determined by the product of a scaling factor and the difference value. In another embodiment of the system, the scaling factor is about 0.5. In another embodiment of the system, the scaling factor is about 0.3.

[00205] In another embodiment of the system, setting a power limit for each electrode of the plurality of electrodes comprises setting a power limit of eight watts for each electrode of the plurality of electrodes.

[00206] In an embodiment of a method of operating a multi-electrode ablation system, the method generally comprises: setting a power limit for each electrode of a plurality of electrodes, wherein the power limit establishes a maximum power that may be dissipated through said electrode; determining a thermal gain of each electrode of the plurality of electrodes; and for each electrode of the plurality of electrodes, determining whether or not to reduce the power limit for said electrode based at least in part on the determined thermal gain of said electrode.

[00207] In another embodiment, the method further comprises comparing the determined thermal gain for each electrode to a threshold thermal gain.

In another embodiment of the method, determining whether or not to reduce the power limit comprises determining not to reduce the power limit for an electrode when the determined thermal gain for said electrode is greater than or equal to the threshold thermal gain. In another embodiment of the method, determining whether or not to reduce the power limit comprises determining to reduce the power limit for an electrode when the determined thermal gain for said electrode is less than the threshold thermal gain. In another embodiment of the method, the threshold thermal gain is about twenty degrees Celsius per watt. In another embodiment of the method, the threshold thermal gain is about fifteen degrees Celsius per watt.

[00208] In another embodiment, the method further comprises reducing the power limit for an electrode by an amount proportional to a difference value that is the difference between the determined thermal gain for said electrode and a threshold thermal gain when the determined thermal gain for said electrode is less than the threshold thermal gain. In another embodiment of the method, the amount by which the power limit is reduced is determined by the product of a scaling factor and the difference value. In another embodiment of the method, the scaling factor is about 0.5. In another embodiment of the method, the scaling factor is about 0.3.

[00209] In another embodiment of the method, setting a power limit for each electrode of the plurality of electrodes comprises setting a power limit of eight watts for each electrode of the plurality of electrodes.

[00210] In an embodiment of a method of beginning an ablation procedure using a multi-electrode ablation system, the method generally comprises: selectively coupling the output of a power supply to a first electrode of a plurality of electrodes to increase a temperature at the first electrode to a first temperature set-point and limit a rate of increase of the temperature at the first electrode to a predetermined first rate.

[00211] In another embodiment, the method further comprises: selectively coupling the output of the power supply to a second electrode of the plurality of electrodes to increase a temperature at the second electrode to a second

temperature set-point and limit a rate of increase of the temperature at the second electrode to a predetermined second rate. In another embodiment of the method, the first rate and the second rate are substantially the same. In another embodiment of the method, selectively coupling the output of the power supply to a second electrode comprises selectively coupling the output of the power supply to the second electrode a delay period after selectively coupling the output of the power supply to the first electrode. In another embodiment of the method, the delay period lasts until the temperature at the first electrode reaches the first predetermined temperature set-point. In another embodiment of the method, the delay period is a predetermined fixed length of time. In another embodiment of the method, the first temperature set-point and the second temperature set-point are substantially the same.

[00212] In another embodiment, the method further comprises selectively coupling the output of the power supply to the first electrode after the first electrode reaches the first temperature set-point to increase the temperature at the first electrode to a second temperature set-point and limit the rate of increase of the temperature at the first electrode to a predetermined second rate. In another embodiment of the method, the first rate and the second rate are different rates. In another embodiment of the method, the second temperature set-point is greater than the first temperature set-point. In another embodiment of the method, the first rate and the second rate are substantially the same.

[00213] In another embodiment, the method further comprises selectively coupling the output of the power supply to the first electrode to maintain the temperature at the first electrode substantially at the first set-point for at least a first dwell period after the temperature reaches the first temperature set-point. In another embodiment, the method further comprises selectively coupling the output of the power supply to the first electrode after the first dwell period to increase the temperature at the first electrode to a second temperature set-point and limit the rate of increase of the temperature at the first electrode to a predetermined second rate.

[00214] In an embodiment, a multi-electrode ablation system generally comprises a power supply configured to be coupled to a plurality of

electrodes; and a controller coupled to the power supply. The controller is configured to: selectively couple the output of the power supply to a first electrode of the plurality of electrodes to increase a temperature at the first electrode to a first temperature set-point and limit an increase of the temperature at the first electrode to a predetermined first rate.

[00215] In another embodiment of the system the controller is further configured to: selectively couple the output of the power supply to a second electrode of the plurality of electrodes to increase a temperature at the second electrode to a second temperature set-point and limit a rate of increase of the temperature at the second electrode to a predetermined second rate. In another of the system, the first rate and the second rate are substantially the same. In another embodiment of the system, selectively coupling the output of the power supply to a second electrode comprises selectively coupling the output of the power supply to the second electrode a delay period after selectively coupling the output of the power supply to the first electrode. In another embodiment of the system, the delay period lasts until the temperature at the first electrode reaches the first predetermined temperature set-point. In another embodiment of the system, the delay period is a predetermined fixed length of time. In another embodiment of the system, the first temperature set-point and the second temperature set-point are substantially the same.

[00216] In another embodiment of the system, the controller is further configured to selectively couple the output of the power supply to the first electrode after the first electrode reaches the first temperature set-point to increase the temperature at the first electrode to a second temperature set-point and limit the increase of the temperature at the first electrode to a predetermined second rate. In another embodiment of the system, the first rate and the second rate are different rates. In another embodiment of the system, the second temperature set-point is greater than the first temperature set-point. In another embodiment of the system, the first rate and the second rate are substantially the same.

[00217] In another embodiment of the system, the controller is further configured to selectively couple the output of the power supply to the first

electrode to maintain the temperature at the first electrode substantially at the first set-point for at least a first dwell period after the temperature reaches the first temperature set-point. In another embodiment of the system, the controller is further configured to selectively couple the output of the power supply to the first electrode after the first dwell period to increase the temperature at the first electrode to a second temperature set-point and limit a rate of increase of the temperature at the first electrode to a predetermined second rate.

[00218] In an embodiment of a method of beginning an ablation procedure using a multi-electrode ablation system, the method generally comprises: increasing a temperature at each electrode of a plurality of electrodes until the temperature at each electrode reaches a first temperature set-point, wherein a rate of increase of the temperature at each electrode is limited to a predetermined first rate of increase.

[00219] In another embodiment of the method, increasing a temperature at each electrode comprises increasing a temperature at each electrode beginning at substantially a same time for each electrode of the plurality of electrodes.

[00220] In another embodiment of the method, increasing a temperature at each electrode comprises increasing a temperature at each electrode beginning at a first time for at least a first electrode and at a second time for at least a second electrode, wherein the second time is different from the first time.

[00221] In another embodiment of the method, increasing a temperature at each electrode comprises increasing a temperature at each electrode beginning at a different time for each electrode of the plurality of electrodes.

[00222] In another embodiment of the method, the predetermined first rate of increase is not the same for each electrode of the plurality of electrodes.

[00223] In another embodiment, the method further comprises increasing the temperature at each electrode after the temperature reaches the first temperature set-point at a predetermined second rate of increase until the temperature

at each electrode reaches a second temperature set-point. In another embodiment, the method further comprises maintaining each electrode at substantially the second temperature set-point after the temperature reaches the second temperature set-point. In another embodiment of the method, increasing the temperature at each electrode after the temperature reaches the first temperature set-point comprises increasing a temperature at each electrode beginning at substantially a same time for each electrode of the plurality of electrodes. In another embodiment of the method, increasing the temperature at each electrode after the temperature reaches the first temperature set-point comprises increasing a temperature at each electrode beginning at a first time for at least a first electrode and at a second time for at least a second electrode, wherein the second time is different from the first time. In another embodiment of the method, increasing the temperature at each electrode after the temperature reaches the first temperature set-point comprises increasing a temperature at each electrode beginning at a different time for each electrode of the plurality of electrodes. In another embodiment of the method, the predetermined second rate of increase is not the same for each electrode of the plurality of electrodes. In another embodiment of the method, the predetermined second rate of increase is substantially the same as the predetermined first rate of increase. In another embodiment of the method, the predetermined second rate of increase is different than the predetermined first rate of increase.

[00224] In another embodiment, the method further comprises maintaining each electrode at substantially the first temperature set-point for at least a first dwell period after the temperature reaches the first temperature set-point. In another embodiment, the method further comprises increasing the temperature at each electrode after the first dwell period at a predetermined second rate of increase until the temperature at each electrode reaches a second temperature set-point.

[00225] In an embodiment, a multi-electrode ablation system generally comprises a power supply configured to be coupled to a plurality of electrodes; and a controller coupled to the power supply. The controller is configured to: increase a temperature at each electrode of the plurality of electrodes until the temperature at each electrode reaches a first temperature set-point, wherein a rate of

increase of the temperature at each electrode is limited to a predetermined first rate of increase.

[00226] In another embodiment of the system, increasing a temperature at each electrode comprises increasing a temperature at each electrode beginning at substantially a same time for each electrode of the plurality of electrodes.

[00227] In another embodiment of the system, increasing a temperature at each electrode comprises increasing a temperature at each electrode beginning at a first time for at least a first electrode and at a second time for at least a second electrode, wherein the second time is different from the first time.

[00228] In another embodiment of the system, increasing a temperature at each electrode comprises increasing a temperature at each electrode beginning at a different time for each electrode of the plurality of electrodes.

[00229] In another embodiment of the system, the predetermined first rate of increase is not the same for each electrode of the plurality of electrodes.

[00230] In another embodiment of the system, increasing the temperature at each electrode after the temperature reaches the first temperature set-point at a predetermined second rate of increase until the temperature at each electrode reaches a second temperature set-point. In another embodiment, the system further comprises maintaining each electrode at substantially the second temperature set-point after the temperature reaches the second temperature set-point. In another embodiment of the system, increasing the temperature at each electrode after the temperature reaches the first temperature set-point comprises increasing the temperature at each electrode beginning at substantially a same time for each electrode of the plurality of electrodes. In another embodiment of the system, increasing the temperature at each electrode after the temperature reaches the first temperature set-point comprises increasing the temperature at each electrode beginning at a first time for at least a first electrode and at a second time for at least a second electrode, wherein the second time is different from the first time. In another embodiment of the system, increasing the temperature at each electrode after the

temperature reaches the first temperature set-point comprises increasing the temperature at each electrode beginning at a different time for each electrode of the plurality of electrodes. In another embodiment of the system, the predetermined second rate of increase is not the same for each electrode of the plurality of electrodes. In another embodiment of the system, the predetermined second rate of increase is substantially the same as the predetermined first rate of increase. In another embodiment of the system, the predetermined second rate of increase is different than the predetermined first rate of increase.

[00231] In another embodiment of the system, the controller is further configured to maintain each electrode at substantially the first temperature set-point for at least a first dwell period after the temperature reaches the first temperature set-point. In another embodiment of the system, the controller is further configured to increase the temperature at each electrode after the first dwell period at a predetermined second rate of increase until the temperature at each electrode reaches a second temperature set-point.

[00232] Although certain embodiments of this disclosure have been described above with a certain degree of particularity, those skilled in the art could make numerous alterations to the disclosed embodiments without departing from the spirit or scope of this disclosure. All directional references (e.g., upper, lower, upward, downward, left, right, leftward, rightward, top, bottom, above, below, vertical, horizontal, clockwise, and counterclockwise) are only used for identification purposes to aid the reader's understanding of the present disclosure, and do not create limitations, particularly as to the position, orientation, or use of the disclosure. Joinder references (e.g., attached, coupled, connected, and the like) are to be construed broadly and may include intermediate members between a connection of elements and relative movement between elements. As such, joinder references do not necessarily infer that two elements are directly connected and in fixed relation to each other. It is intended that all matter contained in the above description or shown in the accompanying drawings shall be interpreted as illustrative only and not limiting. Changes in detail or structure may be made without departing from the spirit of the disclosure as defined in the appended claims.

[00233] When introducing elements of the present disclosure or the various versions, embodiment(s) or aspects thereof, the articles "a", "an", "the" and "said" are intended to mean that there are one or more of the elements. The terms "comprising", "including" and "having" are intended to be inclusive and mean that there may be additional elements other than the listed elements. The use of terms indicating a particular orientation (e.g., "top", "bottom", "side", etc.) is for convenience of description and does not require any particular orientation of the item described.

[00234] As various changes could be made in the above without departing from the scope of the disclosure, it is intended that all matter contained in the above description and shown in the accompanying drawings shall be interpreted as illustrative and not in a limiting sense.

WHAT IS CLAIMED IS:

1. A multi-electrode ablation system comprising:

a power supply configured to be coupled to a plurality of electrodes;

and

a controller coupled to the power supply, the controller configured to:

determine a thermal gain of each electrode of the plurality of electrodes; and

for each electrode of the plurality of electrodes, set a power limit based at least in part on said electrode's determined thermal gain, wherein the power limit establishes a maximum power that may be dissipated through said electrode.
2. The system set forth in claim 1 wherein the controller is configured to compare the determined thermal gain of each electrode to a threshold thermal gain.
3. The system set forth in claim 2 wherein the controller is configured to set the power limit at a predetermined power limit for each electrode for which the determined thermal gain equals or exceeds the threshold gain.
4. The system set forth in claim 1 wherein the controller is configured, for each electrode, to set and maintain the power limit at a predetermined power limit until at least one startup condition for said electrode has been met.
5. The system set forth in claim 4 wherein the at least one startup condition is a temperature of said electrode reaching a predetermined temperature threshold.
6. The system set forth in claim 4 wherein the at least one startup condition is an energy dissipated through said electrode reaching a predetermined energy threshold.

7. The system set forth in claim 4 wherein the at least one startup condition is the first to occur of a temperature of said electrode reaching a predetermined temperature threshold and an energy dissipated through said electrode reaching a predetermined energy threshold.

8. A multi-electrode ablation system comprising:

a power supply configured to be coupled to a plurality of electrodes;
and

a controller coupled to the power supply, the controller configured to:

set a power limit for each electrode of the plurality of electrodes,
wherein the power limit establishes a maximum power that may be dissipated through said electrode;

determine a thermal gain of each electrode of the plurality of electrodes; and

for each electrode of the plurality of electrodes, determine whether or not to reduce the power limit for said electrode based at least in part on the determined thermal gain of said electrode.

9. The system set forth in claim 8 wherein the controller is further configured to compare the determined thermal gain for each electrode to a threshold thermal gain.

10. The system set forth in claim 9 wherein the controller is configured to determine not to reduce the power limit for an electrode when the determined thermal gain for said electrode is greater than or equal to the threshold thermal gain.

11. The system set forth in claim 9 wherein the controller is configured to determine to reduce the power limit for an electrode when the determined thermal gain for said electrode is less than the threshold thermal gain.

12. The system set forth in claim 9 wherein the threshold thermal gain is about twenty degrees Celcius per watt.

13. The system set forth in claim 8 wherein the controller is further configured to reduce the power limit for an electrode by an amount proportional to a difference value that is the difference between the determined thermal gain for said electrode and a threshold thermal gain when the determined thermal gain for said electrode is less than the threshold thermal gain.

14. The system set forth in claim 13 wherein the amount by which the power limit is reduced is determined by the product of a scaling factor and the difference value.

15. The system set forth in claim 8 wherein setting a power limit for each electrode comprises setting a power limit of eight watts for each electrode of the plurality of electrodes.

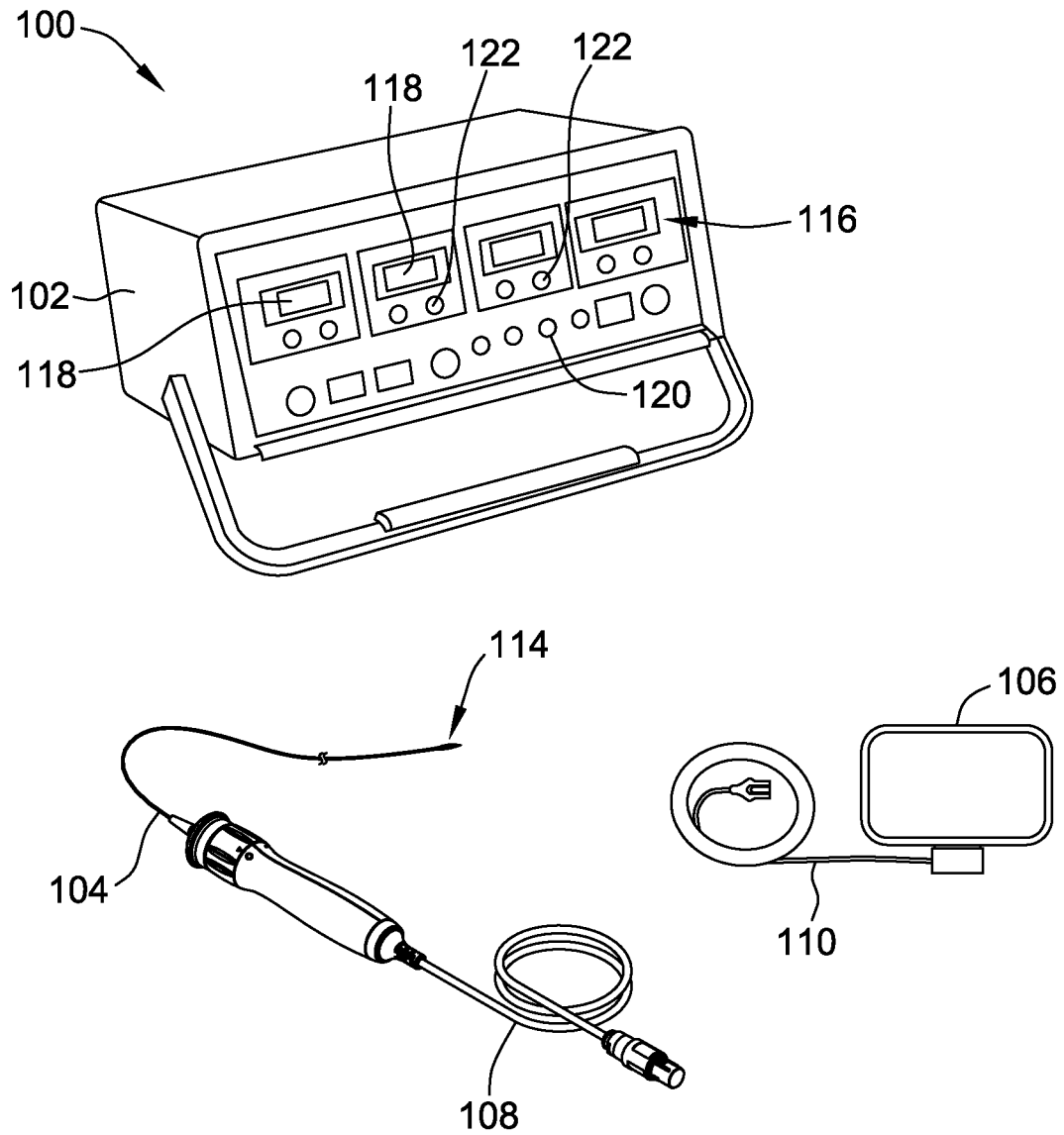

FIG. 1

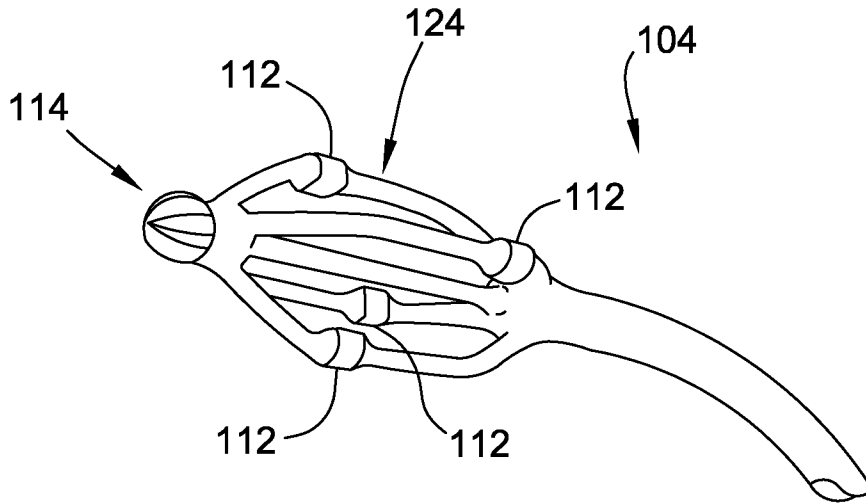

FIG. 2

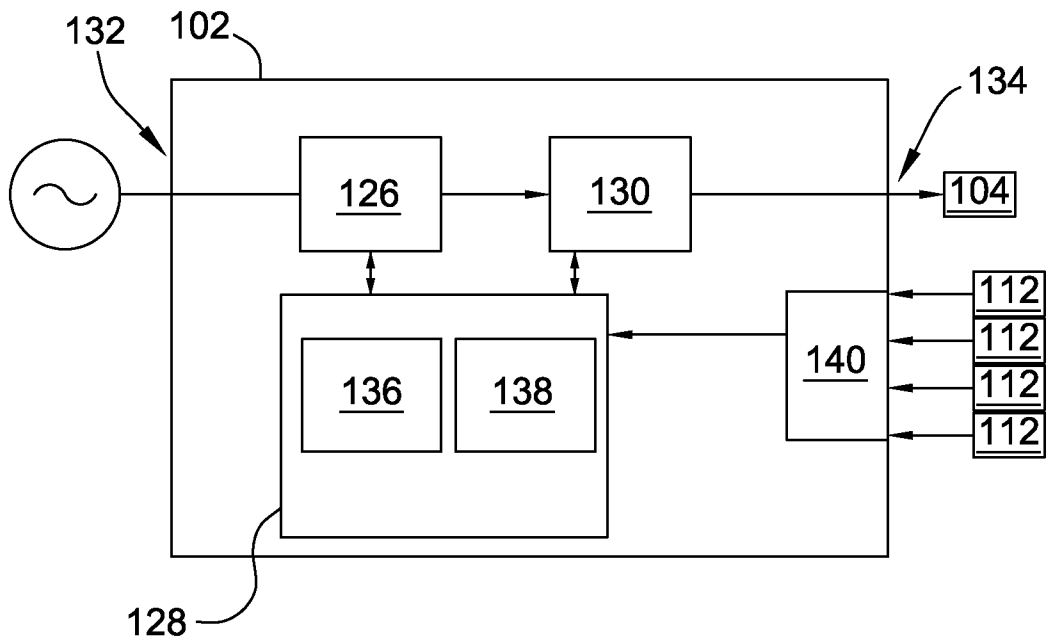

FIG. 3

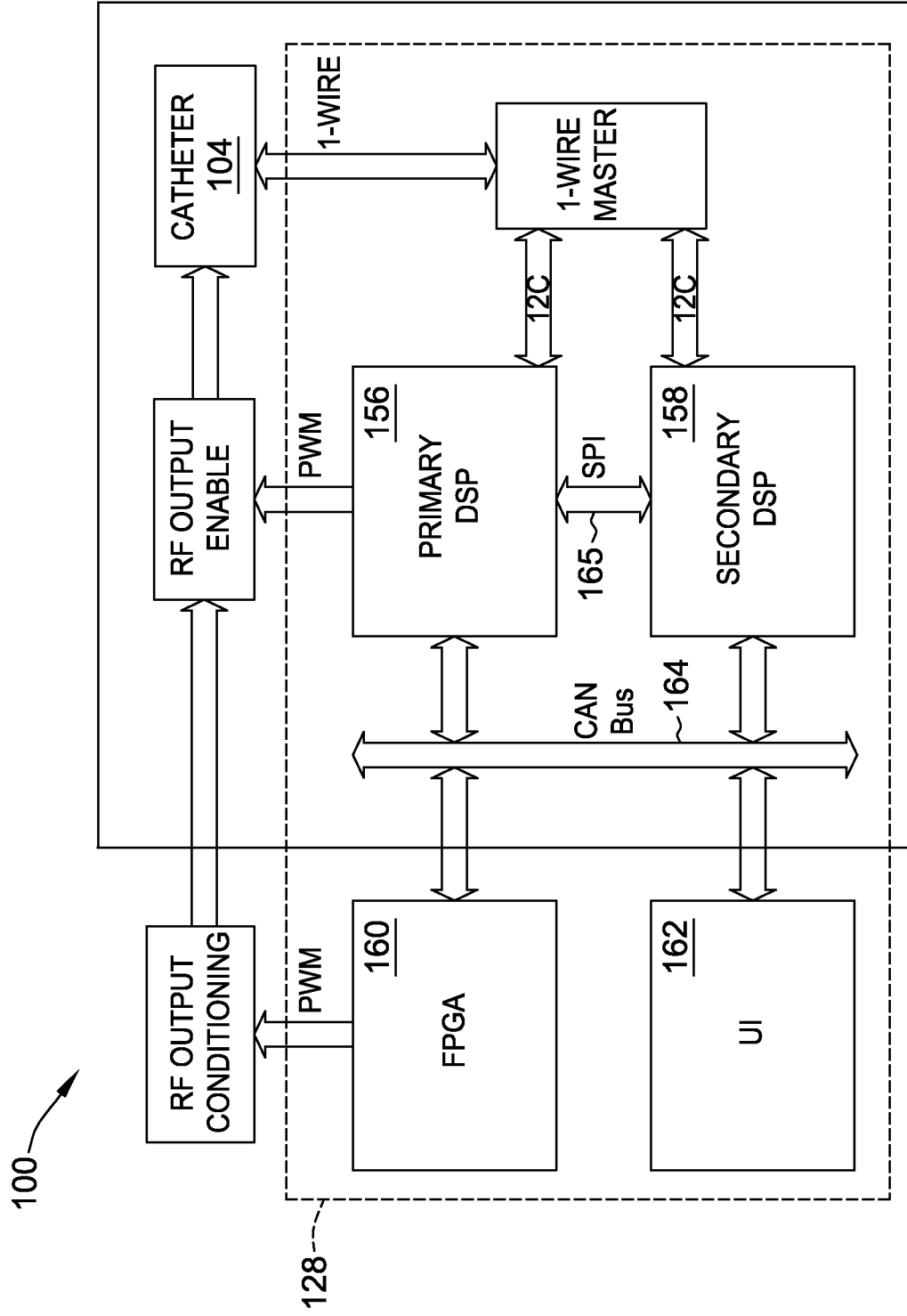

FIG. 4

4/21

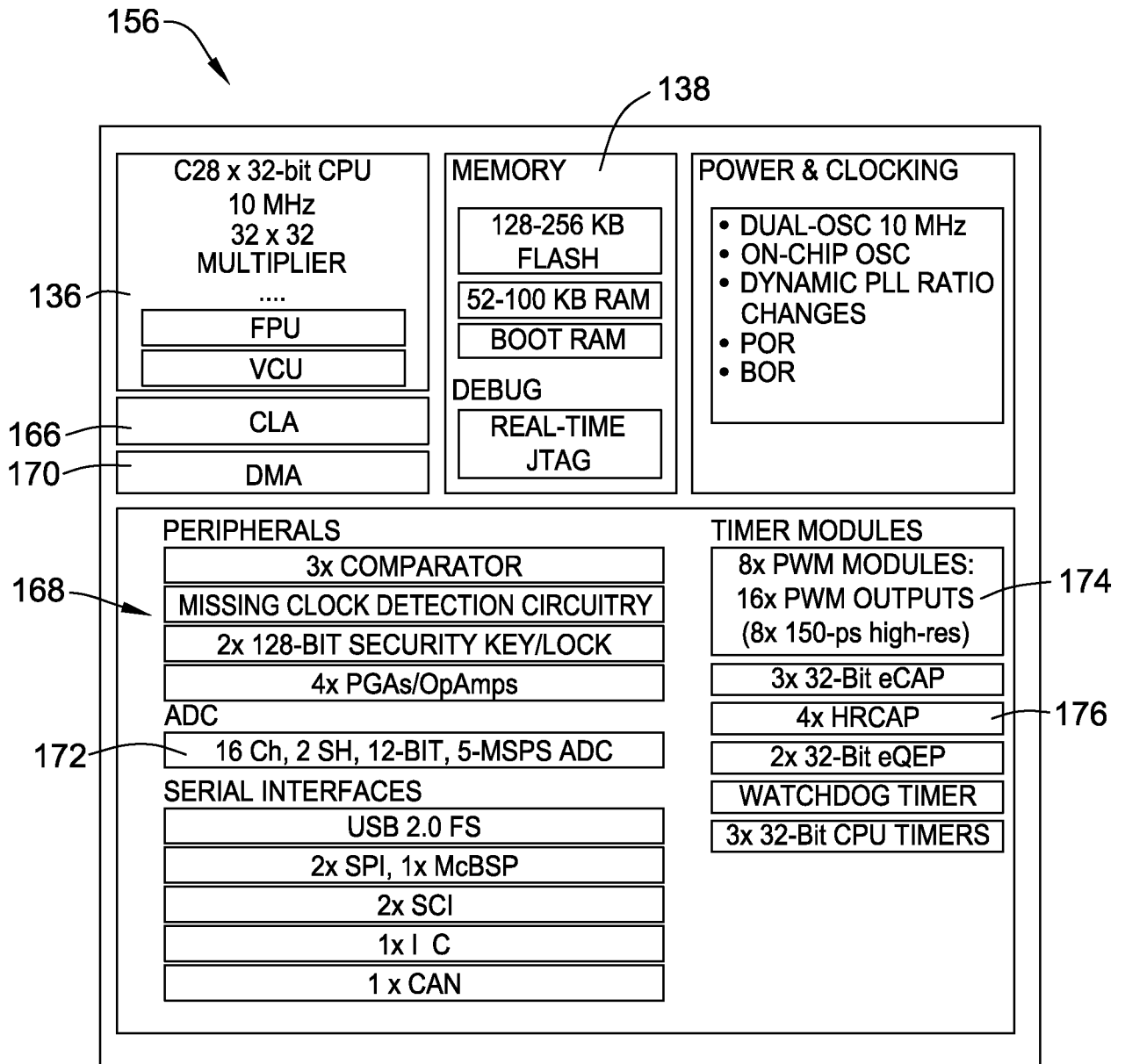

FIG. 5

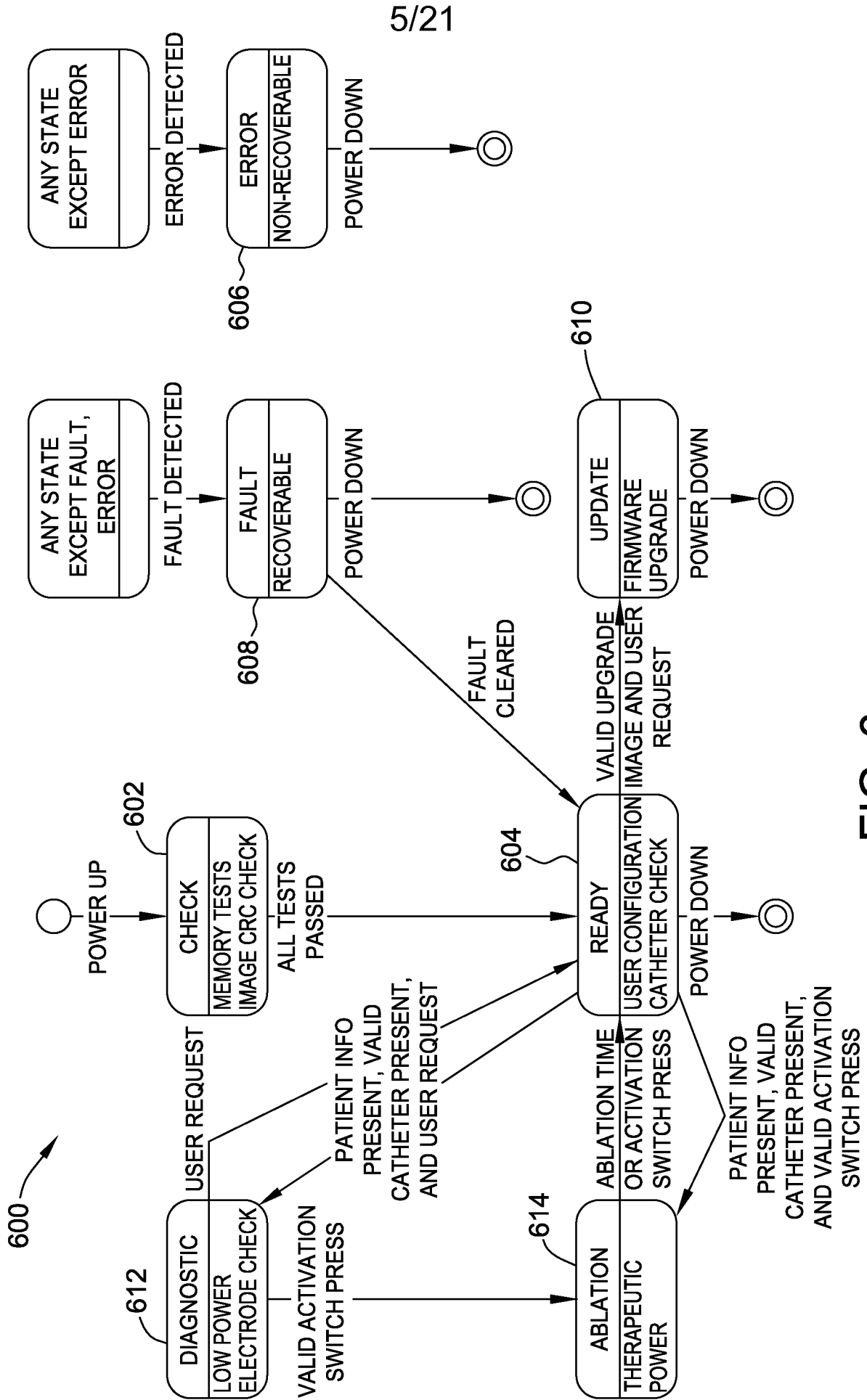

FIG. 6

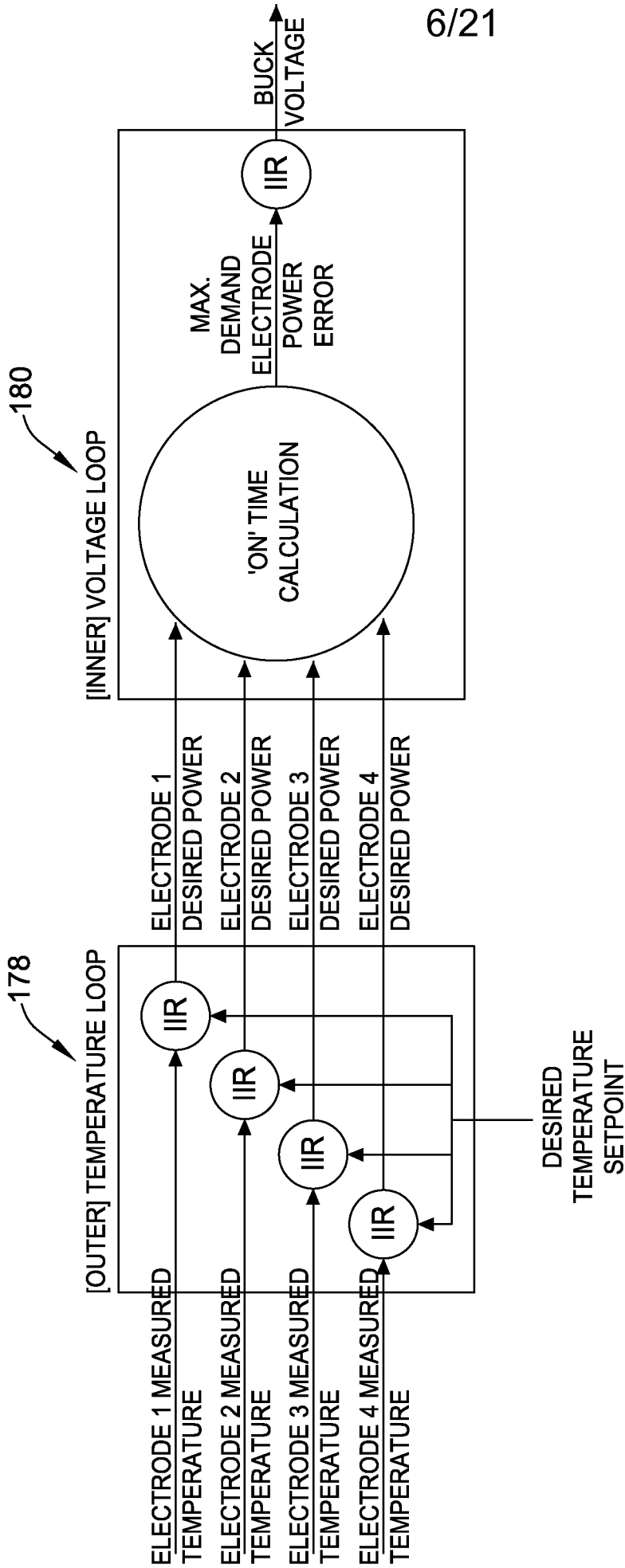

FIG. 7

7/21

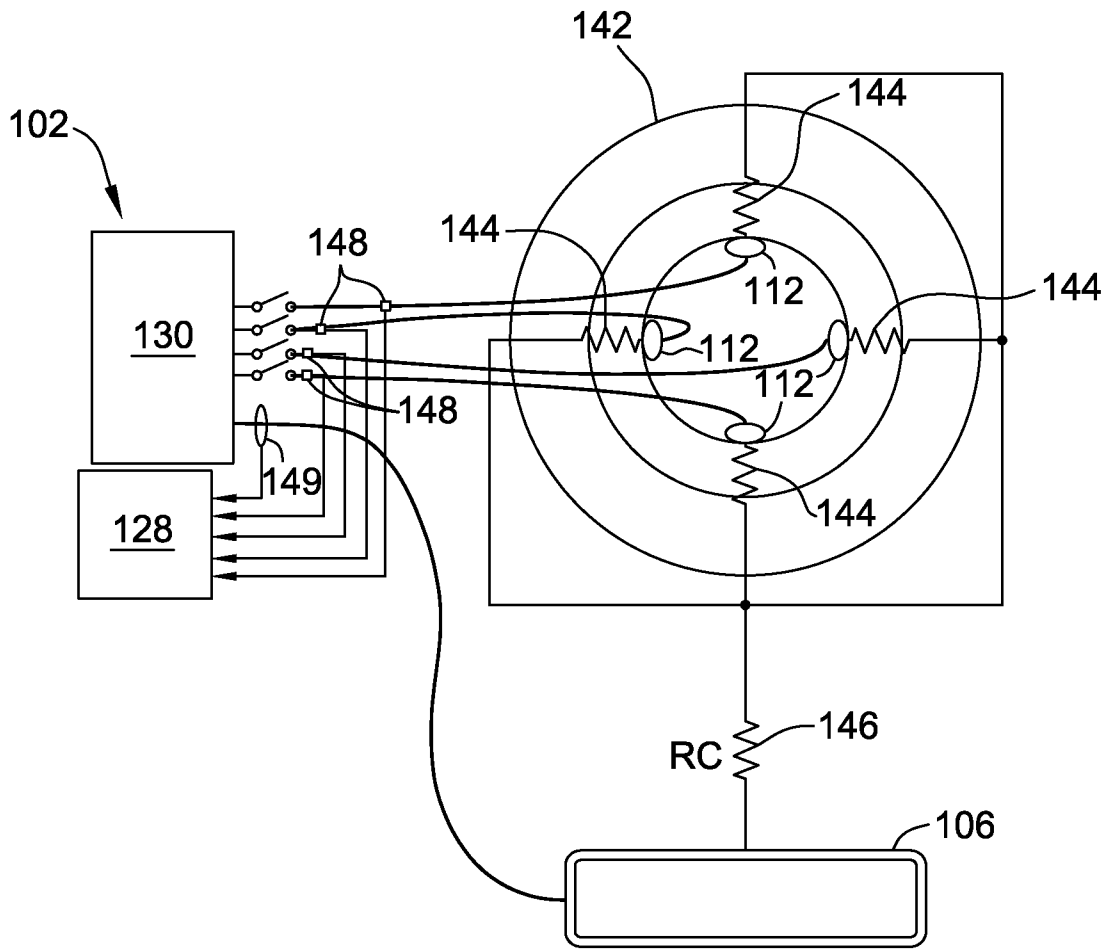

FIG. 8

8/21

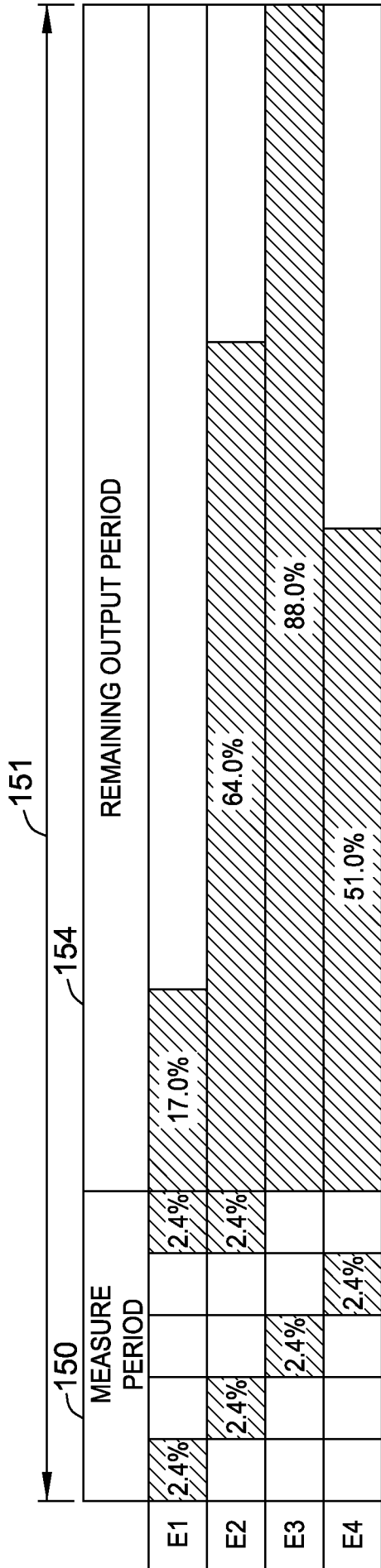

FIG. 9

152 152 152 152 152

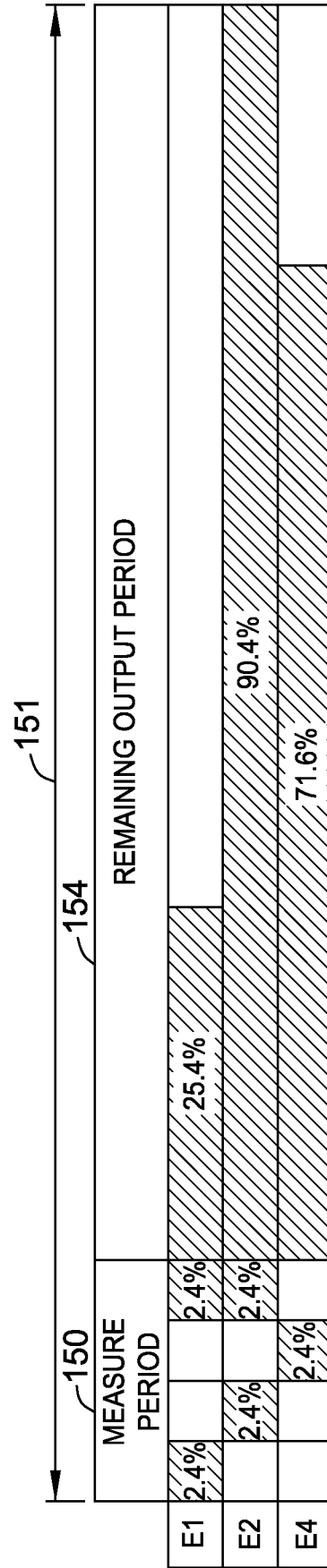
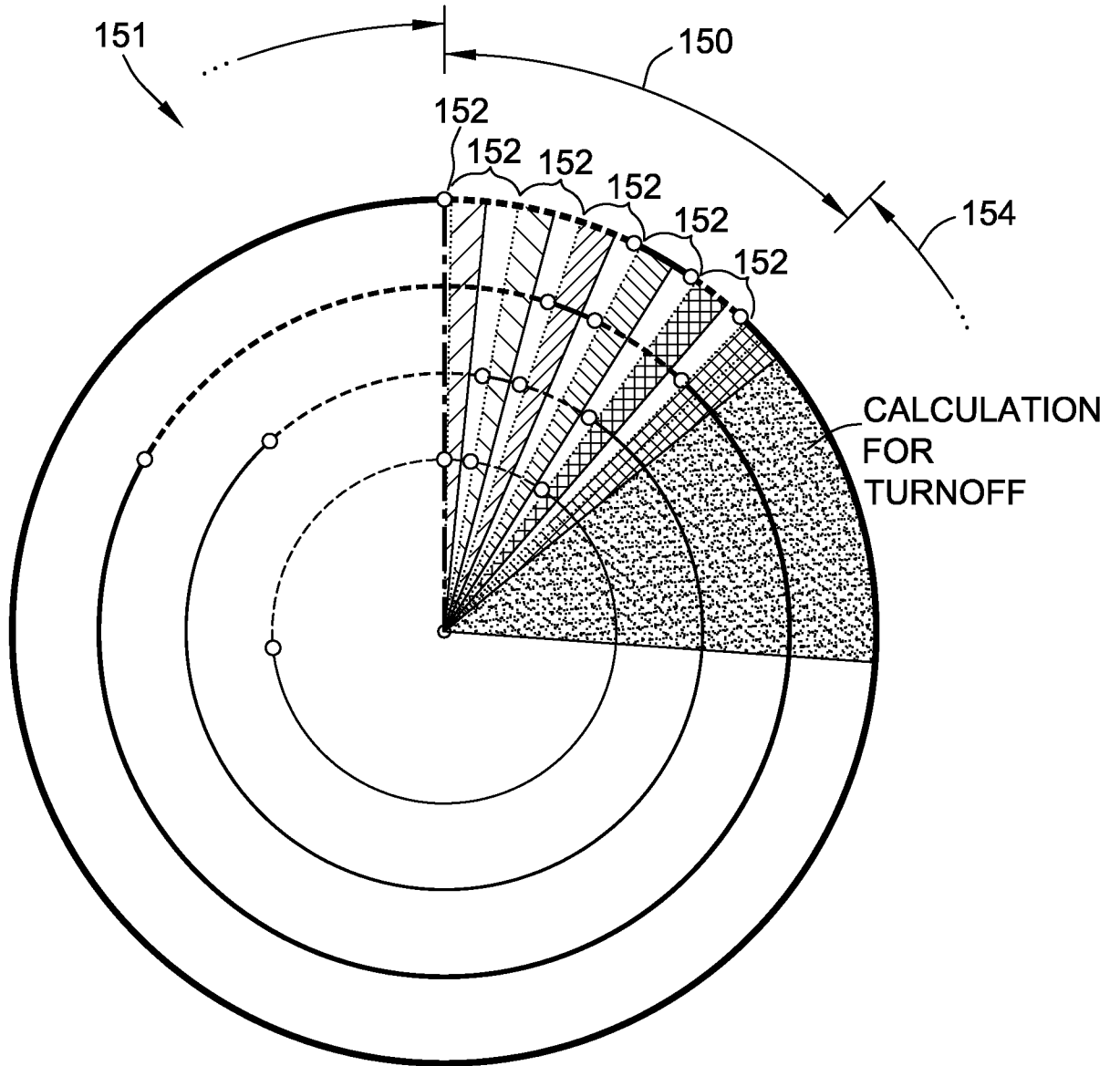

FIG. 10

152 152 152 152

9/21







-  START OF CYCLE
-  ELECTRODE CONNECTED
-  ELECTRODE DISCONNECTED
-  INTERRUPT
-  ADC SAMPLING (CLA)
-  MAIN CPU PROCESSING

FIG. 11

10/21

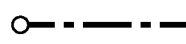
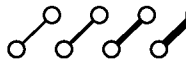
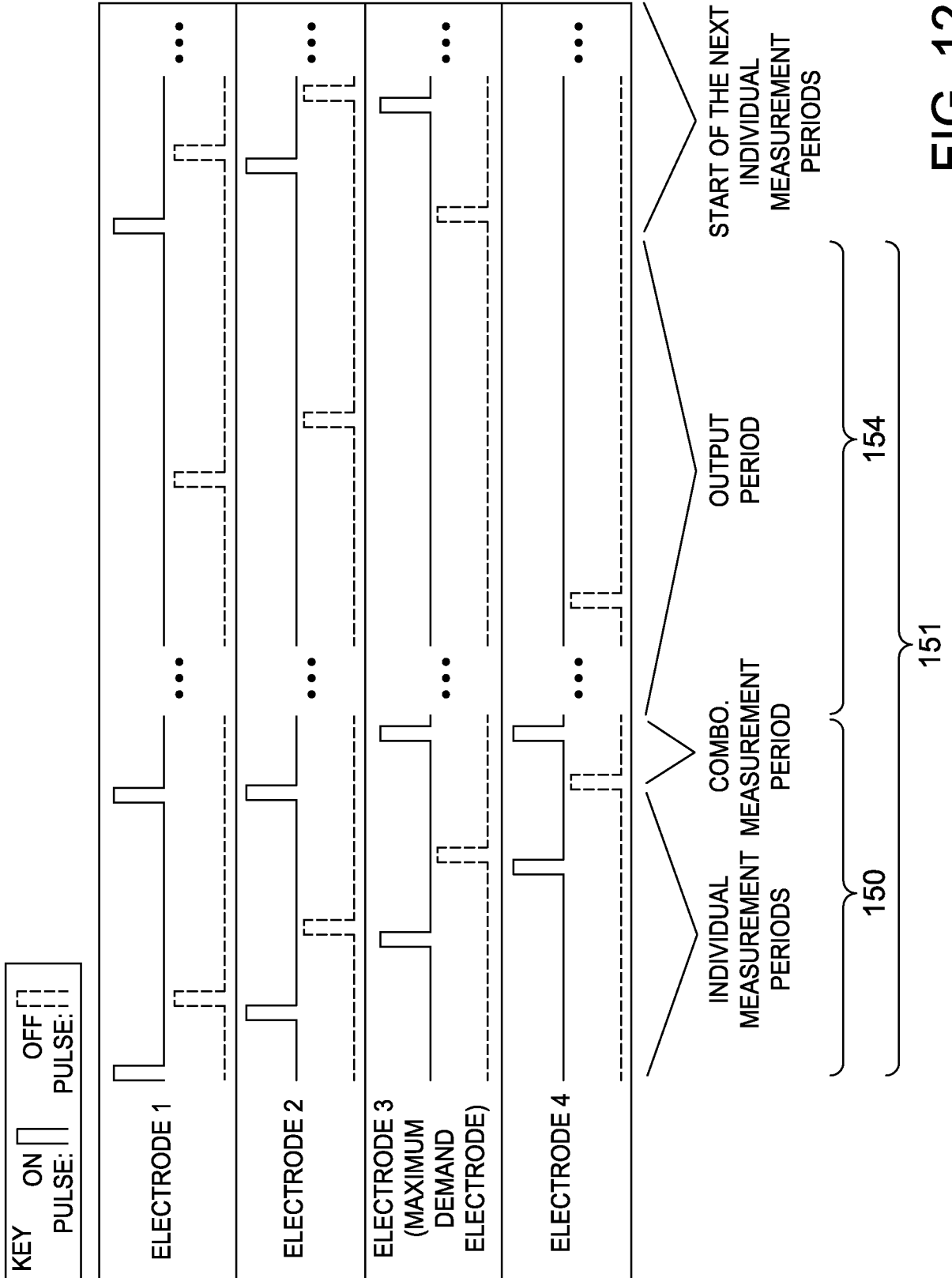

FIG. 12

11/21

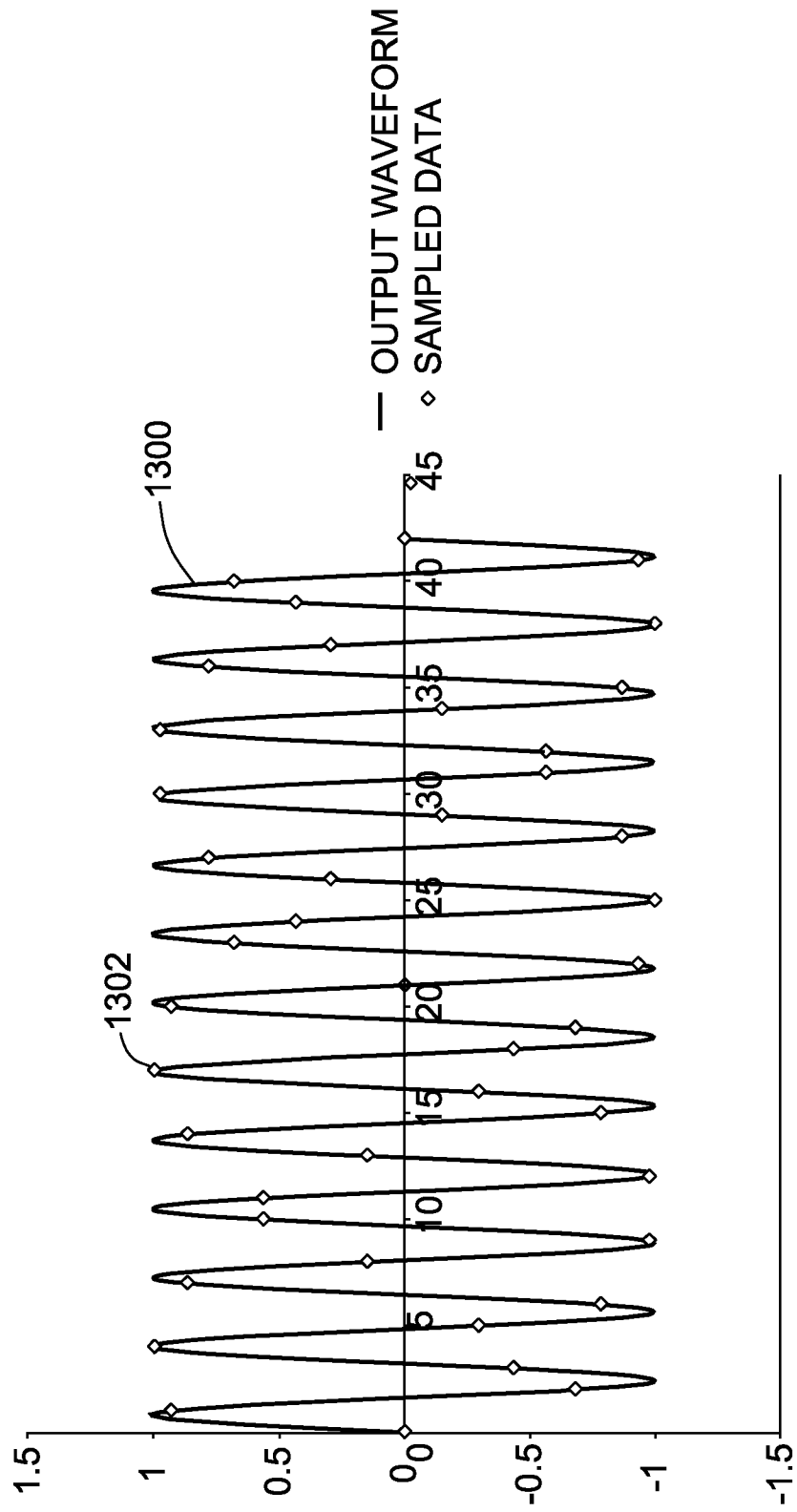

FIG. 13

12/21

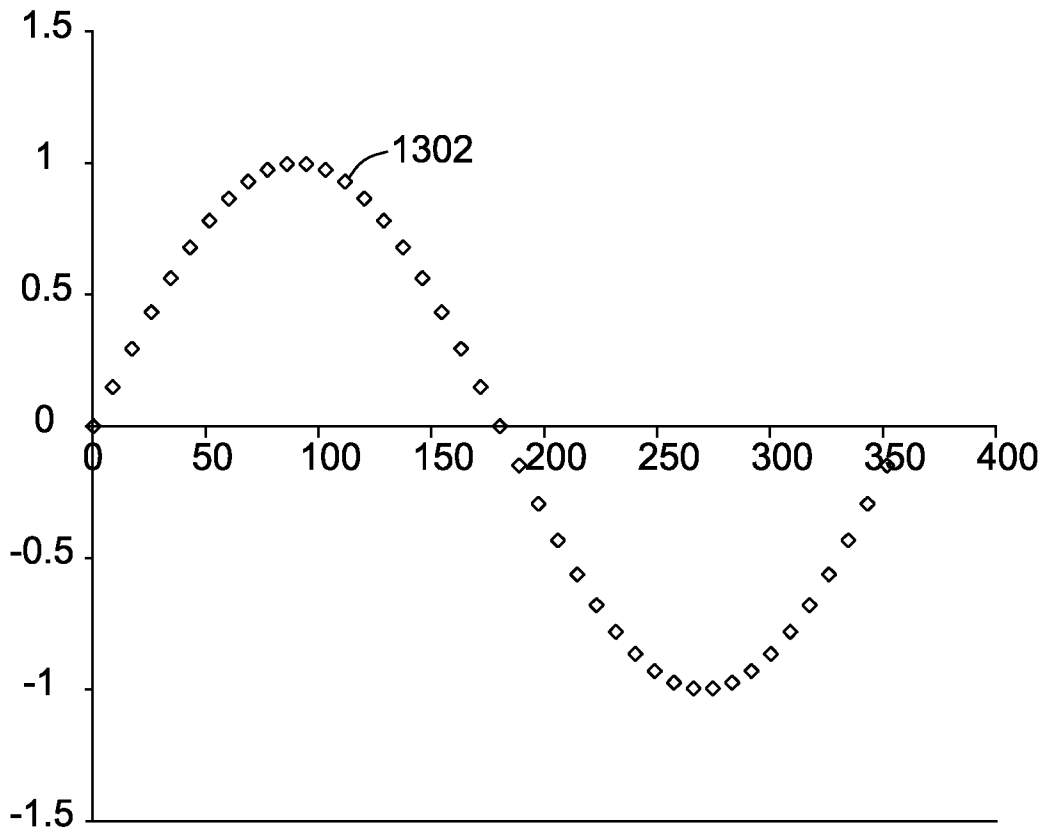

FIG. 14

FIG. 15A

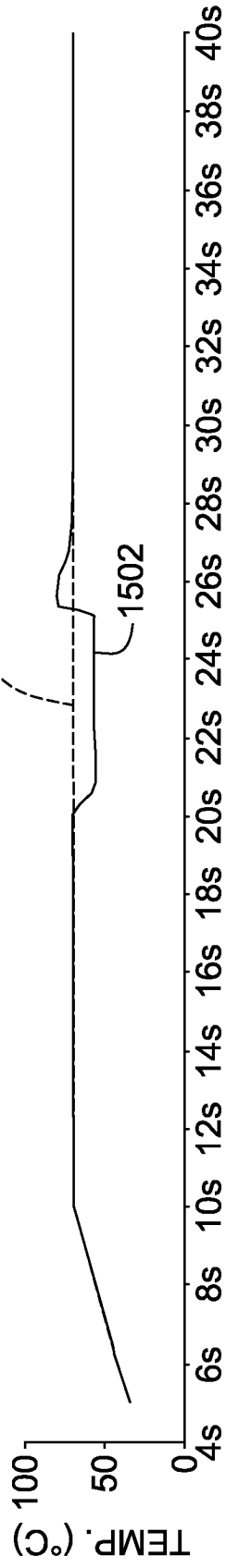

FIG. 15B

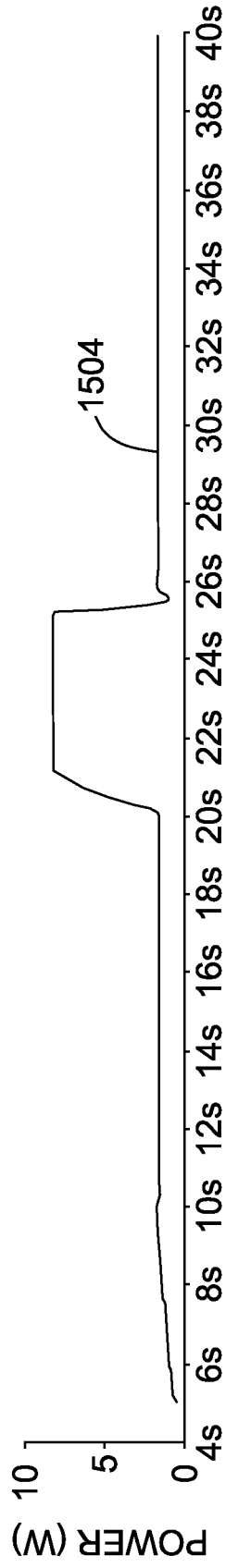

FIG. 15C

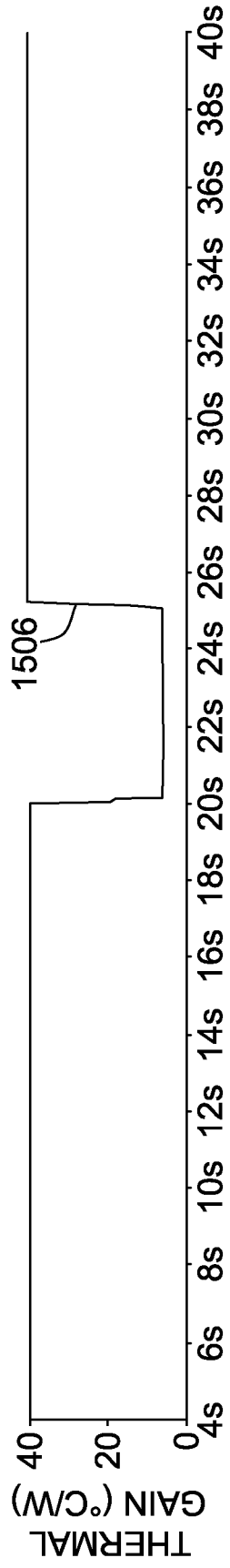

FIG. 16A

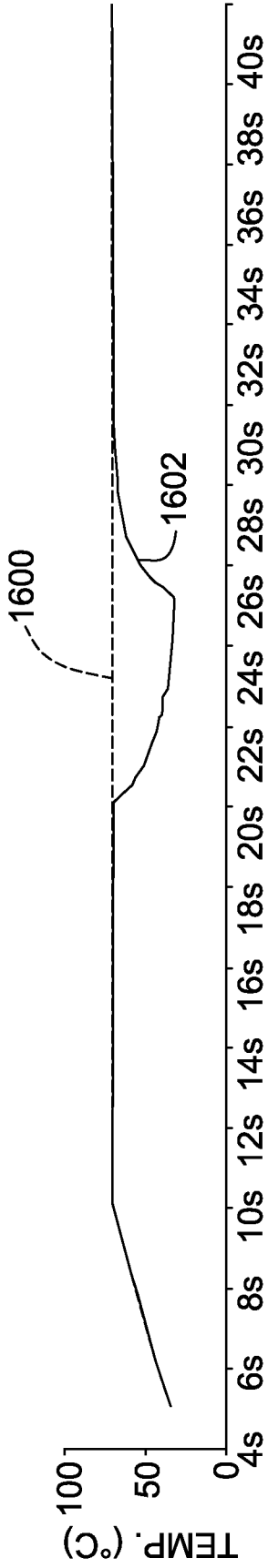

FIG. 16B

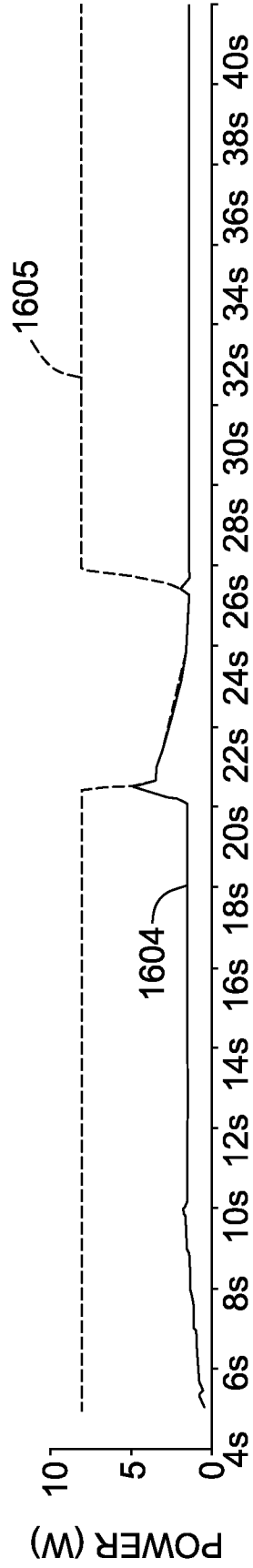
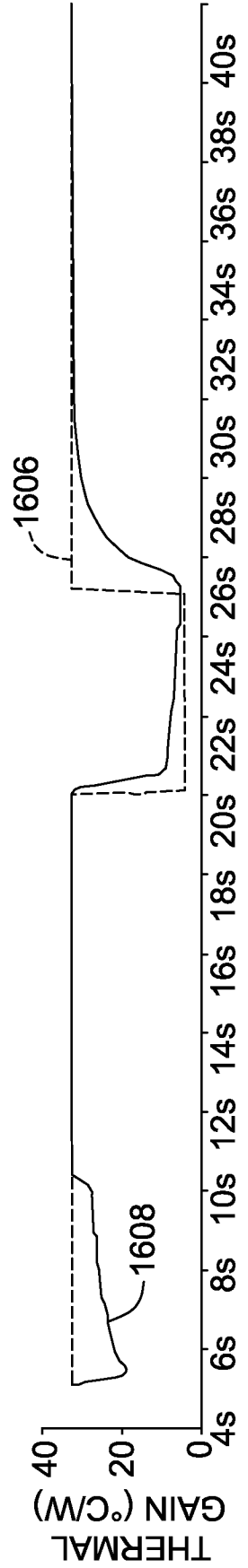

FIG. 16C



15/21

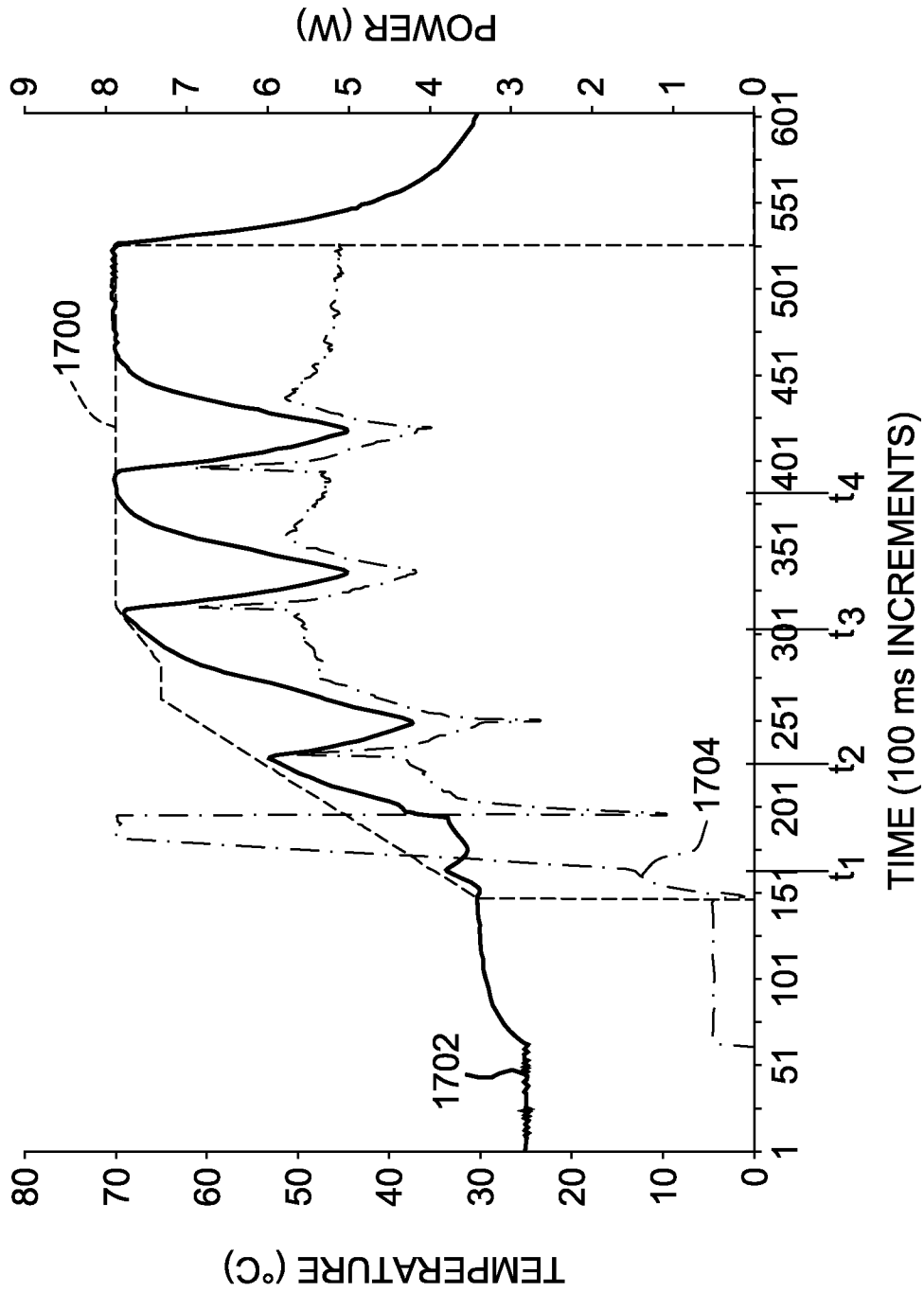

FIG. 17

- 5 per. Mov. Avg. (MaxP4)
- - - Energy4
- · - · - 5 per. Mov. Avg. (PathPwr4)
- Temp4
- - - 5 per. Mov. Avg. (ThermGain4)

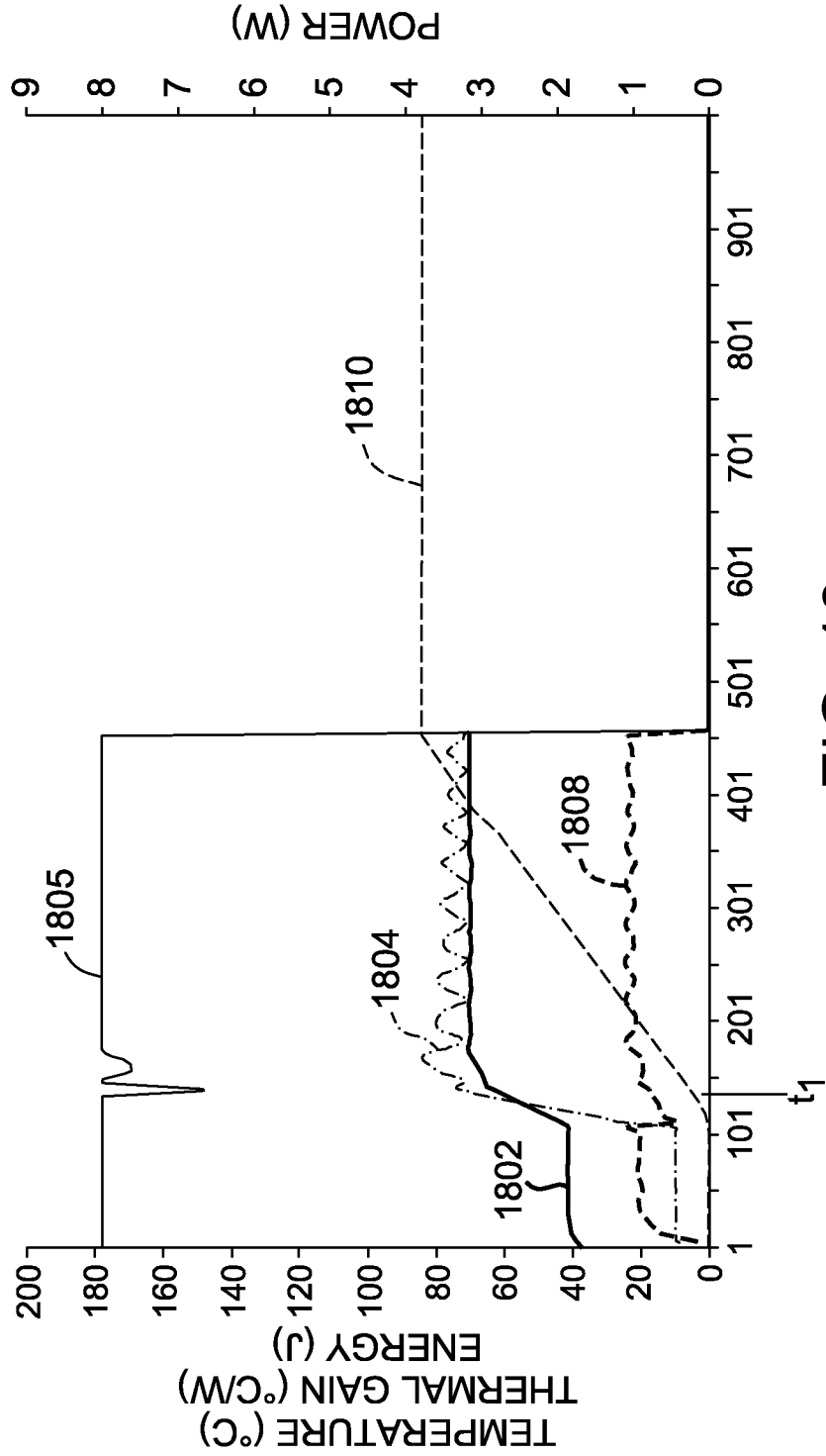

FIG. 18

17/21

- 5 per. Mov. Avg. (MaxP4)
- - - Energy4
- · - · - 5 per. Mov. Avg. (PathPwr4)
- Temp4
- - - 5 per. Mov. Avg. (ThermGain4)

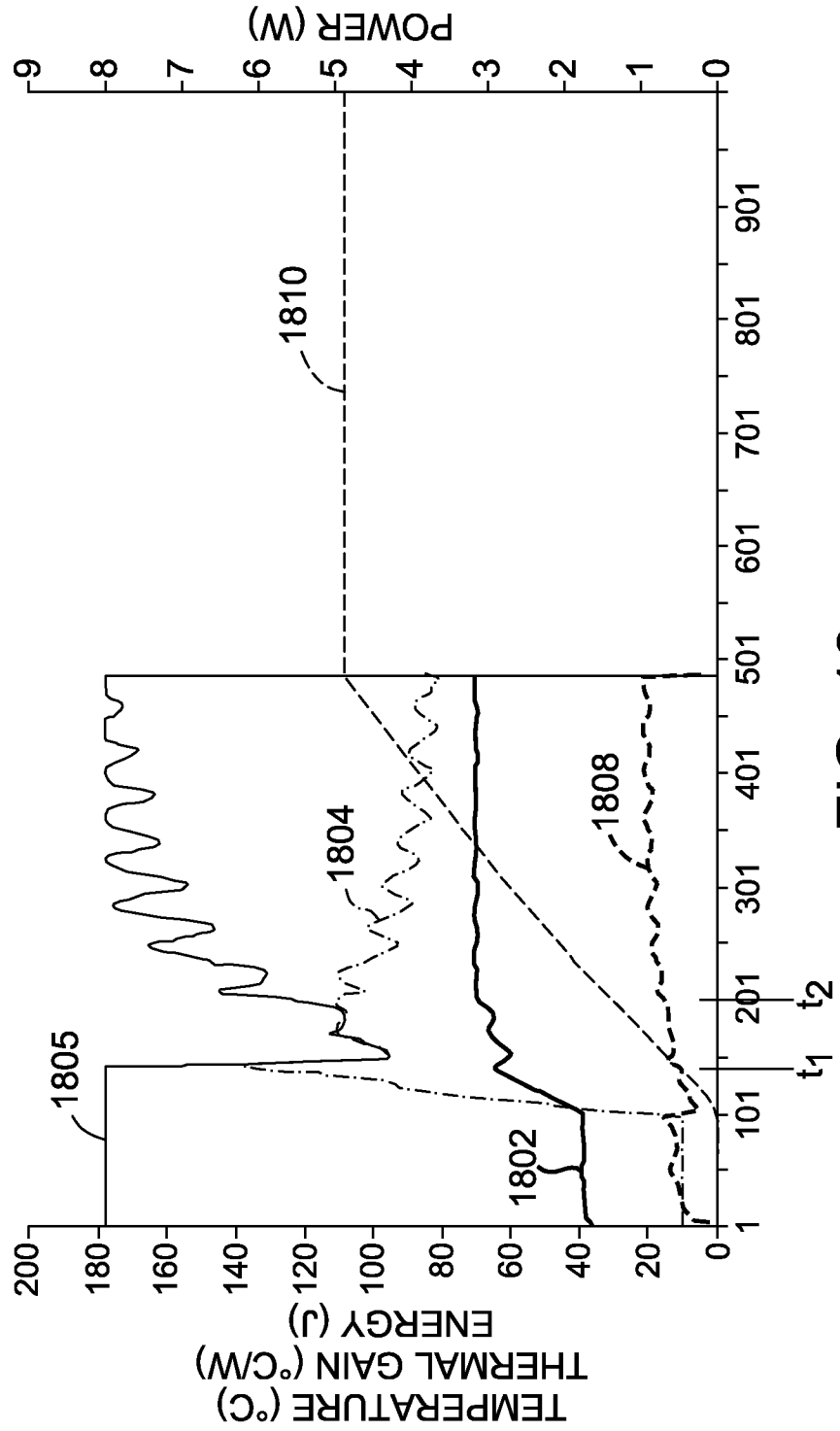

FIG. 19

18/21

- 5 per. Mov. Avg. (MaxP4)
- - - Energy4
- · - 5 per. Mov. Avg. (PathPwr4)
- Temp4
- - - 5 per. Mov. Avg. (ThermGain4)

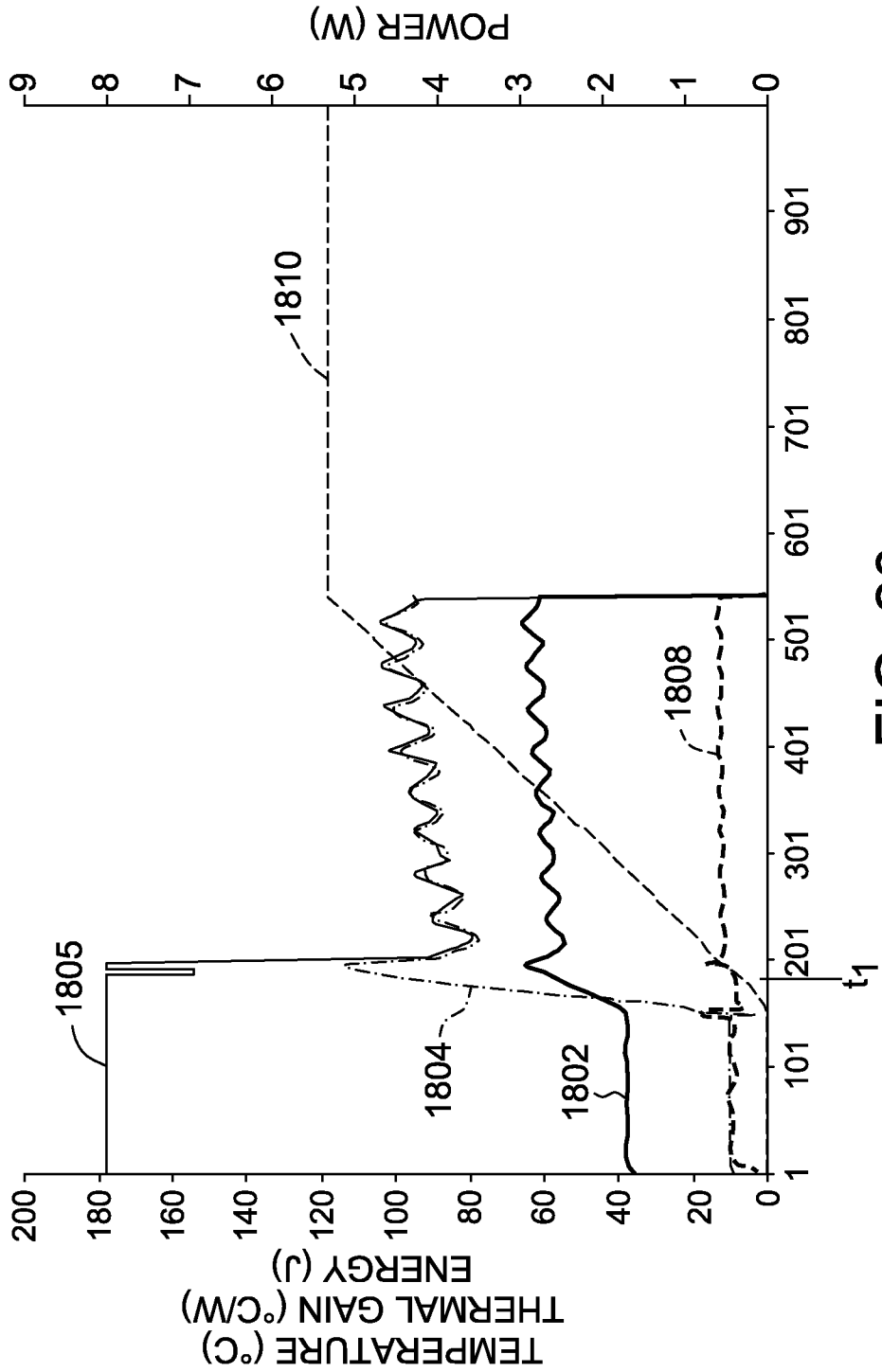

FIG. 20

19/21

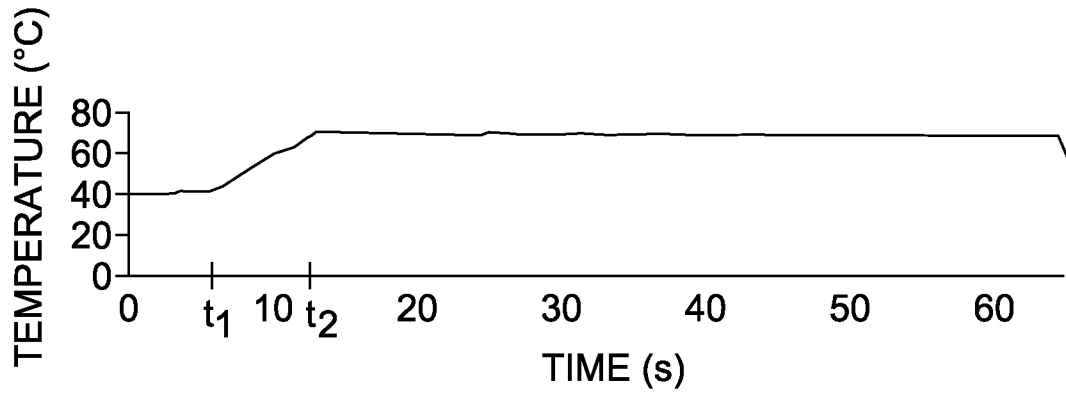

FIG. 21

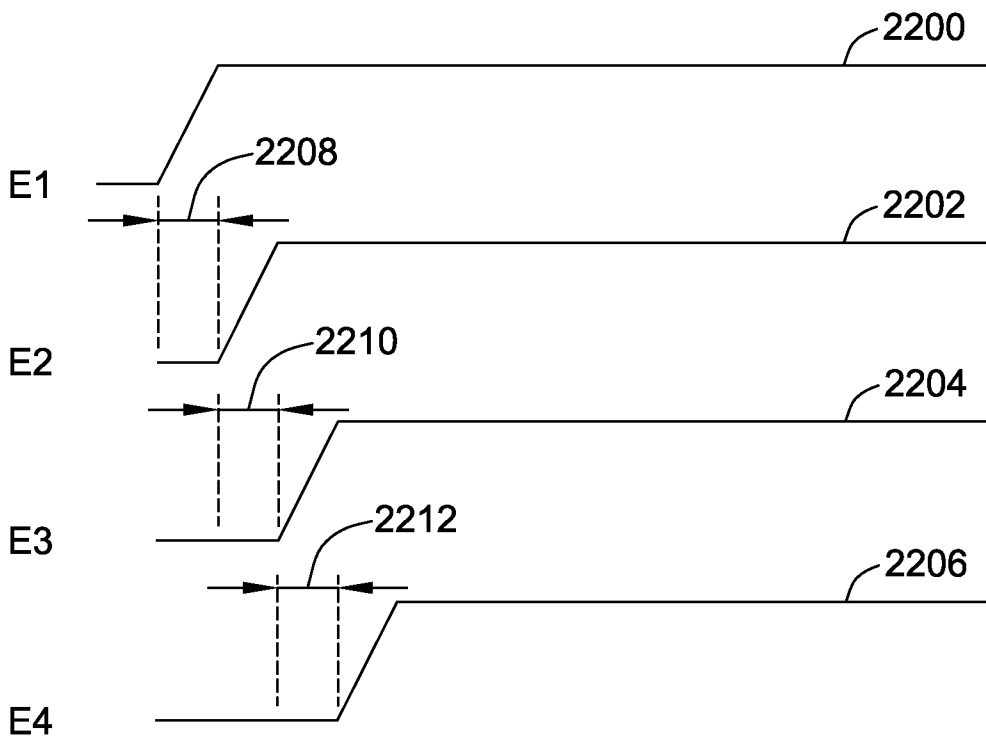

FIG. 22

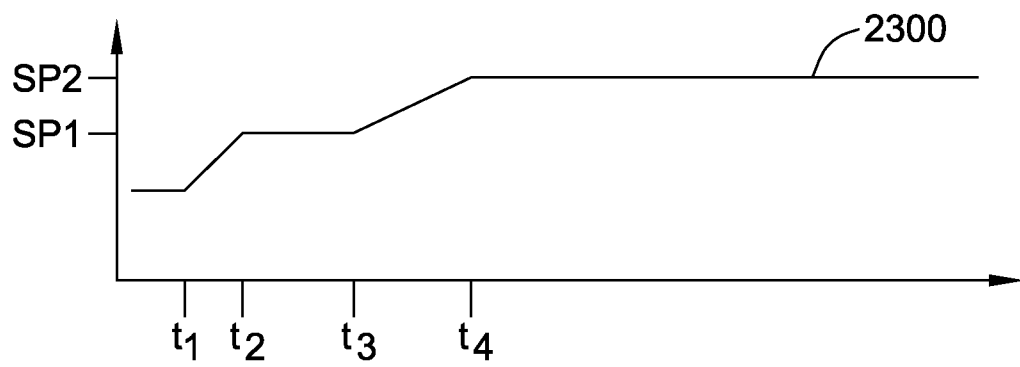

FIG. 23

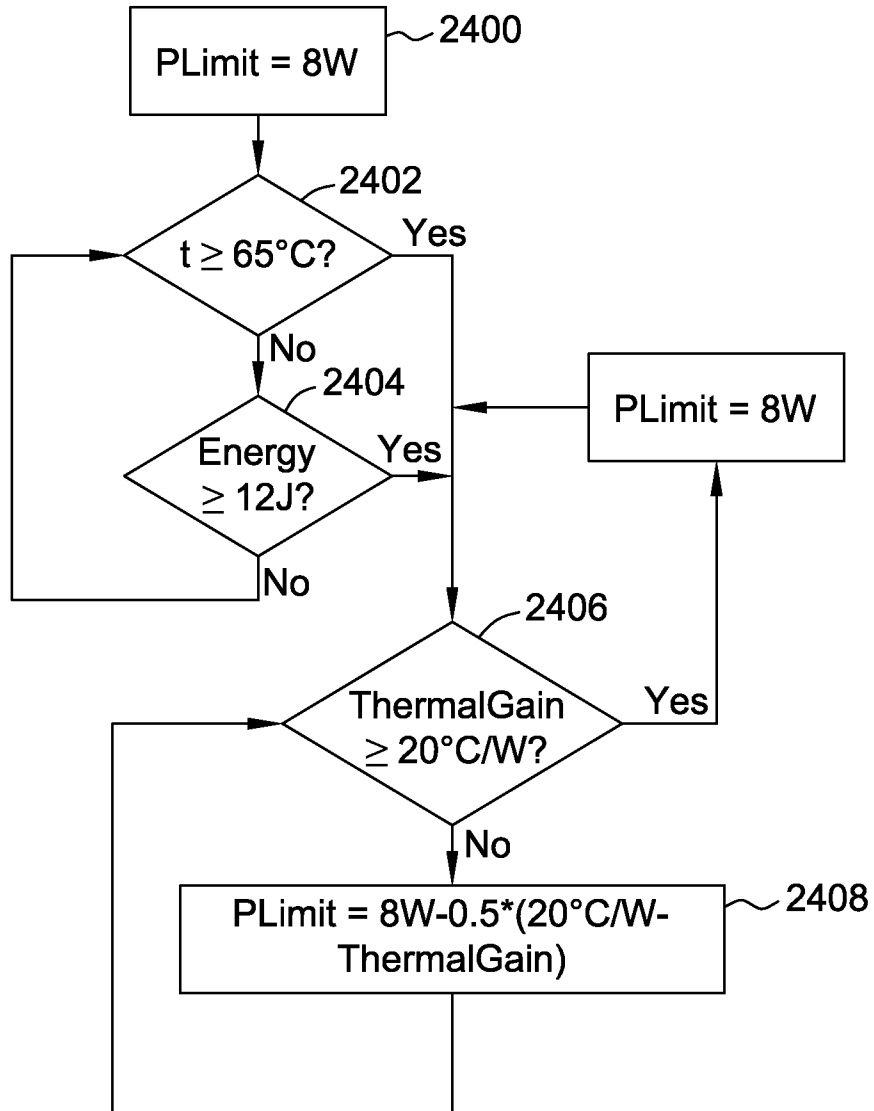

FIG. 24

INTERNATIONAL SEARCH REPORT

International application No PCT/US2014/023221
--

A. CLASSIFICATION OF SUBJECT MATTER INV. A61B18/00 A61B18/12 A61B18/14 ADD.		
According to International Patent Classification (IPC) or to both national classification and IPC		
B. FIELDS SEARCHED		
Minimum documentation searched (classification system followed by classification symbols) A61B		
Documentation searched other than minimum documentation to the extent that such documents are included in the fields searched		
Electronic data base consulted during the international search (name of data base and, where practicable, search terms used) EPO-Internal, WPI Data		
C. DOCUMENTS CONSIDERED TO BE RELEVANT		
Category*	Citation of document, with indication, where appropriate, of the relevant passages	Relevant to claim No.
X	US 2011/152857 A1 (INGLE FRANK [US]) 23 June 2011 (2011-06-23) paragraph [0009] paragraph [0036] - paragraph [0041] paragraph [0048] paragraph [0057] - paragraph [0060]; figure 1 -----	1-4,8-14
X	US 2009/192507 A1 (LUTTICH EDWARD [US]) 30 July 2009 (2009-07-30) paragraph [0015] - paragraph [0019] paragraph [0044] - paragraph [0048] paragraph [0055] paragraph [0066]; figures 3, 6 ----- -/--	1-6,8,9
<input checked="" type="checkbox"/> Further documents are listed in the continuation of Box C. <input checked="" type="checkbox"/> See patent family annex.		
* Special categories of cited documents :		
"A" document defining the general state of the art which is not considered to be of particular relevance "E" earlier application or patent but published on or after the international filing date "L" document which may throw doubts on priority claim(s) or which is cited to establish the publication date of another citation or other special reason (as specified) "O" document referring to an oral disclosure, use, exhibition or other means "P" document published prior to the international filing date but later than the priority date claimed	"T" later document published after the international filing date or priority date and not in conflict with the application but cited to understand the principle or theory underlying the invention "X" document of particular relevance; the claimed invention cannot be considered novel or cannot be considered to involve an inventive step when the document is taken alone "Y" document of particular relevance; the claimed invention cannot be considered to involve an inventive step when the document is combined with one or more other such documents, such combination being obvious to a person skilled in the art "&" document member of the same patent family	
Date of the actual completion of the international search	Date of mailing of the international search report	
8 August 2014	22/08/2014	
Name and mailing address of the ISA/ European Patent Office, P.B. 5818 Patentlaan 2 NL - 2280 HV Rijswijk Tel. (+31-70) 340-2040, Fax: (+31-70) 340-3016	Authorized officer Sigurd, Karin	

INTERNATIONAL SEARCH REPORT

International application No PCT/US2014/023221

C(Continuation). DOCUMENTS CONSIDERED TO BE RELEVANT

Category*	Citation of document, with indication, where appropriate, of the relevant passages	Relevant to claim No.
X	US 2012/101538 A1 (BALLAKUR SOWMYA [US] ET AL) 26 April 2012 (2012-04-26) paragraph [0045] - paragraph [0046] paragraph [0054] - paragraph [0066]; figure 3 -----	1-9, 11, 13-15
A	US 2004/127963 A1 (UCHIDA ANDY H [US] ET AL) 1 July 2004 (2004-07-01) paragraph [0102] paragraph [0110] - paragraph [0117]; figure 10 -----	1-15

INTERNATIONAL SEARCH REPORT

Information on patent family members

International application No PCT/US2014/023221

Patent document cited in search report	Publication date	Publication date	Patent family member(s)	Publication date
US 2011152857	A1	23-06-2011	NONE	
US 2009192507	A1	30-07-2009	US 2009192507 A1	30-07-2009
			WO 2009094604 A1	30-07-2009
US 2012101538	A1	26-04-2012	CN 103313671 A	18-09-2013
			EP 2632373 A1	04-09-2013
			JP 2013544130 A	12-12-2013
			TW 201221114 A	01-06-2012
			US 2012101538 A1	26-04-2012
			WO 2012061153 A1	10-05-2012
US 2004127963	A1	01-07-2004	AU 2003248461 A1	17-03-2005
			US 2004127963 A1	01-07-2004