



US00D782568S

(12) **United States Design Patent**
Nishimura et al.

(10) **Patent No.:** **US D782,568 S**

(45) **Date of Patent:** **** Mar. 28, 2017**

(54) **PRINTER**

(71) Applicants: **Yuta Nishimura**, Ohta-ku (JP);
Takashi Ishida, Ohta-ku (JP)

(72) Inventors: **Yuta Nishimura**, Ohta-ku (JP);
Takashi Ishida, Ohta-ku (JP)

(73) Assignee: **RICOH COMPANY, LTD.**, Tokyo (JP)

(**) Term: **14 Years**

(21) Appl. No.: **29/517,923**

(22) Filed: **Feb. 18, 2015**

(51) **LOC (10) Cl.** **14-02**

(52) **U.S. Cl.**
USPC **D18/55**

(58) **Field of Classification Search**
USPC D18/14, 19, 36-39, 50, 54, 54.1, 55;
D14/420-422, 424-425, 463-470
CPC ... B41J 3/38; B41J 3/4075; B41J 11/48; B41J
11/58; B41J 13/12; B41J 15/02; B41J
15/042; B41J 17/00; B41J 29/02; B41J
29/08
See application file for complete search history.

(56) **References Cited**

U.S. PATENT DOCUMENTS

D529,951 S * 10/2006 Katayama D18/53
D532,449 S * 11/2006 Tjin Wong Joe D18/55

D607,505 S * 1/2010 Sasaki D14/421
D666,239 S * 8/2012 Larson D18/55
D724,140 S 3/2015 Nishimura et al.

* cited by examiner

Primary Examiner — Cathy Anne MacCormac
(74) *Attorney, Agent, or Firm* — Oblon, McClelland,
Maier & Neustadt, L.L.P.

(57) **CLAIM**

The ornamental design for a printer, as shown and described.

DESCRIPTION

FIG. 1 is a front elevational view of a printer;
FIG. 2 is a rear elevational view thereof;
FIG. 3 is a left side elevational view thereof;
FIG. 4 is a right side elevational view thereof;
FIG. 5 is a top plan view thereof;
FIG. 6 is a bottom plan view thereof;
FIG. 7 is a front, top, and left side perspective view thereof;
FIG. 8 is a rear, top, and right side perspective view thereof;
and,
FIG. 9 is a front, top, and right side perspective view thereof.
The broken lines in the drawings depict environmental
subject matter only and form no part of the claimed design.

1 Claim, 9 Drawing Sheets

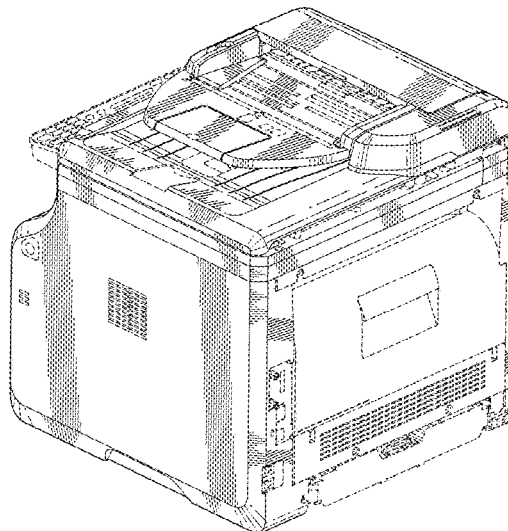
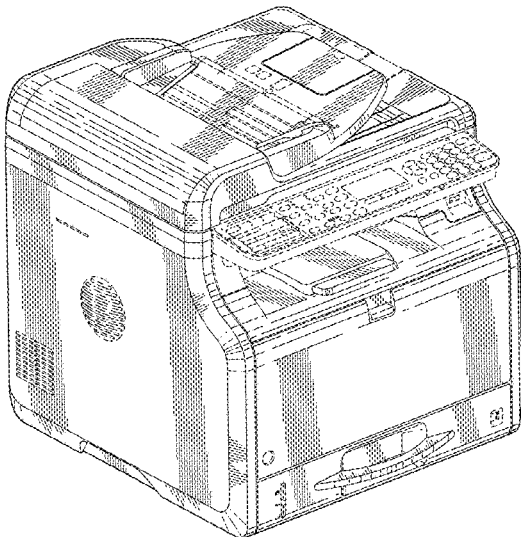

FIG. 1

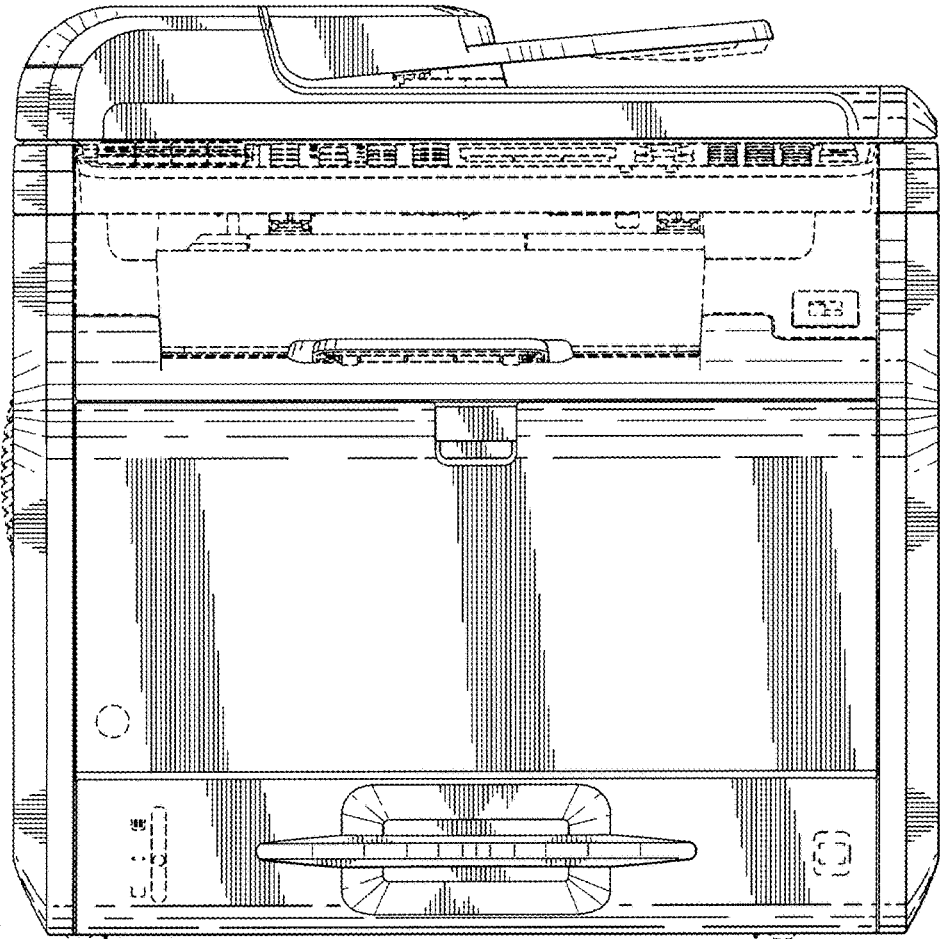

FIG.2

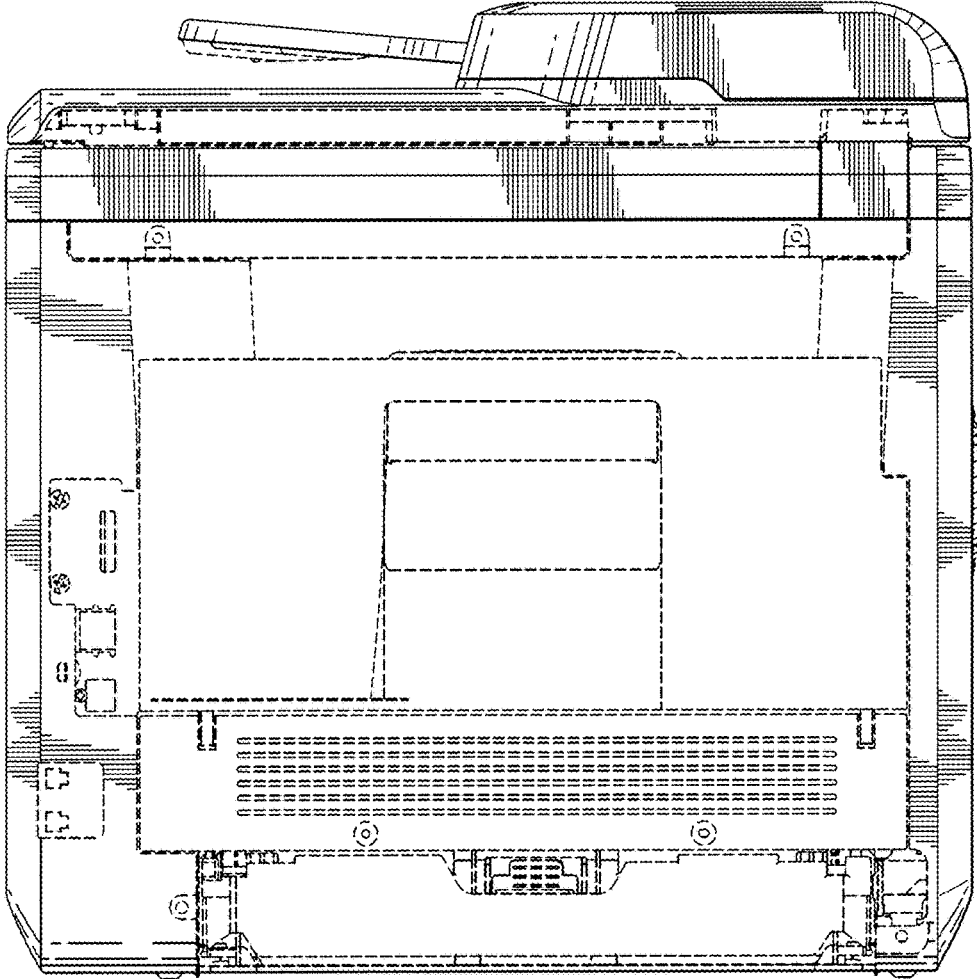

FIG.3

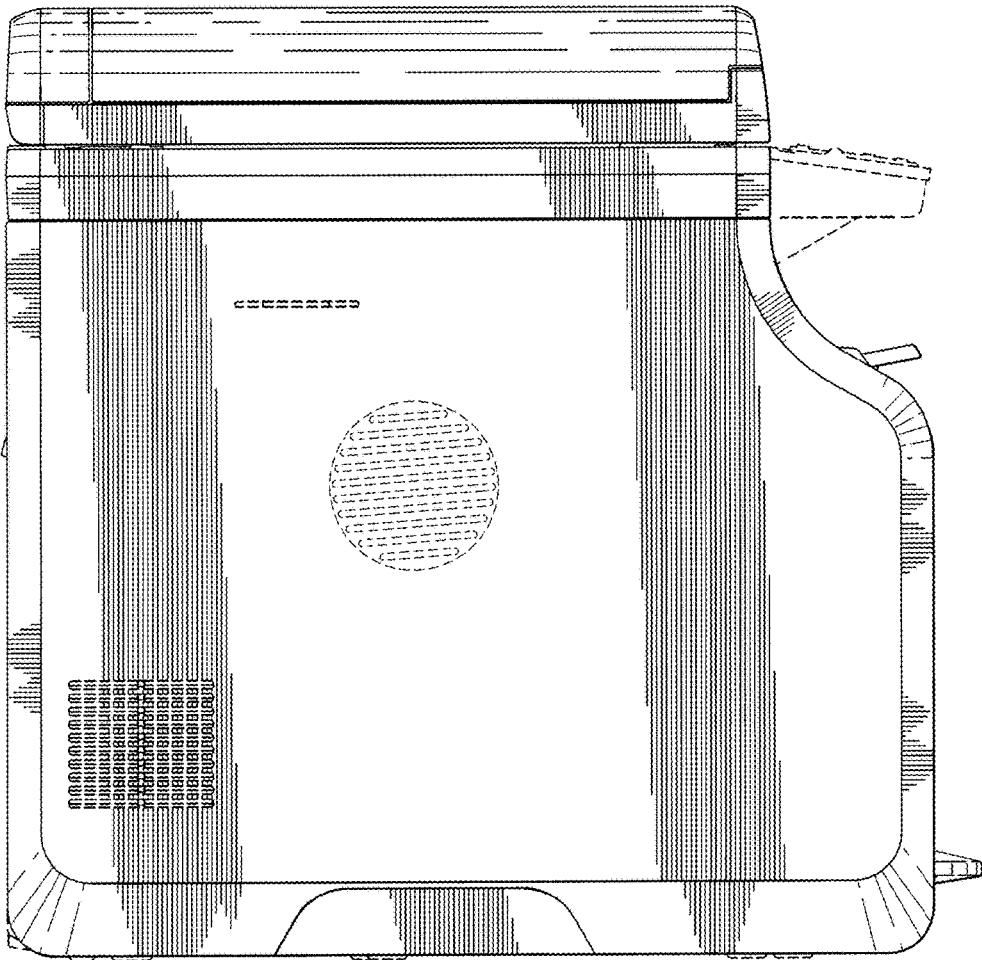

FIG.4

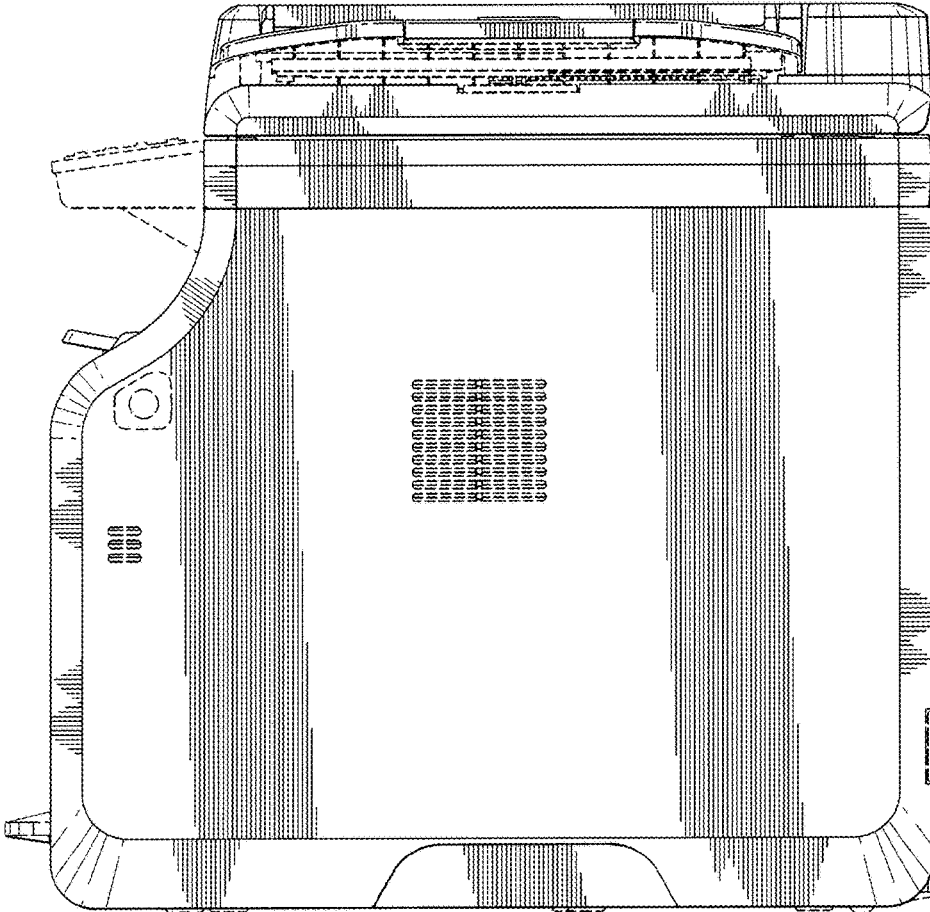

FIG.5

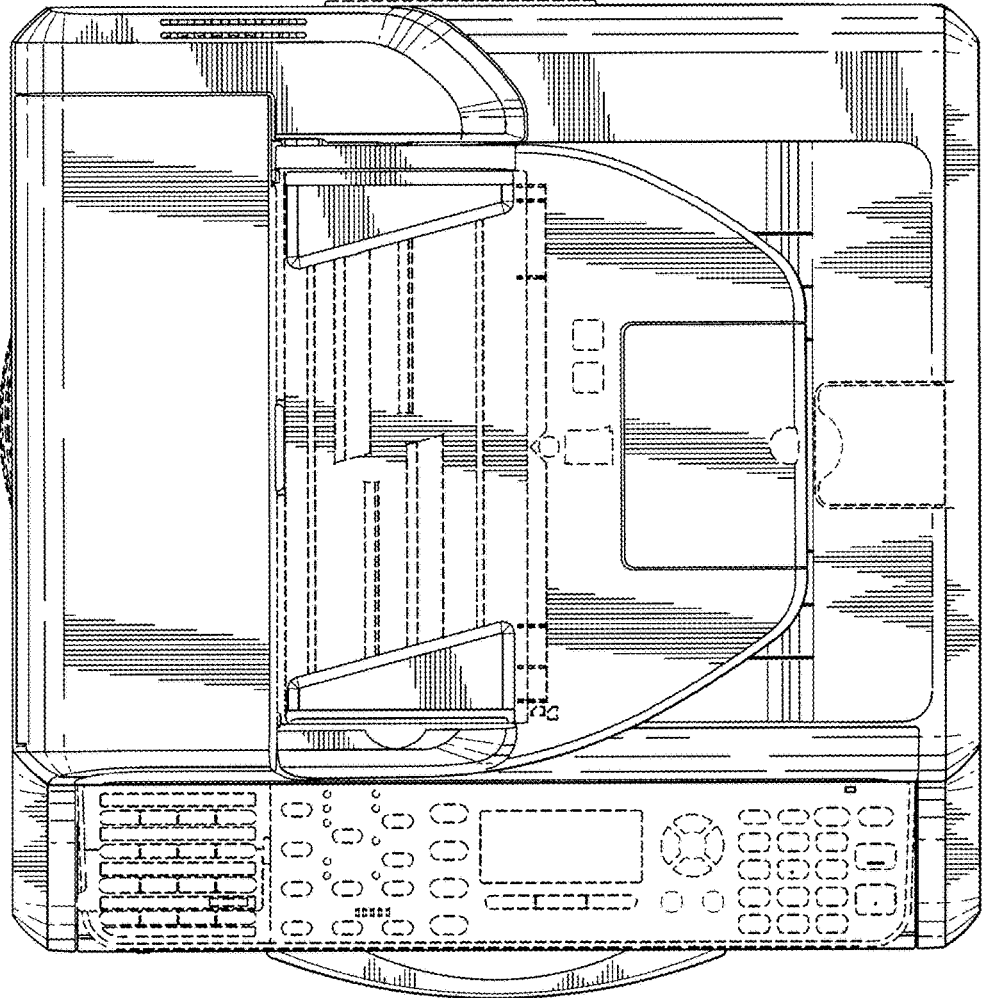

FIG. 6

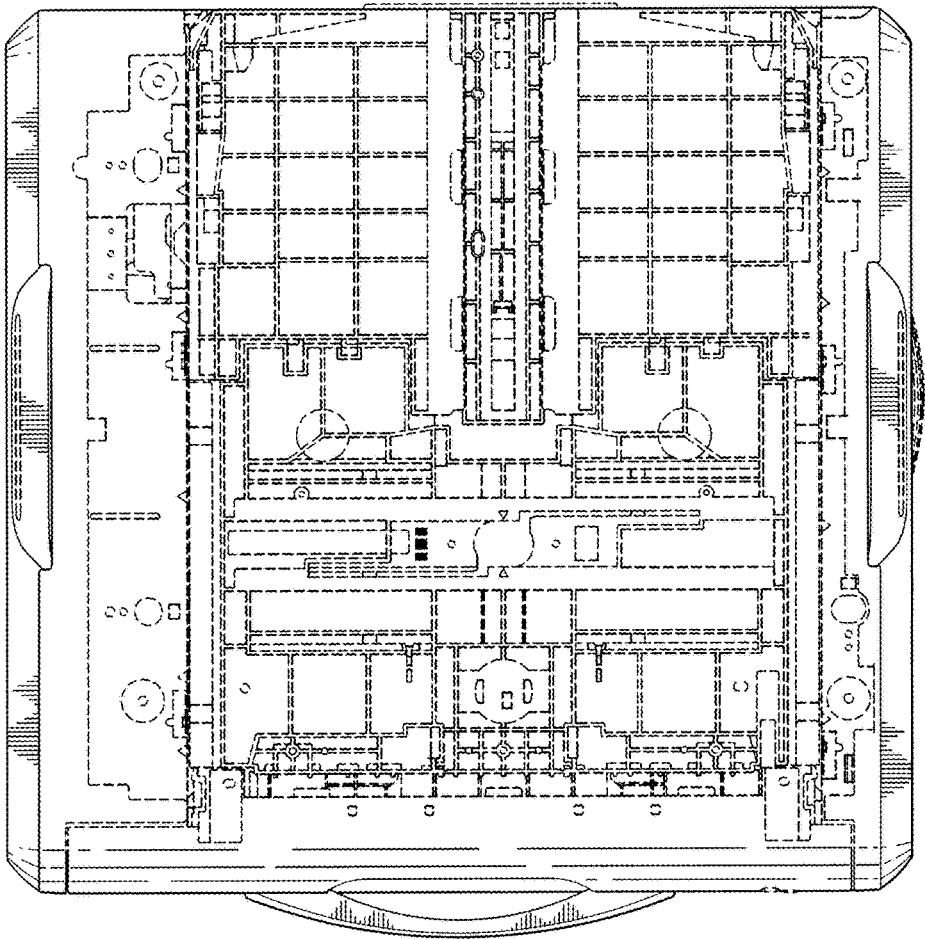

FIG. 7

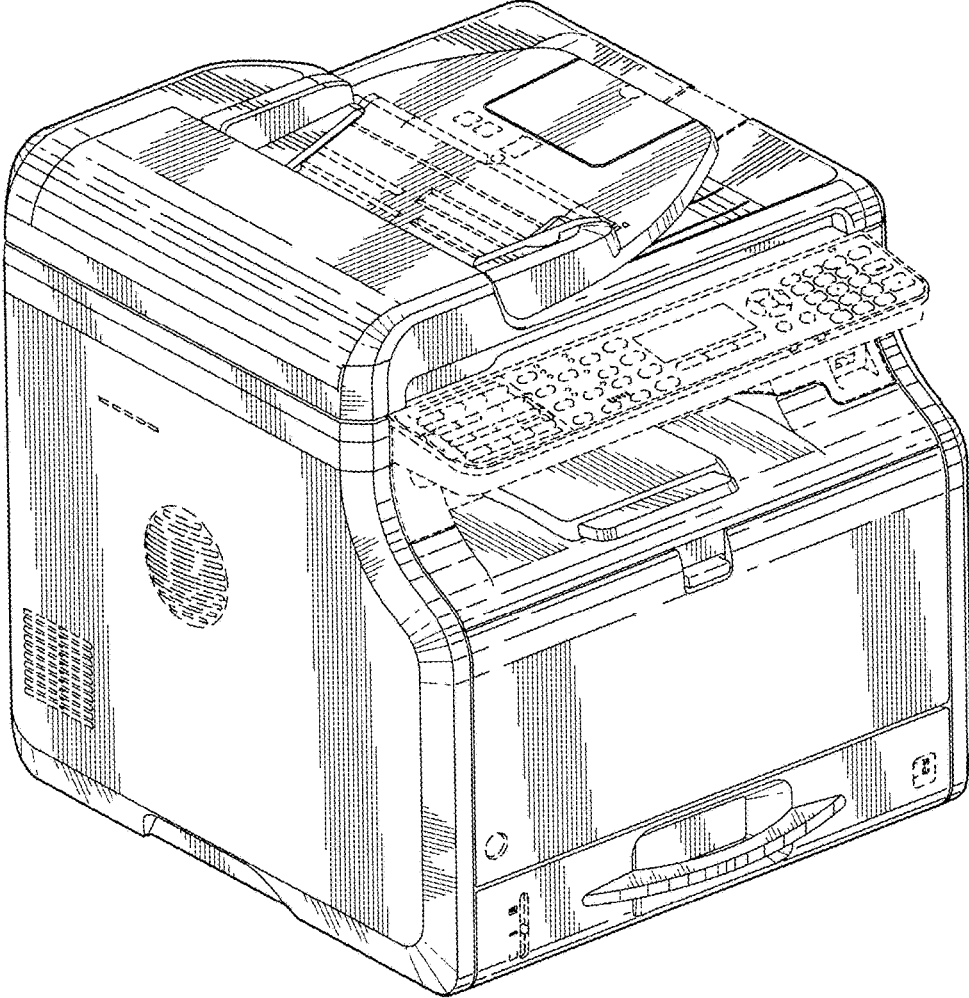

FIG.8

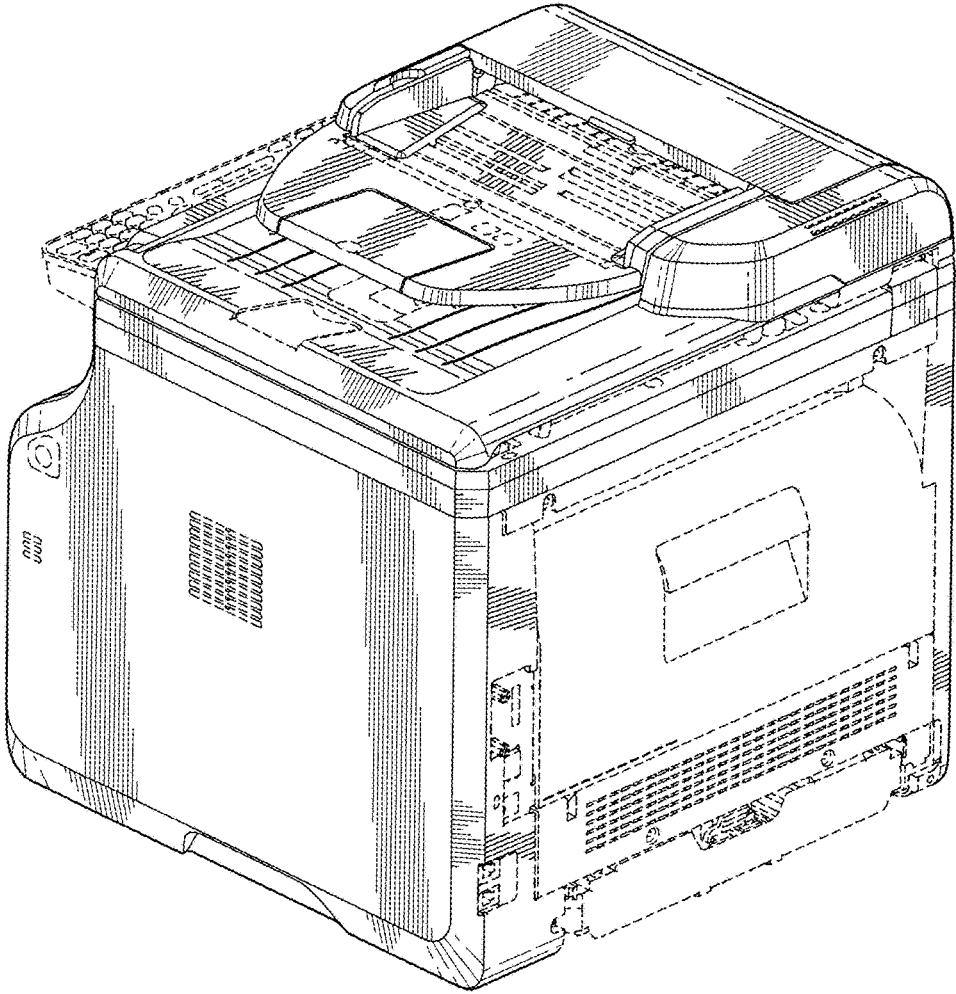

FIG. 9

