



US00D930236S

(12) **United States Design Patent**  
**Fornarelli**

(10) **Patent No.:** **US D930,236 S**

(45) **Date of Patent:** **\*\* Sep. 7, 2021**

(54) **VAPORIZER POD**

(71) Applicant: **14TH ROUND INC.**, Chicago, IL (US)

(72) Inventor: **Thomas Fornarelli**, Chicago, IL (US)

(73) Assignee: **14TH ROUND INC.**, Los Angeles, CA (US)

(\*\*) Term: **15 Years**

(21) Appl. No.: **29/687,581**

(22) Filed: **Apr. 13, 2019**

(51) **LOC (13) Cl.** ..... **16-02**

(52) **U.S. Cl.**

USPC ..... **D27/167**

(58) **Field of Classification Search**

USPC ..... D27/100, 101, 139, 141, 148, 157,  
D27/161-171, 183, 185-194; D13/108,  
D13/144, 103, 119, 146, 168; D23/360,  
D23/364-366; D24/110, 110.5, 129, 113,  
D24/112; D19/925-929, 161-166, 173,  
D19/66, 115, 123, 177, 923, 194-196;  
(Continued)

(56) **References Cited**

**U.S. PATENT DOCUMENTS**

D244,552 S \* 5/1977 Stringer ..... D27/154  
D300,331 S \* 3/1989 Horntrich ..... 401/202  
(Continued)

**FOREIGN PATENT DOCUMENTS**

CN 304350813 \* 11/2017  
CN 304594747 \* 4/2018  
(Continued)

*Primary Examiner* — Dana K Weiland  
*Assistant Examiner* — Mary Claire Ramirez

(74) *Attorney, Agent, or Firm* — Flener IP & Business Law; Zareefa B. Flener; Ayhan E. Mertogul

(57) **CLAIM**

The ornamental design for a vaporizer pod, as shown and described.

**DESCRIPTION**

FIG. 1 is front perspective view of a vaporizer pod showing a first embodiment of my new design;  
FIG. 2 is a front (and identical rear) elevational view of the first embodiment of the design of FIG. 1;  
FIG. 3 is a left (and identical right) side elevational view of the first embodiment of the design of FIG. 1;  
FIG. 4 is a left (and identical right) side elevational view of a second embodiment of the design of FIG. 1, wherein the second embodiment is otherwise identical to the first embodiment;  
FIG. 5 is a top plan view of the first embodiment of the design of FIG. 1;  
FIG. 6 is a bottom plan view of the first embodiment of the design of FIG. 1;  
FIG. 7 is a top plan view of the second embodiment of the design of FIG. 1, wherein the second embodiment is otherwise identical to the first embodiment;  
FIG. 8 is front perspective view of a vaporizer pod showing a third embodiment of my new design;  
FIG. 9 is a front (and identical rear) elevational view of the third embodiment of my new design;  
FIG. 10 is a left (and identical right) side elevational view of the third embodiment of my new design;  
FIG. 11 is a top plan view of the third embodiment of my new design;  
FIG. 12 is a top plan view of a fourth embodiment of my new design, wherein the fourth embodiment is otherwise identical to the third embodiment; and,  
FIG. 13 is a bottom plan view of the third embodiment of my new design.  
The broken lines in the drawings depict portions of the vaporizer pod that form no part of the claim.

**1 Claim, 9 Drawing Sheets**

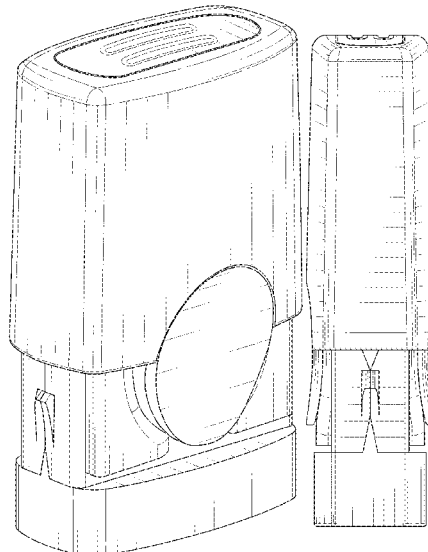

# US D930,236 S

(58) **Field of Classification Search**

USPC .... D28/85, 4, 7, 88, 73-76; D3/201, 11, 13,  
           D3/17, 273, 300, 202; D14/411, 480.5,  
           D14/480.1, 480.3, 483, 484.1, 137, 250,  
           D14/251, 480.7, 203.1, 203.3, 203.7, 218,  
           D14/254, 433-435, 435.1; D9/686, 529;  
           D8/107; D10/119.1, 119.3, 119.2;  
           D17/13  
 CPC ..... A24F 40/00; A24F 40/40; A24F 40/42;  
           A24F 40/05; A24F 40/46; A24F 47/002;  
           A24F 47/008; A24D 1/14; A24D 1/042;  
           A24D 1/02; G06F 3/03545; A61M 15/06  
 See application file for complete search history.

(56) **References Cited**

U.S. PATENT DOCUMENTS

D417,731	S	*	12/1999	Butler	.....	D24/110
D500,301	S	*	12/2004	Deguchi	.....	D14/480.4
D554,119	S	*	10/2007	Otsuka	.....	D14/480.5
D673,576	S	*	1/2013	Lin	.....	D14/480.7
D757,734	S	*	5/2016	Emami	.....	D14/480.7
D779,719	S	*	2/2017	Qiu	.....	D27/101
D818,636	S	*	5/2018	Qiu	.....	D27/101
D834,744	S	*	11/2018	Zhu	.....	D27/101
D836,831	S	*	12/2018	Cividi	.....	D27/162
D844,235	S	*	3/2019	Cividi	.....	D27/167
D849,996	S	*	5/2019	Duque	.....	D27/194
D866,852	S	*	11/2019	Cividi	.....	D27/101
D870,959	S	*	12/2019	Duque	.....	D27/162
D875,306	S	*	2/2020	Pan	.....	D27/167
D881,460	S	*	4/2020	Han	.....	D27/162

RE47,994	E	*	5/2020	Bowen	.....	H02J 7/0042
						D13/108
D887,632	S	*	6/2020	Duque	.....	D27/167
D902,473	S	*	11/2020	Li	.....	D27/101
D902,480	S	*	11/2020	Chen	.....	D27/194
D903,303	S	*	12/2020	Guo	.....	D3/209
D910,906	S	*	2/2021	Zhou	.....	D27/162
2015/0128967	A1	*	5/2015	Robinson	.....	A24F 47/008
						131/328
2016/0167846	A1	*	6/2016	Zahr	.....	A24F 47/002
						222/153.14
2018/0037381	A1	*	2/2018	White	.....	B65D 81/02
2019/0008208	A1	*	1/2019	Cirillo	.....	A24F 7/04
2019/0021396	A1	*	1/2019	Vo	.....	A24F 7/04
2019/0029319	A1	*	1/2019	Moorman	.....	A24F 7/04
2019/0037926	A1	*	2/2019	Qiu	.....	A24F 47/008
2019/0159519	A1	*	5/2019	Bowen	.....	A24F 40/40
2019/0373679	A1	*	12/2019	Fu	.....	A24F 7/00
2019/0380388	A1	*	12/2019	Amorde	.....	A24F 40/65
2020/0085104	A1	*	3/2020	Scatterday	.....	A24F 47/008
2020/0146361	A1	*	5/2020	Silver	.....	G16H 40/67
2020/0178616	A1	*	6/2020	Yu	.....	A61M 15/0083
2020/0288788	A1	*	9/2020	Vora	.....	A24F 40/40
2020/0315253	A1	*	10/2020	Legendary	.....	A61M 15/06

FOREIGN PATENT DOCUMENTS

CN	304631993	*	5/2018
CN	304733805	*	7/2018
CN	304773666	*	8/2018
CN	304827366	*	9/2018
CN	304942366	*	12/2018
EM	005270725-0002	*	6/2018

\* cited by examiner

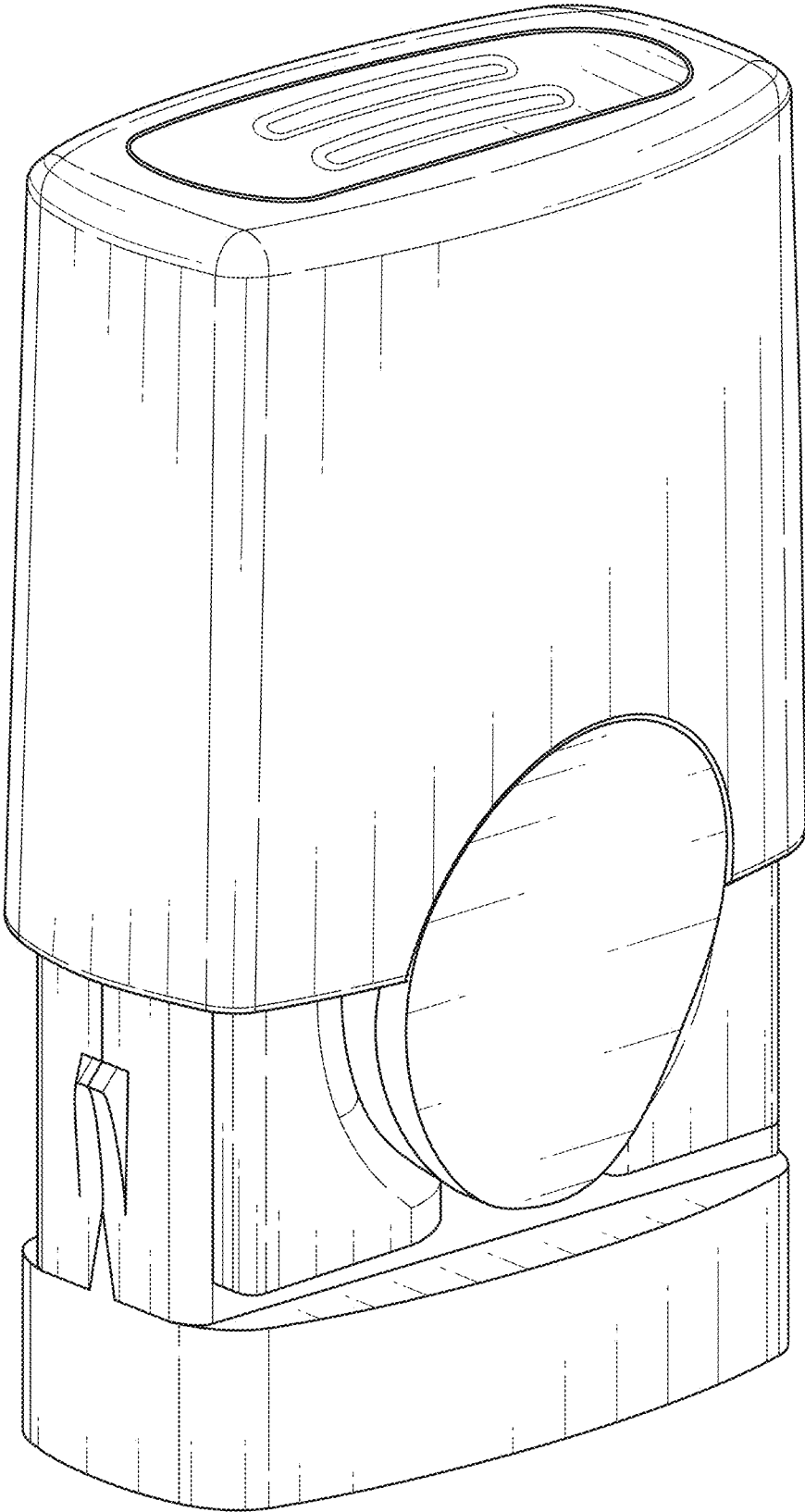

FIG. 1

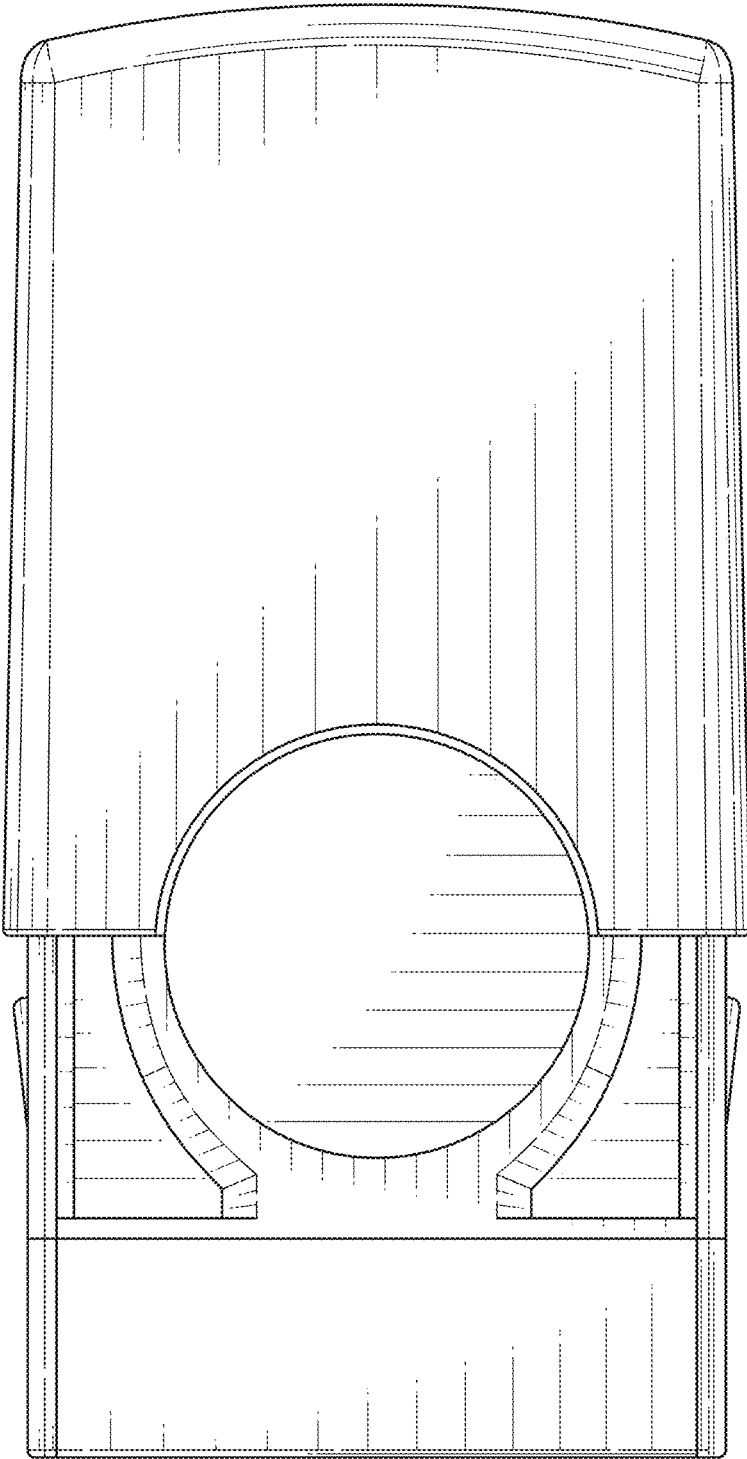

FIG. 2

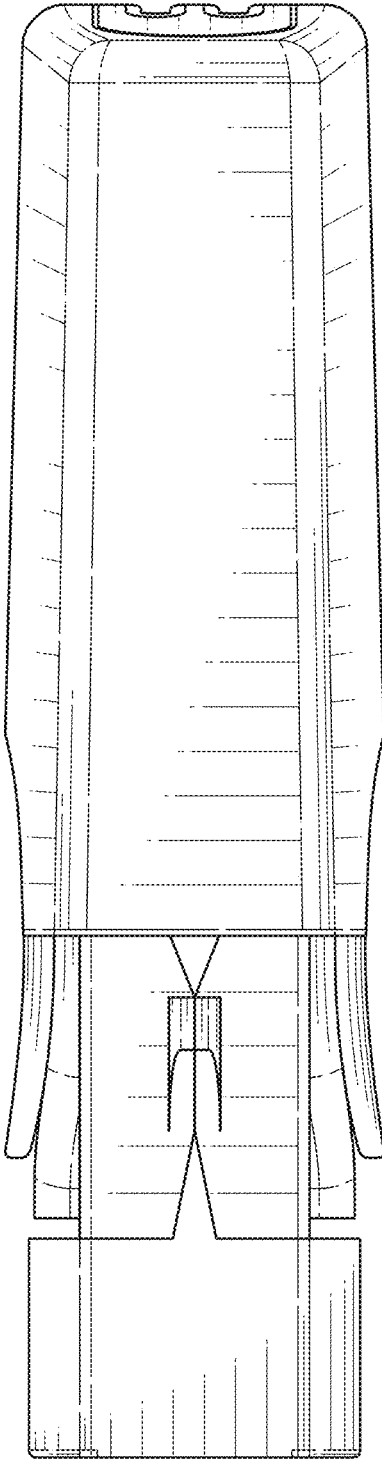

FIG. 3

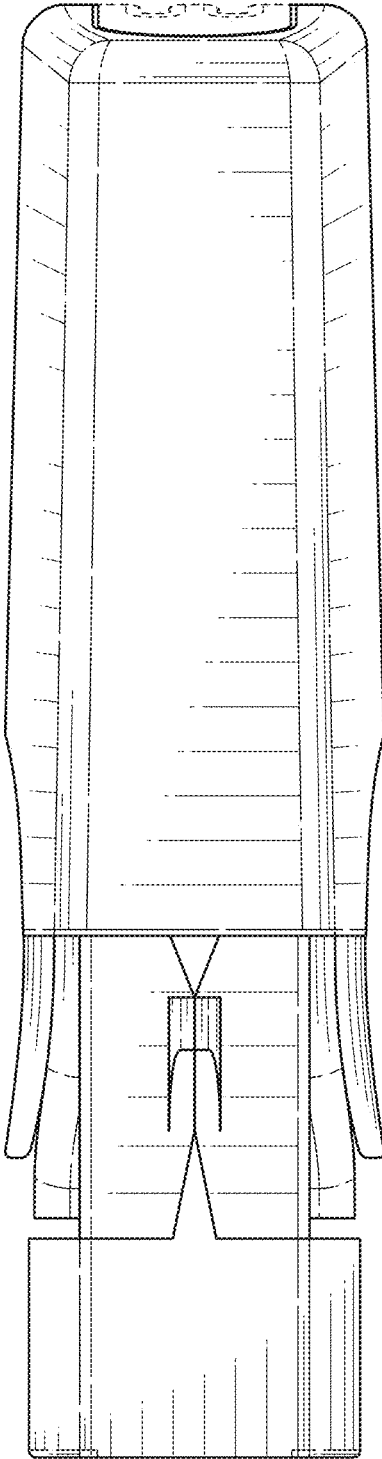

FIG. 4

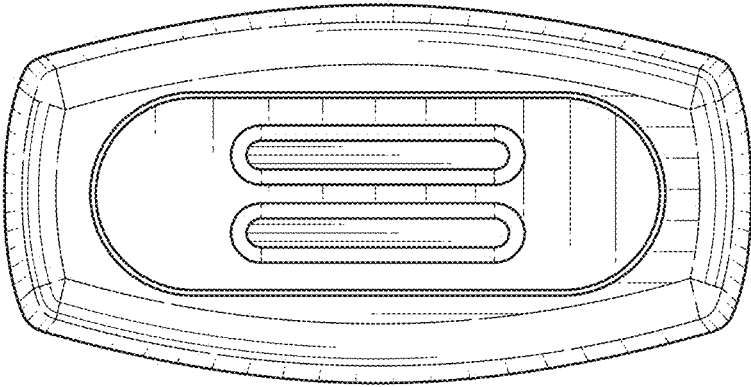

FIG. 5

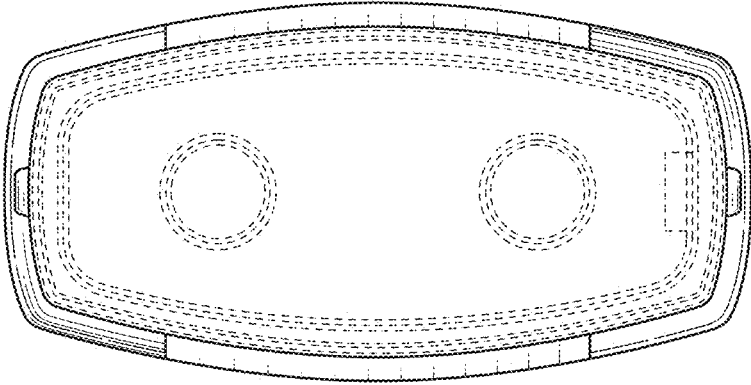

FIG. 6

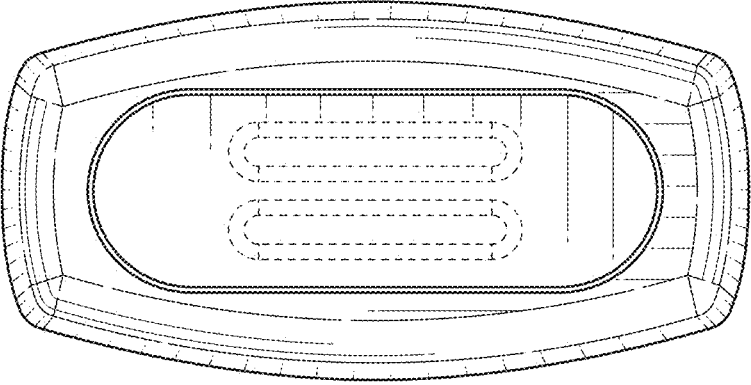

FIG. 7

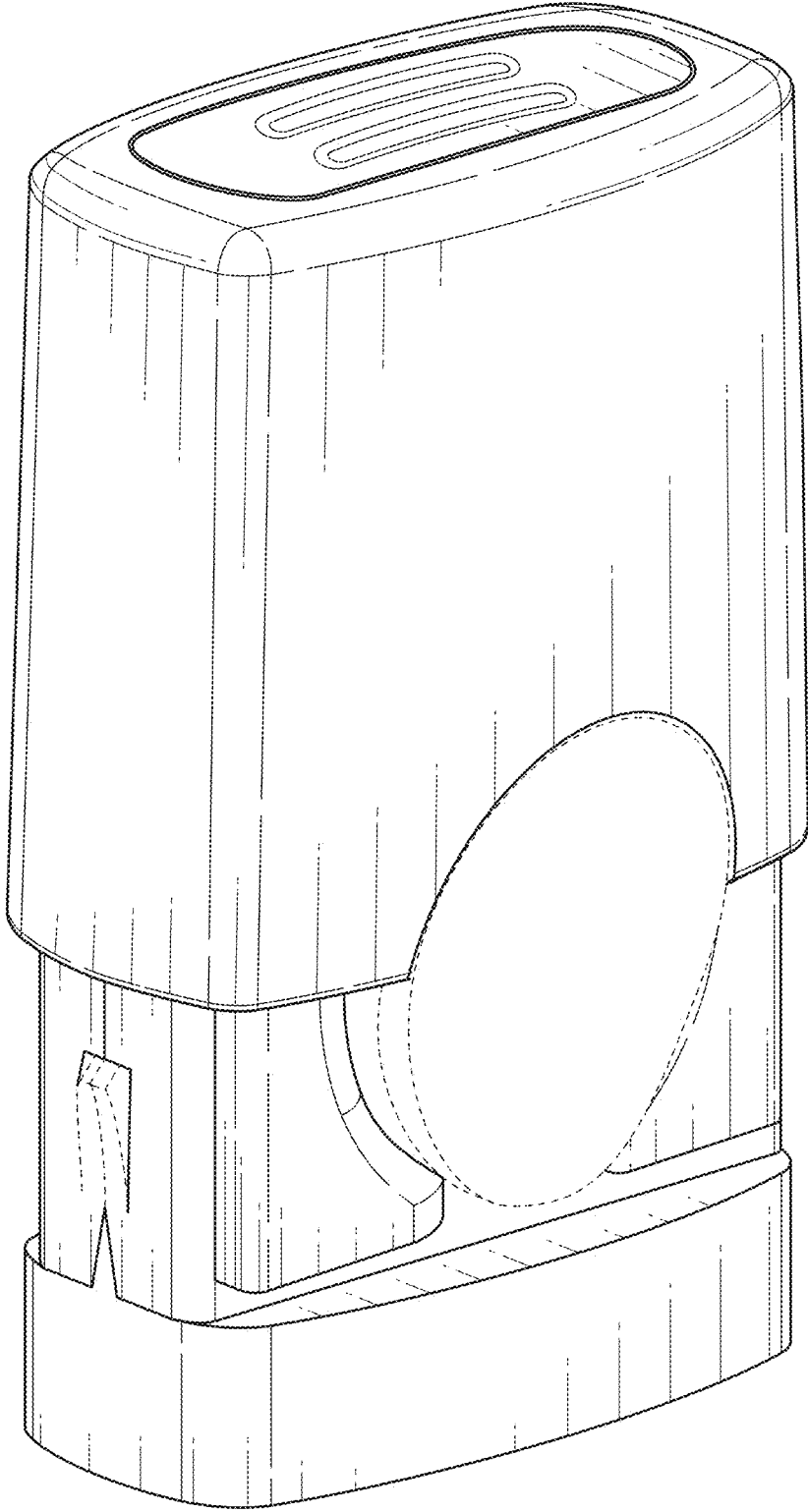

FIG. 8

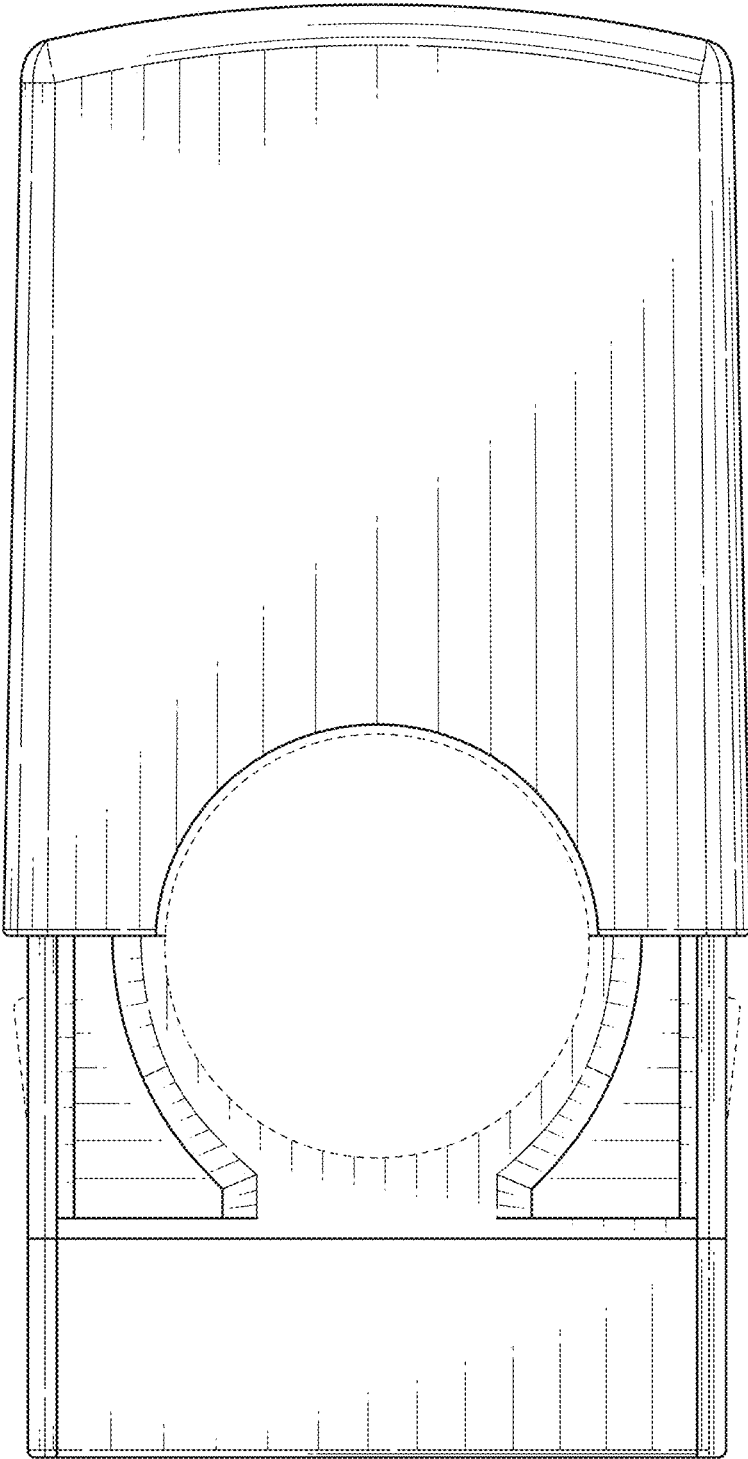

FIG. 9

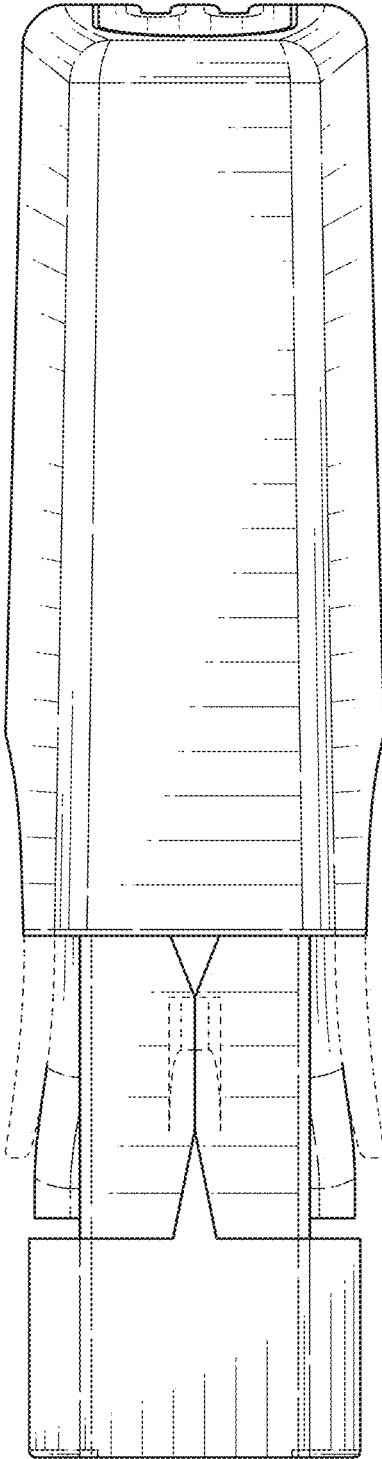

FIG. 10

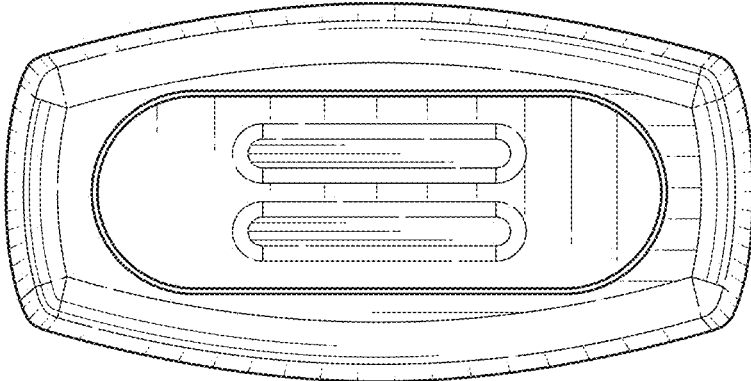

FIG. 11

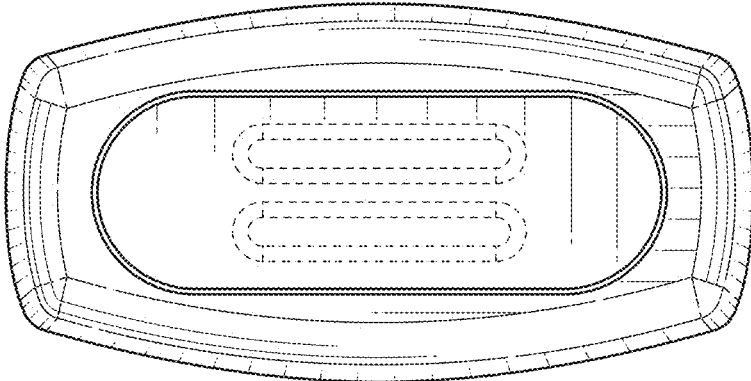

FIG. 12

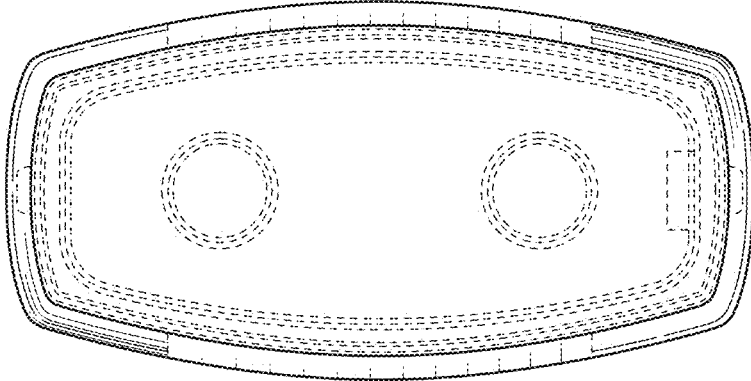

FIG. 13