

(19) World Intellectual Property
Organization
International Bureau



(43) International Publication Date
27 May 2004 (27.05.2004)

PCT

(10) International Publication Number
WO 2004/044664 A1

(51) International Patent Classification⁷: **G05B 15/00**,
H03K 17/94

(21) International Application Number:
PCT/US2003/035308

(22) International Filing Date:
5 November 2003 (05.11.2003)

(25) Filing Language: English

(26) Publication Language: English

(30) Priority Data:
60/424,557 6 November 2002 (06.11.2002) US

(81) Designated States (*national*): AE, AG, AL, AM, AT, AU, AZ, BA, BB, BG, BR, BY, BZ, CA, CH, CN, CO, CR, CU, CZ, DE, DK, DM, DZ, EC, EE, EG, ES, FI, GB, GD, GE, GH, GM, HR, HU, ID, IL, IN, IS, JP, KE, KG, KP, KR, KZ, LC, LK, LR, LS, LT, LU, LV, MA, MD, MG, MK, MN, MW, MX, MZ, NI, NO, NZ, OM, PG, PH, PL, PT, RO, RU, SC, SD, SE, SG, SK, SL, SY, TJ, TM, TN, TR, TT, TZ, UA, UG, US, UZ, VC, VN, YU, ZA, ZM, ZW.

(84) Designated States (*regional*): ARIPO patent (BW, GH, GM, KE, LS, MW, MZ, SD, SL, SZ, TZ, UG, ZM, ZW), Eurasian patent (AM, AZ, BY, KG, KZ, MD, RU, TJ, TM), European patent (AT, BE, BG, CH, CY, CZ, DE, DK, EE, ES, FI, FR, GB, GR, HU, IE, IT, LU, MC, NL, PT, RO, SE, SI, SK, TR), OAPI patent (BF, BJ, CF, CG, CI, CM, GA, GN, GQ, GW, ML, MR, NE, SN, TD, TG).

(71) Applicant and
(72) Inventor: **LIN, Julius** [US/US]; 108 Beverly St., Mountain View, CA 94043 (US).

(74) Agent: **MCCRISTLE, KELLY**; P.O. BOX 848, 2401 Carlmont Dr #17, Belmont, CA 94002 (US).

Published:
— with international search report

For two-letter codes and other abbreviations, refer to the "Guidance Notes on Codes and Abbreviations" appearing at the beginning of each regular issue of the PCT Gazette.

(54) Title: VIRTUAL WORKSTATION

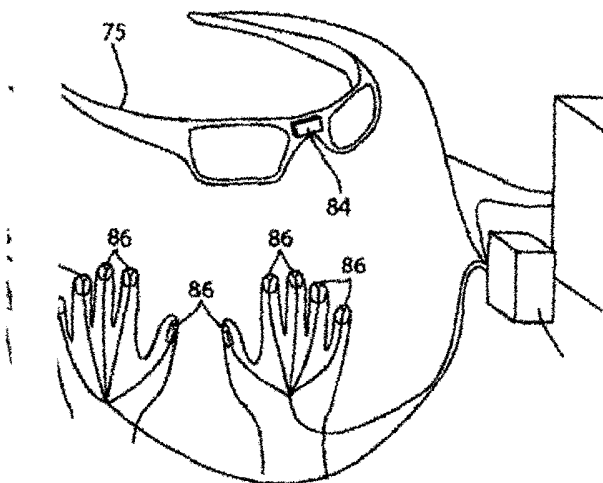

(57) Abstract: In accordance with The present invention there is provided devices and methods for controlling a microprocessor controlled device in a virtual environment through the use of at least one sensor disposed at least one user's finger and a scanner; said sensor and scanner being utilized to input position data, the method comprising the steps of: loading an operating system in a computing environment; displaying a virtual keyboard and a virtual pointing device on a display device; initializing coordinates defining individual keys of said keyboard; initializing coordinates defining a location of said pointing device in relation to the keyboard; monitoring the position of at least one sensor disposed on a user's finger; determining if sensor movement correlates to depression of

a key on the keyboard and providing feedback to the user to indicate that a key was depressed on the keyboard; transmitting data correlating to the depression of the key; and returning to the monitoring step.

WO 2004/044664 A1

VIRTUAL WORKSTATION**PRIORITY CLAIM**

[0001] The present invention claims priority to U.S. Provisional Patent application Serial Number 60/424,557 filed November 6, 2002, the entirety of which is hereby incorporated by reference.

TECHNICAL FIELD

[0002] The present invention is generally related to methods and devices for producing a virtual computing environment. More specifically, the present invention is related to methods and devices that in combination mimic the functionality and behavior of a physical computer system in a virtual environment. In particular the methods and devices in accordance with the present invention includes a portable computing system wherein the system is configured to provide the user with a virtual hardware environment that may be utilized for computing, gaming or other uses.

BACKGROUND OF THE INVENTION

[0003] With the advent of the modern computer input devices were invented to allow for the input of data, for example, early computer systems utilized punch cards to input data into the computer's memory. Although punch cards were effective at inputting data, a more simplified device was necessary, thus the modern keyboard was developed.

[0004] One of the most important factors contributing to the effective use of a computer is the interface between the computer and a person using it. Unquestionably the most popular computer interface device is the keyboard, which has a plurality of depressible keys each corresponding to a particular alphanumeric character, symbol, or computer function. While computer keyboards are widely accepted and quite suitable in many situations, keyboards are not always the most efficient, convenient, or easy to use devices.

[0005] A drawback of computer keyboards is that they include up to 110 individually marked keys mounted to a base with as many switches. All of these components must be produced and assembled, which accounts for considerable expense. Since keyboards are mechanical, are also more prone to failure than solid-state devices, additionally, due to the likelihood of failure, broken keyboards additionally present disposal problems. Further, the conventional keyboard cannot be quickly changed to a new keyboard layout, such as might be desired by those who have learned a keyboard layout other than the somewhat inefficient but traditional QWERTY layout.

[0006] Another drawback of computer keyboards is that they are built generally in one size for all users. As a result, users with relatively small or large hands must adapt to a keyboard size that is not optimal for their particular hand size. A person with smaller hands must stretch further to strike a key some distance from a home row of keys, whereas a person with larger hands will have a harder time accurately striking any desired key. Keyboard size that is optimized for a particular use may lead to decreased hand fatigue. However, keyboard manufacturers have determined an ergonomically acceptable compromise, which is a compromise nevertheless. Since keyboards are produced having only one size forces a user to type with his hands close together in an unnatural manner. It has been found that so called "split" keyboards, which are split into a separate keyboard for each hand, are more comfortable for the user and produce a slightly faster typing speed as a result. Additionally, as computers become more common in the workplace, a greater number of injuries have been reported due to utilizing a keyboard.

[0007] There have been attempts by various manufacturers to address the problems associated with mechanical keyboards. One such example is described in U.S. Patent No. 5,581,484, wherein there is described a finger mounted computer input device. The finger-mounted device utilizes a series of pressure sensors to determine a users hand movement which then corresponds to a key on a keyboard. A problem with this type of system is that the user must still physically interact with a surface to generate a signal. Additionally, the sensors are usually disposed on a glove, wherein the user wears the glove to utilize the system. A problem associated with glove-based systems is that the material from which the glove has been fabricated

has a fatigue life, and therefore will eventually wear out from prolonged usage. Additionally, a user may experience discomfort from using these types of gloves in that they may perspire inside the glove. The perspiration may further lead to degradation of the glove.

[0008] Another example of a virtual keyboard are produced by www.vkb.co.il, www.canasta.com, and www.virtualdevices.net. These types of keyboards utilize an infrared projection system, wherein a keyboard is projected onto a surface and a sensor detects the position of a finger on top of the projected keyboard image. A problem with these types of keyboards is that you can only utilize the system on a smooth clean non-transparent steady surface, additionally, if you rest your hands within the projected keyboard the sensor may interpret this motion as keystrokes, thereby resulting in errors. Further still, since the keyboard is projected onto the surface, the user may experience light interference from surrounding light sources.

[0009] Lastly, with the resurgence in tablet type computers having pressure sensitive screens, Microsoft® has released an on-screen keyboard in their latest version of Windows® that enables a user to utilize their fingers or a stylus to input data.

[0010] While each of these systems are a novel approach to overcoming the dependence on a physical keyboard, there are still shortcomings. Namely, each of the systems require the user to either be physically tethered to a computer, where pressure sensitive devices that must be depressed on a surface or find a smooth surface to set up a virtual keyboard. Additionally, these devices do not allow a user to customize the layout of the keyboard or adapt the keyboard to a user's specific style of typing. In addition to being tethered to a computer, the use of physical input devices may cause injury to the user. For example, many claims are filed every year for repetitive stress injuries incurred from keyboard usage. Examples of common injuries are carpal tunnel syndrome, eye fatigue, neck and back strain, many of which are attributed to usage of a personal computer.

[0011] Attempts have been made to eliminate the use of a keyboard as an input device entirely. Many manufactures have attempted to produce voice recognition software systems, wherein a user could speak every command to a computer thereby eliminating the need for a physical or virtual keyboard. While this approach may be novel, presently voice recognition software has not advanced to the point of being reliable enough to replace a keyboard. In addition to requiring more hardware, a microphone, the voice recognition software is always running within a computer's operating system, thus requiring additional computing power. Also, voice recognition software must be custom tailored to each user's voice, inflections and/or accents, therefore once a system has been customized to an individual user other user's cannot readily utilize the system. Another shortcoming of voice recognition systems is that it is difficult to use voice recognition for editing, browsing the Internet, graphic design and similar input intensive programs. Additionally, constant talking may fatigue the user's voice, wherein the user's pitch and tone may change, thereby leading to additional input errors because the voice recognition software no longer recognizes the user's voice. Further still, voice recognition systems cannot be utilized in cubicle type work environments or similar "open" type environment where noise interference from other voices may confuse the voice recognition software.

[0012] Additional input devices may also be utilized in conjunction with keyboards. For example, pointing devices, such as "mouse" pointing devices and so called "track ball" devices are also popular computer interfaces. Generally, these types of devices provide velocity information, in both an X direction and an orthogonal Y direction, to the computer, as well as signals from one or more momentary contact push buttons. A pointing icon or other "tool" on a computer monitor responds to such velocity input by corresponding X and Y movement on the computer monitor. Graphics tablets are another type of "pointing" input device that provide the computer with X and Y positional information, as opposed to velocity information, which is used in much the same manner by the computer. Such devices are well suited for pointing to various software "push button" options on the screen, selecting portions of text or a group of software "objects," freehand on-screen drawing, positioning a typing cursor location, and similar functions. However, such pointing devices are remarkably ill suited for text data input.

[0013] Other types of computer interfaces have been developed to overcome some of the above-mentioned drawbacks. For example, U.S. Pat. No. 5,212,372 to Quick et al. on May 18, 1993, teaches a glove device that has sensors for measuring the curvature of each finger at joints thereof. For entering numerical data, a person using this type of device curves his fingers to point to "zones," or virtual keys, that each represents a particular number. While the input of alphabetical data is mentioned in the Quick disclosure, only numerical zones are illustrated and it remains unclear how such a device could possibly be used to enter the twenty-six additional characters of the alphabet, especially since the little finger is used solely for designating an "enter" key and is therefore not available for pointing to alphanumeric zones.

[0014] A variety of similar glove-based prior art devices exist, and in most cases each uses some type of joint flexing sensor to determine finger curvature. Many such devices are designed for communication with deaf or otherwise challenged individuals, and typically provide for computer interpretation of alphanumeric data formed by a single hand with standard sign language. It is a slow and fatiguing process for people, even those fluent in sign language, to use such devices to enter a large amount of data into a computer, such as might be required while typing a patent disclosure, for example. Further, while finger curvature is relatively easy to detect in a variety of sophisticated ways, such detection is only accomplished in one dimension. Lateral movement of the finger, for example from the "J" key to the "H" key of a standard QWERTY keyboard, cannot be detected by such joint flexure sensors as disclosed in the prior art. This drawback is also evident in many "virtual reality" data manipulation gloves, which also include a variety of motion sensors on similar gloves. As a result, such devices have limited use and are not well suited for prolonged data entry from a wide selection of character and command keys, such as those found on the standard computer keyboard. As previously described, these gloves are generally fragile and are not constructed for constant everyday usage. Additionally, the gloves are particularly sensitive to moisture such as sweat from the users hands or a wet environment, wherein moisture may cause sensor problems or lead to eventual failure of the glove.

[0015] Therefore there is a need for a device that eliminates the shortcomings of the presently available input devices, wherein the device may be utilized by a user in any physical configuration without requiring the user to remain physically limited by the device. Such a needed device would be adaptable to any individual, regardless of hand size or typing style. Further, such a needed device could be used equally well for both alphanumeric data entry, command entry, and position/velocity input. Such a needed device would be to a large extent software re-configurable, making use of the device immensely flexible and adaptable. The present invention fulfills these needs and provides further related advantages.

[0016] These and other objects, advantages, and features of the invention will become apparent to those persons skilled in the art upon reading the details of the methods and systems of the present invention, which are more fully described below.

SUMMARY OF THE INVENTION

[0017] The present invention provides systems and methods for interaction within a virtual environment. Wherein the methods of the present invention may be utilized to virtually interact with a computer system through the use of virtual input devices, wherein the methods and systems allow a user to input data into a computing system without physical limitations.

[0018] In accordance with the present invention there is provided a method for controlling a microprocessor based system in a virtual environment, the method comprising: loading a computer program into a memory space; transmitting at least one signal from at least one transmitter; displaying virtual input devices on a display device, wherein the virtual input devices initially have pre-determined coordinates; receiving data generated from movement of at least one sensor; calculating coordinates of the sensor movement; comparing calculated coordinates to the pre-determined coordinates of each virtual input device; calculating desired input from coordinates generated by the sensor movement; and displaying input on the display device and transmitting the input to the operating system.

- [0019] In accordance with another embodiment of the present invention there is provided a method for controlling a microprocessor controlled device in a virtual environment, the method comprising: loading a computer program into a memory space; loading an operating system into a memory space; transmitting at least one signal from a transmitting device displaying a virtual keyboard and a virtual input device on a display device; initializing coordinates defining individual keys of the keyboard; initializing coordinates defining a location of the input device in relation to the keyboard; receiving data at least one sensor wherein the data received is converted into coordinate information and stored in a memory space; determining if coordinated derived from movement correlates to a key location of the virtual keyboard or movement of the virtual input device; and displaying sensor movement on the display device.
- [0020] In accordance with the present invention there is provided a method of generating and controlling a virtual workstation, the method comprising: initializing an operating system and a controller system in a microprocessor based computer system; displaying virtual hands, a virtual keyboard, a virtual pointing device and a virtual workstation environment on a display device; monitoring movement of sensors disposed on a user's hands for movement; displaying movement of the virtual hands in response to movement of the sensors; and determining if movement of at least one sensor passes a user defined threshold.
- [0021] In accordance with the present invention there is provided a method of generating a virtual gaming system, the method comprising: initializing an operating system and a controller system in a microprocessor based computer system; loading a game program into a memory space; displaying a virtual player on a display device; monitoring movement of sensors disposed on a user for movement; and displaying movement of the virtual player in response to movement of the sensors.
- [0022] In accordance with the present invention there is provided a system for virtually controlling a microprocessor based system, the system comprising: a microprocessor based computer system having an operating system configured to be run thereon; a display device, at least one tracking device; at

least one sensor, wherein said tracking device is configured to track movement of said sensor and determine coordinates of said sensor and time components of sensor movement within a pre-defined area; and a software component, wherein said software is stored in a computer readable medium, wherein said software is in communication with said tracker and said display device, wherein said software determines vector movement and acceleration of said sensor and displays said sensor movement on said display device.

[0023] In accordance with the present invention there is provided a system for implementing a virtual reality environment, the system comprising: a display device associated with a user, the display device being responsive to image data for generating and displaying an image simulating a physical computer system, including a physical keyboard, a physical input device, and physical representation of the user's hands, wherein each of the simulated components appear to the user to be in space independent of actual physical objects; an output device for transmitting a signal; an input device for generating data in response to interaction with the signal; a processor connected to the input and output device and the display device and operating a virtual environment manager program and a multi-dimensional basic input and output program for generating a virtual keyboard, a virtual input device, and virtual hands, the processor being responsive to data generated from the input device, for generating motion image data corresponding to the input device data; and wherein the display device is responsive to motion image data for generating a second image simulating physical motion of at least one virtual component.

[0024] In accordance with the present invention there is provided a system for implementing a virtual reality (VR) computing environment, the system comprising: VR display device including at least one display and worn by a user the one display viewable by the user, with the VR display, responsive to first image data, for generating and displaying a first VR image simulating a physical computer system including a virtual keyboard having a plurality of physical keys, a virtual mouse having at least one physical button, with the first VR image representing the VR keyboard and VR mouse, the VR keyboard and VR mouse having a first appearance corresponding to the first image data; an input and an output device for generating motion-

representative data corresponding to motion of a user's body part; and a processor connected to the VR display device and operating a virtual environment manager (VEM) and multi-dimensional basic input/output subsystem(MD-BIOS) program, wherein the VEM and MD-BIOS provide the first image data to the VR display device, the processor being responsive to the motion-representative data generated from the input device, for generating motion image data corresponding to the motion; and wherein the VR display device is responsive to the motion image data for generating a second VR image simulating motion corresponding to the motion of the portion of the body of the user.

[0025] In accordance there is a need for smaller input/output interfaces as miniaturized portable computing devices become more common.

[0026] There is also a need for a system that recreates a full desktop computing experience without requiring the space needed for a full desktop computer or physically limiting a user to a physical location to utilize such a system.

[0027] There is an additional need for a system that can be utilized to minimize computer related injuries such as repetitive stress injury, carpal tunnel injuries and other such injuries that are related to physical computer use.

[0028] There is also a need for a system that is capable of displaying true three dimensional real world human-machine interactions.

[0029] It is the applicant's belief that the present invention addresses these needs with novel software and hardware solutions as described in detail below.

BRIEF DESCRIPTION OF THE FIGURES

[0030] To facilitate understanding, the same reference numerals have been used (where practical) to designate similar elements that are common to the Figures. Some such numbering has, however, been omitted for the sake of drawing clarity.

- [0031] Figure 1 is a block diagram illustrating exemplary mechanical devices that may be utilized with the methods in accordance with the present invention.
- [0032] Figure 2 is an exemplary embodiment of a computer system in accordance with the methods of the present invention.
- [0033] Figure 3 is an exemplary block diagram of the tracker system in accordance with the present invention.
- [0034] Figure 4 is an exemplary embodiment of the system in accordance with the present invention.
- [0035] Figure 5 is an exemplary embodiment illustrating an alternative embodiment of a display device in accordance with the present invention.
- [0036] Figure 6 is an exemplary embodiment of an alternative display device in accordance with the present invention.
- [0037] Figure 7 is an exemplary embodiment of a user's hand illustrating the wireless communication of the tracker system.
- [0038] Figure 8 is a functional flow diagram illustrating the method in accordance with the present invention.
- [0039] Figure 9 is a functional flow diagram illustrating the interaction between the software and hardware components of the present invention in accordance with the methods of the present invention.
- [0040] Figure 10 is a block diagram illustrating an exemplary embodiment of the memory structure of the multi-dimensional basic input/output system in accordance with the present invention.
- [0041] Figure 11 is a block diagram illustrating the threshold values and calculation methods of the virtual workstation manager in accordance with the present invention.

- [0042] Figure 12 is a functional flow diagram illustrating the method steps in accordance with the present invention.
- [0043] Figure 13 is an exemplary embodiment of a virtual workstation environment as seen from a user's perspective, wherein a virtual keyboard is shown disposed three dimensionally over a virtual mouse.
- [0044] Figure 14 is an exemplary embodiment of a virtual workstation environment as seen from a user's perspective, wherein the virtual mouse is shown disposed three dimensionally over the virtual keyboard.
- [0045] Figure 15 is a functional flow chart illustrating hardware components of a virtual car control center.
- [0046] Figure 16 is an exemplary embodiment of the present invention wherein the virtual environment manager has been configured as a virtual car control system.
- [0047] Figure 17 is an exemplary embodiment of the high-level virtual buttons in accordance with the virtual car control system.
- [0048] Figure 18 is an exemplary embodiment illustrating the high-level virtual buttons and the second level of virtual buttons in accordance with the virtual car control system.
- [0049] Figure 19 is an exemplary embodiment illustrating the high-level virtual buttons, the second level, and third level of virtual buttons in accordance with the virtual car control system.
- [0050] Figure 20 illustrates exemplary embodiments of additional second level virtual buttons after selection of the high-level virtual button.

DETAILED DESCRIPTION OF THE PREFERRED EMBODIMENTS

[0051] Before the present invention is described in such detail, it is to be understood that this invention is not limited to particular variations set forth herein as various changes or modifications may be made to the invention described and equivalents may be substituted without departing from the true spirit and scope of the invention. In addition, many modifications may be made to adapt a particular situation, material, composition of matter, process, process act(s) or step(s) to the objective(s), spirit or scope of the present invention. All such modifications are intended to be within the scope of the claims made herein.

[0052] Methods recited herein may be carried out in any order of the recited events that are logically possible, as well as the recited order of events. Furthermore, where a range of values is provided, it is understood that every intervening value, between the upper and lower limit of that range and any other stated or intervening value in that stated range is encompassed within the invention. Also, it is contemplated that any optional feature of the inventive variations described may be set forth and claimed independently, or in combination with any one or more of the features described herein.

[0053] All existing subject matter mentioned herein (*e.g.*, publications, patents, patent applications and hardware) is incorporated by reference herein in its entirety except insofar as the subject matter may conflict with that of the present invention (in which case what is present herein shall prevail). The referenced items are provided solely for their disclosure prior to the filing date of the present application. Nothing herein is to be construed as an admission that the present invention is not entitled to antedate such material by virtue of prior invention.

[0054] Reference to a singular item, includes the possibility that there are plural of the same items present. More specifically, as used herein and in the appended claims, the singular forms "a," "and," "said" and "the" include plural referents unless the context clearly dictates otherwise. It is further noted that the claims may be drafted to exclude any optional element. As such, this statement is intended to serve as antecedent basis for use of such exclusive terminology as "solely," "only" and the like in connection with the recitation of

claim elements, or use of a "negative" limitation. Last, it is to be appreciated that unless defined otherwise, all technical and scientific terms used herein have the same meaning as commonly understood by one of ordinary skill in the art to which this invention belongs.

[0055] Referring to the detail drawings and the disclosure herein, the term "keyboard" is defined herein to include alphanumeric keyboards, subsets of alphanumeric keyboards, keypads including numerical keypads, telephone and DTMF keypads, security access input devices using buttons and labels, etc., and so it not limited to QWERTY alphanumeric keyboards. Accordingly, it is understood that the use of the term "keyboard" and the depiction in any of the figures of a keyboard such as a QWERTY alphanumeric keyboard typically used with personal computers and the like is only an example of a keyboard for use, interaction, and operation by a user for any application of keyboards for input and/or output devices. As defined herein, the term "keyboard" is more than a plurality of keys, since a keyboard includes a layout of the plurality of keys as well as keys, with the layout typically being predetermined. The keys may be associated with symbols such as alphabetical, numerical, mathematical, or other representations, and the keys may include associated pictorial or symbolic representations thereupon. Accordingly, a keyboard is not identical to a set of buttons but may be a plurality of buttons having a layout and a set of symbols associated with each key or button.

[0056] The term "virtual reality" and its abbreviation "VR" are herein defined to include, but not limited to, visual and/or other sensory applications implemented using software and/or hardware to simulate and/or provide representations of environments which may be different from the physical environment of the user. Such VR may provide visual and/or multimedia zones, worlds, and work areas in which the user and/or other software applications may change and interact representations of elements in the VR environment. For example, in a VR world, a graphical representation of a switch may be changed to represent the flicking or switching of the switch, which may have an associated switch-flicking sound, which is activated by flicking the switch. In addition, the VR switching of the VR switch may cause the actuation of other events, either in the VR world or in actual physical

devices and structures; for example, the flicking of the VR switch may cause an actual computer to be turned on or off. Accordingly, the term "virtual reality" is not limited to simulations or representations of VR devices and information in VR worlds, but may also be extended to physical devices as well as, in hybrid implementations, to both physical and VR devices.

[0057] In accordance with the present invention, the detail description of the present invention will be divided into sections, wherein each section will be utilized to described components of the present invention. It shall be understood that the examples described herein should not be considered limiting in any manner and should be considered exemplary.

[0058] In accordance with the present invention there is provided devices, systems and methods for providing a human interface device that may be utilized to simulate a virtual environment. The human interface device includes hardware components consisting of a tracker assembly, a processing unit, and a display device. The software/firmware components comprise a virtual environment manager (VEM) and a Multi-Dimensional Basic Input/Output subsystem (MD-BIOS), wherein the software and hardware components are utilized in combination to provide a virtual environment. Examples of applications of the present invention include a virtual workstation environment (VWE) wherein a physical computing system is simulated in a virtual environment including virtual hands and virtual input devices such as a keyboard, pointing device or other similar input devices. Another contemplated application for the present invention is a virtual gaming system (VGS) wherein the present invention could be utilized to simulate a gaming environment wherein the user could virtually interact within the game. The above examples are to be considered to be merely exemplary in that the present invention may be utilized in many other applications such as military use, flight simulation/training, corporate meetings, etc.

[0059] The present invention will now be described in greater detail below with regard to the system's individual components.

Hardware

[0060] In accordance with the methods of the present invention there will be disclosed hardware devices that may be utilized in accordance with the methods of the present invention. It shall be understood that many of the hardware components are described in a general sense and that many other types/styles of similar hardware devices may be substituted for those described herein. For example, as described in the present invention a computer system may be embodied as an Intel® central processor unit (CPU) based system a RISC based processor system, though it shall be understood that this should not be considered limiting in any manner in that a computer system for use with the present invention may be based on similar microprocessor devices.

[0061] Referring now to Figure 1, there is shown an exemplary embodiment of hardware components in accordance with the present invention. As shown in Figure 1, the hardware components comprise a microprocessor based computer system, a display device, and a tracking system. In addition to the hardware shown, the present invention further includes software running stored in a computer readable medium, wherein the software is in association with the hardware components of the system. The software of component of the present invention will be described in greater detail below in reference to the methods of the present invention.

[0062] As shown in Figure 2, the microprocessor based computer system 10 includes a central processing unit 20, memory 30, a communication bus 40, a computer readable storage device 50 such as an optical storage device, magnetic storage device, flash memory storage device or similar computer readable storage mediums, and at least one communication port 60. The communication port 60 comprise any one of the following types of communication ports as well as a combination thereof: universal serial bus (USB), IEEE1394 (firewire), serial port, parallel port, infrared port, 802.11b, 802.11a, 802.11g, Bluetooth® or similar communication ports and devices.

[0063] Referring now to Figure 3, there is shown an exemplary embodiment of the tracker system 80 in accordance with the present invention. The

device or third transmitting device. The second or third transmitting devices may be configured to transmit acoustical, optical, or electromagnetic signals. As will be described in greater detail in the methods section, the system in accordance with the present invention may be configured to automatically choose between the two transmitters or the system may be manually configured. For example, if the user were to utilize the system in an environment having a large amount of stray magnetic fields that may interfere with the magnetic tracker, the system in accordance with the present invention may automatically switch to one of the other transmitting devices.

[0067] The transmitter 84 is configured to transmit at least one signal. The transmitted signal may be electromagnetic, optical, acoustical, inertial etc. in a generally defined field of view. For example, the transmitting device may be configured to transmit a signal in a field of view having a spherical radius of between about 0 to 360 degrees, more preferably between about 0 and 270 degrees and most preferred between about 0 and 180 degrees. It shall be understood that although the present invention has been described as including only a single transmitting device shall not be considered limiting in any manner and that it is contemplated that additional transmitting devices may be utilized with the present invention to further expand the field of view of the transmitting device and or to increase accuracy and functionality.

[0068] Referring now to Figure 4, there is shown an exemplary embodiment of the hardware components of the present invention in use. As shown in Figure 4 the computer system 10, display device 75, and the tracker system 80, wherein the tracker system 80 comprises the transmitter 84, SEU 82 and sensors 86. In a preferred embodiment the computer 10 is configured to be embodied in the form of a wearable computer system. Examples of preferred computer systems would be based on the Pocket PC® platform developed by the Microsoft® corporation. Although a Pocket PC platform is described as a preferred embodiment this shall not be considered limiting in any manner. It is contemplated that a user may be tethered to a conventional desktop computer system either wired or wirelessly or utilize other computer systems such as an Intel® or AMD® powered computing system, PalmPilot® or other similar computing devices.

[0069] Referring now to Figure 4, there is shown one embodiment of an display device 75 in accordance with the present invention. As shown in Figure 4, the display device 75 may be configured to include the transmitter 84 of the tracker system 80. In one embodiment the transmitter 84 is configured to be retained on the display device 75. The display device 75 in a preferred embodiment is a liquid crystal display (LCD) device, wherein the LCD device is in communication with the computer system 10 through the use of a wired or wireless connection (not shown). In alternative embodiments, the display device 75 may comprise other types and styles of head mounted display devices, such as organic displays, thin film transistor (TFT) displays, light emitting diode (LED) displays. Additionally, it is contemplated that the display may incorporate a multi-layer device, wherein one layer is generally opaque and a second layer is a generally opaque dot-matrix layer, wherein the opaqueness of the first layer may be manually or automatically adjusted thereby allowing the heads-up display to be utilized in many different ambient light situations. While the present invention has been described as utilizing a single display device, it is contemplated that a second display device may be utilized for stereoscopic vision. The second display device may be a conventional display device such as a cathode ray tube (CRT) device, a liquid crystal display (LCD) device, or a video projection device, wherein the transmitter 84 would be mounted onto the display device.

[0070] It is further contemplated that, a multi-layer liquid crystal display may be utilized in accordance with the present invention, wherein the multiple layers are capable of simulating three-dimensions. By utilizing two display devices a three dimensional workspace may be simulated. Such a system could be utilized to simulate a "real" world experience in the virtual environment and would further provide haptic feedback. As such, the three-dimensional display device would be configured to interact with the software components of the present invention. The present invention would utilize a display device having two LCD screens, wherein a left view model is generated and a right view model is generated by a graphic processing unit (GPU). An example of such a system can be seen in Figure 5, where there is shown an exemplary embodiment of the three dimensional system in accordance with the present invention. As shown in Figure 5, a user's right

and left eyes would focus on the right and left view model generated in the display device, wherein the user's brain can comprehend the information displayed on the display device and decide the distance and depth of the displayed object. Thus, the user would believe that they are seeing a true three dimensional display of the object displayed on the display device.

[0071] Referring now to Figure 6, there is shown an alternative display device in accordance with the present invention. As shown in Figure 6, the display device may be a conventional display device such as a cathode ray tube (CRT) monitor or a liquid crystal display (LCD) monitor, wherein the tracker would be in association with the monitor frame. For example, the transmitter maybe positioned in the upper corner of the monitor frame, wherein the physical location of the transmitter will be utilized to establish an origin for the coordinate system of the present invention as will be described in greater detail. Further still, it is contemplated that the transmitter may be placed in other locations on the frame of the display device or alternatively in a location near the display device. In addition to conventional display devices as described above, other types of display devices may be utilized. For example, a video projector may be utilized to project an image on a surface, wherein the transmitter will be placed near one corner of the projected image. The projected image may be directed onto a screen, wall or similar vertical surface, or alternatively, the projector may be mounted such that the image is projected onto a horizontal surface such as a conference table. Further still, the display device may be a combination of devices, for example, a video camera and a CRT or LCD or projector, wherein the present system and methods may be utilized for video conferencing.

[0072] In another embodiment, it is contemplated that the display device may be embodied in the form of a physical display device such as a white board, chalkboard or a similar device, wherein the transmitter would be mounted to one corner of the board.

[0073] Still further, it is contemplated that any of the display devices described above may be utilized in any combination. For example, a user may utilize a head mounted display device and a projector simultaneously in accordance with the methods described in the present application.

[0074] As shown in Figures 1-6 the present invention further includes at least one sensor device 86 disposed on the user. The sensor device 86 is preferably disposed on the user's hand, and most preferable disposed on the user's fingertip. It is contemplated that at least one sensor 86 may be disposed on each of the user's fingertips. As shown and described in Figures 3 and 4, the sensors are in communication with the SEU 80.

[0075] The sensor(s) 86 are comprised of multiple coils encased in a protective housing, wherein the coils are configured to interact with the electromagnetic field generated by the transmitter 84. Each of the sensors are configured to generate at least one electrical signal, and more preferably between about three and six electrical signals in response to interaction with the signal generated by the tracking device. The electrical signal(s) generated by the sensor 86 are passed through the cable connection to the SEU 82, wherein the signals are amplified and converted into a digital signal. In addition to converting the sensor signals into digital form, the MD-BIOS further assigns a unique sensor id to each sensor. The digital signals are embodied in the form of coordinate information of the sensor, such as, x, y, z, and yaw, pitch and roll information. This coordinate information is then passed from the SEU 82 to the computing system 10.

[0076] Referring now to Figure 7, there is shown an alternative embodiment of the tracker system 80 in accordance with the present invention. Wherein in the alternative embodiment it is contemplated that the sensors 86 may be connected to a transducer 81, wherein the transducer is configured to convert the analog signals to digital signals and wirelessly communicates the digital data to the SEU 82. In one embodiment in accordance with the present invention, the transducer 81 is configured to be hard wired to at least five sensors. In this configuration the transducer would assign a unique sensor identification (ID) to each sensor, wherein this unique sensor ID would be transmitted to the SEU 82 along with the coordinate data of each sensor. Although the transducer has been described as being wirelessly coupled to the SEU 82 it is contemplated that it may communicate with the SEU 82 through a wired communication port. It shall be understood that more than one transducer 81 may be utilized with the system in accordance with the

present invention. For example, sensors may be disposed on each fingertip of a user's hands, wherein at least two transducers 81 will be utilized, one transducer 81 being disposed on each of the user's hands and in association with the sensors disposed on each of the user's fingertips respectively.

[0077] Although the SEU 82 has been described as being an independent component separate from the computing system 10 it is contemplated that the SEU may be integrally formed with the computing system. For example, the SEU may be configured to be a removable communications card in the form of a PCMCIA card, compact flash card, PCI card or other similar removable devices. Alternatively, SEU may be integrated into the system board of the computing system.

[0078] Although specific hardware has been described in conjunction with the present invention, it shall be understood that it is contemplated that variances in the described hardware may be undertaken without departing from the scope of the present invention.

METHODS

[0079] In accordance with the present invention, methods of use of the present invention will be described in detail below, wherein it shall be understood that these components will be described in a general sense and should not be considered limiting in any manner. In accordance with the present invention, various mechanical components are utilized in conjunction with software and electronic components to define the system and methods in accordance with the present invention.

[0080] In accordance with the present invention there are provided software components configured to control the various hardware component of the present invention wherein the software and hardware components together form the system of the present invention. Referring now to Figure 8 there is shown an exemplary functional flow chart illustrating the interaction between the various software components of the present invention. As shown in Figure 8, the software components in accordance with the present invention

comprise a virtual environment manager (VEM) 100 and a multi-dimensional basic input/output system (MD-BIOS) 110, wherein the software components are configured to interact with the hardware components described above. Furthermore, it is contemplated that the software components of the present invention will be embodied in a computer readable media such as a cd-rom, dvd, hard drive, flash memory, programmable read only memory or any other type of computer readable media.

[0081] As shown in Figure 8, the VEM 100 receives coordinate data and a time stamp from MD-BIOS 110, wherein the VEM 100 utilizes the coordinate data to simulate virtual device actions and display the virtual device actions on the display device. Additionally, MD-BIOS 110 and VEM 100 are in communication with an operating system. It shall be understood that the VEM 100 can be tailored for each application purpose. For example, if the system in accordance with the present invention is configured to virtually simulate a computer workstation, then the VEM 100 would be configured as such to generate a virtual workstation. Additionally, if a gaming system is to be replicated then the VEM 100 would be a virtual gaming manager, if a conferencing system is to be replicated then the VEM would be configured to be a Virtual Conferencing Manager. It shall be understood that the above examples should not be considered limiting in any manner, in that they have been provided for exemplary purposes only.

[0082] Referring now to Figure 9, there is shown an expanded embodiment of MD-BIOS 110 in accordance with the present invention. As shown in Figure 9, MD-BIOS 110 receives coordinate data from the SEU, wherein MD-BIOS adds time stamp information to the coordinate information. Referring now to Figure 10, there is shown an exemplary embodiment of the memory structure of MD-BIOS, wherein data received from each sensor is interpreted and placed into appropriate memory location in the memory structure as shown. MD-BIOS is capable of receiving data from a multiple number of sensors, wherein each sensor is assigned a sensor identification tag (id) by the MD-BIOS or transducer depending upon the system's configuration.

[0083] Applications that utilize MD-BIOS not only can read the sensor id's and their properties, but can also check the sequence number to know the

difference between each input to the application. Applications can also interact with MD-BIOS in one of two ways or in a combination of each. For example, it is contemplated that multiple programs running in a memory space of the personal computer may utilize different sets of sensors. For example, in association with the virtual workstation embodiment, a number of sensors associated with the user's fingertips may be utilized to control the virtual keyboard and mouse in a word processing program, while another program may be collecting data from other sensors associated with the present invention. For example, the present invention may be utilized in a laboratory setting, wherein in addition to manually entering data by utilizing the virtual keyboard, a scientist may wish to automatically collect data from an experiment or room conditions. In this embodiment, the scientist would dispose additional sensors to measure to desired properties. For example, one sensor would be utilized to measure room temperature, another for humidity, another to measure ph or another chemical property of an experiment, etc.

[0084] The first method of program interaction is referred to as synchronized interaction. In the synchronized method, if one or more applications are interested in the same set of sensor id's the applications need to register to MD-BIOS to listen to the set of sensor id's which each application has interest and leave a call-back function address with MD-BIOS. Therefore, whenever data is updated, MD-BIOS interrupts the application to acquire the data, then the application resumes processing the data. This provides synchronous operation of data processing and data acquisition. In the asynchronized method, if one or more unequal frequency applications are interested in the same set of sensor id's, MD-BIOS will filter out the application that requires a higher sampling frequency. MD-BIOS will carry out its best resolution, if the requested frequency is outside the resolution of the tracker, then MD-BIOS will either return an error or will return a reduced frequency rate. In this case, some of the lower frequency applications may need to know the data acquisition gap and therefore utilize the sequence number of the sensor id' to determine the frequency.

[0085] Additionally as previously discussed and shown in Figure 5, MD-BIOS may additionally be utilized to create a true three dimensional virtual

environment through the use of at least two display devices, wherein MD-BIOS generates a left and right view which are then displayed on a customized display device as previously described in the hardware section above.

[0086] Further still, it is contemplated that MD-BIOS may be further configured to control the transmitter in combination with the system electronic unit, wherein the two systems could be utilized to adjust the transmission frequency of the transmitter or switch between the various transmitter types. As described herein in accordance with the present invention, the transmitter is configured to emit an electromagnetic signal that the sensors interact with and produce an electrical signal that is converted into the coordinated received by MD-BIOS. MD-BIOS compares the coordinate information against the previously received coordinate information for each sensor, if the deviation of each sensor is greater than a predetermined amount, for example, sensor movement of a quarter of an inch in one computing cycle at 120Hz would be considered to be excessive. Therefore, MD-BIOS would automatically direct the transmitter to energize the alternative transmitting devices, wherein MD-BIOS would then sample the coordinate generated by all transmitting devices, if one set of coordinate information is outside the parameters as described above then that coordinate information is discarded and the other two sets of coordinate information are compared. If the two remaining coordinate information sets are similar, MD-BIOS chooses one of the transmitting systems and turns the remaining systems off. Therefore, MD-BIOS will automatically switch between the individual transmitting devices if interference is detected. Typically, MD-BIOS will automatically switch without the user's knowledge, though it is contemplated that the user may specify a desired system and adjust the default values to their preferences.

[0087] In accordance with the present invention the Virtual Environment Manager is utilized to generate a virtual workstation environment. The virtual workstation includes a virtual keyboard at least one virtual input device. As described above MD-BIOS receives coordinate data from the sensors adds a time stamp to the coordinate information and stores the coordinate data in a memory structure as shown in Figure 10. The virtual environment manager includes a plurality of action thresholds to determine if sensor movement is to

be interpreted to be an intended user input or is sensor movement can be attributed to inherent user movement such as natural heartbeat or muscle twitching. Initially, these threshold values are set at default levels, though these default levels may be adjusted by the user to suit the user's own preferences.

[0088] Referring now to Figure 11 there is shown threshold values that the VEM utilizes for determining if sensor movement correlates to intended user input. After receiving coordinate data from MD-BIOS, the coordinate data is utilized to determine whether the sensor movement is to be returned as a key press or other intended input or if the sensor movement is due to natural movement. Initially, VEM generates a virtual keyboard having a known origin, wherein the coordinates generated for each of the sensors are compared to the origin coordinates to determine where the user's hands are in relation to the keys of the virtual keyboard. A virtual input device, such as a mouse is also generated wherein a set of origin coordinates are also established for the virtual input device, thereby allowing VEM to determine sensor location in relation to the virtual keyboard and virtual input device.

[0089] As shown in Figure 11, the key press threshold is a vector property wherein a value of less than negative one millimeter of a sensor's coordinates will be interpreted as a key press, wherein VEM will compare the sensor's coordinates to the origin coordinates of the virtual keyboard or mouse to determine the proper key press. The key press will then be transmitted to the appropriate program, such as a word processing program, text-editing program, graphics program, etc... A key release will be interpreted as a vector having a value of greater than 1 millimeter and having duration greater than one second. A key hold will be determined by MD-BIOS as a vector having a value equal to one millimeter.

[0090] Movement of the virtual input device is determined by vector movement of the sensors, if the coordinate values of the sensors are moved less than one millimeter then VEM will not consider this to be a mouse movement, if the coordinate movement is greater than one millimeter this will be interpreted as a mouse move. To determine if the user intends to depress

a button on the mouse, VEM utilizes the threshold values which have been pre-established for key presses on the virtual keyboard.

[0091] In accordance with the present invention a series of functional flow diagrams will be described herein, wherein the functional flow diagrams are utilized to illustrate the interaction between the various components of the present invention.

METHODS

[0092] In accordance with the present invention there is provided methods for a virtual computing environment. Wherein a virtual environment manager will be embodied in the form of a virtual workstation manager. That is the present invention will be utilized to replicate a personal computing system and the physical input devices in a virtual environment. As will be described in detail below, the virtual workstation manager will generate virtual input devices such as a keyboard, a mouse or other input devices.

[0093] Referring now to Figure 12, there is shown an exemplary embodiment of a method in accordance with the present invention, wherein the VEM and MD-BIOS are embodied in a computer readable medium. The method according to the present invention comprises the steps of: initializing a computer system, including initializing the SEU, loading an operating system into a memory space, loading VEM and MD-BIOS into a memory space. As soon as MD-BIOS is loaded into a memory space, MD-BIOS begins to receive coordinate information from the SEU; VEM then begins to scan for sensor movement to determine if any sensor movement passes the threshold values. A display device is initialized, wherein VEM (such as VWM) then displays virtual hands, virtual keyboard and at least one virtual input device on the display device. MD-BIOS each of these processes will be described in greater detail with reference to detailed functional flow diagrams.

[0094] The methods according to the present invention may utilize hardware devices such as those described above or hardware devices similar to those shown and described above, wherein the present invention utilizes software

or firmware to control the hardware in a manner to replicate a virtual environment. In accordance with the present invention comprises at least one software program or firmware code previously described herein wherein the software includes the VEM and MD-BIOS programs

[0095] Referring now to Figure 12 there is shown a functional flow diagram illustrating exemplary steps of the method in accordance with the present invention. At Box 190 a computing system is powered on, this includes powering on the SEU additionally if the SEU is embodied as an individual component separate from the computer system. As Box 200 an operating system is loaded into a memory space. At Box 210 MD-BIOS and the Virtual Environment Manager are loaded into a memory space within the computer system. After loading MD-BIOS and the virtual workstation manager into a memory space, MD-BIOS immediately begins receive coordinate information from the SEU at Box 215. As described in detail above the electrical signals generated by the sensors are converted to coordinate information and a time stamp is added by MD-BIOS and the data is stored in a memory location. VEM then compares the coordinates of each sensor to determine if motion of the sensor(s) has occurred and whether the sensor motion is intended to be a key press on the virtual keyboard or virtual mouse. The transmission and scanning rate of the tracker is controlled by MD-BIOS. Wherein the scanning and transmitting frequency of the tracker is controlled in response to the physical location of the sensor(s) in relation to the tracker and the origin coordinates of the virtual devices. For example, as the sensors are moved closer to the virtual devices the scanning rate of the tracker will be increased, thereby increasing the accuracy and resolution of the system. When the sensors move away from the virtual devices, the scanning rate is reduced, thereby lowering the power consumption of the devices. In addition to controlling the scanning rate, VEM also may be configured to display a visual indicator of the sensor(s) position on the display device as well as provide auditory feedback to the user. For example, as the sensor(s) are moved to a location above the virtual keyboard, the sensor may change colors to indicate how close the sensor is to the keyboard, when the sensor moves toward the keyboard, VEM changes the color of the sensor to indicate a key press and provides an auditory response to the user to denote a key press.

[0096] In an alternative embodiment the virtual keyboard may be configured to respond to absolute movement of each of the user's fingers (sensors). In this embodiment, the threshold values are set to zero or near zero, wherein any movement of the user's finger will correlate to a typing motion or mouse motion depending upon where the user's fingers are located in relation to the virtual devices.

[0097] At Box 230 the system prompts the user to enter the user's login and password. At Diamond 235 it is determined if the user already has a password and login then Box 237, where the user's saved settings are loaded into a memory space. A user's settings may control what is displayed on the virtual display device such as input devices (keyboard, mouse, tablet), the location of these input devices in the virtual setting and any other user definable preferences such as visual or audio feedback, tactile feedback and sensitivity of sensor movement, or other preferences. For example, user A may have saved settings from a previous use, wherein once logged into the system, VEM (such as VWM) displays a virtual keyboard, a virtual monitor and a virtual mouse, wherein the virtual workstation manager controls the origin coordinates of where each of these devices will be displayed in the virtual environment. If it is determined in Diamond 235 that a new user is logging in then at Box 239 default values for the virtual devices displayed on the display device are loaded into memory. At diamond 242, the system prompts the user whether or not they want to customize the default values. If the user chooses to customize the default values then Box 243. At Box 243 the user's customized settings are saved under their login profile and then to Box 240. If the user does not choose to customize the default settings then Box 240.

[0098] At Box 240 the display device is initialized and at Box 250 the virtual devices are displayed in the virtual environment at the location dictated by either the user's settings or the loaded default values.

[0099] If the user is a previous user, the virtual environment manager will be called wherein the user's preferred settings will be retrieved from a memory location and loaded into a memory space. If the user is new to the system,

the Virtual Environment Manager will be continue to use system default values into memory. These default values may be changed by the user and saved under the user's personal profile before exiting the system, wherein these settings will be loaded when the user utilizes the system in the future.

[00100] Examples of user definable settings are the type and style of keyboard that will be displayed in the virtual environment. For example, the user may prefer to utilize a standard size keyboard having a standard QWERTY layout, or the user may prefer to utilize an ergonomic keyboard. Additional settings would be the physical location of the keyboard in the virtual environment. Such that when the system is initialized the keyboard will be shown in the virtual environment wherein the coordinates of the keyboard are known. In addition to displaying a keyboard as a user setting, additional settings may control the display of other virtual input devices such as a mouse, a virtual monitor or similar devices. Each of the virtual devices displayed within the virtual environment will have origin coordinates known to the virtual environment manager. The user in the virtual environment may control the style, size and location on the virtual input devices. For example, the keyboard may include handles, wherein the user can grab the handles in the virtual environment and move, stretch, pull-apart the keyboard. The other virtual input devices may also include handles to allow the devices to be re-positioned re-sized or stylized within the virtual environment. When the computer system is powered down, the virtual environment manager can saves the user's settings, wherein the virtual environment may be loaded each time as left by the user in each previous use

[00101] Once the user has logged into the computer system, the operating system and virtual environment manager and MD-BIOS finishes loading into memory with the user's settings. After loading the operating system and MD-BIOS into memory, the display device is initialize, Box 240, wherein a graphical user interface (GUI) is displayed on the display device Box 250. For example, if the operating system is based on Microsoft Windows® then the standard GUI interface will be displayed in the display device. In addition to displaying the operating system's GUI, virtual input devices will also be display on the display device. As described above, the placement, size, shape and orientation of the input devices as displayed

within the virtual environment is dictated by either the users saved preferences or in the case of a new user the default settings of the Virtual Environment Manager. In addition to displaying virtual input devices on the display device, a virtual set of hands may also be displayed if the user is wearing sensors on each of their fingertips.

[00102] Referring now to Box 260, the transmission rate of the signal is controlled by MD-BIOS and the virtual workstation manager in conjunction with the coordinate location of the sensors in relation to the tracker. The transmission rate of the tracker may be controlled according to sensor position. For example, if it is determined that the sensor is disposed near the known location of an input device, then the tracker's scan rate will be increased to increase accuracy of the system, if the sensor is disposed at a given distance from any virtual input device than the transmission rate of the tracker will be reduced, thereby saving power and reducing processing cycles. Further still, as described above, if coordinates received from the SEU are outside the operating parameters of the system, MD-BIOS will direct the transmitter to energize the alternative transmission sources, wherein the coordinates generated from these alternative transmission sources will be compared and the strongest or more accurate coordinate information will be utilized. Wherein MD-BIOS will direct the transmitter to turn off the alternative transmitting devices. In a preferred embodiment this process will occur automatically without any user interaction.

[00103] Referring now to Box 270, each of the sensors are constantly sampled by the SEU and coordinate data is sent to MD-BIOS where a timestamp is added and the information is placed into a memory location.

[00104] At Diamond 280, the virtual environment manager and determines if the velocity component(s) and the vector component(s) of the detected sensor motion pass threshold values. Threshold values are utilized to filter out undesired input as well as increase system accuracy. For example there are natural vibrations associated with humans such as heartbeat, slight hand motion or other natural vibrations. If it is determined that the vector components are greater than the threshold values, then it is determined if the coordinates are in the vicinity of the known coordinates of

the virtual input devices generated by the virtual environment manager. For example, if the coordinates received correlate to a keyboard position for a letter, the velocity component and the previous coordinates are compared to determine the intentions of the user. By comparing the previous coordinates and the present coordinates in addition to the velocity component it can be determine if the motion is intended to replicate a keystroke, key release, key hold or key repeating. If the coordinates correspond to the location of the mouse, then the vector and velocity components will be utilized to determine if the user intended a mouse move, a mouse button depress/release, or a single or double click.

[00105] The movement of the sensors will be displayed on the display device in the form of a virtual set of hands or in the case of mouse motion, movement of a pointer within the virtual environment. In addition to displaying motion within the virtual environment, it may also be desirable to provide feedback in the form of audio, tactile, or visual feedback of interaction between the user and the virtual input devices. For example, if a key is determined to be depressed on a keyboard, then the virtual keyboard will be displayed wherein the chosen key is illustrated as being depressed. In addition to the visual feedback, audio or tactile feedback maybe provided in the form of "clicking" sounds intended to replicate the physical sound of a standard keyboard.

[00106] At Box 300 and 305 the coordinate information generated from sensor motion is compared to the known coordinate information of the virtual input devices. For example, if a virtual keyboard is displayed according to the user's defined settings, coordinates of the keyboard are a known value that are stored within the shared memory manipulated through MD-BIOS API calls. Thus, when coordinates are calculated from sensor motion, the coordinates transmitted from the memory location of MD-BIOS are compared to the known coordinates of the keyboard. If the coordinates correspond to or are within a pre-defined range of an individual key disposed on the keyboard then the virtual environment manager will determine the user's intention as indicated in Box 330. The virtual environment manager determines the user's intention by comparing the velocity component generated by sensor movement and comparing the velocity component to a known value. For

example, if the vector component is toward the plane of the keyboard, then the virtual workstation manager will interpret this to indicate a key press on the virtual keyboard. If the vector component is away from the plane of the keyboard it may also indicate that a key release was performed and the user's finger is moving away from the key. If the velocity component is zero or nearly zero this may be interpreted to indicate a key hold, such as a user holding down a shift key or the like. A vector of zero may also indicate a key repeating such as when a typed word includes two or more of the same characters. After the user's intention is determined then at Box 305, the intended information is sent to the operating system for entry into the event queue or windows manager. In accordance with the present invention, the key presses may be determined utilizing pure vector and velocity without consideration of the z-axis component. This would allow a user to utilize the present system while resting their hands on a surface, such as a tabletop or upon their person or the like.

[00107] At Box 300, the user's intended motion may be displayed on the virtual display device in the form of a virtual key-press on the virtual keyboard, motion of a virtual hand or pair of virtual hands, or an auditory or tactile response may be generated in response to the sensor's motion.

[00108] At Box, the system returns to Box 270, wherein the system returns to scanning for sensor motion and the process is repeated until the system is powered off.

[00109] It shall be understood that although the sensor motion component has been described herein in reference to a key press on a keyboard it shall be understood that this should not be considered limiting in any manner. In that the coordinates may correspond to any type of virtual input device, wherein each virtual input device has parameters which are utilized by the virtual environment manager to interpret the sensor motion. For example, if the coordinates received correlate to coordinated for a mouse, it will be determined if the coordinates define movement of the mouse, which will be displayed within the virtual environment. A mouse button press, mouse button release, a single button press or a double button press.

[00110] It is further contemplated that the virtual environment manager may be capable of distinguishing between different sets of sensors by each sensor(s) or transducer(s) unique ID. For example, if two users both utilizing a system in accordance with the present invention are near one another each tracker will only track those sensors to which the system is initialized. Thus, multiple systems can be utilized within close proximity to one another.

[00111] As shown in Figure 12, the functional flow diagram illustrates a graphic based system, wherein the virtual reality system in accordance with the present invention is configured to display three-dimensional virtual input devices in a virtual environment. It is further contemplated that the present invention may be utilized in a text-based system. In a text based system the functional flow diagram as shown in Figure 12 would not include Box 200 wherein the operating system is loaded into a memory space. In the text-based system the virtual keyboard generated by the virtual environment manager would be displayed one dimensionally and the virtual input device in a preferred embodiment would be a touch pad or a similar tracking device.

[00112] It is further contemplated that a portion of the software components of the present invention may be embodied in the form of a BIOS chip, wherein the BIOS chip would be installed on the computer system's mother board, such that when the computer system is powered on the software in accordance with the present invention would be loaded into a memory space from the BIOS.

[00113] Referring now to Figures 13 and 14 there are shown exemplary embodiments of various virtual keyboards as displayed in the virtual environment. As shown in Figure 13, the virtual keyboard 300 may be disposed over the top of the virtual mouse 310 thereby allowing a user to immediately toggle between the keyboard and the mouse without having to physically move the sensors a great amount. This type of setup reduces motion associated with switching back and forth between the keyboard and the mouse, thereby potentially reducing repetitive stress injuries. Further still by providing such a layout, users of programs that require a user to switch back and forth between a pointing device and text input may be able to

increase their productivity because less time is spent switching between the two devices. Referring now to Figure 13, there is shown the virtual keyboard 300 and virtual mouse 310, wherein the virtual mouse is disposed over the virtual keyboard. As shown in Figures 13 and 14 the virtual mouse can be transposed between the two positions shown either through specific hand motions wherein the sensors and VEM generate a specific signal to transpose the mouse from one position to another. Alternatively, the mouse may be transposed utilizing a voice command, a hot key associated with the virtual keyboard or a hot spot located on within the virtual display. Additionally, although a conventional computer mouse is shown being displayed in the virtual environment, it is contemplated that any type of input device may be displayed, for example the input device may be a touch pad, trackball, tablet and stylus or similar input devices.

[00114] Referring now to Figures 15 and 16 there is shown yet another application of the system in accordance with the present invention, wherein the system of the present invention is configured as a virtual car control system (VCCS) 400. In the present embodiment, the VCCS comprises software and hardware components, wherein the software and hardware components interact to provide a virtual system that enables a user to control various systems within an automotive environment without physically removing their hands from the steering wheel and shifting their eyesight from the road.

[00115] The VCCS system 400 includes hardware and software elements to replicate and control mechanical and electrical controls within an automotive environment. The VCCS includes a computer unit 410, a tracker system 450 including a system electronic unit 420, at least one sensor 425 and at least one transmitter 430, a control button 460 and a heads up display device 470 or alternatively a see through HMD. The VCCS further includes software components 480 stored on a computer readable medium disposed within the computer unit 410. The software components include an operating system 482, a virtual environment manager program 484 and a multi-dimensional basic input/output subsystem (MD-BIOS) 486 program.

[00116] Referring now to Figure 16 there is shown an exemplary embodiment of the VCCS as seen from a user's perspective in accordance with the present invention. As shown in Figure 16, an image showing three-dimensional buttons 500 would be projected onto the windshield 505 by a heads up display device 470, when the buttons are displayed on the windshield coordinate information is associated with each of the buttons. The coordinate information of each button locates each button in space in a plane spaced apart from the steering wheel, this can be seen by the three-dimensional buttons disposed on box 510 which are shown for exemplary purposes only and will not be actually seen by the user. By placing the origin coordinates for each button in a plane aligned with the physical steering wheel of the vehicle, the user may interact with the buttons without removing their hand's from the steering wheel. In addition to the three-dimensional buttons displayed on the windshield, the VCCS may further include at least one physical button. In a preferred embodiment the physical button(s) would be disposed on the steering wheel or steering column. The physical buttons may be utilized to turn the heads up display on and off, menu return, enter, clear, dial, send or any similar command which may be utilized to control any aspect of the VCCS system.

[00117] In use, at least one sensor would be disposed on a user's person, in a preferred embodiment at least one sensor would be disposed on each of the user's thumbs, but it is contemplated that additional sensors may be disposed on the user's additional fingers. The sensor(s) interact with a signal generated from a transmitter, wherein the sensors produce a position signal due to interaction with the transmitted signal. The position signal is converted into coordinate information by the SEU after being transmitted to the SEU. The coordinate information is transmitted to the MD-BIOS software where time stamp data is added and the coordinate information is stored in a memory location. It is further contemplated that a sensor identification tag may also be associated with the sensor, added by the SEU or added by MD-BIOS to the coordinate data. The coordinate data is then utilized by the VEM to determine if motion of a sensor passes threshold values, and if so, what is the user's intent, the coordinate data is then compared to the origin coordinate information for each of the three-dimensional buttons virtually located in a plane adjacent to the steering wheel. A virtual hand may also be

displayed on the windshield to illustrate the motion of the sensor or a cursor or other visual marker may be displayed on the windshield so that the user may visually correlate their hand location on the steering wheel with the virtual three-dimensional buttons displayed on the windshield.

[00118] As described above the VCCS system in accordance with the present invention provides a virtual interface allowing a user to control various components of an automobile. Each of the buttons would be displayed on the windshield as having three-dimensional characteristics. Wherein multiple layers of buttons may be utilized to control various systems. For example, as one button is pressed, additional buttons may be displayed on the windshield, wherein the additional buttons are displayed as being tiled over the previous layer of buttons. This may be better understood as shown in Figures 17-19 wherein there is shown an exemplary embodiment of the VCCS system in use in accordance with the present invention.

[00119] Referring now to Figure 17 there is shown a series of three-dimensional buttons as they would be displayed by the heads-up display device and projected onto an automobile's windshield. As previously described, the display device or the VCCS system may be controlled by a physical button wherein, after the button has been depressed the buttons would be displayed on the windshield. The buttons displayed would have origin coordinates that would place the buttons in plane space adjacent to the user's left hand on the steering wheel wherein the first level of buttons displayed would be high-level system buttons. For example, one button will be displayed to access the climate control system, another for the GPS system, and another for an entertainment system and so on. It shall be understood that the list above should be considered exemplary and should not be considered limiting in any manner. If the user desires to access the entertainment system, they would move their thumb to a physical location which would correlate to the virtual entertainment system button, wherein motion of their thumb over the virtual entertainment button would be deemed to be a button press by the software components of the present invention. As a result, a second set of virtual buttons would be displayed by the heads-up display device and projected onto the windshield as shown in Figure 18. The additional buttons displayed would have origin coordinates that would place

the buttons in plane space adjacent to the user's right hand on the steering wheel. As shown, the additional buttons would provide the user with audio/video components as installed, such as AM/FM radio, cassette, compact disc, DVD audio and the like. As shown in Figure 19, the user has selected the CD button, wherein the visual display of the CD button is changed, for example the button is made larger thereby appearing to be in a different plane than the other buttons and the color of the button may change to indicate that the button has been selected. Additionally, it is contemplated that an audible feedback may also be associated with button selection in addition to the visual feedback described above.

[00120] As shown in Figure 19, after selecting the CD button, additional buttons will be displayed adjacent to the selected CD button wherein the additional buttons include controls associated with the CD player. For example, fast forward, skip, rewind, disc selection, mute, volume and menu return.

[00121] Referring now to Figure 20 there is shown exemplary embodiments of additional buttons that may be displayed in accordance with the VCCS system of the present invention. As shown in Figure 20, additional buttons may be displayed to control a navigation system such as a GPS system, Climate control system, communication system such as a cellular phone, as well as automotive control systems such as traction control, system information and the like. As shown in Figure 20, each of the top level buttons have been selected thereby causing the second menu to be displayed on the screen. It shall be understood that the menus shown in Figures 16-20 should be considered exemplary and not limiting in any manner in that the menus may be altered without deviating from the scope of the invention.

[00122] Although the present application has been described in detail with reference to an entertainment system this shall not be considered limiting in any manner. Further still, it is contemplated that the VCCS system may be utilized in combination with mechanical switches or physical control means. For example, the entertainment system may be controlled with the UCC system by the driver and also may be controlled by the driver or a passenger with conventional means installed in the automobile. As described previously,

the heads-up display may be controlled by a mechanical switch, a virtual switch or the display may be time controlled, wherein once activated, if no input is received from the user, the display will turn off, wherein the user can then re-activate the system. It is further contemplated that the system may have additional restrictive controls such as a maximum speed control, wherein the system may not be accessed if the vehicle is traveling beyond a pre-set speed, or if the steering wheel has been rotated past a pre-set degree. Additionally, the VCCS system may utilize voice command software in addition to those hardware and software components described above.

[00123] Although the coordinate information of the present invention has been described herein as being restricted to the x, y, and z-axis, the sensors are further capable of generating yaw, pitch and roll coordinate information in combination with the hardware and software components of the present invention. The additional coordinate information may be utilized by applications not mentioned specifically herein. For example, if the virtual environment manager of the present invention was tailored to represent a virtual flight training simulator, the yaw, pitch and roll coordinates would be utilized to simulate movement of a virtual plane.

[00124] Although the present invention has been described with reference to a virtual workstation such as a personal computer or laptop computer it is contemplated that the system and methods in accordance with the present invention maybe utilized to replace other types of physical systems. Such as Virtual Game station or VR conference. For example, the present invention may be utilized to replace a gaming system such as an X-Box® or a Playstation®. It is further contemplated that the present invention may be utilized in combination with others, wherein the multiple systems may be utilized for communication between each of the users. Systems such as this may be utilized by military forces for covert communications, pilots, motorsport race teams and other similar careers that may require communication amongst more than one person. Another contemplated use for the present invention is warehouse management and inventory control, wherein the user may roam freely around the warehouse entering inventory, fulfilling orders, or maintaining quality control. Although the present invention has been described with regards to specific examples these examples should

not be considered limiting in any manner in that the methods of the present invention may be applied to a wide variety of technologies, many of which were not disclosed here.

[00125] The instant invention is shown and described herein in what is considered to be the most practical, and preferred embodiments. It is recognized, however, that departures may be made there from, which are within the scope of the invention, and that obvious modifications will occur to one skilled in the art upon reading this disclosure.

Claims

What is claimed is:

1. A method for controlling a microprocessor based system in a virtual environment, said method comprising:
 - loading a computer program into a memory space;
 - transmitting at least one signal from at least one transmitter;
 - displaying virtual input devices on a display device, wherein said virtual input devices initially have pre-determined coordinates;
 - receiving data generated from movement of at least one sensor;
 - calculating coordinates of said sensor movement;
 - comparing calculated coordinates to the pre-determined coordinates of each virtual input device;
 - calculating desired input from coordinates generated by said sensor movement; and
 - displaying input on said display device and transmitting said input to said operating system.
2. The method according to Claim 1, wherein said display device is a head mounted display device.
3. The method according to Claim 2, wherein coordinates calculated from said sensor are x,y and z coordinates.
4. The method according to Claim 3, wherein the virtual input devices displayed on said display device are a keyboard and a pointing device.
5. The method according to Claim 1 wherein said transmitter transmits and electromagnetic signal.
6. The method according to Claim 5, wherein said transmitter transmits at least two different signals, one signal being electromagnetic, the second being chosen from the group consisting of: electromagnetic, optical, acoustical, and inertial.
7. The method according to Claim 4 further including the steps of changing the location of said virtual input devices by grabbing the virtual input devices in the virtual environment and dragging the virtual devices to a new location.

8. The method according to Claim 4, wherein said sensor movement is translated to define key presses on said virtual keyboard or movement of said virtual pointing device.

9. The method according to Claim 4, wherein the physical layout of said virtual keyboard may be manipulated by a user through movement of said sensors.

10. A system for virtually controlling a microprocessor based system, said system comprising:

a microprocessor based computer system having an operating system configured to be run thereon;

a display device,

at least one sensor;

at least one transmitter;

a system electronic unit in association with said sensor and said transmitter, said system electronic unit being configured to track movement of said sensor and determine coordinates of said sensor and time components of sensor movement; and

a software component, wherein said software is stored in a computer readable medium, wherein said software is in communication system electronic unit, wherein said software determines vector movement and acceleration of said sensor and displays said sensor movement on said display device.

11. A system for implementing a virtual reality environment, the system comprising:

a display device associated with a user, the display device being responsive to image data for generating and displaying an image simulating a physical computer system, including a physical keyboard, a physical input device, and physical representation of the user's hands, wherein each of the

simulated components appear to the user to be in space independent of actual physical objects;

an output device for transmitting a signal;

an input device for generating data in response to interaction with said signal;

a processor connected to said input and output device and said display device and operating a virtual environment manager program and a multi-dimensional basic input and output program for generating a virtual keyboard, a virtual input device, and virtual hands, the processor being responsive to data generated from said input device, for generating motion image data corresponding to the input device data; and

wherein the display device is responsive to motion image data for generating a second image simulating physical motion of at least one virtual component.

12. A system for implementing a virtual reality (VR) computing environment, the system comprising:

a VR display device including at least one display and worn by a user the one display viewable by the user, with the VR display, responsive to first image data, for generating and displaying a first VR image simulating a physical computer system including a virtual keyboard having a plurality of physical keys, a virtual mouse having at least one physical button, with the first VR image representing the VR keyboard and VR mouse, the VR keyboard and VR mouse having a first appearance corresponding to the first image data;

an input and an output device for generating motion-representative data corresponding to motion of a user's body part; and

a processor connected to the VR display device and operating a virtual environment manager (VEM) and multi-dimensional basic input output

(MD-BIOS) program, wherein the VEM and MD-BIOS provide the first image data to the VR display device, the processor being responsive to the motion-representative data generated from the input device, for generating motion image data corresponding to the motion; and

wherein the VR display device is responsive to the motion image data for generating a second VR image simulating motion corresponding to the motion of the portion of the body of the user.

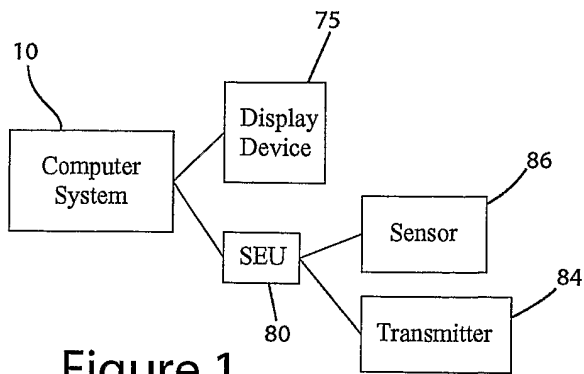

Figure 1

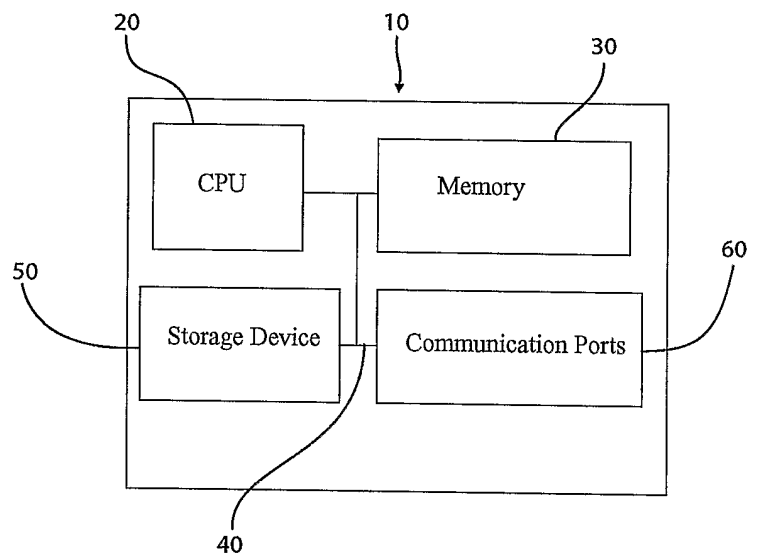

Figure 2

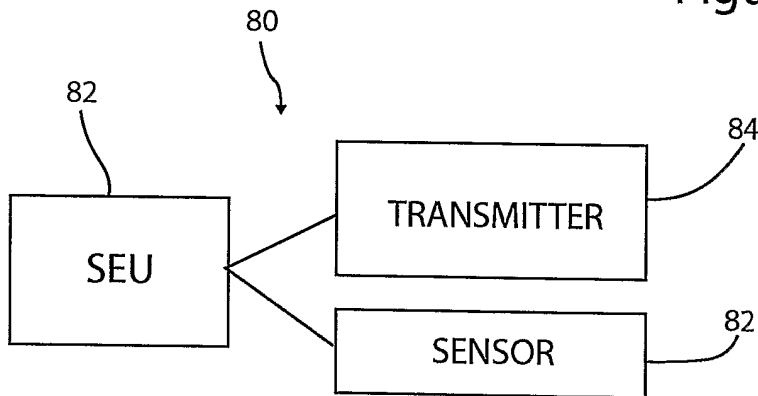

Figure 3

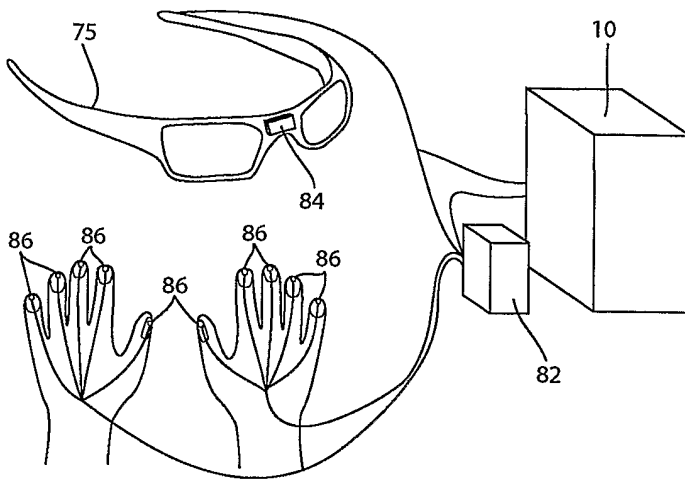

Figure 4

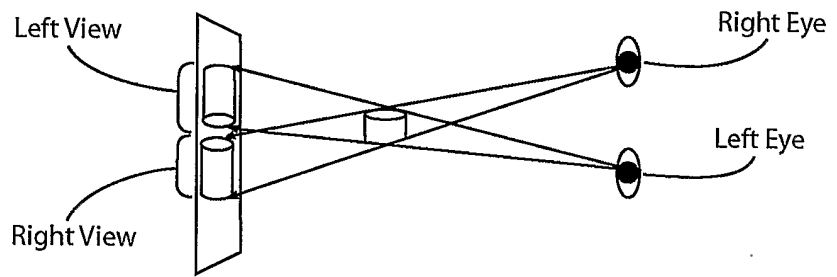

Figure 5

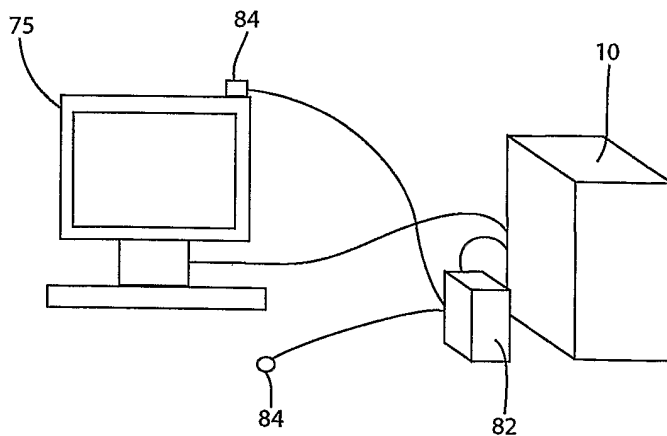

Figure 6

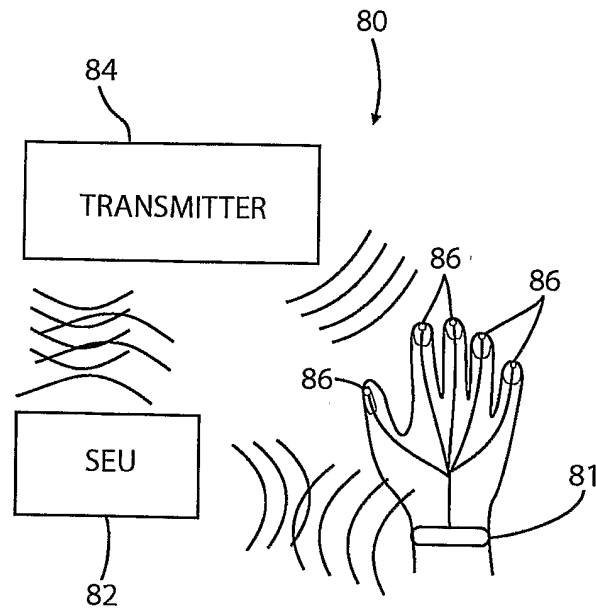

Figure 7

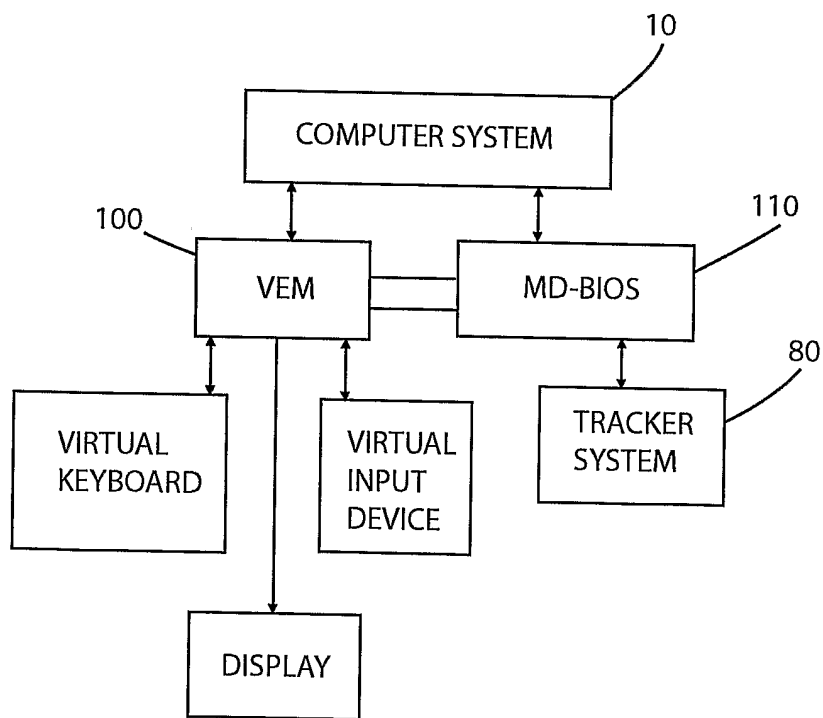

Figure 8

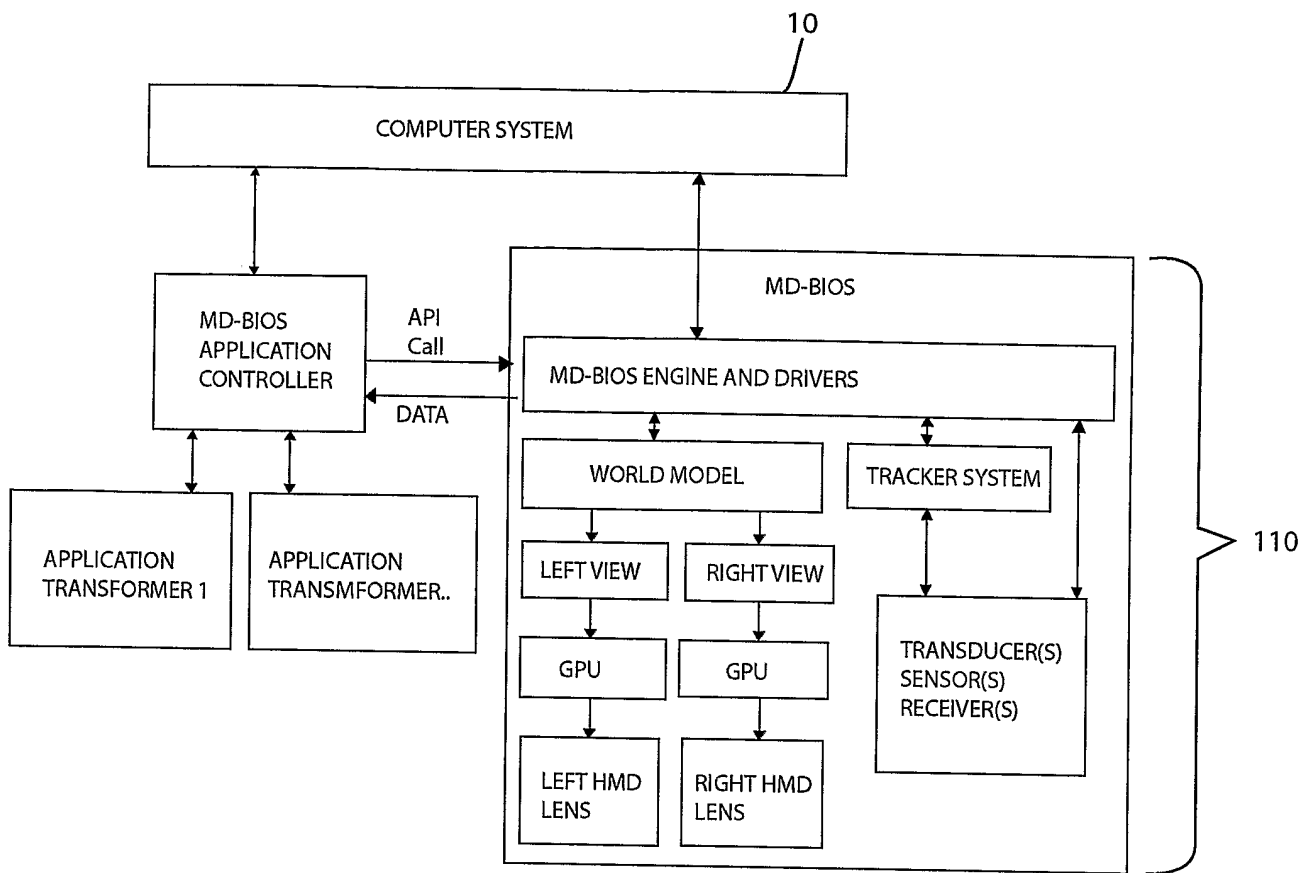

Figure 9

The diagram shows three overlapping tables representing sensor data. The top table is labeled 'Sensor_id 1' and contains the following data:

Property	Value	Unit	Status
Location	(x,y,z)	mm	
Time	19876543	ms	
Sequence #	32145698		
Pressure	356	g/cm2	
Temperature	98.5	C	

The middle table is labeled 'Sensor_id 2' and the bottom table is labeled 'Sensor_id...'. The tables are shown as overlapping, suggesting a sequence of data collection.

Figure 10

Thresholds	Property 1	Values 1	Property 2	Values 2	Comment
Key Press	Vector	< -1 mm	Velocity	1 sec.	If previous coordinate (x,y,z,t) passed (a status in key object) the <i>released coordinate</i> of a key and current vector <-1 mm (e.g. -3), which will make the current coordinate reach the "key hold" coordinate eventually as defined below, when the current (x,y,z,t) reach the "key hold" surface, then the key is considered to be pressed. Less than -1 mm means the sensor is going toward the object surface with distance >1 mm. With large velocity time frame 1 second, means VEM can also allow for a very slow typist.
Key Release	Vector	> 1mm	Velocity	1 sec	If previous coordinate (x,y,z,t) passed (a status in key object) the <i>pressed coordinate</i> of a key and current vector >1 mm/s. When the current (x,y,z,t) eventually reach the " <i>released coordinate</i> " object plane, then the key is considered to be released. Greater than 1mm means the sensor is moving outward the relative perpendicular object plane with distance >1mm in 1 second time frame.
Key Hold	Vector	1mm			If abs(vector)<1mm, (means the calibrated coordinates of the sensor is within 1mm vector difference to the <i>pressed coordinate</i> of the world model of a key), then the key is still on hold. Abs() means moving distance without direction.
Key Repeating	Vector	1mm	Velocity	0.1sec	When a key is on hold as defined above, VEM will generate repeating key 10 characters per second.
Mouse Move	Vector	<1mm	Velocity	1 sec	If abs(vector)<1mm within 1 second, VEM considers as unintentional mouse movement.
Mouse Button Release	Vector	1mm	Velocity	1 sec	Same principle as Key Release. If vector >1mm, then button is released. Which means moving a distance >2mm
Mouse Button Hold	Vector	1mm			Sample principle as Key Hold, If abs (vector)<1mm, the button is being held.
Mouse Button Click	Vector	1mm	Velocity	1 sec	Same principle as Key Press, If vector <-1mm and velocity >1 mm/sec, then the button is considered to be pressed.
Mouse Button Double Click	Vector	2mm	Velocity	0.4 sec	If consequential qualified clicks happen in 0.4 seconds, then to be considered a double click.

Figure 11

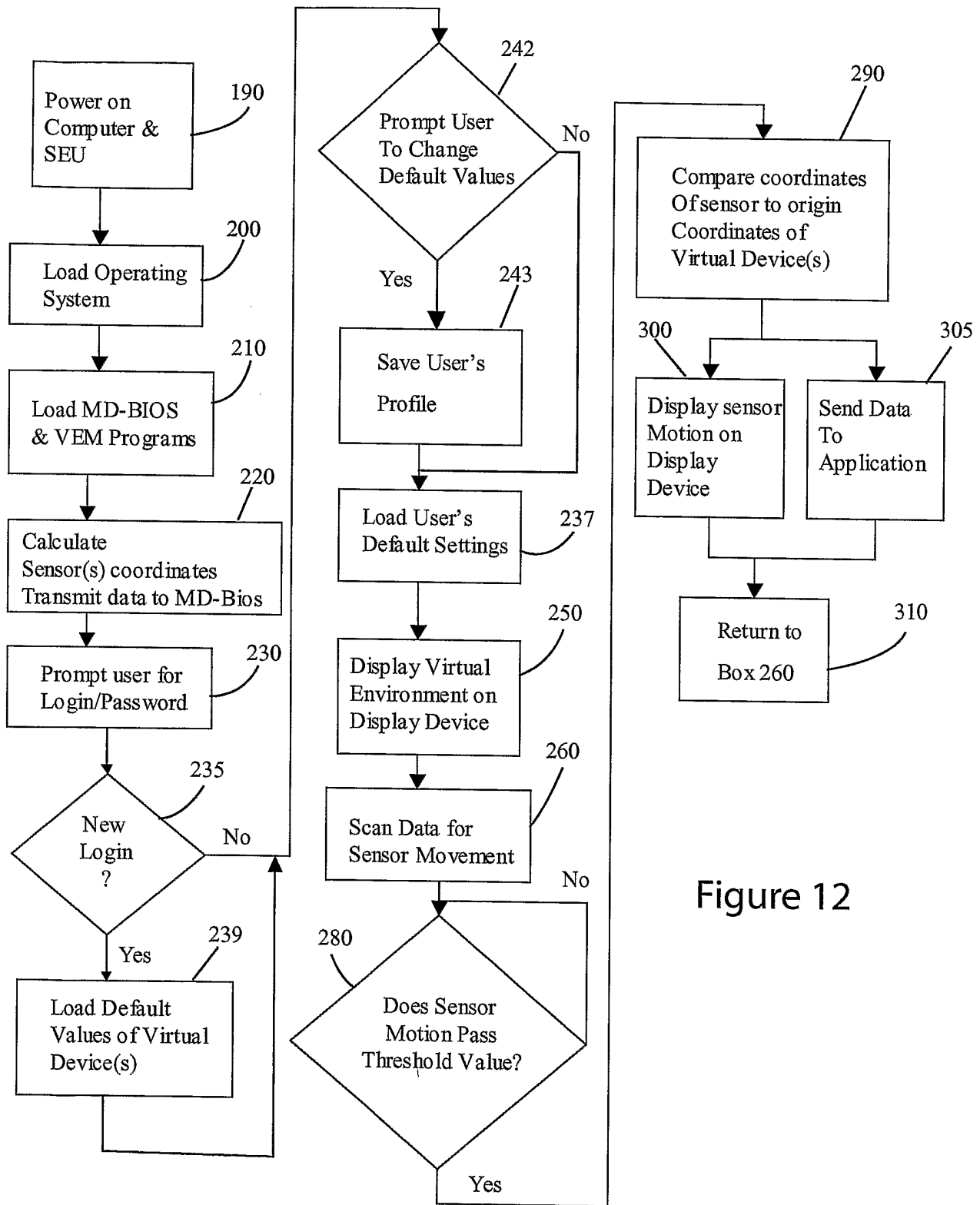

Figure 12

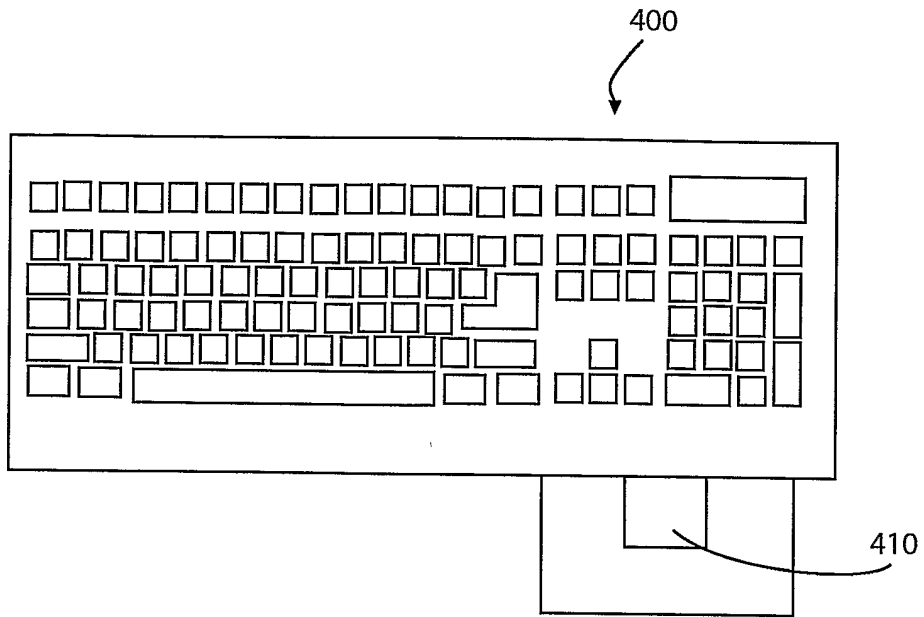

Figure 13

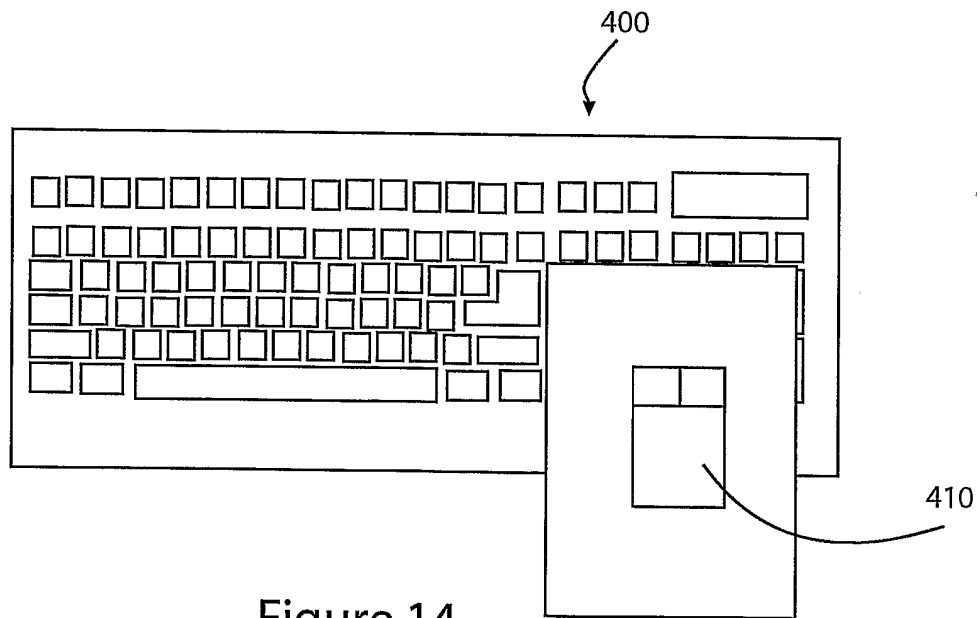

Figure 14

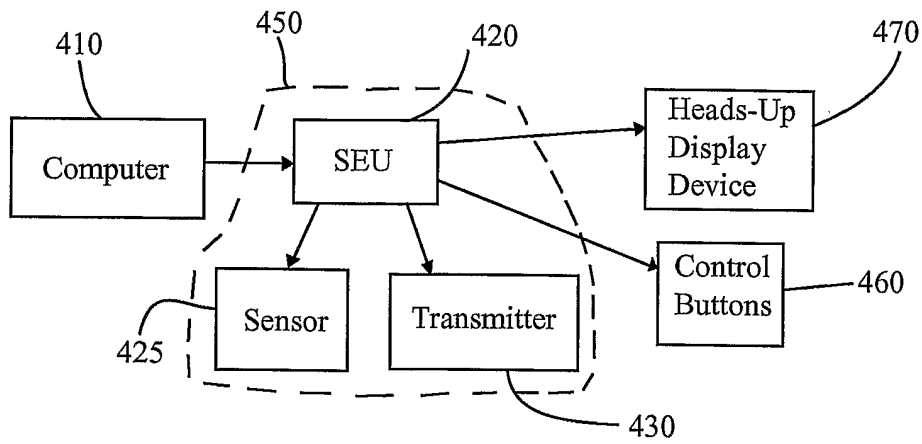

Figure 15

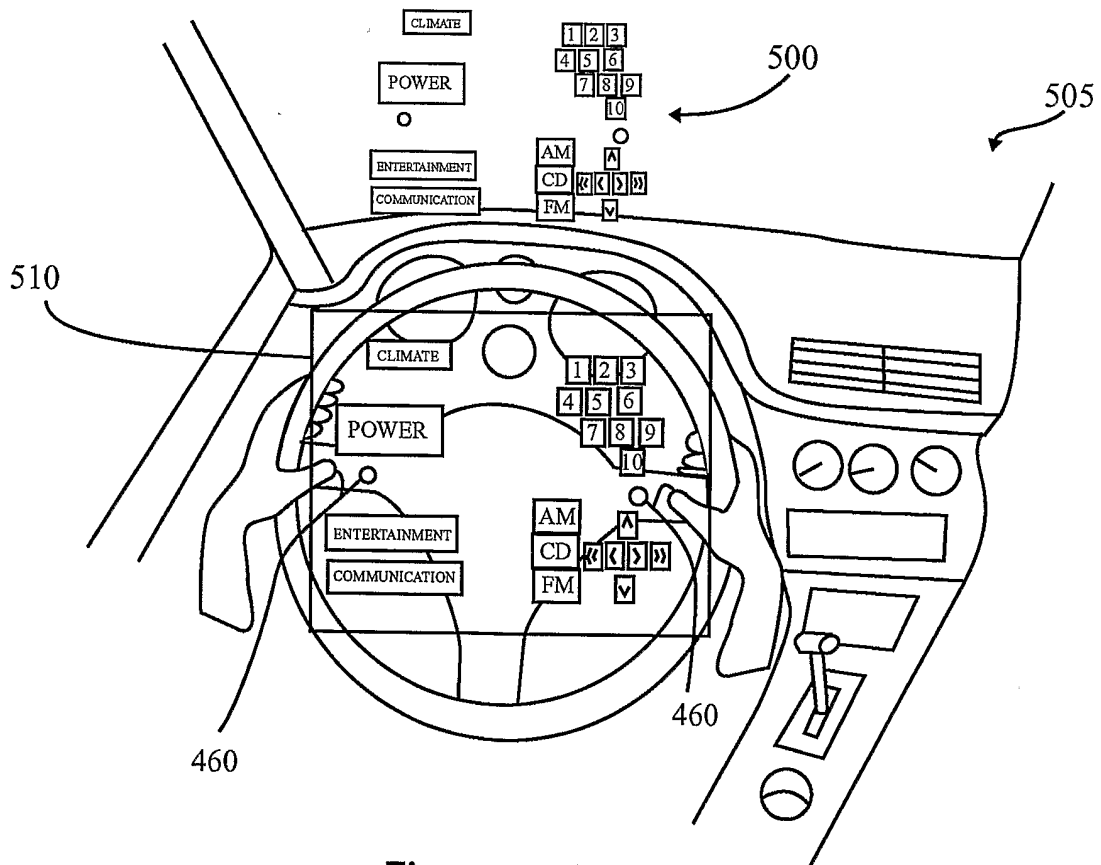

Figure 16

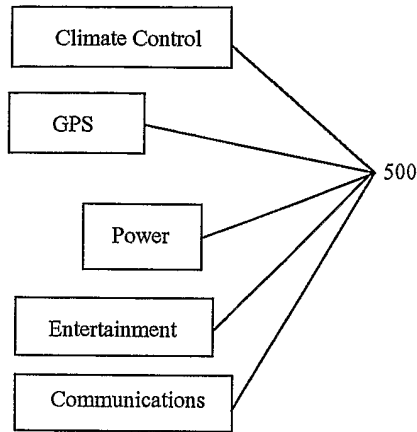

Figure 17

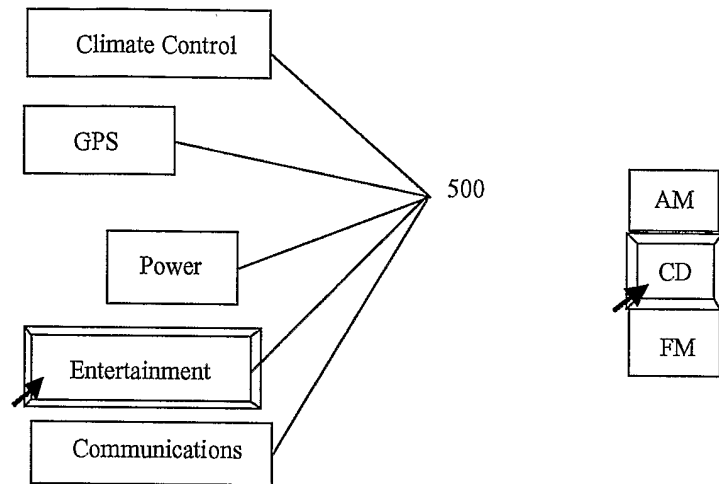

Figure 18

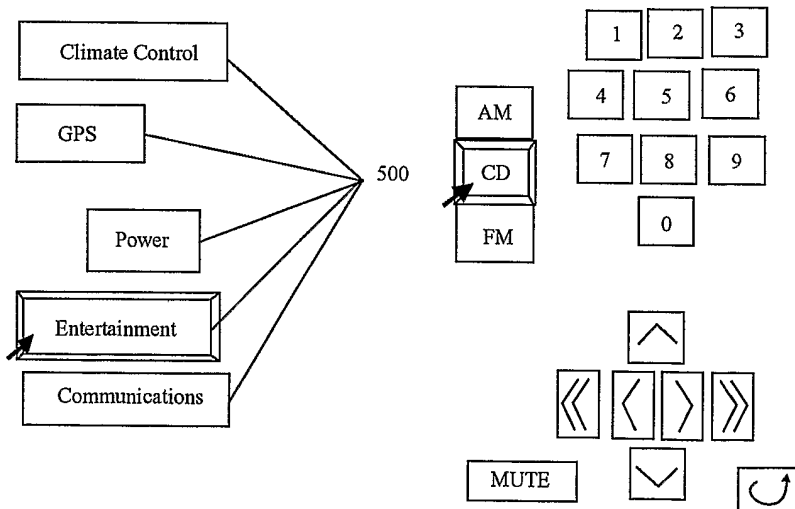

Figure 19

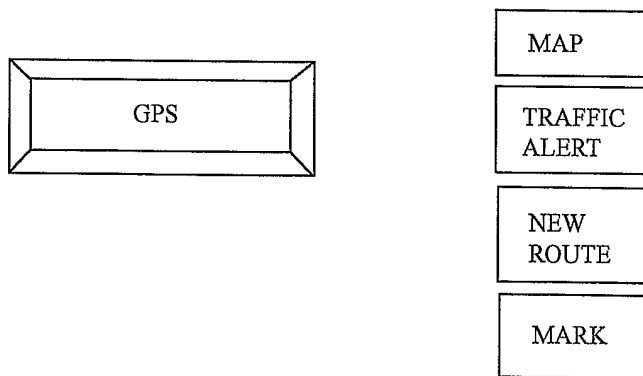
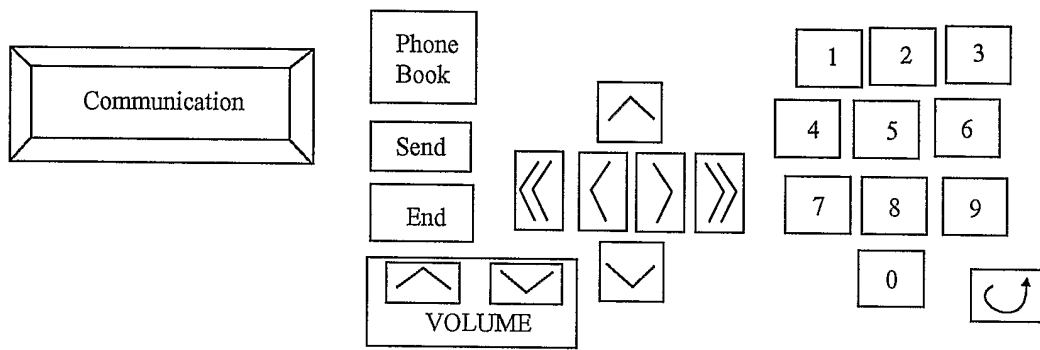
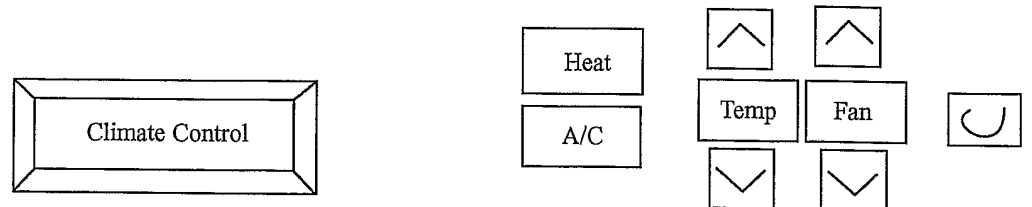

Figure 20

INTERNATIONAL SEARCH REPORT

International application No.

PCT/US03/35308

A. CLASSIFICATION OF SUBJECT MATTER

IPC(7) : G05B 15/00; H03K 17/94
 US CL : 700/83; 341/22

According to International Patent Classification (IPC) or to both national classification and IPC

B. FIELDS SEARCHED

Minimum documentation searched (classification system followed by classification symbols)
 U.S. : 700/83; 341/22

Documentation searched other than minimum documentation to the extent that such documents are included in the fields searched

Electronic data base consulted during the international search (name of data base and, where practicable, search terms used)

C. DOCUMENTS CONSIDERED TO BE RELEVANT

Category *	Citation of document, with indication, where appropriate, of the relevant passages	Relevant to claim No.
Y	US 4,988,981 A (ZIMMERMAN et al.) 29 January 1991 (29.01.1991), see whole document.	1-12
Y	US 6,201,484 B1 (RUSSELL) 13 March 2001 (13.03.2001), see whole document.	1-12
Y	US 5,581,484 A (PRINCE) 03 December 1996 (03.12.1996), see whole document.	1-12
Y, P	US 6,600,480 B2 (NATOLI) 29 July 2003 (29.06.2003), see whole document.	1-12
Y, P	US 6,611,252 B2 (DUFAUX) 26 August 2003 (26.08.2003), see whole document.	1-12
Y, E	US 6,670,894 B2 (MEHRING) 30 December 2003, (30.12.2003), see whole document.	1-12

Further documents are listed in the continuation of Box C.

See patent family annex.

* Special categories of cited documents:	
"A" document defining the general state of the art which is not considered to be of particular relevance	"T" later document published after the international filing date or priority date and not in conflict with the application but cited to understand the principle or theory underlying the invention
"E" earlier application or patent published on or after the international filing date	"X" document of particular relevance; the claimed invention cannot be considered novel or cannot be considered to involve an inventive step when the document is taken alone
"L" document which may throw doubts on priority claim(s) or which is cited to establish the publication date of another citation or other special reason (as specified)	"Y" document of particular relevance; the claimed invention cannot be considered to involve an inventive step when the document is combined with one or more other such documents, such combination being obvious to a person skilled in the art
"O" document referring to an oral disclosure, use, exhibition or other means	
"P" document published prior to the international filing date but later than the priority date claimed	"&" document member of the same patent family

Date of the actual completion of the international search

02 March 2004 (02.03.2004)

Date of mailing of the international search report

11 MAR 2004

Name and mailing address of the ISA/US

Mail Stop PCT, Attn: ISA/US
 Commissioner for Patents
 P.O. Box 1450
 Alexandria, Virginia 22313-1450

Facsimile No. (703) 305-3230

Authorized officer

Anil Khatri *James R. Matthews*

Telephone No. 703-305-4700