



US00D783101S

(12) **United States Design Patent**
Schweigert

(10) **Patent No.:** **US D783,101 S**

(45) **Date of Patent:** **** Apr. 4, 2017**

(54) **GOLF CLUB HEAD**

4,754,977 A 7/1988 Sahn
4,869,507 A 9/1989 Sahn
D335,317 S 5/1993 Shearer
D335,692 S 5/1993 Antonious

(Continued)

(71) Applicant: **PARSONS XTREME GOLF, LLC**,
Scottsdale, AZ (US)

(72) Inventor: **Bradley D. Schweigert**, Anthem, AZ
(US)

FOREIGN PATENT DOCUMENTS

(73) Assignee: **PARSONS XTREME GOLF, LLC**,
Scottsdale, AZ (US)

JP 2005/160691 A 6/2005

(**) Term: **15 Years**

OTHER PUBLICATIONS

(21) Appl. No.: **29/550,730**

U.S. Appl. No. 14/586,720, Parsons et al., "Golf Club Heads and Methods to Manufacture Golf Club Heads," filed Dec. 30, 2014.

(Continued)

(22) Filed: **Jan. 6, 2016**

Primary Examiner — Mitchell Siegel

Related U.S. Application Data

(57) **CLAIM**

(60) Division of application No. 29/542,980, filed on Oct. 20, 2015, now Pat. No. Des. 750,186, which is a continuation-in-part of application No. 29/541,175, filed on Sep. 30, 2015, now abandoned, which is a continuation-in-part of application No. 29/538,456, filed on Sep. 3, 2015, now abandoned.

The ornamental design for a golf club head, as shown and described.

DESCRIPTION

(51) **LOC (10) Cl.** **21-02**

(52) **U.S. Cl.**
USPC **D21/736**

(58) **Field of Classification Search**
USPC D21/736-746, 759
CPC A63B 53/065; A63B 53/0487; A63B 53/00
See application file for complete search history.

FIG. 1 is a top perspective view of a golf club head;
FIG. 2 is a bottom perspective view of the golf club head of FIG. 1;
FIG. 3 is a front elevational view of the golf club head of FIG. 1;
FIG. 4 is a rear elevational view of the golf club head of FIG. 1;
FIG. 5 is a top view of the golf club head of FIG. 1;
FIG. 6 is a bottom view of the golf club head of FIG. 1;
FIG. 7 is a right side view of the golf club head of FIG. 1;
and,
FIG. 8 is a left side view of the golf club head of FIG. 1.
The broken lines are included for the purpose of illustration only. None of the broken lines forms part of the claimed design.

(56) **References Cited**

U.S. PATENT DOCUMENTS

922,444 A 5/1909 Youds
RE19,178 E 5/1934 Spiker
4,043,562 A 8/1977 Shillington

1 Claim, 6 Drawing Sheets

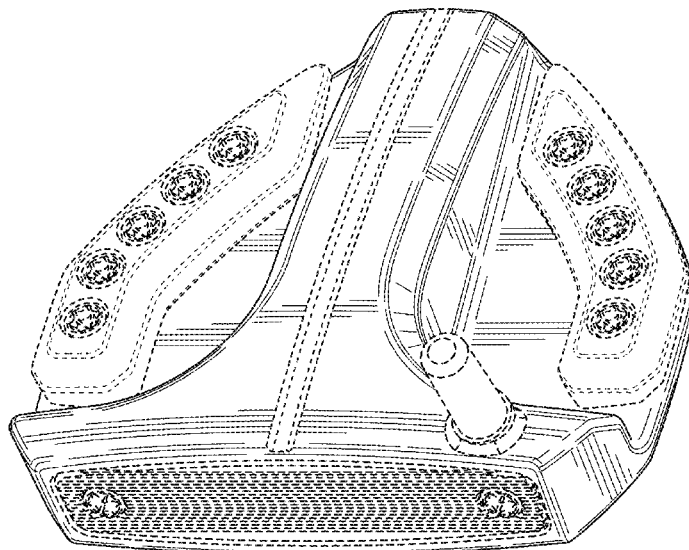

(56)

References Cited

U.S. PATENT DOCUMENTS

D336,757 S	6/1993	Antonious	D579,995 S	11/2008	Nicolette et al.
D350,582 S	9/1994	Miansian et al.	D582,497 S	12/2008	Rollinson
5,429,366 A	7/1995	McCabe	7,473,189 B2	1/2009	Schweigert et al.
D363,101 S	10/1995	Sturm	7,491,131 B2*	2/2009	Vinton A63B 53/0487 473/251
D365,864 S	1/1996	Sturm	D595,793 S *	7/2009	Rollinson D21/736
5,489,097 A	2/1996	Simmons	D599,425 S	9/2009	Laub
D368,751 S	4/1996	Rife	D600,763 S	9/2009	Cameron
D369,393 S	4/1996	Takahashi et al.	7,744,485 B2	6/2010	Jones et al.
5,571,053 A	11/1996	Lane	D620,993 S	8/2010	Laub
D378,688 S	4/1997	Cameron	D621,461 S *	8/2010	Serrano D21/742
D385,609 S	10/1997	Cameron	D623,709 S	9/2010	Serrano et al.
5,683,307 A	11/1997	Rife	D631,925 S	2/2011	Broom
D388,143 S	12/1997	Huan-Chiang	7,887,432 B2	2/2011	Jones et al.
D389,207 S	1/1998	Cameron	7,909,707 B2	3/2011	Klein
D398,685 S	9/1998	Masuda	7,918,745 B2	4/2011	Morris et al.
D399,290 S	10/1998	Sizemore, Jr.	D638,891 S	5/2011	Nicolette et al.
D399,911 S	10/1998	Nicolette et al.	D642,643 S	8/2011	Nicolette et al.
5,839,974 A	11/1998	McAllister	D643,485 S	8/2011	Nicolette et al.
D405,836 S	2/1999	Nicolette et al.	D645,104 S	9/2011	Nicolette et al.
D409,701 S	5/1999	Ashcraft et al.	8,096,039 B2	1/2012	Soracco et al.
5,924,938 A	7/1999	Hines	D653,718 S	2/2012	Stokke et al.
D422,655 S	4/2000	Hicks	D661,753 S	6/2012	Cameron et al.
D426,276 S	6/2000	Besnard et al.	D666,260 S	8/2012	Cynn
D431,854 S	10/2000	Cameron	8,376,878 B2	2/2013	Bennett et al.
D432,192 S	10/2000	Hicks	D688,339 S	8/2013	Hilton et al.
D436,151 S	1/2001	Nicolette et al.	D688,341 S	8/2013	Rollinson
D437,374 S	2/2001	Cameron	D691,226 S	10/2013	Hilton et al.
D441,820 S	5/2001	Nicolette et al.	D699,308 S	2/2014	Rollinson
D443,668 S	6/2001	Nicolette et al.	D704,782 S	5/2014	Rollinson
D443,905 S	6/2001	Nicolette et al.	8,721,472 B2	5/2014	Kuan et al.
D444,833 S	7/2001	Wells et al.	8,790,193 B2	7/2014	Serrano et al.
6,264,571 B1	7/2001	Lekavich	D711,483 S	8/2014	Wong
D449,664 S	10/2001	Beebe et al.	D715,388 S *	10/2014	Serrano D21/743
D449,865 S	10/2001	Fife, Jr. et al.	D722,350 S *	2/2015	Schweigert D21/735
D450,799 S	11/2001	Nicolette et al.	D722,351 S *	2/2015	Parsons D21/736
D451,973 S	12/2001	Wells et al.	D722,352 S *	2/2015	Nicolette D21/747
6,348,014 B1	2/2002	Chiu	D723,120 S *	2/2015	Nicolette D21/747
6,354,959 B1	3/2002	Nicolette et al.	D724,164 S *	3/2015	Schweigert D21/752
6,394,910 B1	5/2002	McCarthy	D725,208 S *	3/2015	Schweigert D21/743
D472,949 S	4/2003	Serrano	D726,265 S *	4/2015	Nicolette D21/747
D474,821 S	5/2003	Wells et al.	D726,846 S *	4/2015	Schweigert D21/743
D474,949 S	5/2003	Schaffeld et al.	D730,462 S *	5/2015	Becktor D21/742
D483,086 S	12/2003	Schweigert et al.	D732,122 S *	6/2015	Becktor D21/742
D486,872 S	2/2004	Schweigert et al.	D732,618 S *	6/2015	Becktor D21/742
D488,200 S *	4/2004	Olsavsky D21/743	D733,234 S *	6/2015	Nicolette D21/752
D498,276 S	11/2004	Schweigert et al.	D738,447 S	9/2015	Schweigert
6,902,496 B2	6/2005	Solheim et al.	D738,449 S *	9/2015	Schweigert D21/759
D512,116 S	11/2005	Miraflor et al.	D739,487 S	9/2015	Schweigert
6,988,956 B2	1/2006	Cover et al.	D741,426 S *	10/2015	Schweigert D21/736
D520,088 S	5/2006	Parr	D748,213 S	1/2016	Parsons et al.
D531,242 S	10/2006	Adams	D748,215 S	1/2016	Parsons et al.
D532,067 S	11/2006	Soracco et al.	D753,252 S	4/2016	Schweigert
7,153,220 B2	12/2006	Lo	2007/0142122 A1	6/2007	Bonneau
D534,595 S	1/2007	Hasebe	2007/0207875 A1	9/2007	Kuan et al.
7,156,752 B1	1/2007	Bennett	2007/0238548 A1	10/2007	Johnson
D536,401 S	2/2007	Kawami	2008/0139333 A1	6/2008	Klein
D536,403 S	2/2007	Kawami	2008/0146372 A1	6/2008	John
D538,371 S	3/2007	Kawami	2008/0176672 A1	7/2008	Roach et al.
7,204,765 B2	4/2007	Cover et al.	2011/0165959 A1	7/2011	Klein
D542,869 S	5/2007	Adams	2013/0165256 A1	6/2013	Stevenson
D543,598 S	5/2007	Kuan et al.	2013/0210537 A1	8/2013	Ainscough et al.
D543,601 S	5/2007	Kawami			
D555,219 S	11/2007	Lin			
D556,277 S	11/2007	Broom			
D561,854 S	2/2008	Morris			
7,331,876 B2	2/2008	Klein			
7,351,162 B2	4/2008	Soracco et al.			
D569,461 S	5/2008	Morris			
D569,930 S	5/2008	Nehrbas			
7,396,289 B2	7/2008	Soracco et al.			
D577,085 S	9/2008	Nicolette et al.			
D577,086 S	9/2008	Nicolette et al.			
D579,506 S	10/2008	Nicolette et al.			

OTHER PUBLICATIONS

U.S. Appl. No. 14/686,466, Schweigert, "Golf Club Head," filed Apr. 14, 2015.

U.S. Appl. No. 29/523,587, Schweigert, "Golf Club Head," filed Apr. 10, 2015.

TourSpecGolf (Gold's Factory Multi Weighted Custom Putter) [online]. Nov. 20, 2010 [retrieved Apr. 21, 2016]. Retrieved from the internet: <URL: <http://www.toursecgolf.com/blog/golds-factory-multi-weighted-custom-putter/>>.

* cited by examiner

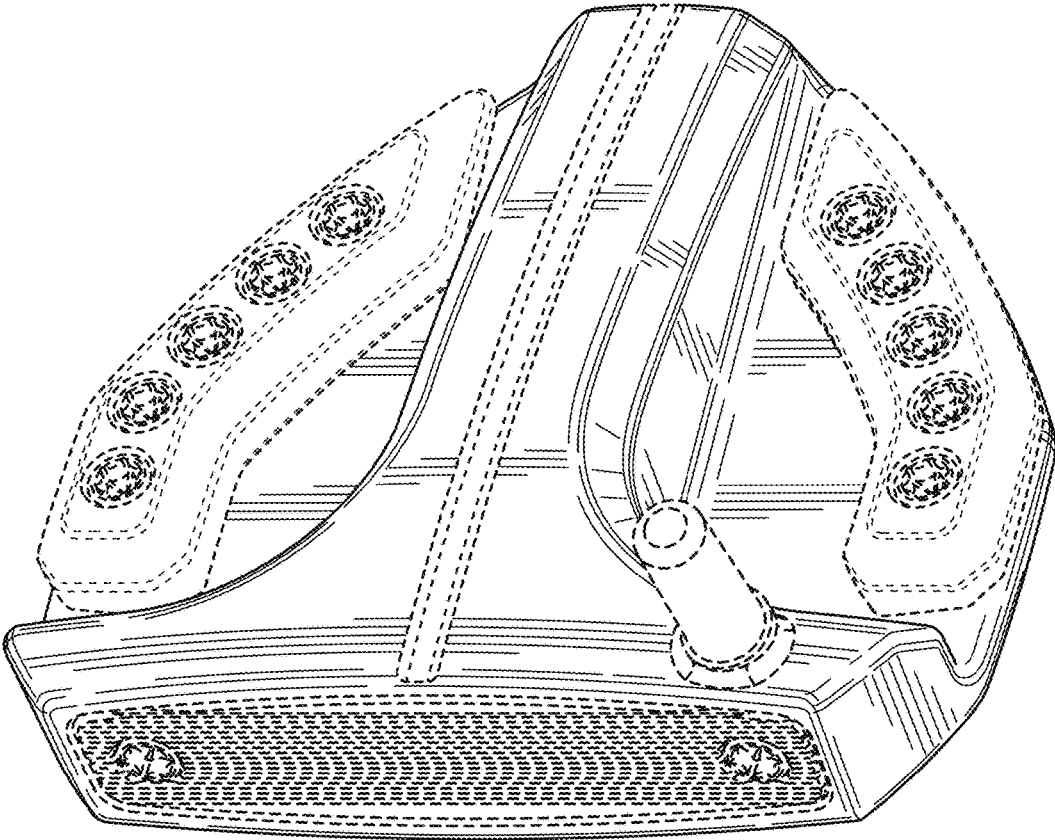

FIG. 1

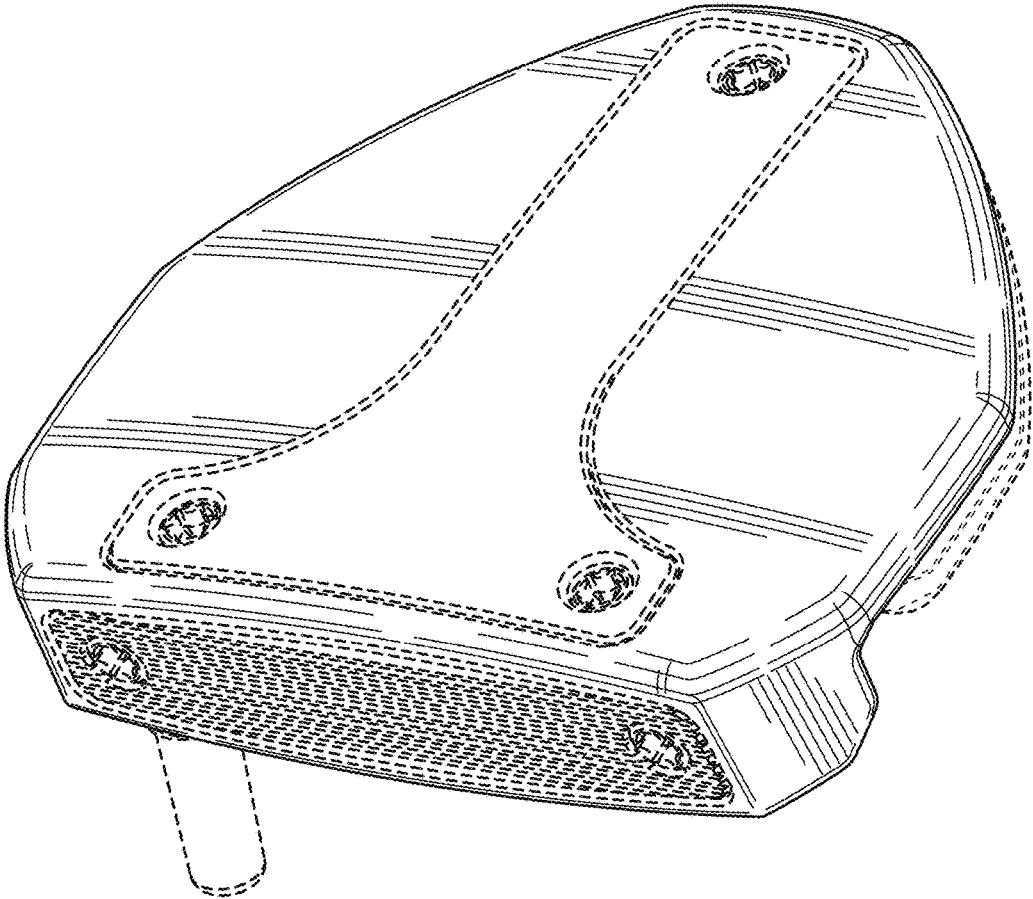

FIG. 2

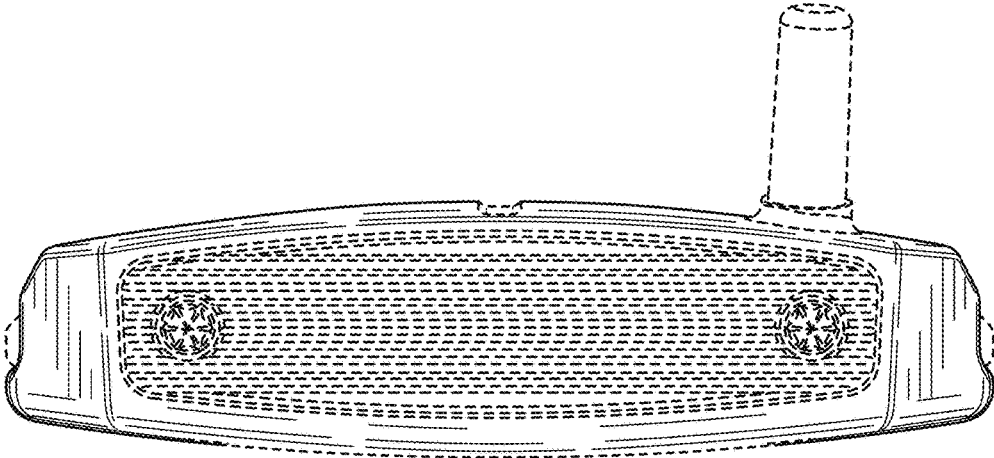

FIG. 3

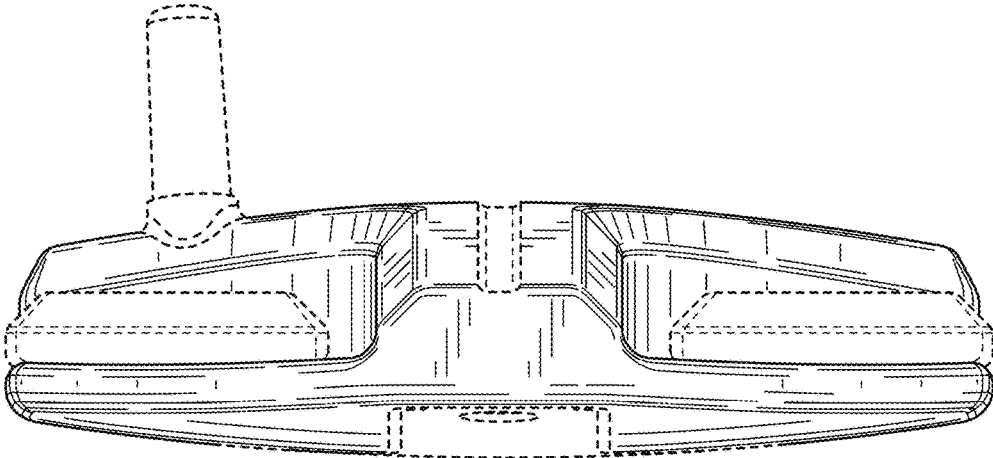

FIG. 4

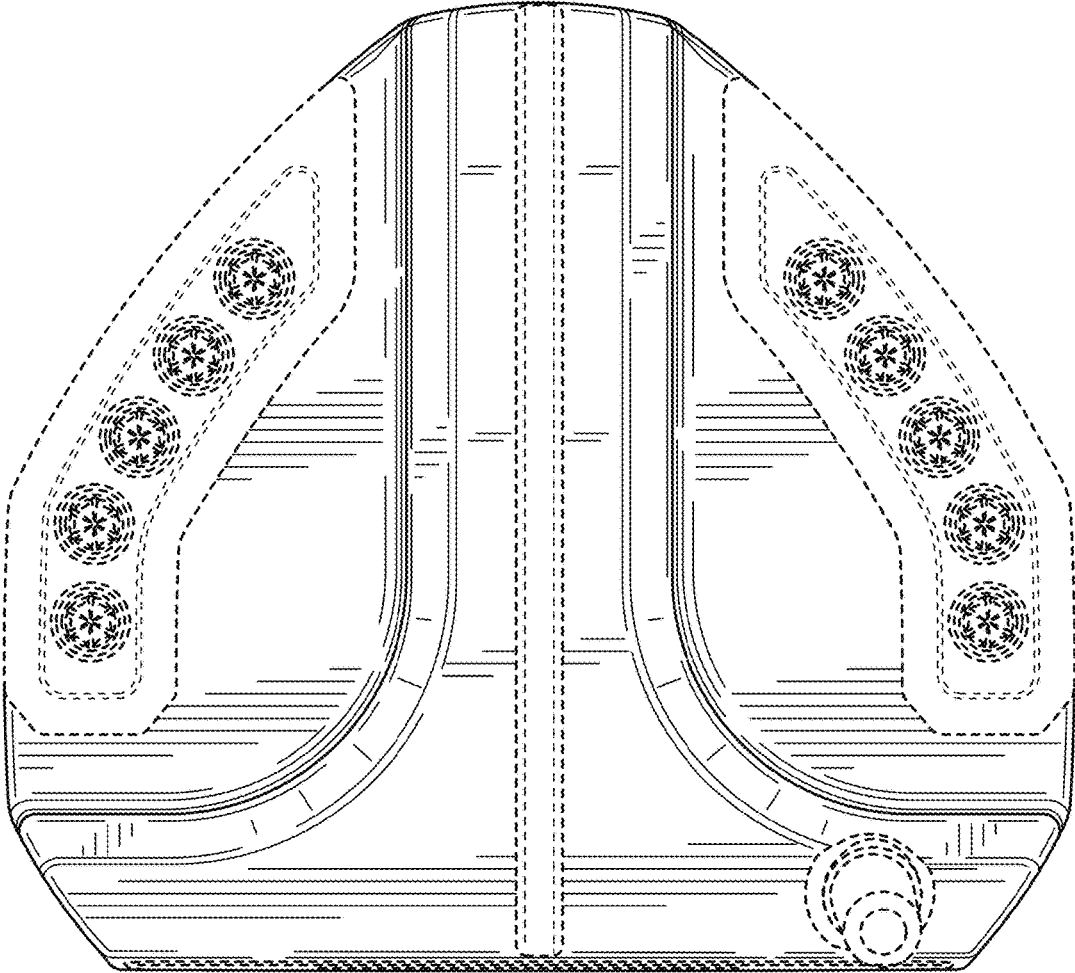

FIG. 5

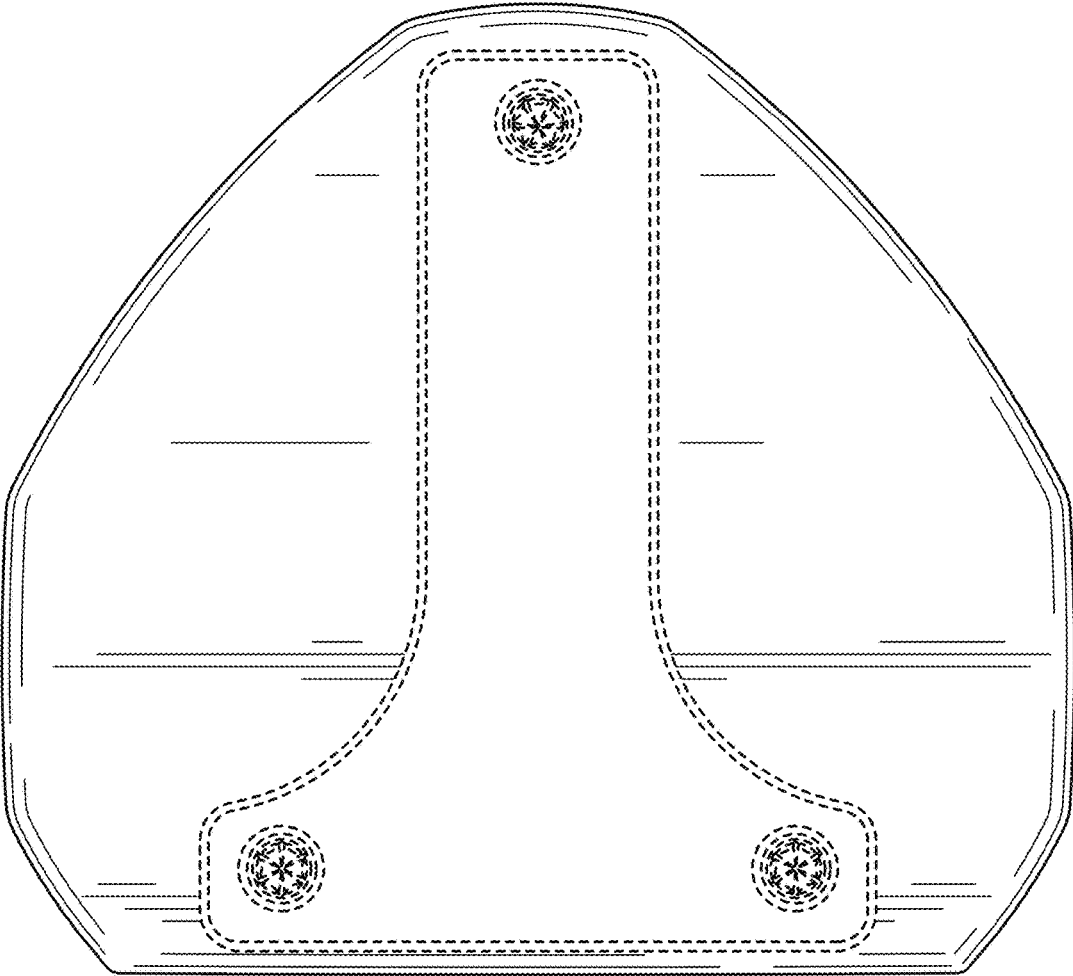

FIG. 6

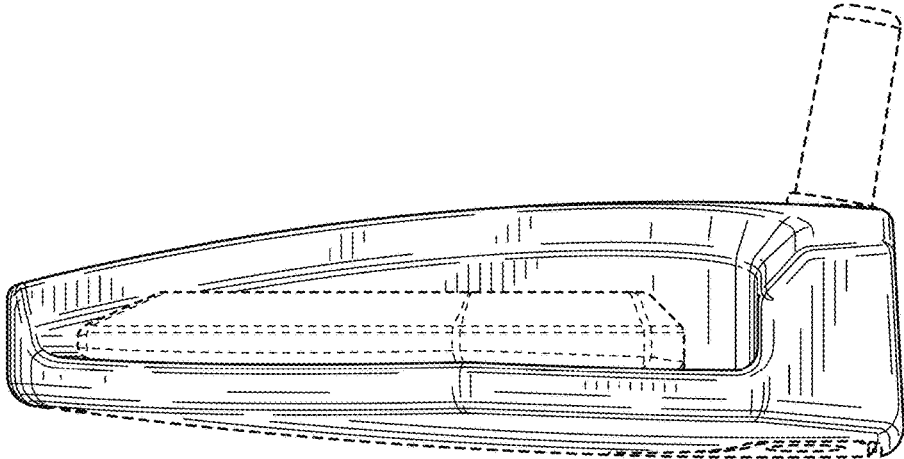

FIG. 7

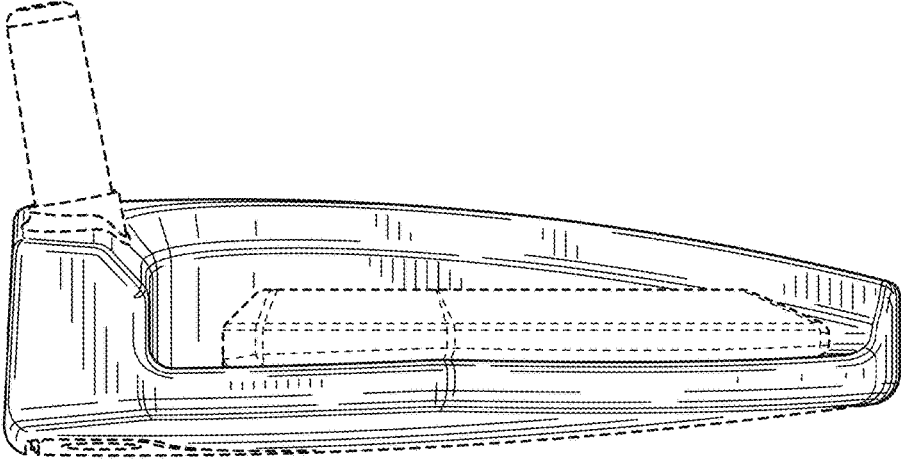

FIG. 8