



US00D725065S

(12) **United States Design Patent**  
**Chung**

(10) **Patent No.:** **US D725,065 S**

(45) **Date of Patent:** **\*\* Mar. 24, 2015**

(54) **PORTABLE TERMINAL**

(71) Applicant: **Samsung Electronics Co., Ltd.**,  
Suwon-si (KR)

(72) Inventor: **James Chung**, Goyang-si (KR)

(73) Assignee: **Samsung Electronics Co., Ltd.**,  
Suwon-si (KR)

(\*\*) Term: **14 Years**

(21) Appl. No.: **29/464,574**

(22) Filed: **Aug. 19, 2013**

(30) **Foreign Application Priority Data**

Feb. 18, 2013 (KR) ..... 30-2013-0008371

(51) **LOC (10) Cl.** ..... **14-03**

(52) **U.S. Cl.**  
USPC ..... **D14/138 G**

(58) **Field of Classification Search**

CPC ..... H04M 1/02; H04M 1/0202-1/035;  
H04M 1/0237; H04M 1/0239; H04M 2250/22;  
H04M 1/03; H04M 1/23; H04M 1/72519;  
H04M 1/0235; G06F 1/1626  
USPC ..... D14/138 G, 138 AD, 138 R, 496, 203.1,  
D14/203.3, 203.5, 203.7, 248, 218, 341,  
D14/138 AC; 455/575.1, 556.1, 556.2,  
455/575.3, 575.4, 566; D21/517, 329, 331;  
379/433.01, 433.04; D13/168;  
361/679.3, 679.56; D10/65, 78

See application file for complete search history.

(56) **References Cited**

U.S. PATENT DOCUMENTS

D578,098 S \* 10/2008 Oh ..... D14/138 AD  
D602,000 S \* 10/2009 Oh et al. .... D14/203.7  
D608,327 S \* 1/2010 Cigliano et al. .... D14/138 AD  
D619,990 S \* 7/2010 Lai ..... D14/138 G  
D632,663 S \* 2/2011 Oh et al. .... D14/138 G

(Continued)

OTHER PUBLICATIONS

Samsung Galaxy Note Edge telephone, announced Sep. 2014, [online], [site visited Oct. 28, 2014]. Available from Internet, <URL: [http://www.gsmarena.com/samsung\\_galaxy\\_note\\_edge-6631.php](http://www.gsmarena.com/samsung_galaxy_note_edge-6631.php)>.\*

(Continued)

*Primary Examiner* — Jeffrey D Asch

(74) *Attorney, Agent, or Firm* — NSIP Law

(57) **CLAIM**

The ornamental design for a portable terminal, as shown and described.

**DESCRIPTION**

FIG. 1 is a front perspective view of a portable terminal showing my new design;

FIG. 2 is a front view thereof;

FIG. 3 is a rear view thereof;

FIG. 4 is a left-side view thereof;

FIG. 5 is a right-side view thereof;

FIG. 6 is a top view thereof;

FIG. 7 is a bottom view thereof;

FIG. 8 is an enlarged view of the encircled portion A as shown in FIG. 2; and,

FIG. 9 is an enlarged view of the encircled portion B as shown in FIG. 4.

The broken lines shown in the figures that are immediately adjacent to the shaded areas and define regions that are consistently unshaded, represent the bounds of the claim, while all other broken lines, including those within the broken line boundaries and those that have been shaded through, are directed to non-claimed environment; the broken lines form no part of the claimed design.

The dot-dash broken lines encircling portions of the claimed design that are illustrated in enlargements form no part of the claimed design.

The shade lines in the figures show contour and not surface ornamentation.

**1 Claim, 6 Drawing Sheets**

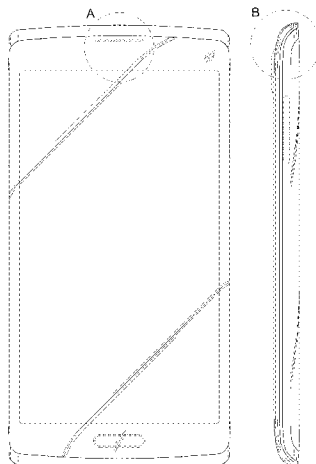

(56)

References Cited

U.S. PATENT DOCUMENTS

D640,578 S \* 6/2011 Aihara et al. .... D10/65  
 D656,477 S \* 3/2012 Yi et al. .... D14/138 G  
 D663,279 S \* 7/2012 Kim et al. .... D14/138 G  
 D667,808 S \* 9/2012 Kim ..... D14/138 G  
 D668,652 S \* 10/2012 Kim et al. .... D14/341  
 D676,440 S \* 2/2013 Kita et al. .... D14/341  
 D680,989 S \* 4/2013 Jeong ..... D14/138 G  
 D681,591 S \* 5/2013 Sung ..... D14/138 G  
 8,477,485 B2 \* 7/2013 Lin et al. .... 361/679.08  
 D687,800 S \* 8/2013 Lee ..... D14/138 G  
 D696,215 S \* 12/2013 Li ..... D14/138 G  
 D698,782 S \* 2/2014 Hong ..... D14/341  
 D699,206 S \* 2/2014 Kim ..... D14/138 G  
 D699,209 S \* 2/2014 Huang ..... D14/138 G  
 D705,188 S \* 5/2014 Chau et al. .... D14/138 G  
 D706,738 S \* 6/2014 Kim et al. .... D14/138 G  
 D709,473 S \* 7/2014 Kim et al. .... D14/138 G  
 D709,847 S \* 7/2014 Huang ..... D14/138 G

D713,810 S \* 9/2014 Boucquey et al. .... D14/138 G  
 D713,812 S \* 9/2014 Hachiya ..... D14/138 G  
 2013/0231165 A1 \* 9/2013 Griffin et al. .... 455/575.8

OTHER PUBLICATIONS

HTC Desire V telephone, announced Jun. 2012, [online], [site visited Oct. 28, 2014]. Available from Internet, <URL: [http://www.gsmarena.com/htc\\_desire\\_v-4805.php](http://www.gsmarena.com/htc_desire_v-4805.php)>.\*  
 HTC Desire X telephone, announced Aug. 2012, [online], [site visited Oct. 28, 2014]. Available from Internet, <URL: [http://www.gsmarena.com/htc\\_desire\\_x-4951.php](http://www.gsmarena.com/htc_desire_x-4951.php)>.\*  
 Acer Liquid Z500 telephone, announced Sep. 2014, [online], [site visited Oct. 28, 2014]. Available from Internet, <URL: [http://www.gsmarena.com/acer\\_liquid\\_z500-6635.php](http://www.gsmarena.com/acer_liquid_z500-6635.php)>.\*  
 Lenovo S820 telephone, announced May 2013, [online], [site visited Oct. 28, 2014]. Available from Internet, <URL: [http://www.gsmarena.com/lenovo\\_s820-5486.php](http://www.gsmarena.com/lenovo_s820-5486.php)>.\*  
 Lava Iris 506Q telephone, announced Sep. 2013, [online], [site visited Oct. 28, 2014]. Available from Internet, <URL: [http://www.gsmarena.com/lava\\_iris\\_506q-6308.php](http://www.gsmarena.com/lava_iris_506q-6308.php)>.\*

\* cited by examiner

FIG.1

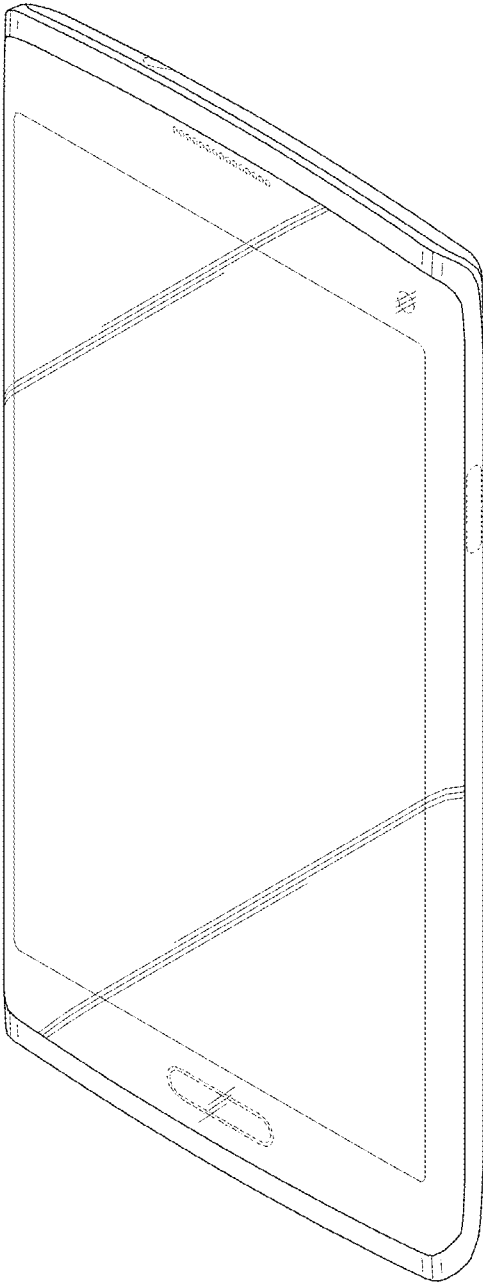

FIG.2

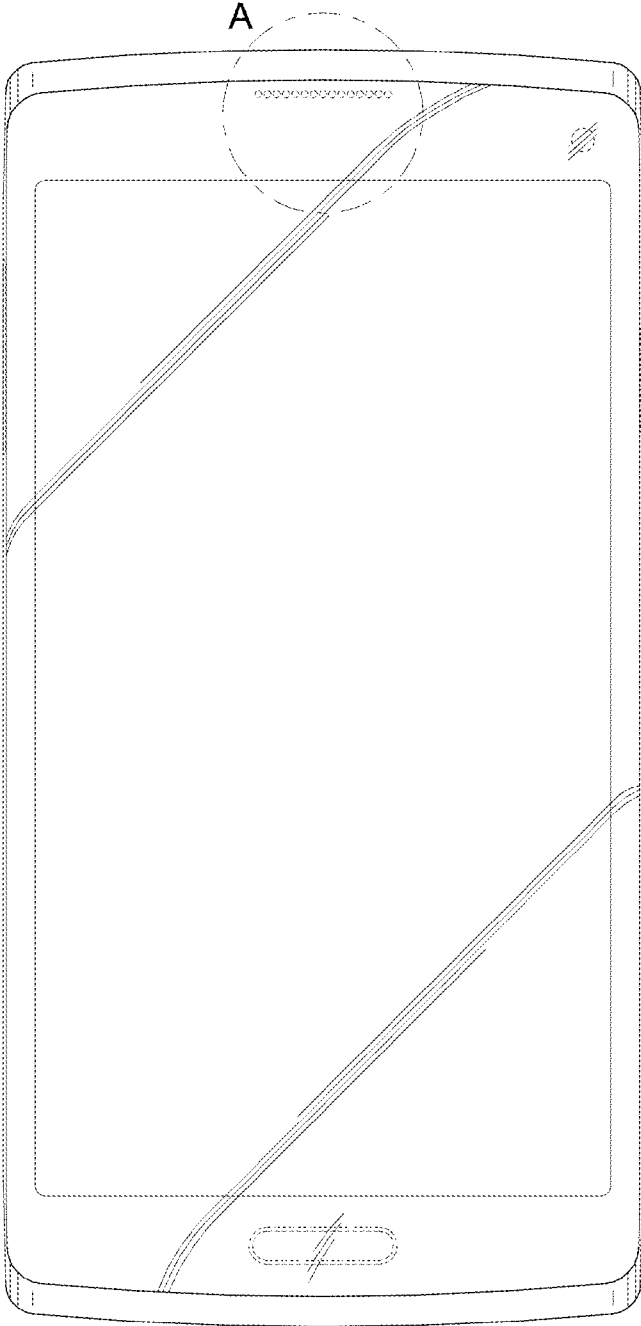

FIG.3

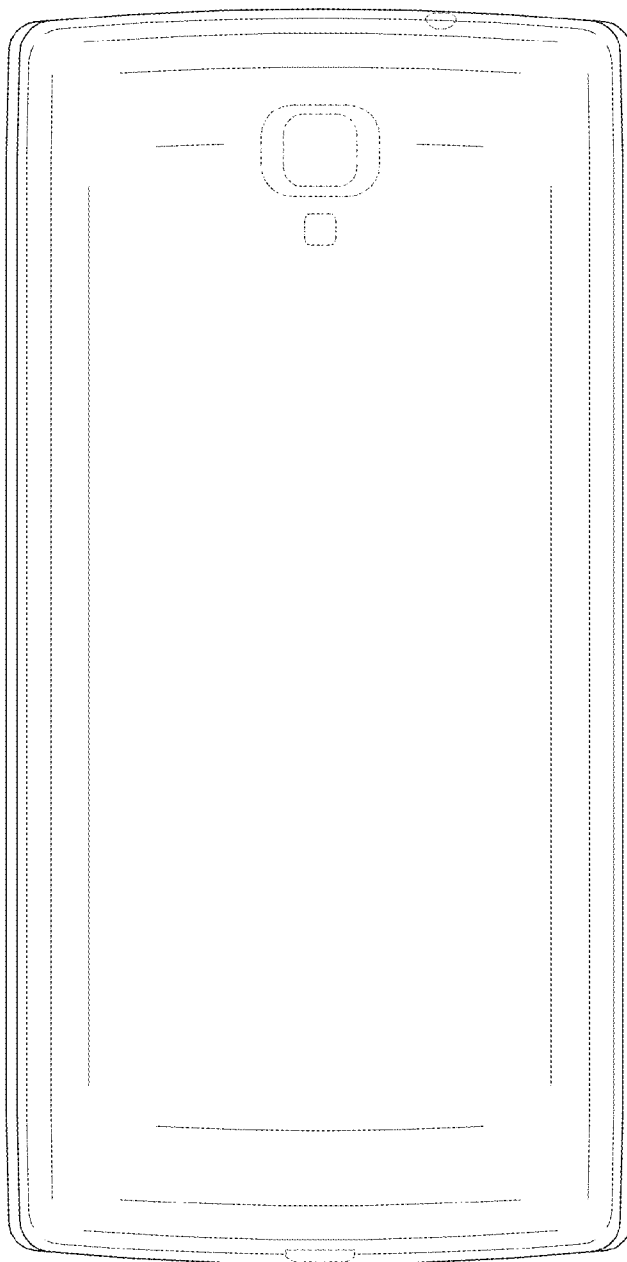

FIG.4

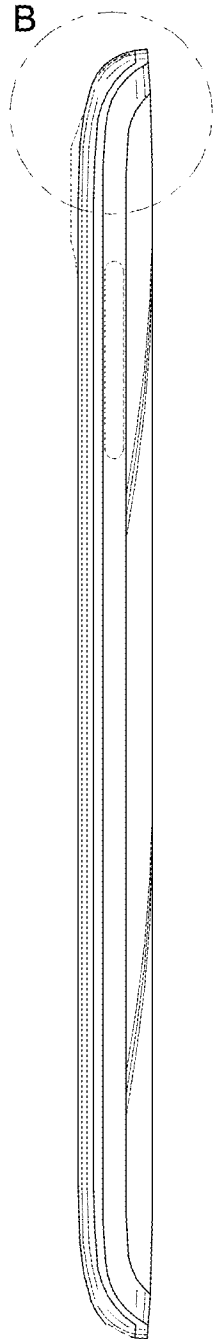

FIG.5

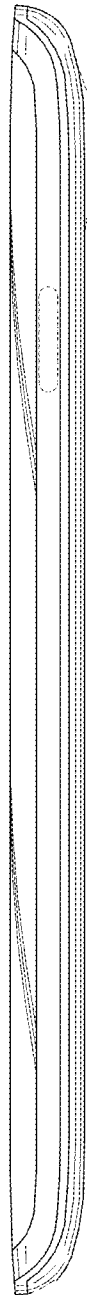

FIG.6

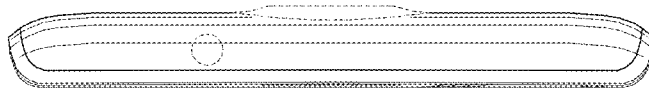

FIG.7

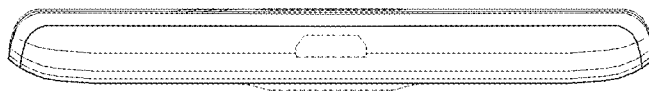

FIG.8

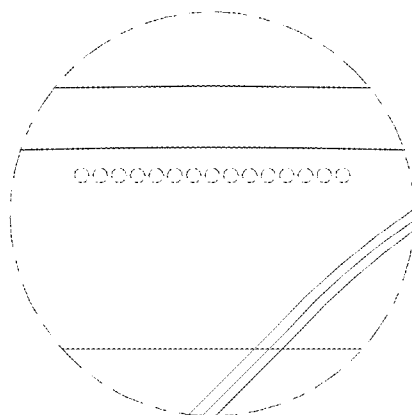

FIG.9

