



US00D359013S

United States Patent [19]
Carlson

[11] **Patent Number: Des. 359,013**
[45] **Date of Patent: ** Jun. 6, 1995**

[54] **PLANTER**
[75] **Inventor: Arthur R. Carlson, East Malvern, Australia**
[73] **Assignee: Bemis Manufacturing Company, Sheboygan Falls, Wis.**
[**] **Term: 14 Years**
[21] **Appl. No.: 906,111**
[22] **Filed: Jun. 26, 1992**
[52] **U.S. Cl. D11/156**
[58] **Field of Search D11/156, 143; D7/609, D7/601; 47/66**

94178 9/1985 Australia .
94632 9/1985 Australia .
94633 9/1985 Australia .
98993 4/1987 Australia .
95997 5/1987 Australia .
96249 5/1987 Australia .
96250 5/1987 Australia .
97364 5/1987 Australia .
99707 5/1987 Australia .
15245 7/1976 New Zealand .
15246 7/1976 New Zealand .
15065 7/1977 New Zealand .
15178 10/1977 New Zealand .
15180 10/1977 New Zealand .
18581 11/1983 New Zealand .
18582 11/1983 New Zealand .

[56] **References Cited**
U.S. PATENT DOCUMENTS
D. 259,868 7/1981 Julinot D11/156
D. 288,793 3/1987 Carlson D11/153
D. 288,794 3/1987 Carlson D11/153
D. 296,425 6/1988 Carlson D11/152
D. 297,319 8/1988 Carlson D11/152
D. 300,732 4/1989 Carlson D11/152
D. 313,203 12/1990 Carlson D11/153

FOREIGN PATENT DOCUMENTS

69915 8/1978 Australia .
69505 6/1979 Australia .
78936 9/1979 Australia .
79915 12/1979 Australia .
79916 12/1979 Australia .
79917 12/1979 Australia .
81174 6/1980 Australia .
81777 8/1980 Australia .
81778 8/1980 Australia .
83115 1/1981 Australia .
83116 1/1981 Australia .
90136 11/1983 Australia .
90137 11/1983 Australia .
90138 11/1983 Australia .
90286 11/1983 Australia .
90287 11/1983 Australia .
90290 11/1983 Australia .
90291 11/1983 Australia .
90288 4/1985 Australia .
90289 4/1985 Australia .

OTHER PUBLICATIONS

Tupperware Catalog, Dec. 1974, item #72.

Primary Examiner—Alan P. Douglas
Assistant Examiner—Cathron B. Matta
Attorney, Agent, or Firm—Michael, Best & Friedrich

[57] **CLAIM**

The ornamental design for a planter, as shown and described.

DESCRIPTION

FIG. 1 is a perspective view from above of my inventive planter;
FIG. 2 is a perspective view from beneath and other side;
FIG. 3 is a perspective view from above with parts separated;
FIG. 4 is a perspective view from beneath with parts separated;
FIG. 5 is a plan view;
FIG. 6 is a side view;
FIG. 7 is an end view;
FIG. 8 is a cross section 8—8;
FIG. 9 is a plan view of planter with insert removed;
FIG. 10 is an underneath view;
FIG. 11 is a side view of insert;
FIG. 12 is an end view thereof with the planter not shown in order to completely show the insert; and,
FIG. 13 is an underneath view thereof.

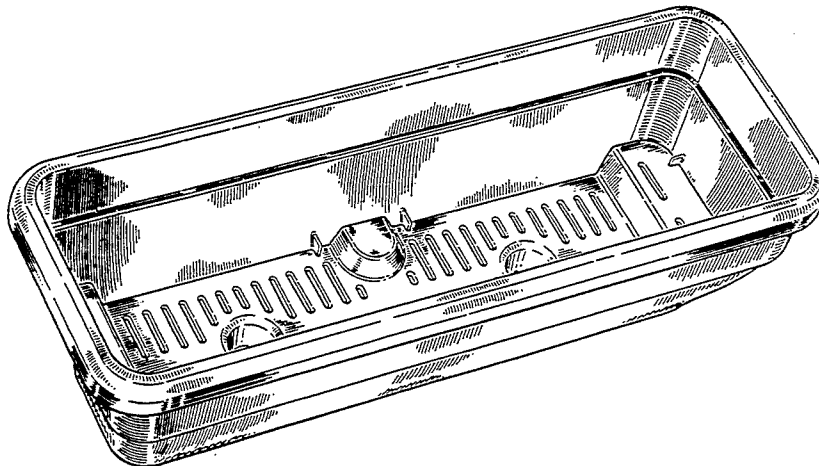

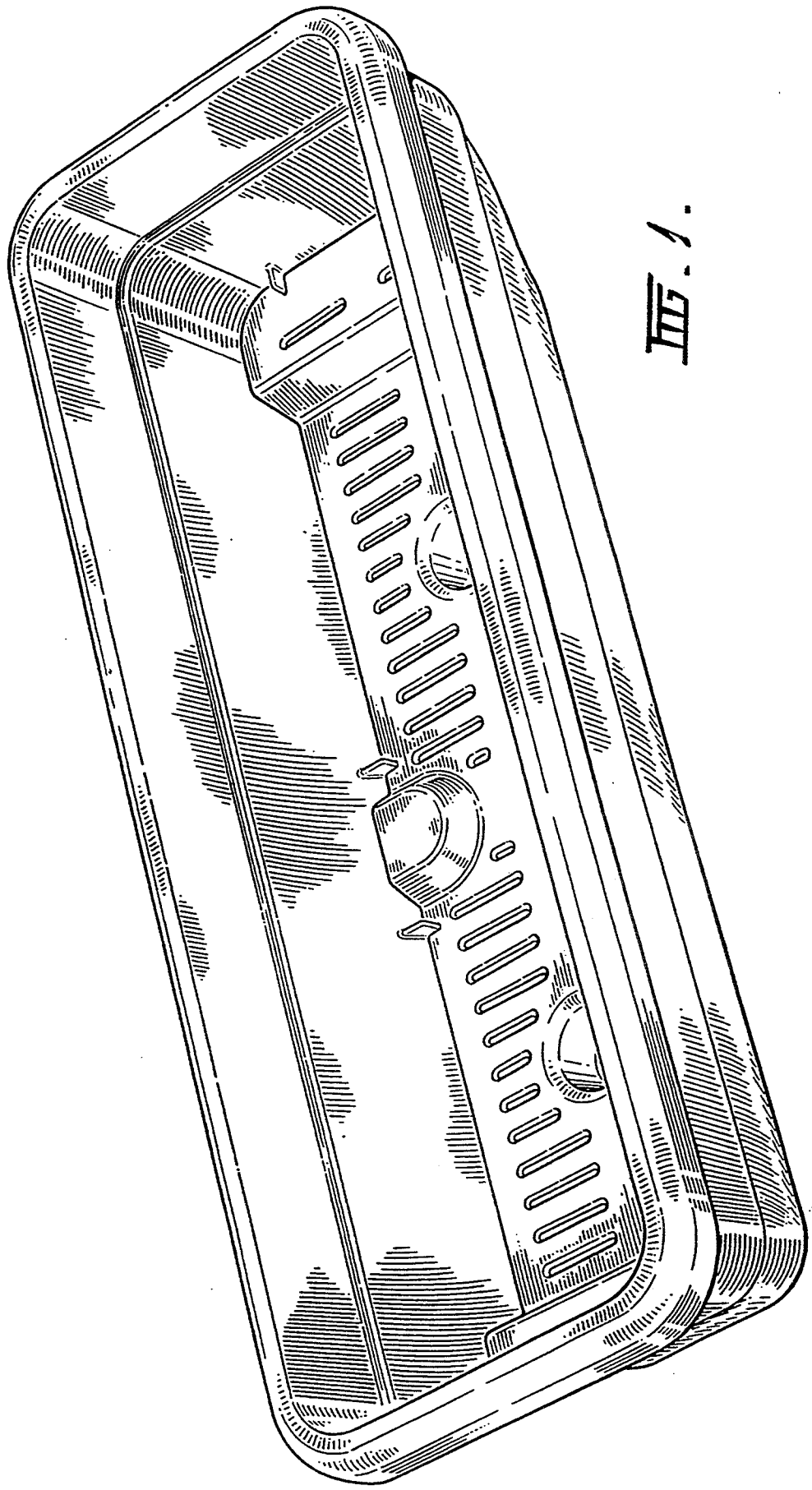

FIG. 1.

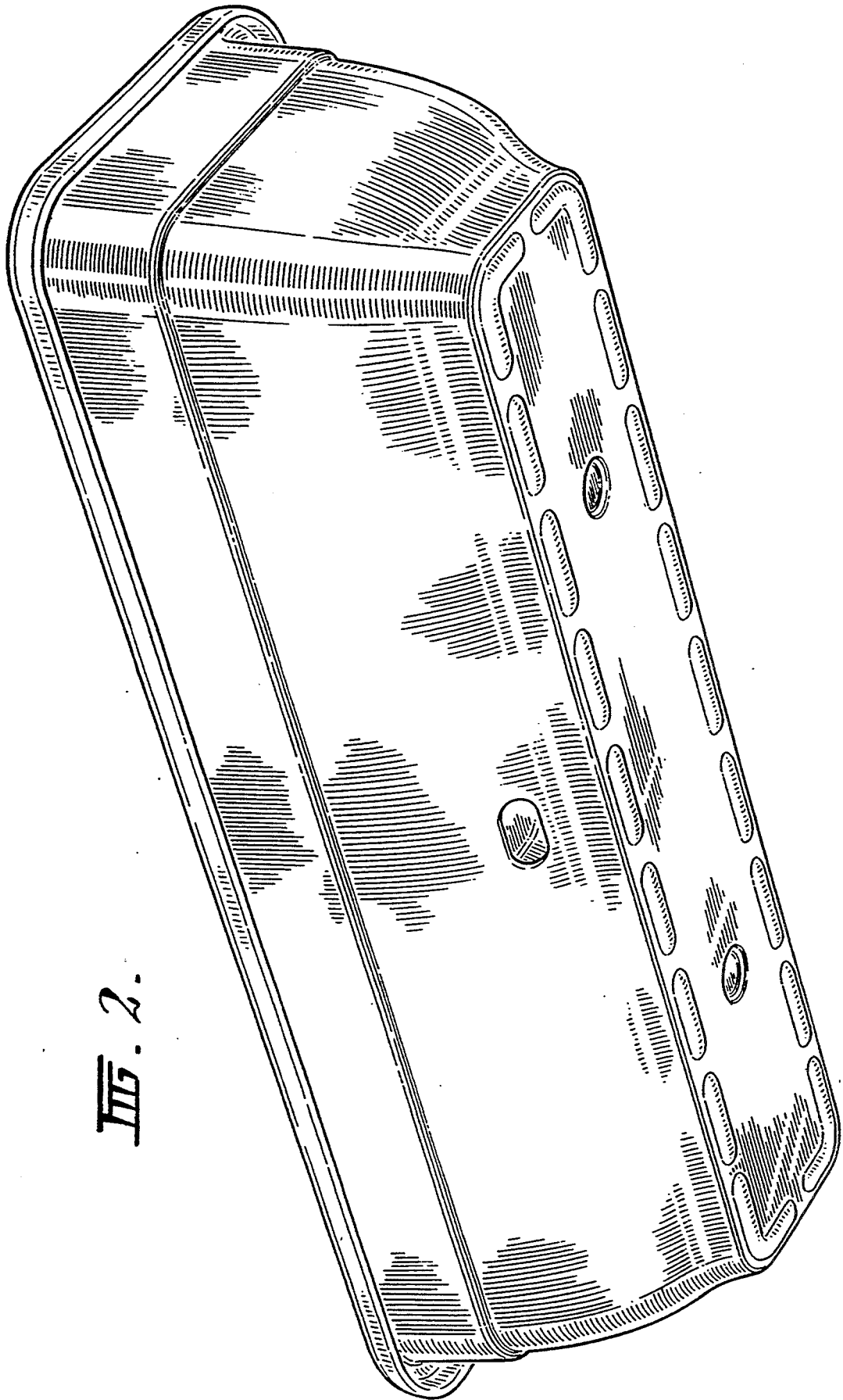
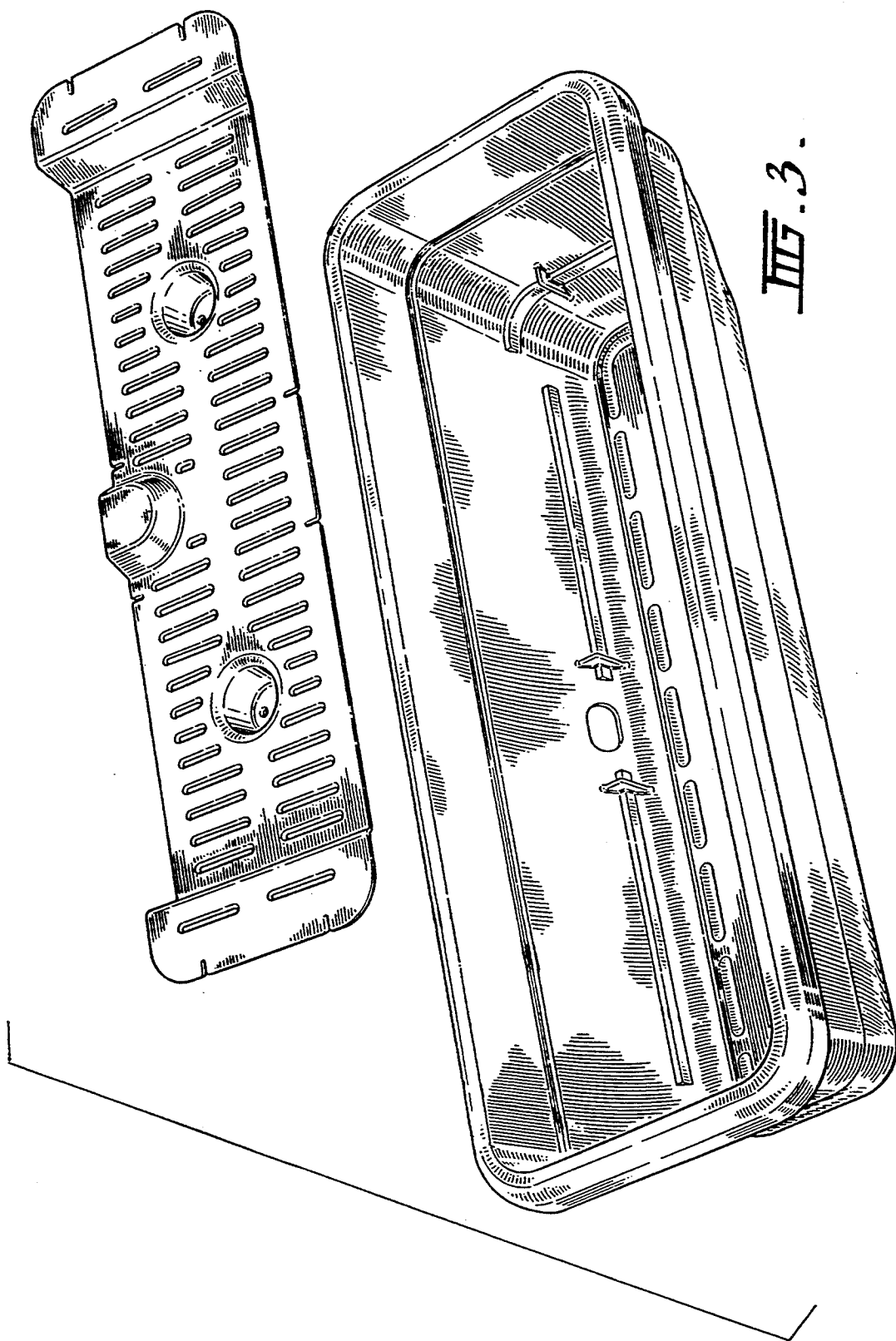

FIG. 2.



III-3.

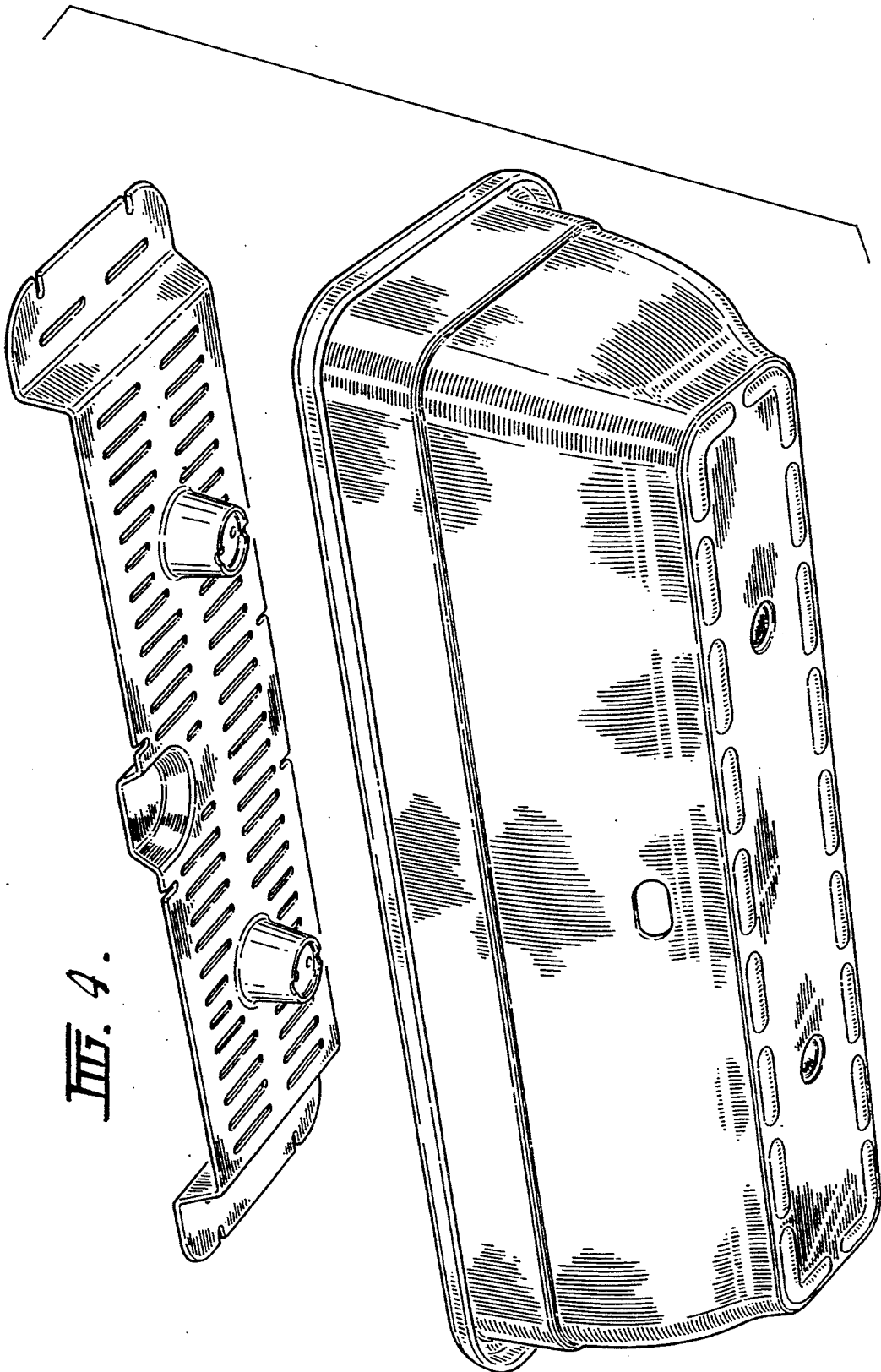

FIG. 4.

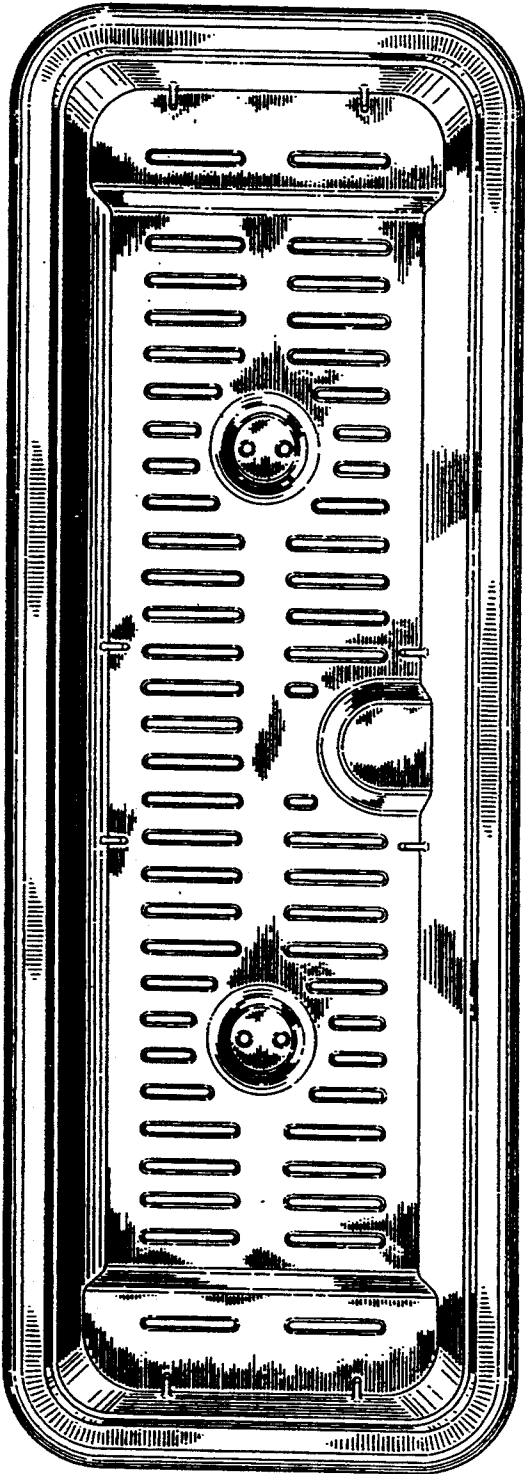

FIG. 5.

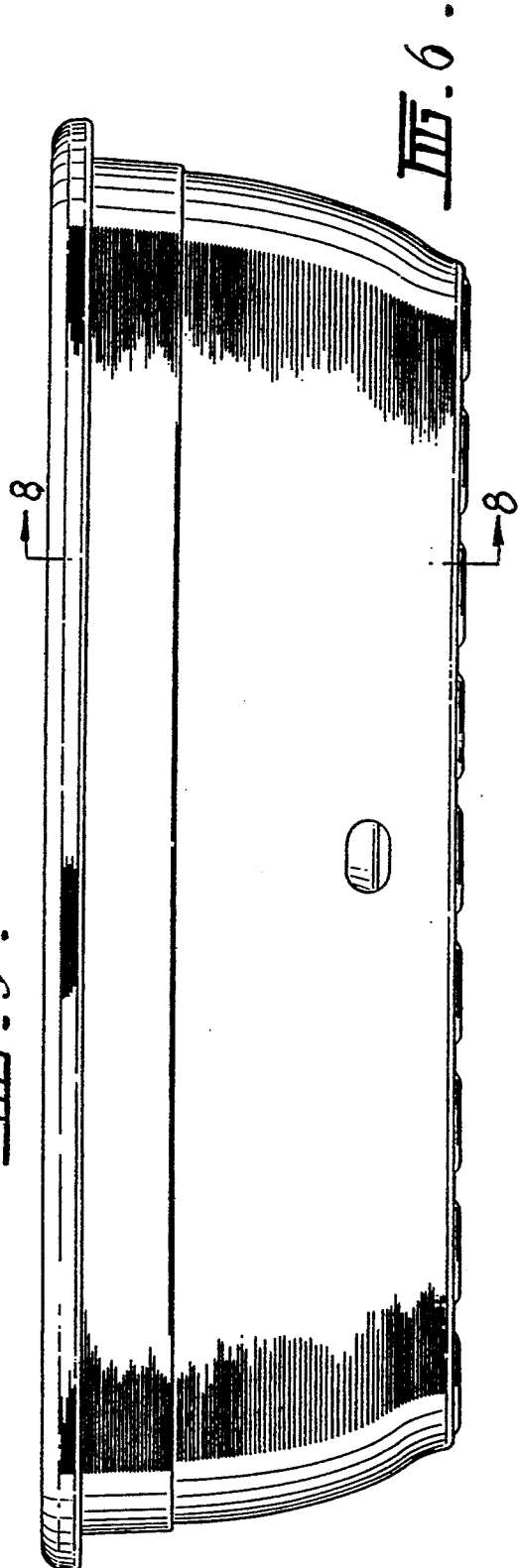

FIG. 6.

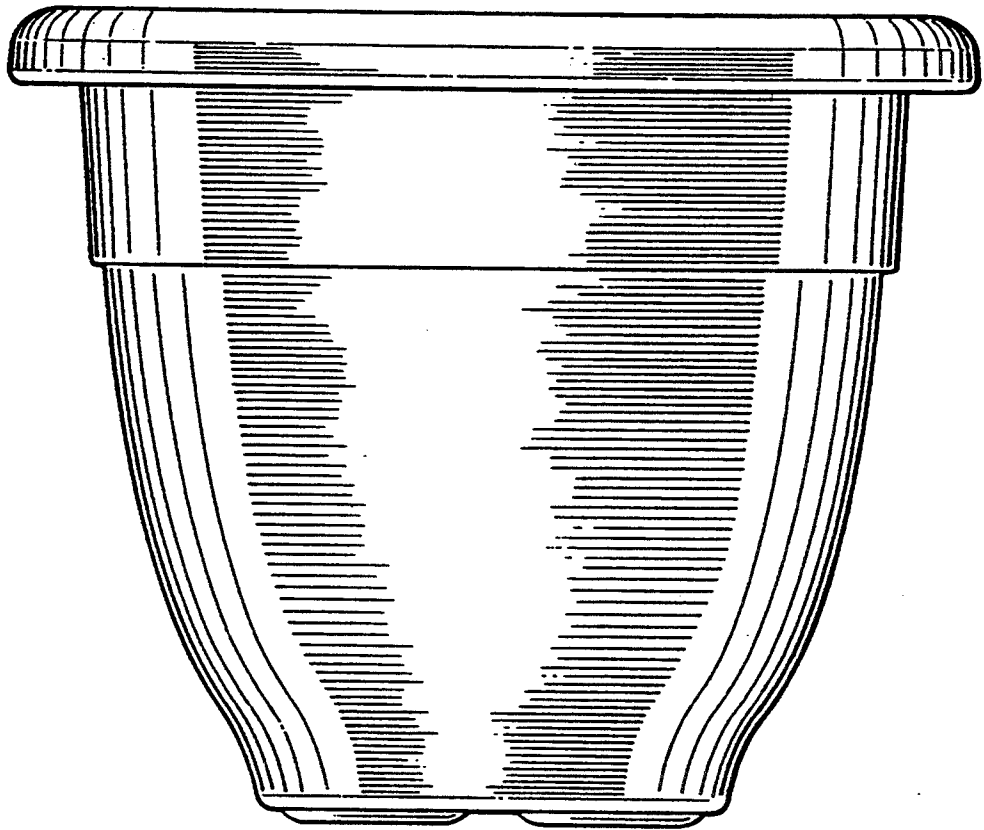

FIG. 7.

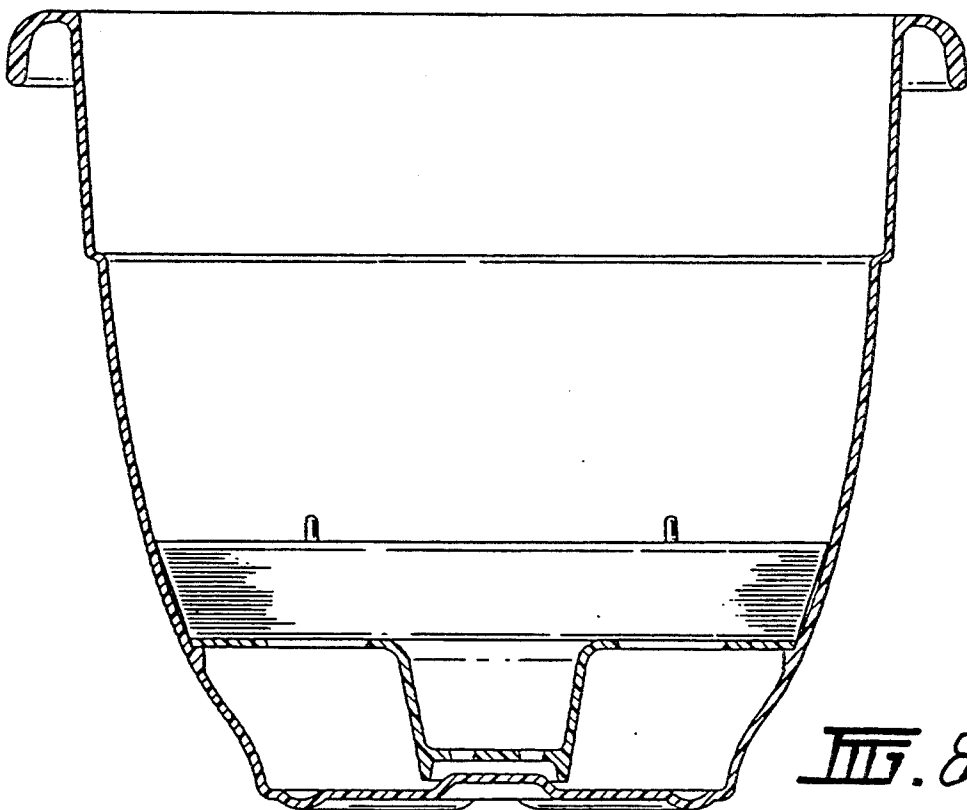

FIG. 8.

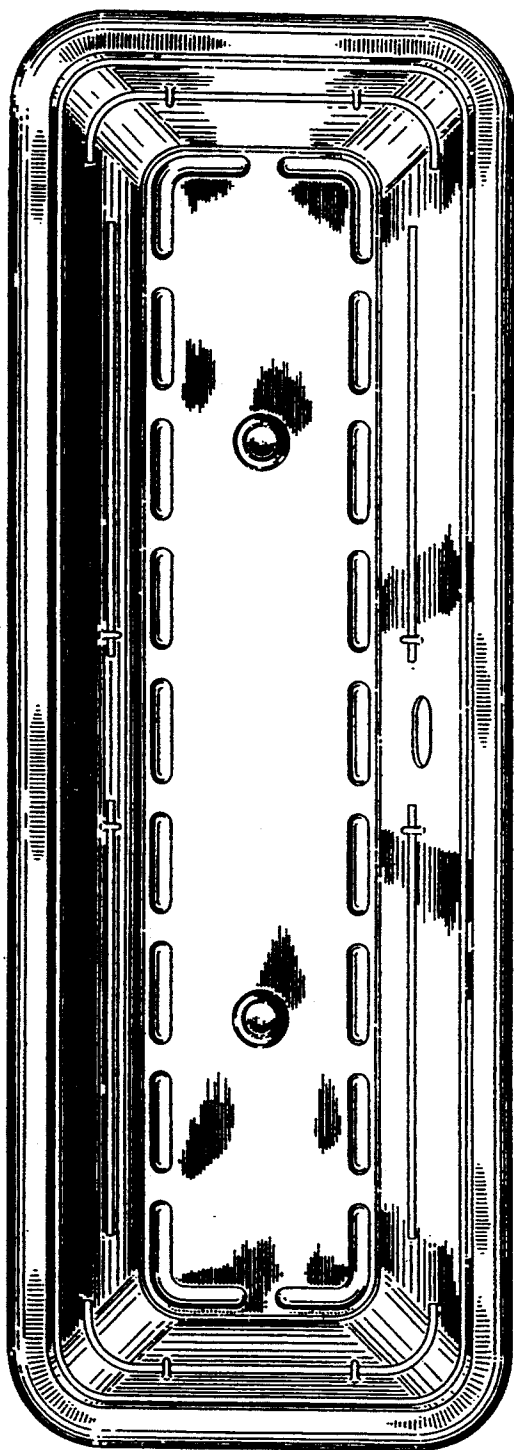

FIG. 9.

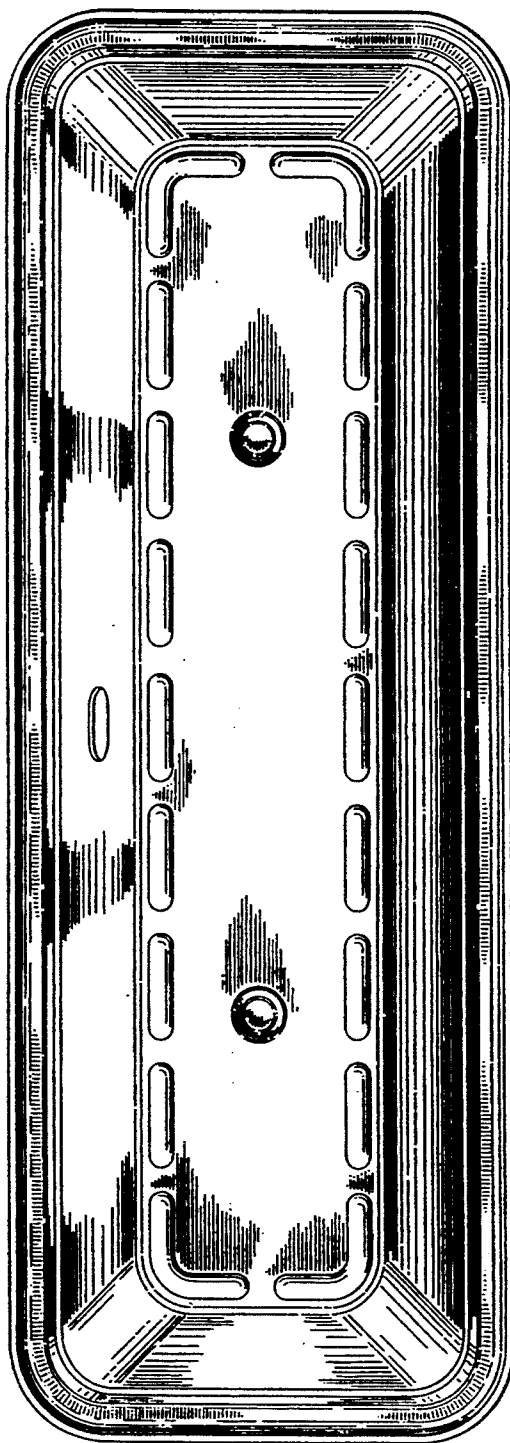

FIG. 10.

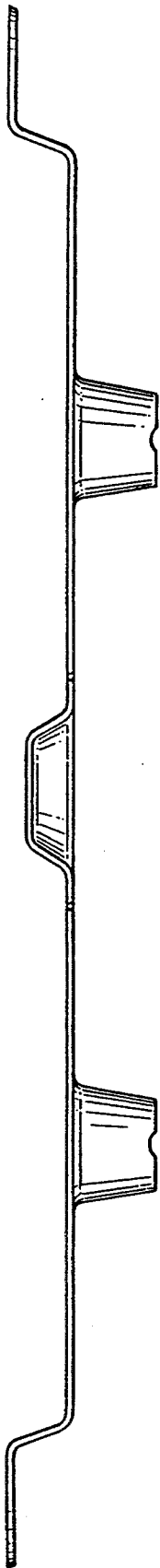

FIG. 11.

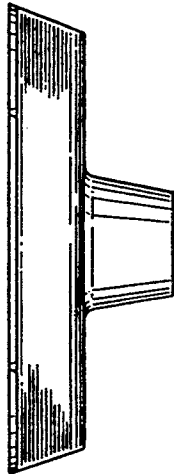

FIG. 12.

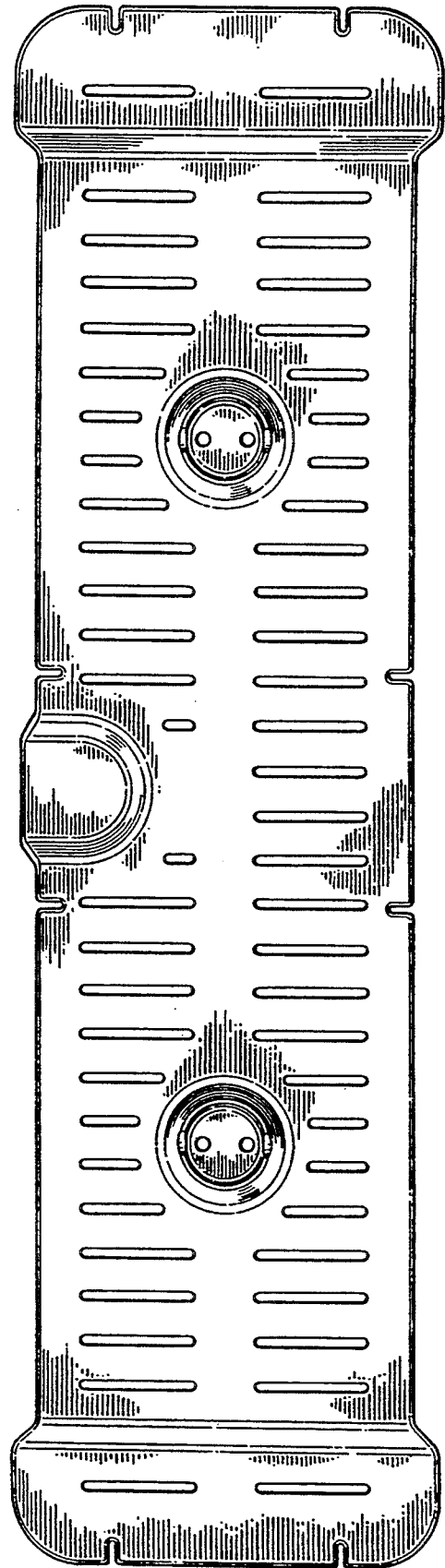

FIG. 13.