

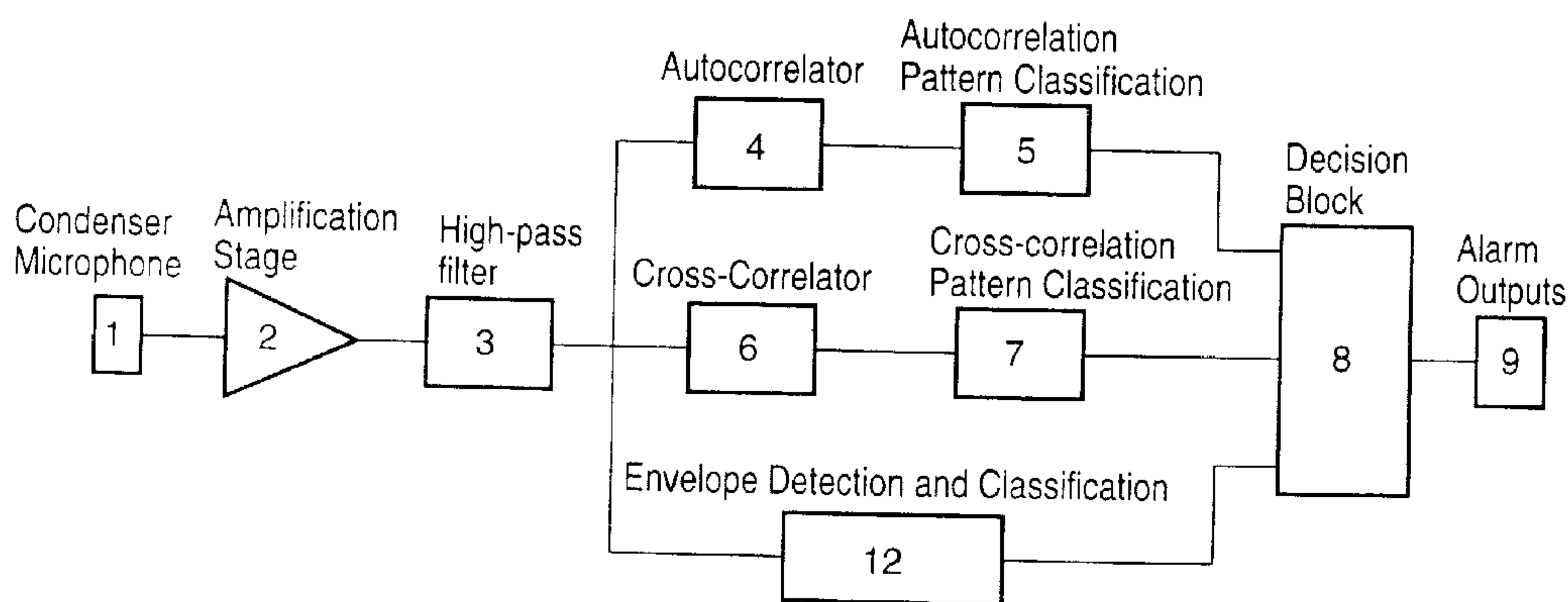

(72) Cecic, Dennis, CA  
(72) Fong, Hartwell, CA  
(73) DIGITAL SECURITY CONTROLS LTD., CA  
(51) Int.Cl.<sup>5</sup> G08B 13/22, G08B 13/04  
(54) **DETECTEUR DE VERRE BRISE**  
(54) **DETECTION OF GLASS BREAKAGE**



(57) A glass shattering detector and method for detecting breaking glass take advantage of the characteristics of high frequency components of a glass shattering signal which can be statistically recognized. In contrast to most non-glass breaking transient events, the higher frequency components are wide-band and random and, based on these characteristics, can be distinguished from many non-glass break event transient signals.

2117053

ABSTRACT OF THE DISCLOSURE

A glass shattering detector and method for detecting breaking glass take advantage of the characteristics of high frequency components of a glass shattering signal which can be statistically recognized. In contrast to most non-glass breaking transient events, the higher frequency components are wide-band and random and, based on these characteristics, can be distinguished from many non-glass break event transient signals.

TITLE: DETECTION OF GLASS BREAKAGEFIELD OF THE INVENTION

The present invention relates to a glass break  
5 detector for detecting the shattering of glass as well as a  
method used by a glass break detector for detecting the  
shattering of glass.

BACKGROUND OF THE INVENTION

10 There are a number of existing glass break  
detectors, however, to date these detectors have not been  
entirely effective. The most significant problem to be  
solved by a glass break detector is the elimination of the  
occurrence of false alarms. Most of the prior art glass  
15 break detectors have recognized that there are low  
frequency components of a glass break signal. These low  
frequency components are often referred to as the "thud"  
associated with the initial force which leads to flexure of  
the glass and the subsequent shattering of the glass. The  
20 low frequency vibration of the glass and the subsequent low  
frequency vibration of the surrounding supporting  
structure, typically the glass frame, dominates these  
components. The prior art has also recognized that there  
are high frequency components between 4kHz and  
25 approximately 8kHz.

Some of the prior art systems have tried to  
categorize the glass break event by analyzing the amplitude  
and/or frequency of the signal. Some of these prior art  
structures have focused on a portion of the glass break  
30 signal at approximately 6.5kHz while other systems have  
looked to timing relationships between the low frequency  
"thud" components and higher frequency components of a  
predetermined amplitude. The main problem with the prior  
art is the inability of the system to distinguish glass  
35 break events from non-glass break events. Common false  
alarms are caused by thunder, dropping metal objects,  
ringing of bells, service station bells, chirping birds,

slamming doors, splintering wood and mouse traps. These sources have both low frequency components and high frequency components somewhat similar to a glass break event.

5           An improved alarm detection arrangement for detecting glass breakage is proposed herein which is more reliable and can more readily distinguish glass break events from many non-glass break events which previously caused false alarms.

10

#### SUMMARY OF THE INVENTION

          A glass break detector according to the present invention detects the breaking of glass based on the non-deterministic characteristics of high frequency components  
15 of the signal and other characteristics which distinguish the signal from non-glass break transient events.

          A glass break detector, according to an aspect of the present invention, detects the breaking of glass and comprises an acoustic transducer which is capable of  
20 producing a wide-band electrical signal, a processing arrangement for removing low frequency components and identifying changes in the electrical signal caused by a transient high amplitude non-deterministic signal, and an alarm arrangement which produces an alarm signal when a  
25 transient high amplitude non-deterministic signal is detected.

          According to a preferred aspect of the invention, the processing arrangement of the glass break detector, includes an initial high-pass filter for eliminating low  
30 frequency components below about 1kHz.

          A glass break detector, according to the present invention, comprises an acoustical transducer responsive to acoustic pressure and, based thereon, produces an electrical output signal, a filter for removing low  
35 frequency components of the output electrical signal typically associated with the initial force leading to a glass break event and passing high frequency components of

the output electrical signal, and a processing arrangement which uses statistical techniques for analyzing the high frequency components of the output signal for characteristics indicative of a glass break event and which collectively distinguish the output from non-glass break events, and producing an alarm signal when said characteristics are present.

According to a preferred aspect of the invention, the glass break detector includes a reference signal as part of the processing means which is cross-correlated with the higher frequency components of the output electrical signal for assessing whether the output electrical signal has characteristics indicative of a glass break event. The reference signal is representative of the higher frequency components of a glass break event and can be an actual glass break event or can be a fabricated approximation of a typical higher frequency components of a glass break event.

A glass break detector and a method of detecting glass breakage advantageously analyzes high frequency components of transient events recorded by an acoustic transducer. It has been found that when high frequency components, caused by a transient event, is wide-band and random in nature for a duration typical of a glass break event, a glass break event has been detected. The normal non-glass break transient events, which previously were a source of false alarms in prior art sensors, tend to be periodic or narrow band and as such can be distinguished, preferably statistically from an actual glass break event. Other techniques can be used in combination with the above to improve the reliability of the prediction.

A method of detecting the breaking of glass, according to the present invention, comprises sensing acoustical pressure and producing an electrical signal representative of the sensed acoustical pressure and identifying sudden changes in the signal caused by transient events. Statistical techniques are used for assessing the randomness of high frequency components of

the signal resulting from the sudden changes and producing an alarm signal when a sudden change is detected and the high frequency components thereof can be statistically determined to be representative of a glass break event.

5           According to an aspect of the invention, the electrical signal is passed through a high-pass filter, which filters out frequencies less than about 1kHz.

          According to a further aspect of the invention, the method uses a cross-correlation statistical technique for  
10 comparing the the higher frequency components of the output signal with a reference glass break signal.

#### BRIEF DESCRIPTION OF THE DRAWINGS

          Preferred embodiments of the invention are shown in  
15 the drawings, wherein:

          Figure 1 is a block diagram of the glass break detector;

          Figure 2A shows a sample pattern representing a filtered glass break event used as a reference signal in  
20 cross-correlation analysis to distinguish glass break events;

          Figure 2B is a plot of the integral of the absolute value of the cross-correlation output of the sample pattern to itself. This is the highest plot and other signals that  
25 may be caused by glass signal events can be compared therewith;

          Figure 3 shows the autocorrelation function (lower graph) when the input to that function is a filtered glass break event produced by breaking a 3mm annealed glass  
30 sample 18" x 18" not broken in a frame (upper graph);

          Figure 4 is a graph of the sample signal of Figure 3, followed by a graph of the cross-correlation output, followed by the integral of the absolute value of the cross-correlation output;

35           Figure 5 is a graph of a filtered glass break signal representative of breaking 4mm tempered glass 18" x

18" not broken in a frame, followed by a graph of the output of the autocorrelation function for this sample;

Figure 6 is a graph of the sample signal of Figure 5, followed by a graph of the cross-correlation output, followed by the integral of the absolute value of the cross-correlation output;

Figure 7 is a graph of a glass break signal representative of breaking 7mm wired glass sample 18" x 18" broken in a frame, followed by a graph of the output of the autocorrelation function for this sample;

Figure 8 is a graph of the sample signal of Figure 7, followed by a graph of the cross-correlation output, followed by the integral of the absolute value of the cross-correlation output;

Figure 9 is a graph of a glass break signal representative of breaking 6mm laminated glass sample 18" x 18" broken in a frame, followed by a graph of the output of the autocorrelation function for this sample;

Figure 10 is a graph of the sample signal of Figure 9, followed by a graph of the cross-correlation output, followed by the integral of the absolute value of the cross-correlation output;

Figure 11 is a graph of a filtered signal from a precision noise generator, followed by a graph of the output of the autocorrelation function for this sample;

Figure 12 is a graph of the sample signal of Figure 11, followed by a graph of the cross-correlation output, followed by the integral of the absolute value of the cross-correlation output;

Figure 13 is a graph of a 4000Hz sine wave signal, followed by a graph of the output of the autocorrelation function for this sample;

Figure 14 is a graph of the sample signal of Figure 13, followed by a graph of the cross-correlation output, followed by the integral of the absolute value of the cross-correlation output;

Figure 15 is a graph of a filtered sample signal produced by dropping a wrench on a hard floor, followed by a graph of the output of the autocorrelation function for this sample;

5           Figure 16 is a graph of the sample signal of Figure 15, followed by a graph of the cross-correlation output, followed by the integral of the absolute value of the cross-correlation output;

10           Figure 17 is a graph of a telephone set ring signal, followed by a graph of the output of the autocorrelation function for this sample;

15           Figure 18 is a graph of the sample signal of Figure 17, followed by a graph of the cross-correlation output, followed by the integral of the absolute value of the cross-correlation output;

            Figure 19 is a graph of a thunder storm signal, followed by a graph of the output of the autocorrelation function for this sample;

20           Figure 20 is a graph of the sample signal of Figure 19, followed by a graph of the cross-correlation output, followed by the integral of the absolute value of the cross-correlation output;

25           Figure 21 is a graph of a human voice producing the sound "pshhhhhh", followed by a graph of the output of the autocorrelation function for this sample;

            Figure 22 is a graph of the sample signal of Figure 21, followed by a graph of the cross-correlation output, followed by the integral of the absolute value of the cross-correlation output; and

30           Figure 23 is a graph of a mixed noise and 4000Hz sine wave signal, followed by a graph of the output of the autocorrelation function for this sample.

2117053

DETAILED DESCRIPTION OF THE PREFERRED EMBODIMENTS

A glass break event, when detected by a microphone, produces a sudden change in the output electrical signal. The output electrical signal has low frequency components generally below 1kHz, and higher frequency components thereabove. The higher frequency components are well represented in the range of 1kHz to 12kHz (12kHz is typical about the upper limit of a microphone). The low frequency components includes the sounds produced by vibration of the window frame and the surrounding structure when a glass break event occurs. The higher frequency components, generally between 1kHz and 12kHz, are generally indicative of the sound produced by the shattering or fracturing of the glass. These higher frequency components have been found to be non-deterministic (wide-band or random) in nature (i.e. low periodicity) and the envelope of these components generally follows an exponential decay type function.

The present inventors have investigated the frequency distribution of the higher frequency components and have determined that these components are non-deterministic. The components are wide-band and do not repeat for different glass breaks, even if the same type and size of glass is used. Close inspection of the higher frequency components reveal that there is a high degree of randomness in the amplitude and there is only low periodicity of the high frequency components. Although the glass break event is quite unpredictable, this characteristic can be used to distinguish a glass break event from signals which commonly cause false alarms, such as dropping wrenches, bells, thunder, ringing phones, etc., which have relatively high periodicity throughout the signal and are more predictable.

The glass break event, particularly when the higher frequency components are analyzed alone, is highly random in nature and this characteristic of the signal is used to distinguish it from typical non-glass break transient event

2117053

signals. In order to quantify the degree of randomness and periodicity in the input signal, statistical techniques are used and found to be highly efficient in distinguishing the higher frequency components from common non-glass break  
5 false alarm signals. By investigating the higher frequency components alone, improved analysis is possible, since the low frequency components are reduced and thus, the dynamic range available to the signal of interest is increased. Analysis established that the higher frequency components  
10 of a glass break event were very unpredictable, however, overall, the signal was wide-band, random and generally had a rapid rise followed by an exponential decay envelope.

It was also found that the low frequency components signal associated with the structural vibrations only  
15 tended to mask the differences between the higher frequency components and the typical sources of false alarms, and therefore, the entire system was improved by filtering out the low frequency components, leading to improved reliability of the statistical analysis.

20 In order to carry out the statistical analysis, the signal is first processed by filtering to remove the low frequency components, followed by sampling of the signal and statistical analysis thereof. In particular, the signal is analyzed using correlation techniques, in  
25 particular cross-correlation and autocorrelation are used. Autocorrelation accurately extracts periodicity in the signal, and in a glass shattering event, the higher frequency components are found to have no significant periodicity (i.e. random). The cross-correlation technique  
30 is used in combination with a typical glass shattering high frequency reference signal (Figure 2A) and this alone, in many cases, is able to distinguish sudden changes in the signal caused by a glass break event from other transient non-glass break events. For improved reliability, two  
35 different means of analysis of the signal are used (i.e. cross-correlation and autocorrelation).

2117053

As shown in Figure 1, the system includes a condenser microphone 1, an amplifier generally shown as 2, a high-pass filter 3 fed in parallel to an autocorrelator generally shown as 4, a cross-correlator generally shown as 5 6, and an envelope detection function 12. The autocorrelator 4 in combination with the autocorrelation and pattern classification arrangement 5 determines the degree of periodicity (low periodicity indicates a high degree of randomness), the cross-correlator 6 in 10 combination with cross-correlator pattern classification arrangement 7 provides analysis relative to the filtered reference glass shattering signal (Figure 2A), and the envelope detection and classification 12 assesses the signal for the typical initial rapid increase associated 15 with glass shattering followed by a nonlinear decay similar to an exponential type decay. These outputs can then be fed to the decision block 8 and, based on the various criteria thereof, alarm outputs 9 will be produced.

This separate processing of the high frequency 20 components using at least two statistical procedures has been effective in distinguishing glass shattering events from common sources of false alarms.

The condenser microphone is a transducer which converts the nearby air pressure fluctuations into an 25 electrical output signal which is processed by the detector. Its frequency response is approximately uniform from 50 Hz to 12kHz, where the response drops off sharply. The transducer is the predominant frequency selection device in this system, although other arrangements can be 30 used.

The high-pass filter 3 and amplifier 2 filters and amplifies the microphone electrical output signal to prepare it for analysis. The high-pass filtering is used to eliminate the high amplitude, periodic, low frequency 35 components of the glass break event, thereby preserving dynamic range and allowing only the higher frequency components of the glass break event to be passed to the

2117053

remaining algorithms or functions. The low frequency components partially depend on location, type of frame used to hold the glass, and the size of the glass pane. Therefore, these low frequency components are difficult to distinguish from common sources of false alarms. By eliminating the low frequency components, the confidence of prediction is increased since the higher frequency components of the actual glass shattering event will occupy the majority of the available dynamic range of the system. The filter is preferably a "Butterworth" type with a smooth amplitude response and linear phase delay in the pass band.

The amplified higher frequency components of the output signal are analyzed by the autocorrelator 4. In theory, the correlator performs an N-sample autocorrelation of the higher frequency components. The mathematical operation performed on the higher frequency components sample is given by:

$$R_{xx}(\xi) = \lim(T \rightarrow \infty) \quad 1/T \int_0^T x(t) x(t + \xi) dt$$

The autocorrelation function computes the average product of a signal, "x(t)" and a time-shifted version of itself, "x(t + ξ)", over a particular period of time, "T". The arithmetic summation performed by the autocorrelation function causes unrelated (random, or uncorrelated) current and future signal components to cancel each other out, leaving behind the periodic (or correlated) components from the input signal. This technique has been utilized for many years in communications receivers, which must extract signals buried in noise. Due to the noise cancelling feature of this function, engineers have used this technique to extract frequency domain information without resorting to operations in the frequency domain (i.e. Fast Fourier Transform (FFT) analysis). By performing statistics on the zero-crossing periods of the

2117053

autocorrelation output, extract periodicity information can be extracted from the input signals. Some examples of autocorrelation are shown in Figures 3, 5, 7, 9, 11, 13, 15, 17 and 19.

5           The various graphs of the cross-correlation and autocorrelation of the various signals are based on a sample period of approximately 186 milliseconds and 8192 samples. The time between samples is approximately 22.7 microseconds.

10           In order to allow comparison between the various graphs, the amplitude ranges of all signals and correlation plots are all scaled relative to the maximum values in the original data.

15           The third graph shown with respect to the cross correlation function of the various samples is a rudimentary post processing mechanism developed to distinguish glass break events from non-glass break events using the cross-correlation output. The scaling for this plot was derived to be relative to the maximum of the  
20 integrated cross-correlation output between the pattern and itself (this situation being the condition of maximum agreement).

25           In summary, the autocorrelation function or an approximation thereof is used to extract the "wide-bandness" of input signals, and in doing so, provides immunity to many false alarm causing sounds, which are periodic in nature (as shown in Figures 13, 25, 17, 19 and 21). However, there may be situations where there is a large source of air turbulence in the protected area. This  
30 may produce whistling noises (see Figure 22), which are random in nature. This necessitates the need for a "second opinion" correlation mechanism, which computes the degree of correlation of the input signal to a stored reference signal representative of a higher frequency components of a  
35 glass break event which has non-deterministic characteristics and of a certain envelope pattern. A single criterion is not particularly satisfactory in

2117053

declaring a transient event a glass shattering event, however, with two or more criteria which confirm one matter, a much higher confidence level is realized.

As can be seen, the glass break signal, when  
5 processed by the autocorrelation function (Fig. 3, 5, 7 and 9), has characteristics exemplified by the wide-band nature of the glass shattering signal. This feature, in combination with the cross-correlator (see Fig. 4, 6, 8 and 10), has been used to accurately distinguish glass  
10 shattering events from other common transient events which previously have caused false alarms, such as those indicated in Figures 12 through 23.

Cross-correlation alone, in some cases, is able to distinguish the higher frequency components of a glass  
15 break event from other transient events which previously caused false alarms. The reference signal used in the cross-correlation is random and most other transient events produce signals having a high degree of periodicity in the higher frequency components. Positive cross-correlation  
20 provides a convenient approach for detecting a glass break event, particularly when used with other investigative techniques.

A reference glass break event signal, generally limited to the high frequency components, can be created by  
25 using known arrangements for selecting the frequencies followed by adjusting the amplitudes to fit the envelope of a glass break event (i.e. rapid increase followed by generally exponential decay). Any reference signal that has a high correlation with glass break events in general  
30 can be used. There may also be other reference signals which can distinguish glass break events from other transient events.

Wide-bandness and random have been used to describe the non-deterministic characteristic of a glass break  
35 event. The conventional sources of false alarms have a significant degree of periodicity (more predictable) and this property is used to distinguish these transient events

2117053

from a transient glass break event. Several different techniques can be used to improve the confidence in predicting whether a detected transient event is a glass break event. For example, a low assessment of periodicity together with a significant correlation to the reference glass break signal is more reliable than either measurement alone. Further reliability is possible by examining the envelope of the transient event signal for a sharp rise followed by a nonlinear decay similar to an exponential decay. Each of these measures are more effective when the low frequency components (preferably below about 1kHz) are removed as these components often are periodic in a glass break event and therefore mask the results to some extent.

Elimination of the low frequency components while maintaining a large higher frequency band maintains most of the information associated with the transient event and therefore is useful in distinguishing the likely source thereof. All of this useful information has been maintained, however, it is possible to analyse a reduced portion thereof if desired and sufficient reliability is achieved.

It should be noted that the time duration of analysis may be in the range of  $\frac{1}{4}$  to  $\frac{1}{2}$  seconds, and therefore, is not necessarily the entire glass shattering event with secondary shattering, such as the glass shattering again on impact with the floor.

As illustrated by the integration plots, glass break events generally possess a higher degree of overall correlation to the glass break pattern (i.e. Figure 2A) than do non-glass break events.

The amplitude dependency of the function is evident in the output from the 4kHz tone signal (Figure 13). The tone signal amplitude is significantly greater than the average amplitude of the pattern, therefore, the 4kHz components within the pattern are amplified, producing a degree of positive correlation which is higher than that given when the pattern is mixed with itself. This

2117053

situation illustrates the need for other post processing mechanisms which are less amplitude dependent than direct integration of the cross-correlation output. In terms of providing a first order evaluation of the degree of correlation, the integration algorithm is found to be adequate, but is supplemented by analysis from the autocorrelation output.

It has been found that the non-deterministic nature of the glass break event allows it to be statistically distinguished from other non-glass break event signals and thus, provides a reliable apparatus and method for distinguishing glass break events. The particular statistical techniques disclosed are only representative of techniques which can identify this non-deterministic nature of the glass break event and the invention is not limited to these particular techniques, although they are readily available and thus, suitable for this approach.

Simplifications of these techniques can be used to allow for a low cost detector. Thus, the invention realizes that there are certain low frequency components of a glass break event that should be removed to allow improved statistical analysis of higher frequency components, which due to their non-deterministic nature, can be distinguished from other non-glass break event sources.

One useful measure of the degree of wide-bandness in the output signal is made by using the Degree of Correlation information to determine Maximum Peak Value (Average of the Absolute Value of all Peak Values). With noise, the ratio is very high (approximately 1000 or more), whereas periodic signals have a low ratio (approximately 1). A glass shattering signal has an intermediate ratio (approximately 10). This ratio provides a convenient, inexpensive assessment of the degree of correlation. Another measure of the information contained in the degree of correlation in autocorrelation, is the time to the first zero crossing of the signal. Note how a thunderstorm signal (powerful low frequency) has a long duration to the

2117053

zero crossing, whereas with a glass shattering event, the duration is short. Autocorrelation provides assessment of the number of frequencies in the signal (i.e. whether the signal is wide-band).

5           The above measures illustrate how it is possible to extract useful information from autocorrelation output and are not the only possible measures.

10           Although various preferred embodiments of the present invention have been described herein in detail, it will be appreciated by those skilled in the art, that variations may be made thereto without departing from the spirit of the invention or the scope of the appended claims.

THE EMBODIMENTS OF THE INVENTION IN WHICH AN EXCLUSIVE PROPERTY OR PRIVILEGE IS CLAIMED ARE DEFINED AS FOLLOWS:

1. A glass break detector for detecting the breaking of glass comprising an acoustic transducer which is capable of producing a wide band electrical signal, a processing arrangement for processing sudden changes in the electrical signal caused by a transient event, said processing arrangement filtering the output signal through a high pass filter and analysing the filtered signal for a transient event which is non-deterministic in nature, and means for producing an alarm signal when a transient non-deterministic event is detected.
2. A glass break detector as claimed in claim 1 wherein said high pass filter eliminates frequencies below about 1kHz.
3. A glass break detector as claimed in claim 1 wherein said processing means uses a statistical technique for determining whether the signal is non-deterministic.
4. A glass break detector as claimed in claim 3 wherein said processing means uses autocorrelation to determine the amount of periodicity of the filtered signal and determining the filtered signal is non-deterministic when no significant periodicity is found.
5. A glass break detector as claimed in claim 4 wherein said processing means further includes means for comparing the filtered signal with a reference signal representative of high frequency components of a glass break signal, said means for comparing using a cross-correlation technique to evaluate, in combination with results of the autocorrelation, whether the filtered signal indicates a glass break event has occurred.

WH-8941CA

6. A glass break detector as claimed in claim 5 wherein said high pass filter eliminates frequencies below 1 kHz.

7. A glass break detector comprising a transducer for sensing acoustic pressure and a processing arrangement which processes an output signal of said transducer using statistical techniques to identify a signal which is non-deterministic and of a type representative of a glass break event and wherein said statistical techniques assess the amount of periodicity in the signal and the amount of correlation of the output signal with a predetermined reference event signal typical of a glass break event and producing an alarm signal when there is a transient event which causes a change in the output signal assessed to have

- 1) no significant periodicity, and
- 2) a significant correlation with the reference glass break signal.

8. A glass break detector as claimed in claim 7 wherein the transducer is a microphone and the output signal of the microphone is passed through a high pass filter which removes low frequency components.

9. A glass break detector as claimed in claim 8 wherein frequencies less than about 1kHz do not pass through the high pass filter.

10. A glass break detector as claimed in claim 9 wherein an approximate autocorrelation technique is used to determine the extent of periodicity in the signal.

WH-8941CA

11. A glass break detector as claimed in claim 7 wherein said processing arrangement uses an autocorrelation technique and a cross-correlation technique to determine the extent of periodicity and correlation of the signal.

12. A method of detecting the breaking of glass comprising sensing acoustical pressure and producing an

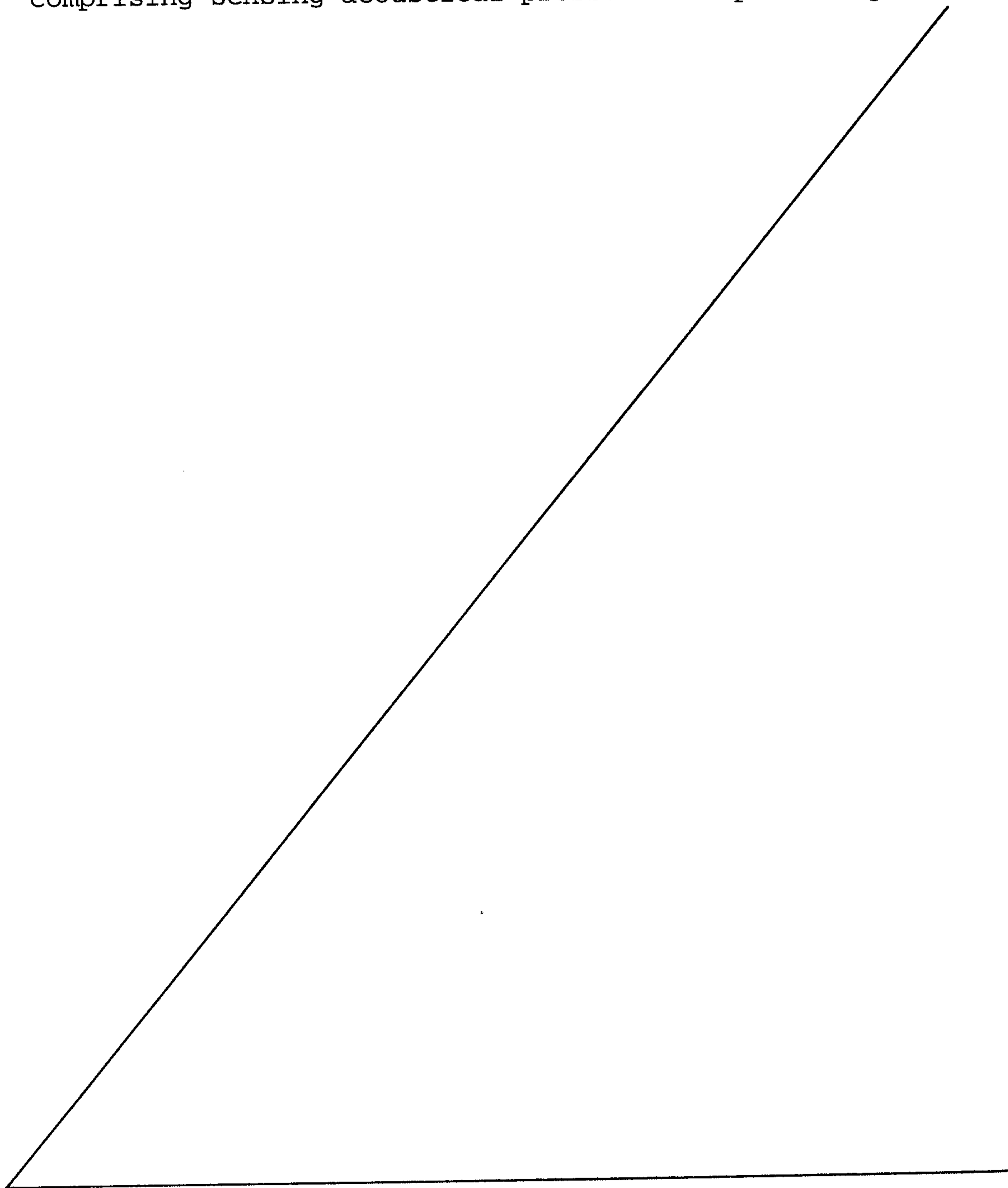

2117053

electrical signal representative of the sensed acoustical pressure, and identifying changes in the signal caused by transient events and using statistical techniques for assessing the periodicity of the changes in the signal and discriminating the changes in the signal from background noise and producing an alarm signal when there is no significant periodicity in the portion of the signal containing the changes and the signal is of an intensity greater than background noise and distinguishable therefrom.

13. A method of detecting the breaking of glass as claimed in claim 12 including initially passing the electrical signal through a high pass filter which filters out frequencies low frequency components of a glass break signal which commonly has significant periodicity.

14. A method of detecting the breaking of glass as claimed in claim 13 wherein the statistical techniques include cross correlating the electrical signal with a predetermined reference glass break signal.

15. A method of detecting the breaking of glass as claimed in claim 14 including using autocorrelation techniques for determining whether the electrical signal is wide-band.

16. A method of detecting the breaking of glass as claimed in claim 15 including using a sample period for assessing the electrical signal less than the sample period necessary for an entire glass break event.

17. A method of detecting the breaking of glass as claimed in claim 12 including filtering the electrical signal to eliminate the effect of the low frequency "thud" associated with a glass break event.

## 2117053

18. A method of detecting the breaking of glass as claimed in claim 13 wherein said reference glass break signal has been processed to remove frequencies below 1kHz.

19. A glass break detector for detecting the shattering of glass comprising an acoustic transducer which produces an electrical signal of the glass break event including initial low frequency components associated with a force leading to the flexure and subsequent shattering of the glass and high frequency components associated with the shattering of the glass which are wide-band with no significant periodicity and processing means for processing the electrical signal to remove low frequency components and analysing the remaining high frequency components of the signal for no significant periodicity and characteristics indicative of a glass shattering event and based thereon determining the occurrence of a glass break event.

20. A glass break detector for detecting the shattering of glass as claimed in claim 19 including statistical means for analysing the high frequency components of the electrical signal for no significant periodicity and for a wide-band signal.

21. A glass break detector for detecting the shattering of glass as claimed in claim 20 wherein said statistical means includes an autocorrelation technique for assessing wide-bandness of the electrical signal.

22. A glass break detector for detecting the shattering of glass as claimed in claim 20 wherein said statistical means uses a cross-correlation technique of the filtered signal relative a reference glass shattering signal for distinguishing a glass breakage event.

WH-8941CA

23. A glass break detector comprising a microphone which produces an electrical signal and a processing arrangement which filters the signal to having a wide-band frequency range to include the remove low frequency components, said processing means analysing the filtered signal for recognition of a non-deterministic signal having a significant correlation relative to a reference glass break signal and producing an alarm when such a signal is recognized.

24. A glass break detector as claimed in claim 23 wherein said processing means samples the filtered signal and uses statistical techniques for analysing the signal and determining whether a glass break event has occurred.

25. A glass break detector as claimed in claim 23 wherein said statistical techniques are autocorrelation and cross-correlation techniques.

26. A glass break detector for detecting the breaking of glass comprising an acoustic transducer which produces a wide band electrical signal in response to receipt of sound energy of a glass break event, a processing arrangement for analyzing the electrical signal of the acoustic transducer for possible detection of glass break events, said processing arrangement including means for detecting a sudden high amplitude transient event that could be caused by the initial portion of a glass break event, waiting a short period of time after detection of a sudden high amplitude transient event and thereafter sampling the signal over a further period of time which would include the high frequency glass shattering portion of a glass break event, said signal being sampled by dividing the signal into many short segments and analyzing each short segment for an assessment of the degree of

WH-8941CA

randomness in the short segment, using the assessment of the short segments to distinguish periodic signals from glass break signals and upon recognition of a glass break signal producing an alarm signal.

27. A glass break detector as claimed in claim 26 wherein said processing arrangement includes a microprocessor which converts the electrical signal into bits during sampling and for each sample compares each bit to the following bit and records any change in the bit value as an assessment of the degree of change and accumulates the number of changes for each sample period.

28. A glass break detector as claimed in claim 27 wherein said microprocessor uses an exclusive or function for evaluating changes between bits of a sample period.

29. A glass break detector as claimed in claim 28 wherein said microprocessor analyses the results of the samples with respect to distribution of the results and based on the characteristics of the distribution makes a prediction if a glass break event has been detected.

30. A glass break detector as claimed in claim 29 wherein the characteristics of the distribution include determination whether the modal value falls within a given range, an assessment of the range of the distribution and an assessment of the modal area.

31. A glass break detector as claimed in claim 27 wherein the signal from the acoustic transducer is converted to an 8 bit digital signal.

WH-8941CA

32. A glass break detector comprising means for detecting a sudden transient event which could be a glass break event,

means for sampling the signal after a specified delay to form successive experiment segments where each experiment segment is of sufficient time duration to include the random nature of a glass break signal when a sudden transient event has been detected,

means for evaluating the experiment segments using statistical techniques for characteristics which distinguish periodic signal sources from glass break event signals which are not periodic,

and means for producing an alarm when said means for evaluating indicates the signal is not periodic.

33. A glass break detector as claimed in claim 32 wherein said specified delay is sufficient to allow bodies which have been struck thus producing a sudden transient signal to resonate.

34. A glass break detector as claimed in claim 32 wherein said statistical techniques include comparison of past values of the signal to future values of the signal.

35. A glass break detector as claimed in claim 34 wherein said statistical techniques include autocorrelation.

36. A glass break detector as claimed in claim 35 wherein autocorrelation is carried out on each experiment segment whereafter the distribution of the auto correlation results are compared.

WH-8941CA

37. A glass break detector as claimed in claim 34 wherein said initial delay is in the order of 50 milliseconds and each experiment segment is of a duration of at least 2.5 milliseconds.

38. A glass break detector as claimed in claim 37 wherein about 30 experiment segments are analysed.

39. A method of detecting the breaking of glass comprising using a microphone to detect sound in an area to be monitored, using an analog to digital converter to convert the signal from the microphone to a series of bits, analysing the series of bits over time to determine a measure of change in amplitude occurring in the signal in a first experiment, repeating the experiment many times, determining the distribution of changes in amplitude of the experiments and determining if the distribution is indicative of a possible glass break event by using the distribution to determine other statistical factors which assist in improving the prediction of whether a glass break event has occurred.

40. A method as claimed in claim 39 wherein said statistical factors include determining the mode, range and mean of the distribution.

41. A method as claimed in claim 39 including using an initial detection means for recognizing a signal portion similar to the initial thud of a glass break event and upon recognition thereof sending the signal to said analog to digital converter.

WH-8941CA

42. A method as claimed in claim 41 including delaying analysis of said signal for a short period upon detection of a signal portion similar to an initial thud of a glass break event.

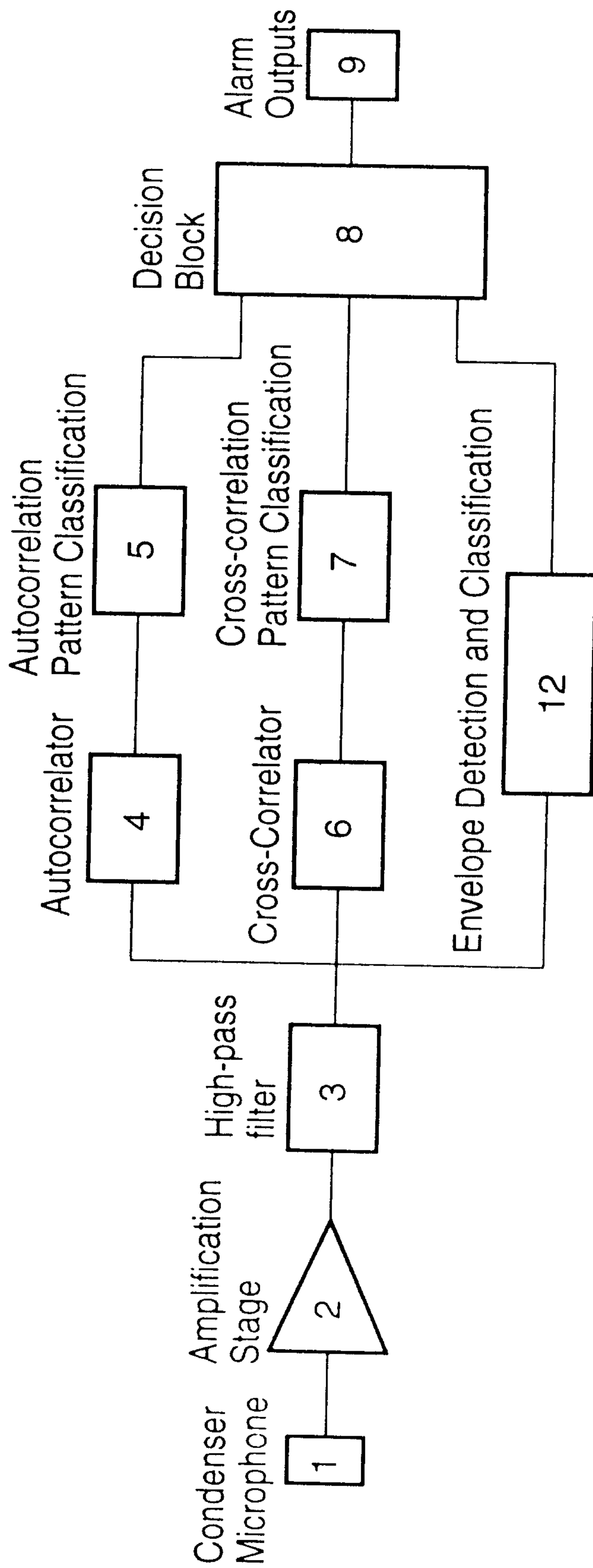

FIG.1.

2117053

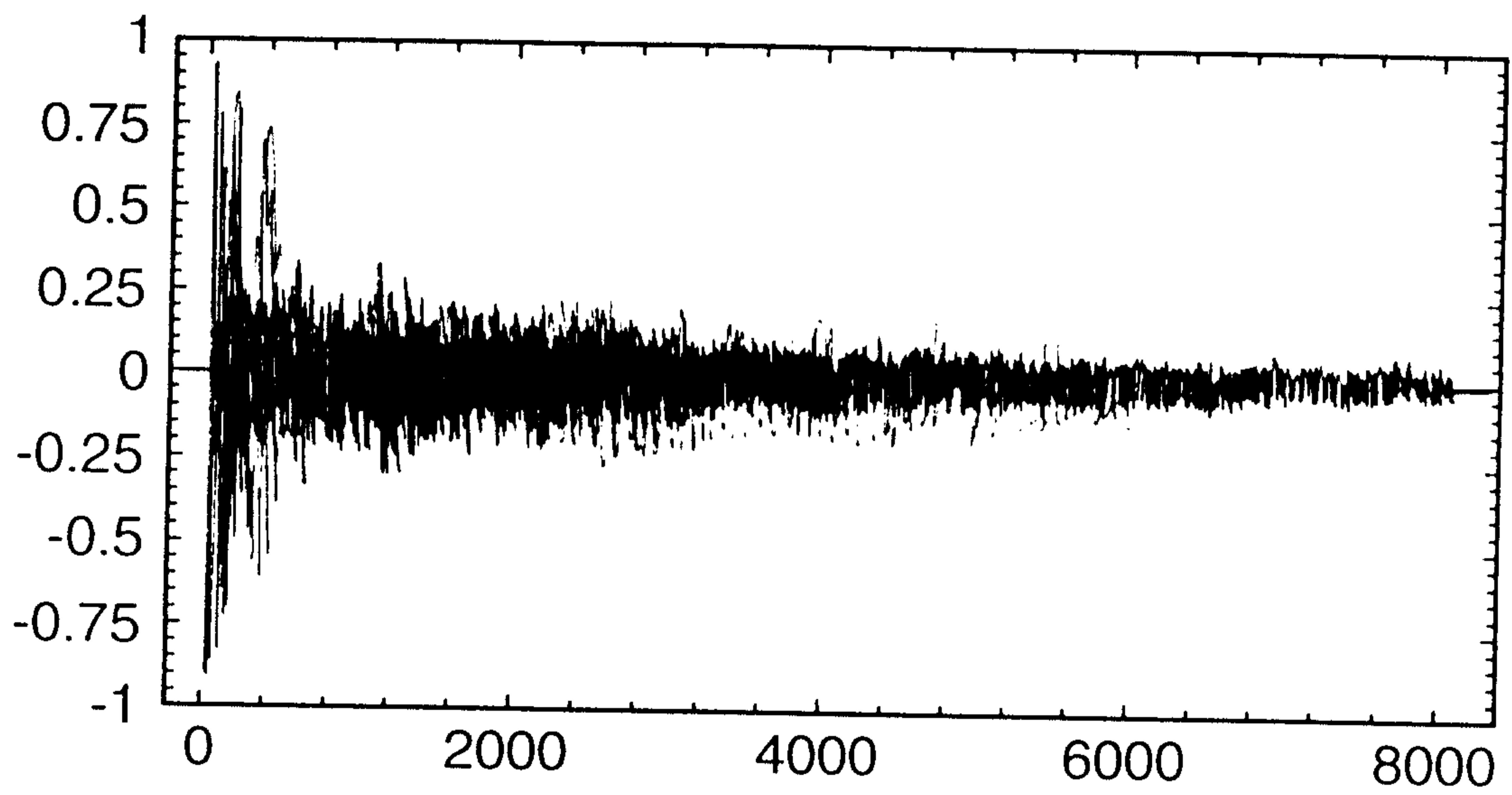

FIG.2 A.

2117053

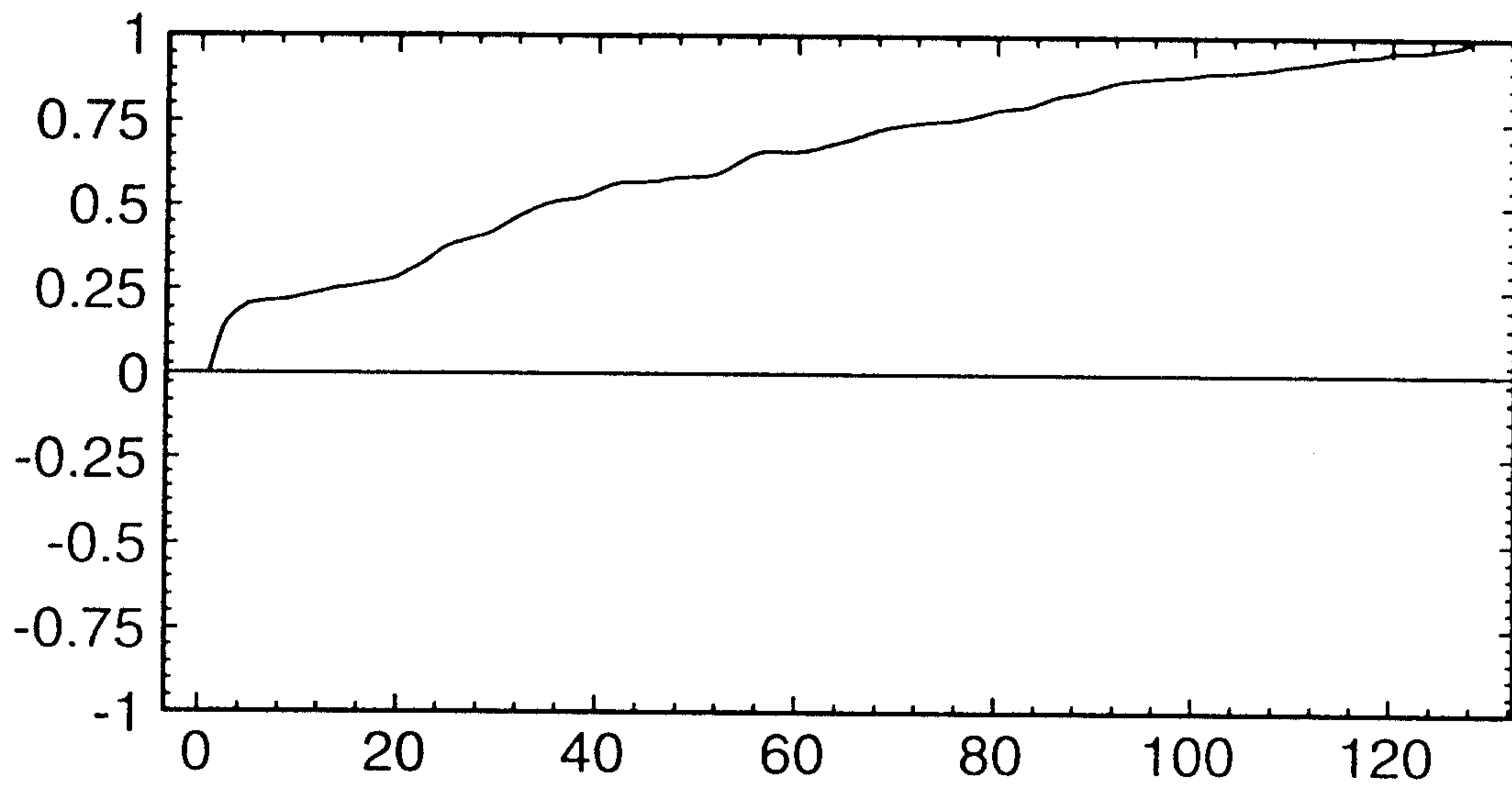

FIG.2B.

21 170 53

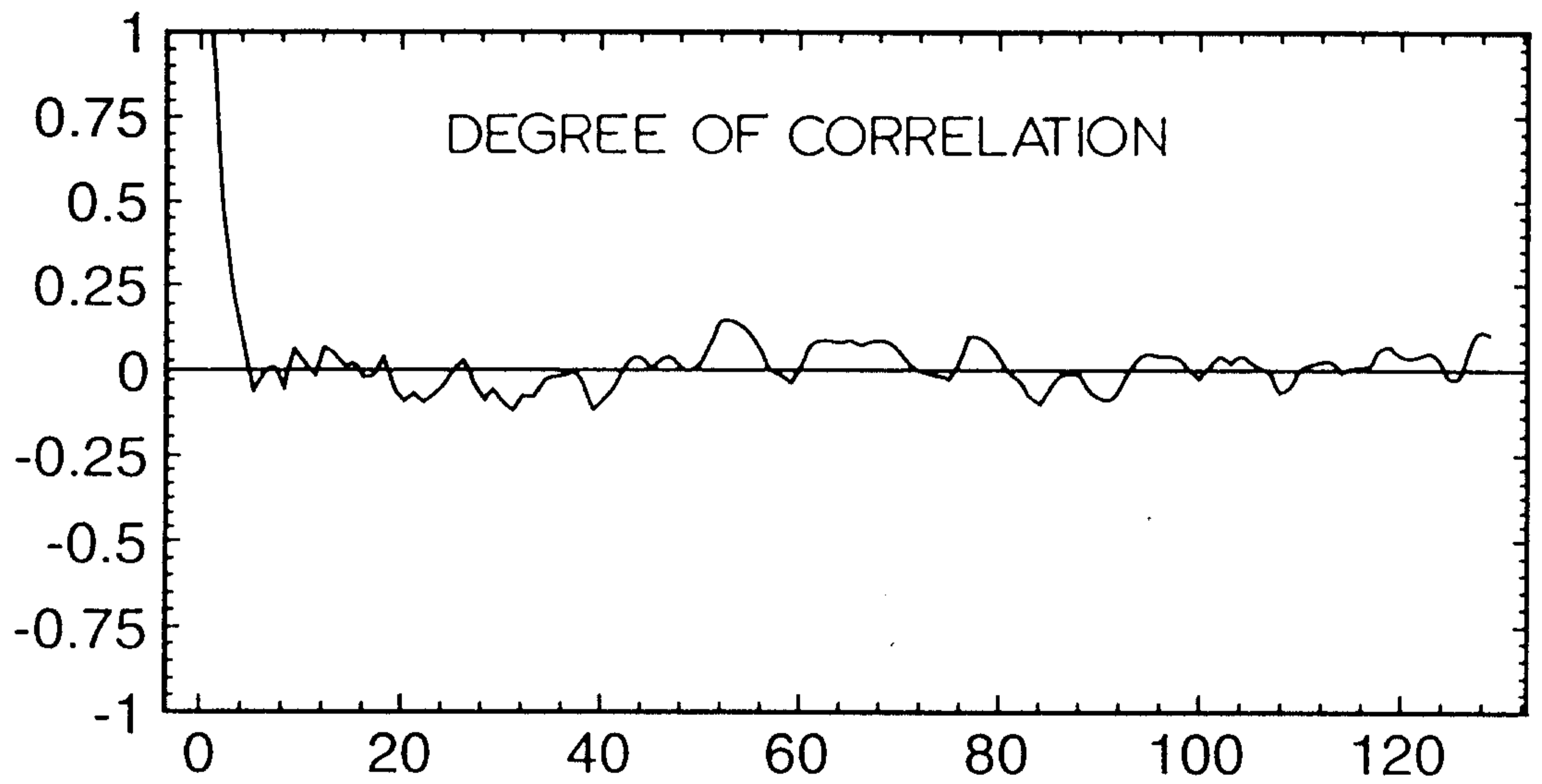
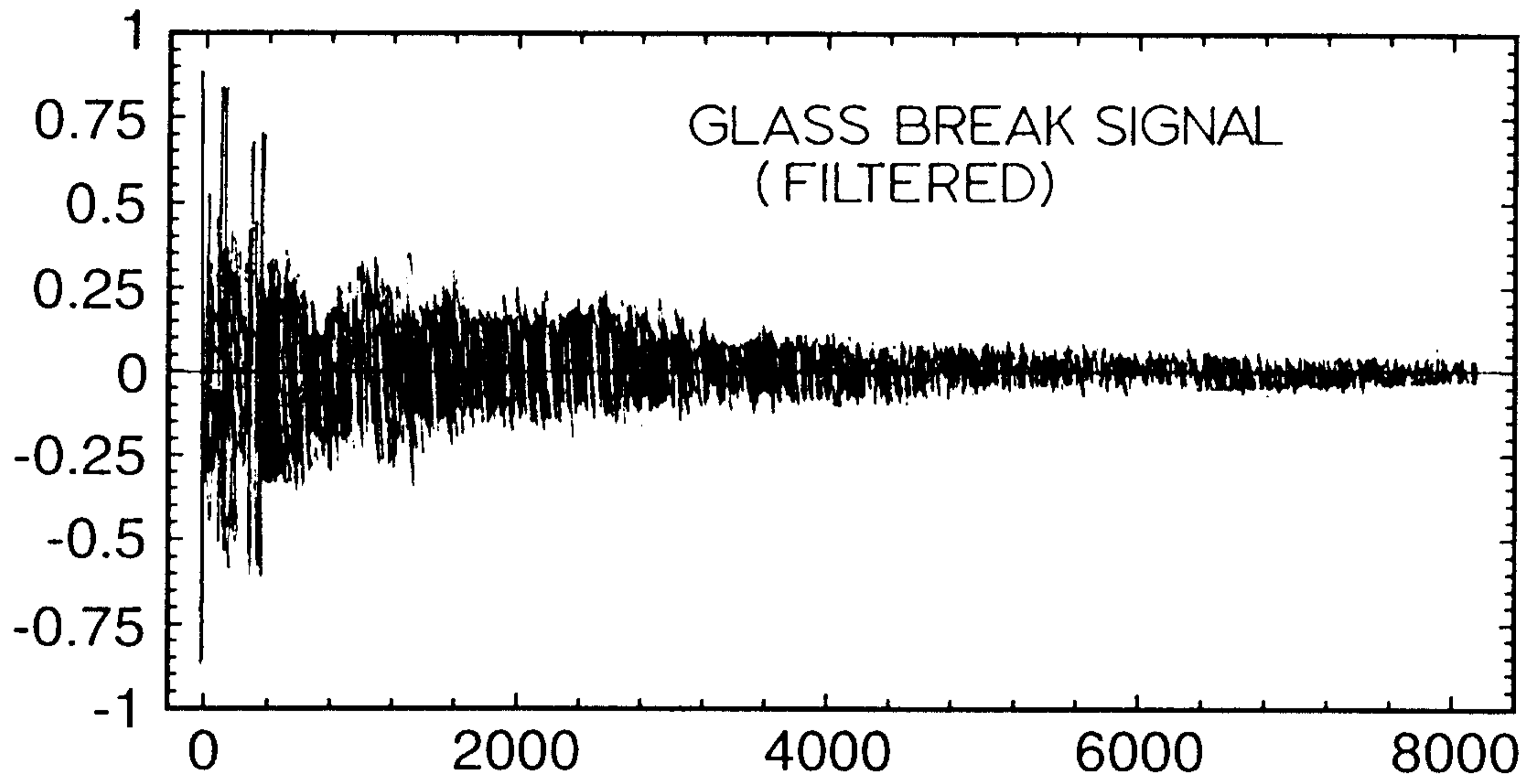

FIG.3.

2117053

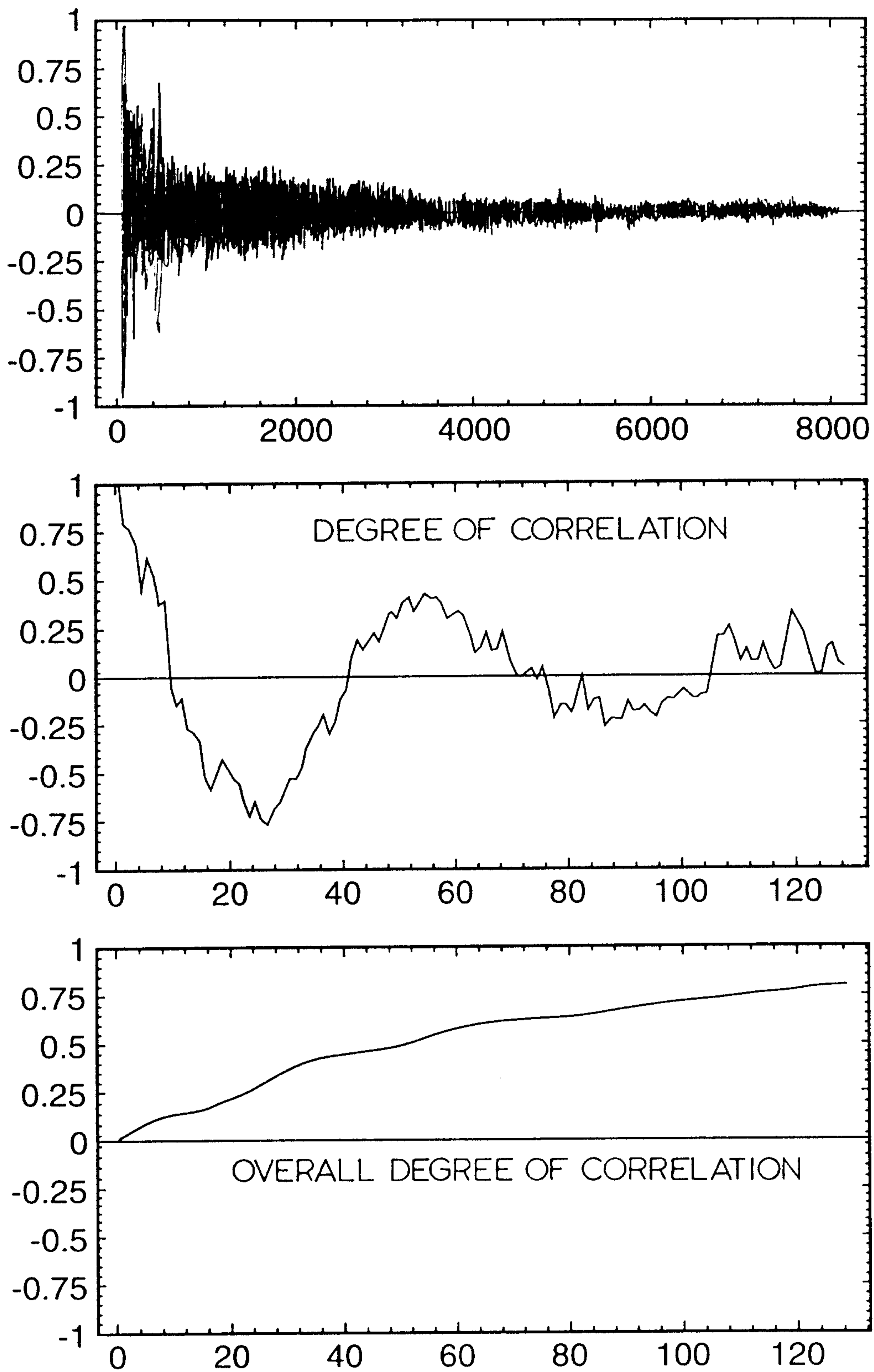

FIG.4.

2117053

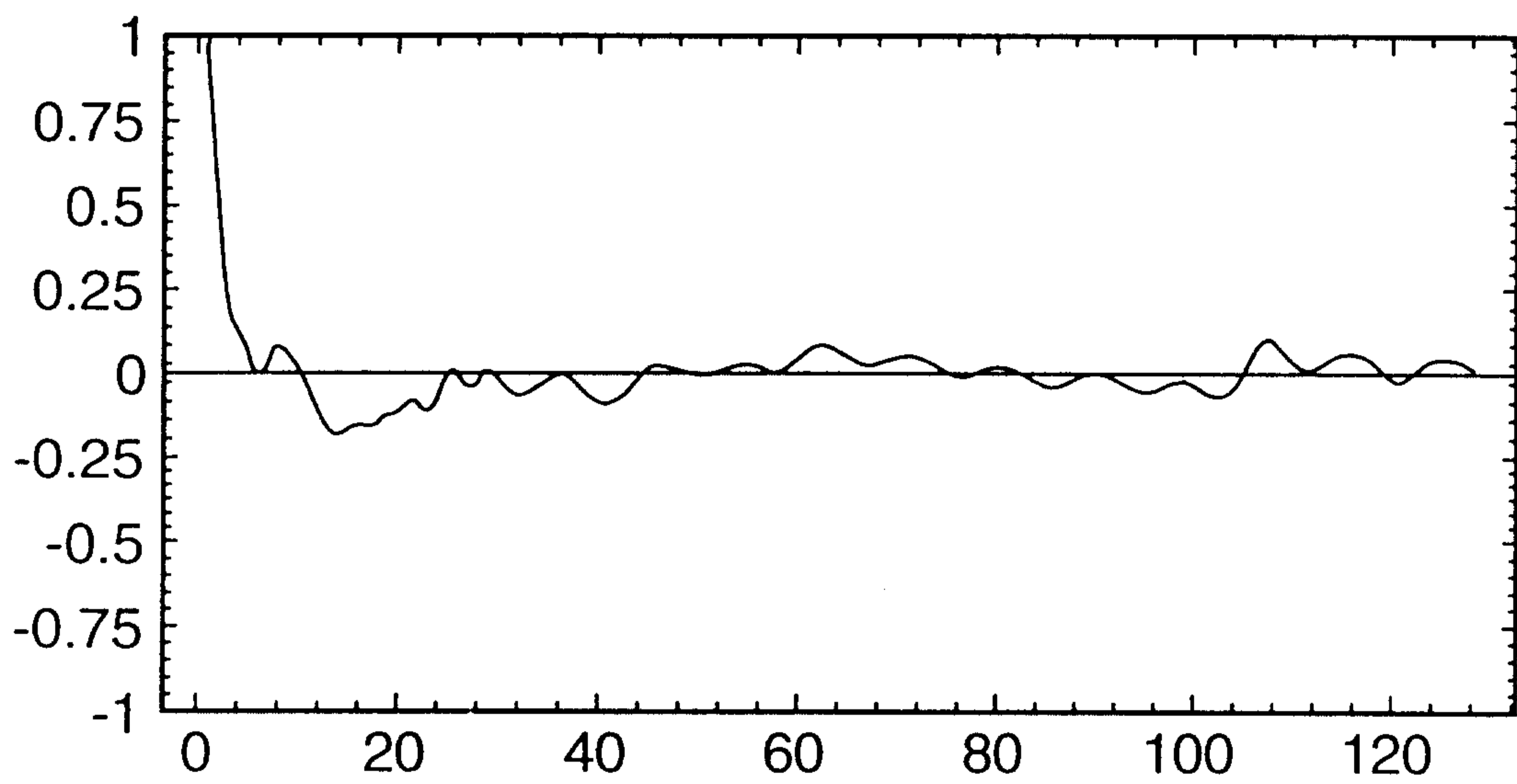
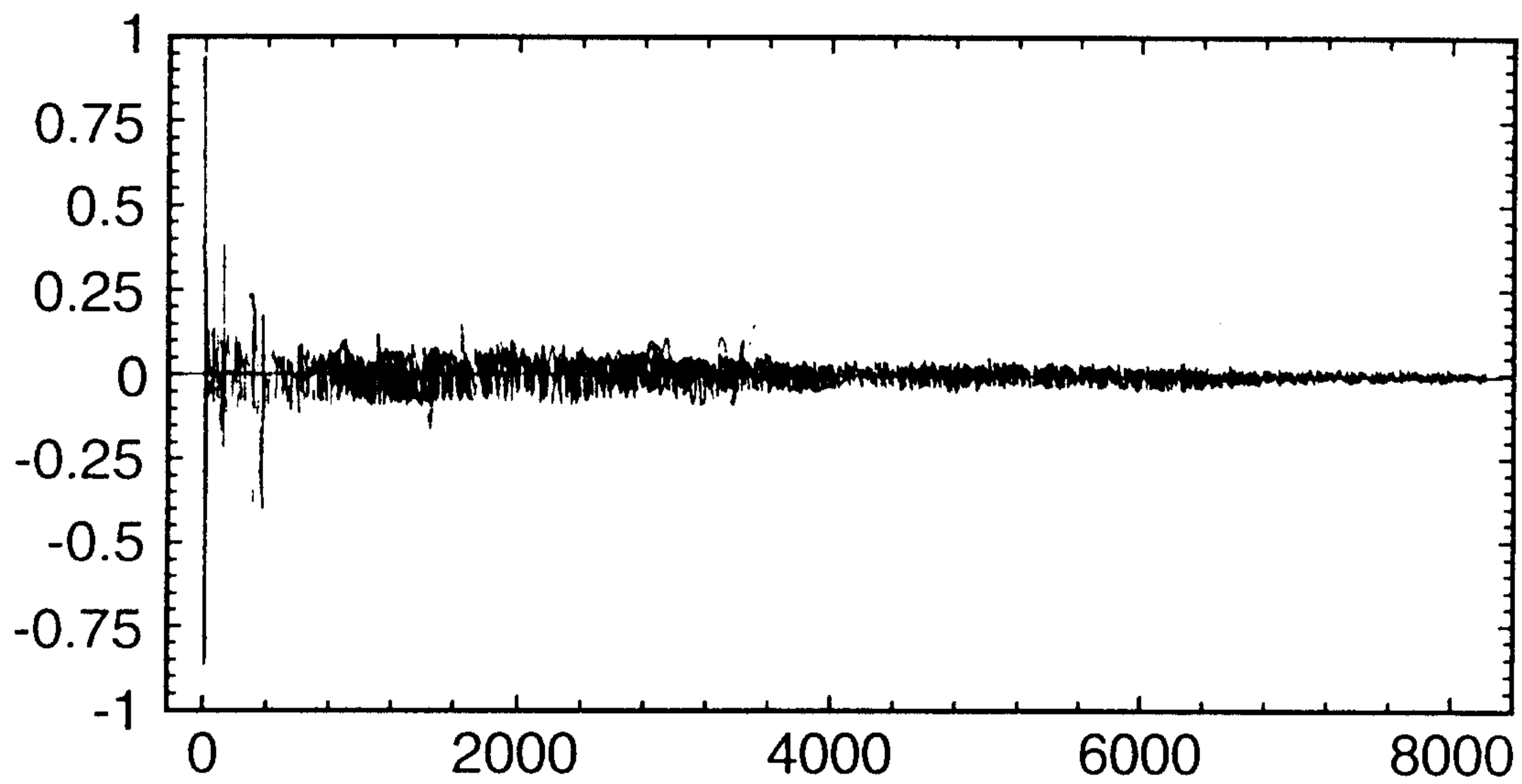

FIG.5.

2117053

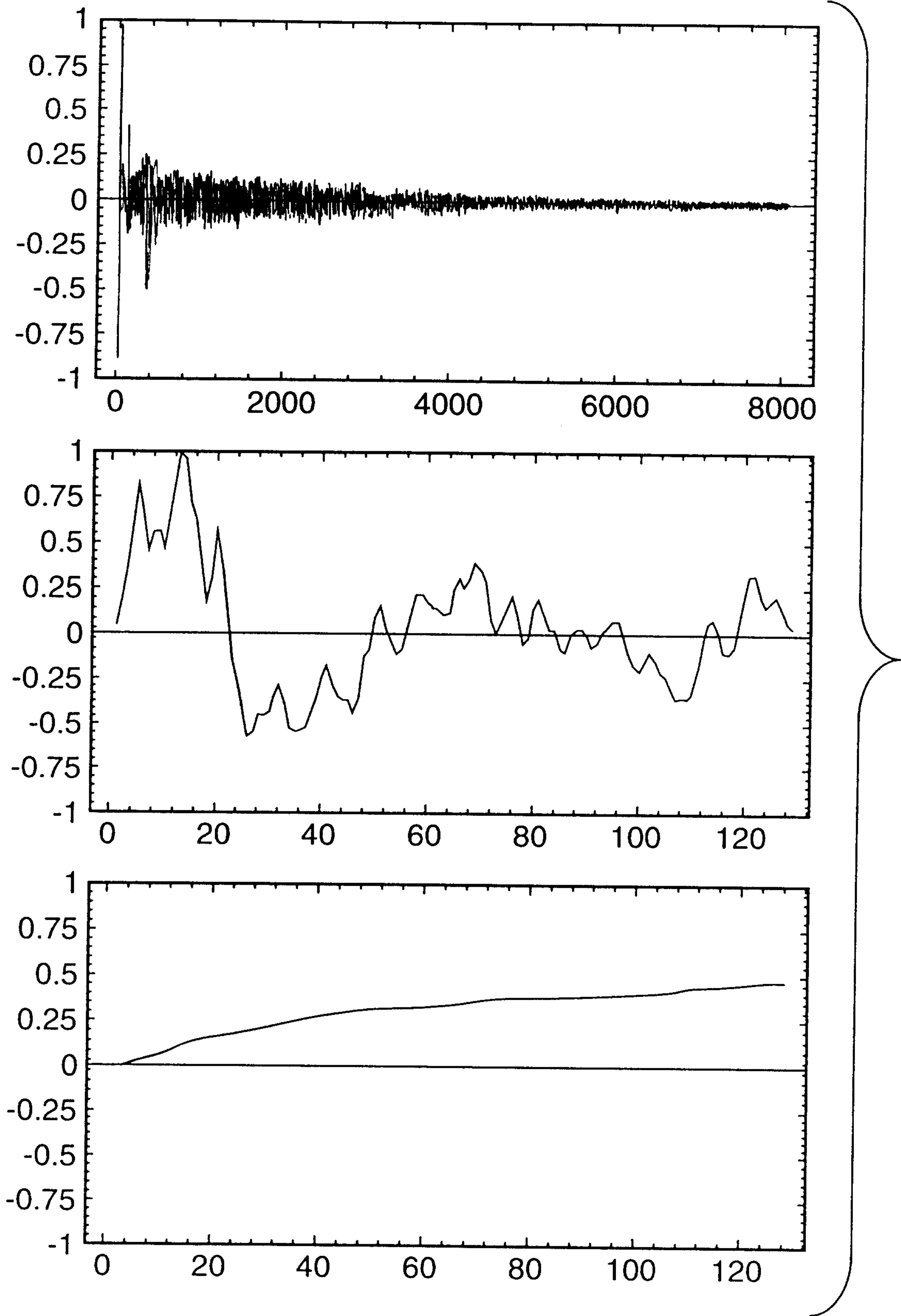

FIG.6.

2117053

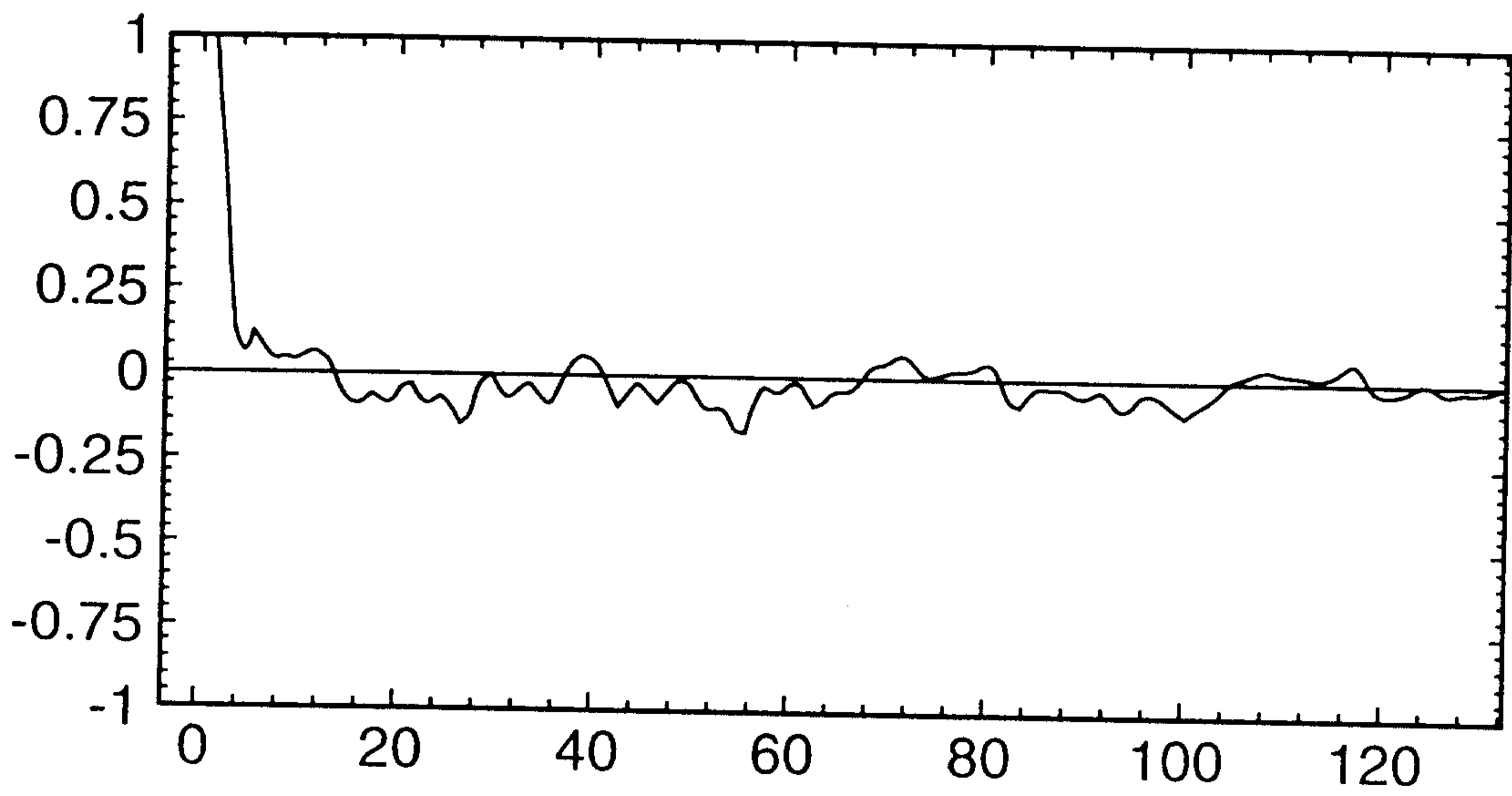
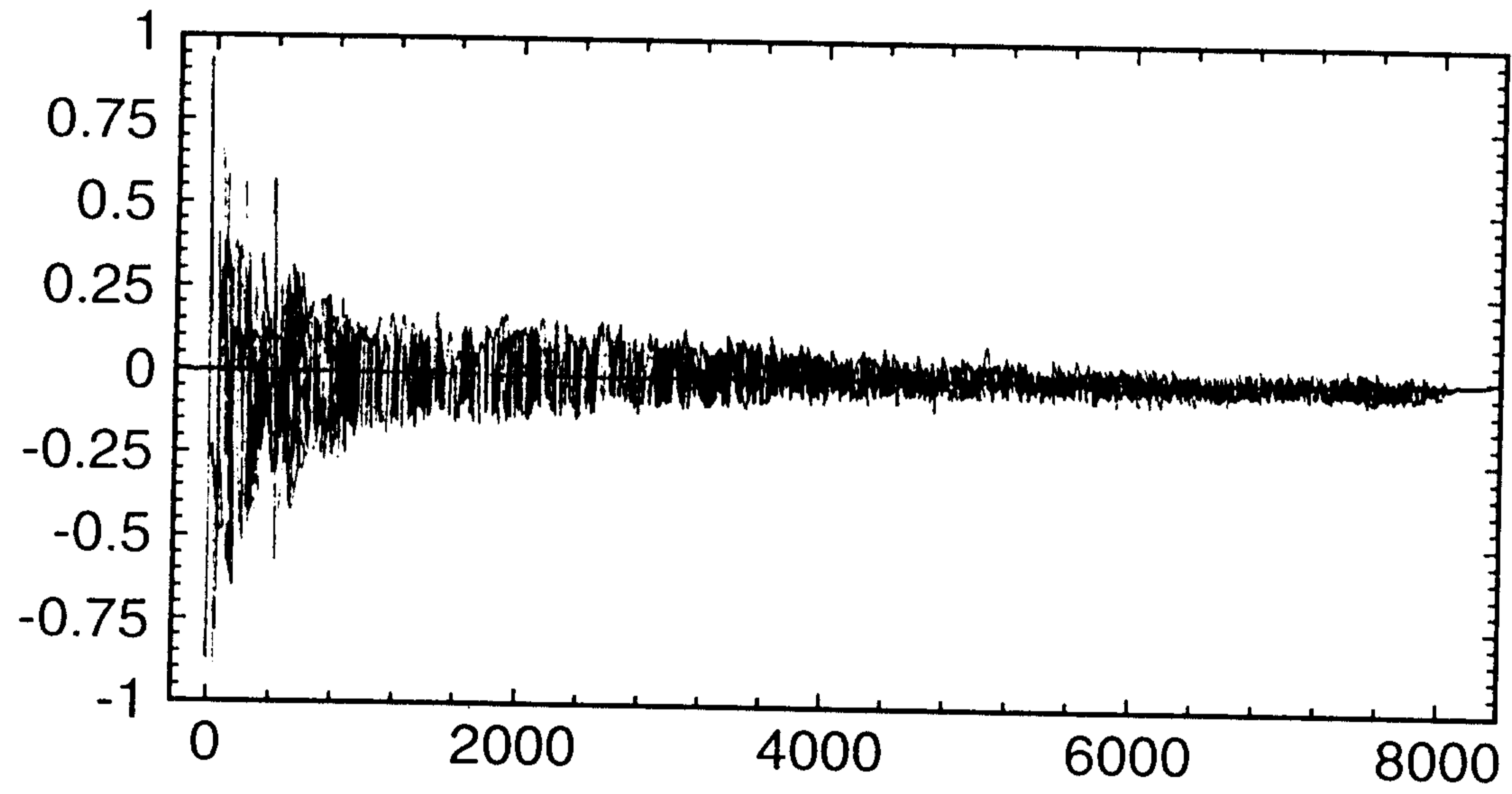

FIG.7.

2117053

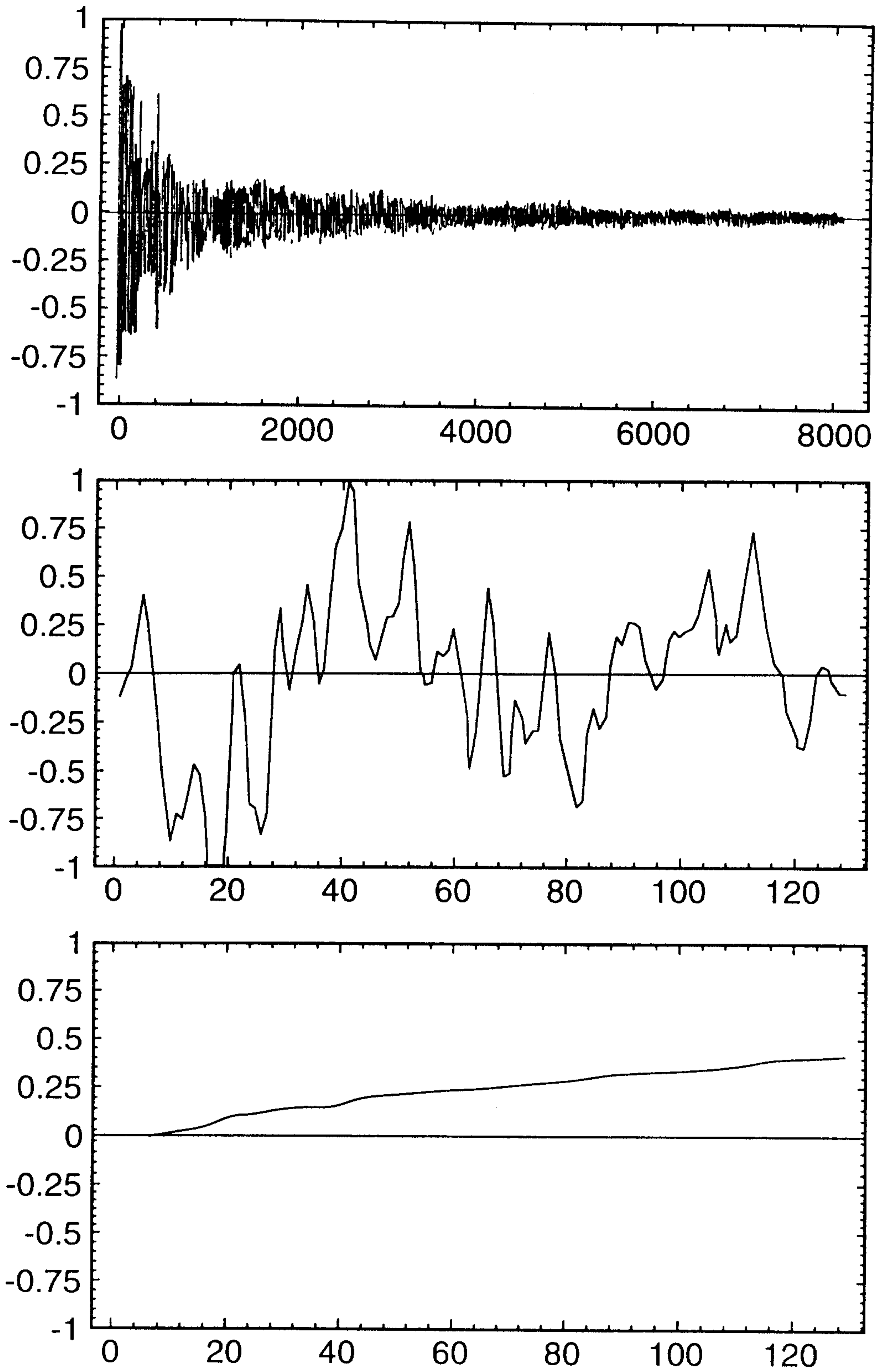

FIG.8.

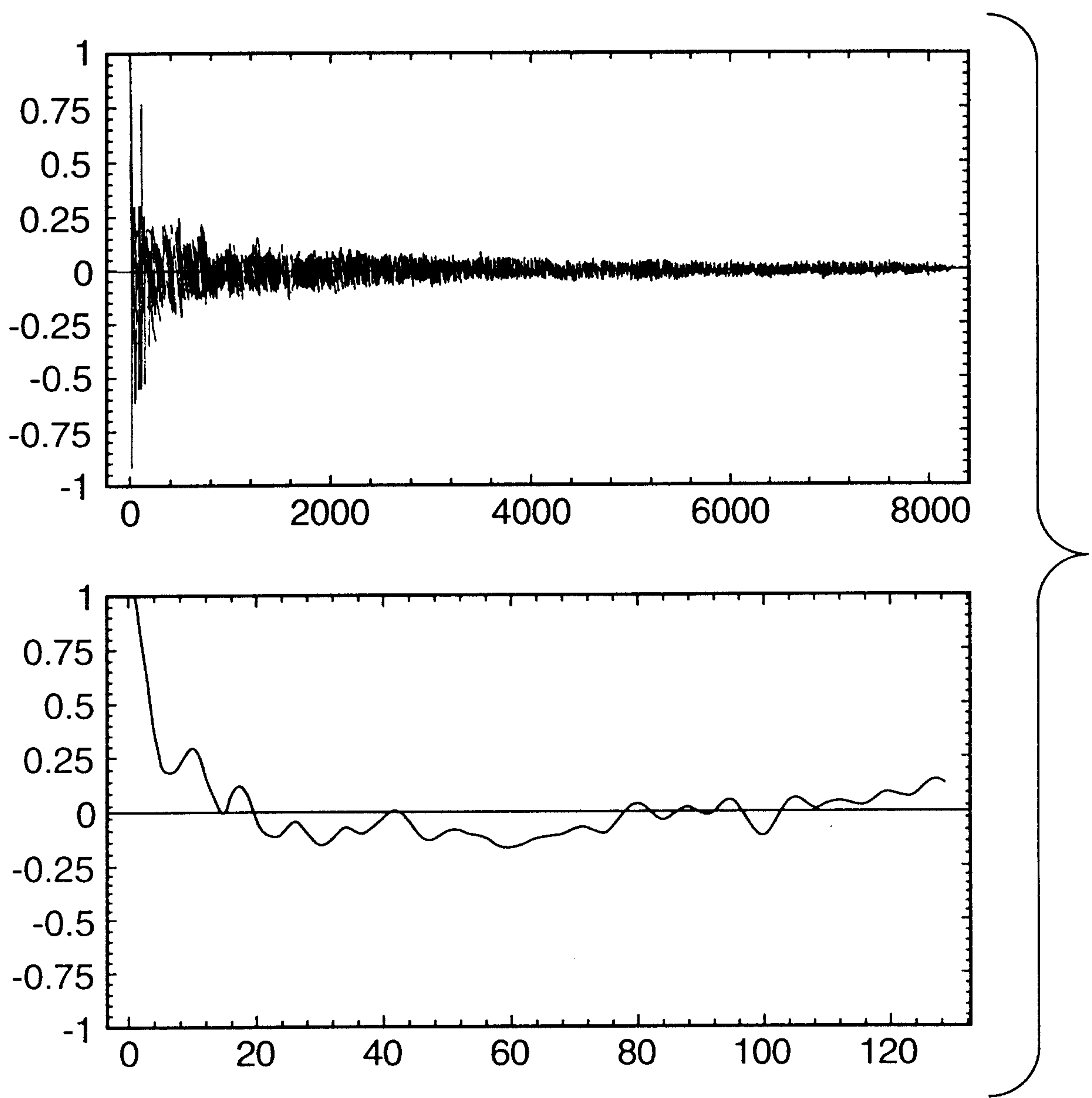

FIG.9.

2117053

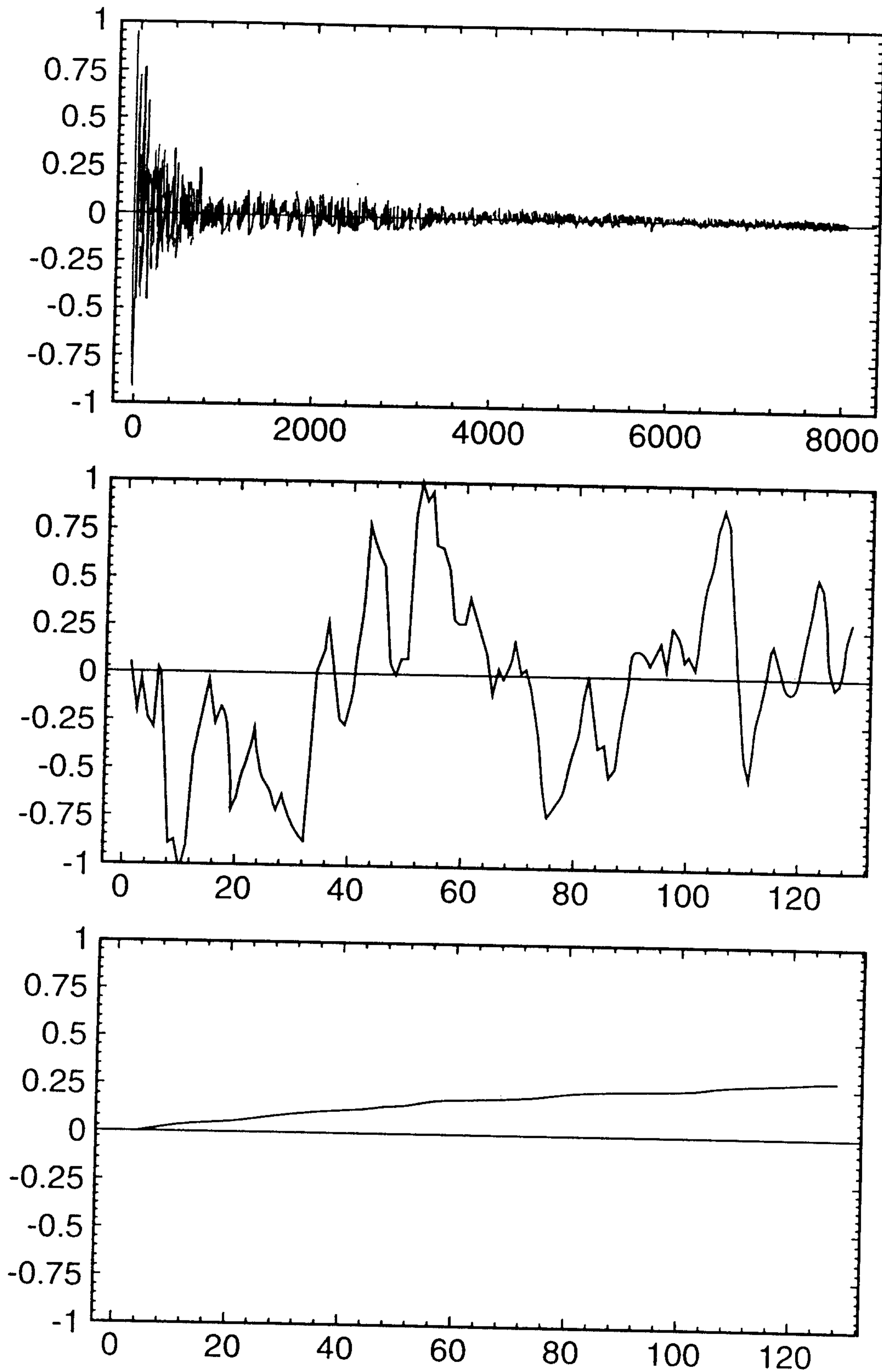

FIG.10.

2117053

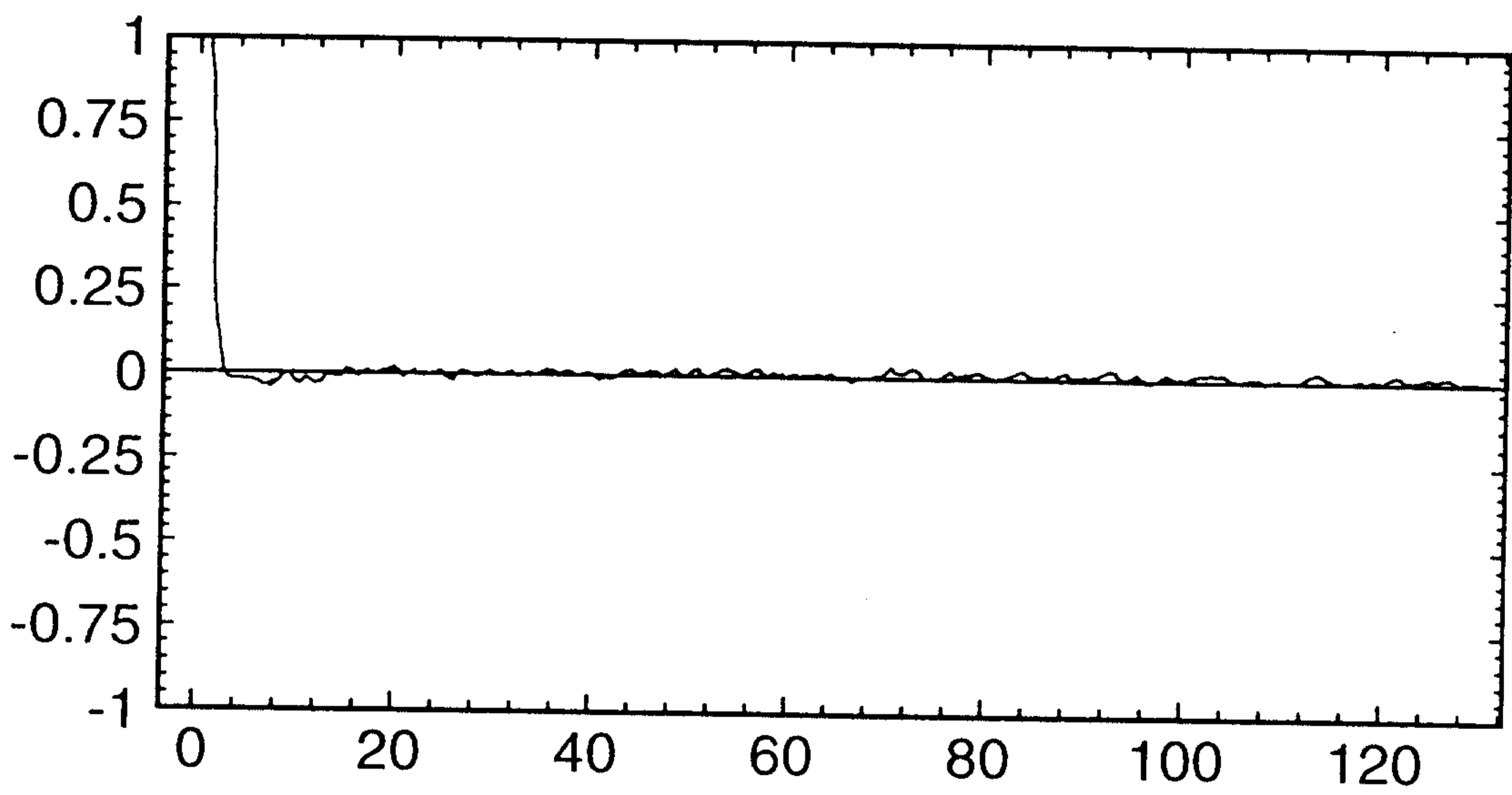
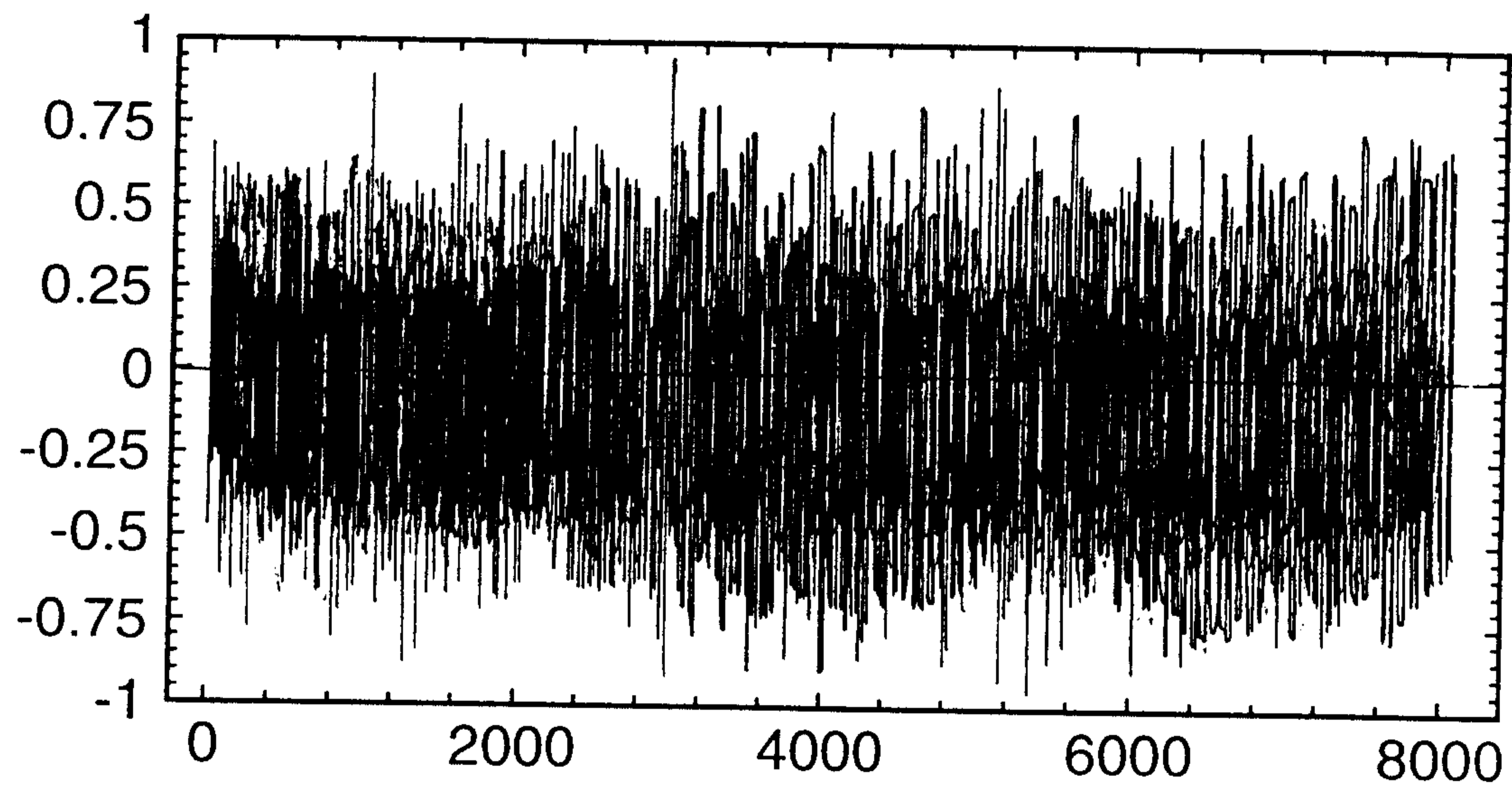

FIG.11.

A

2117053

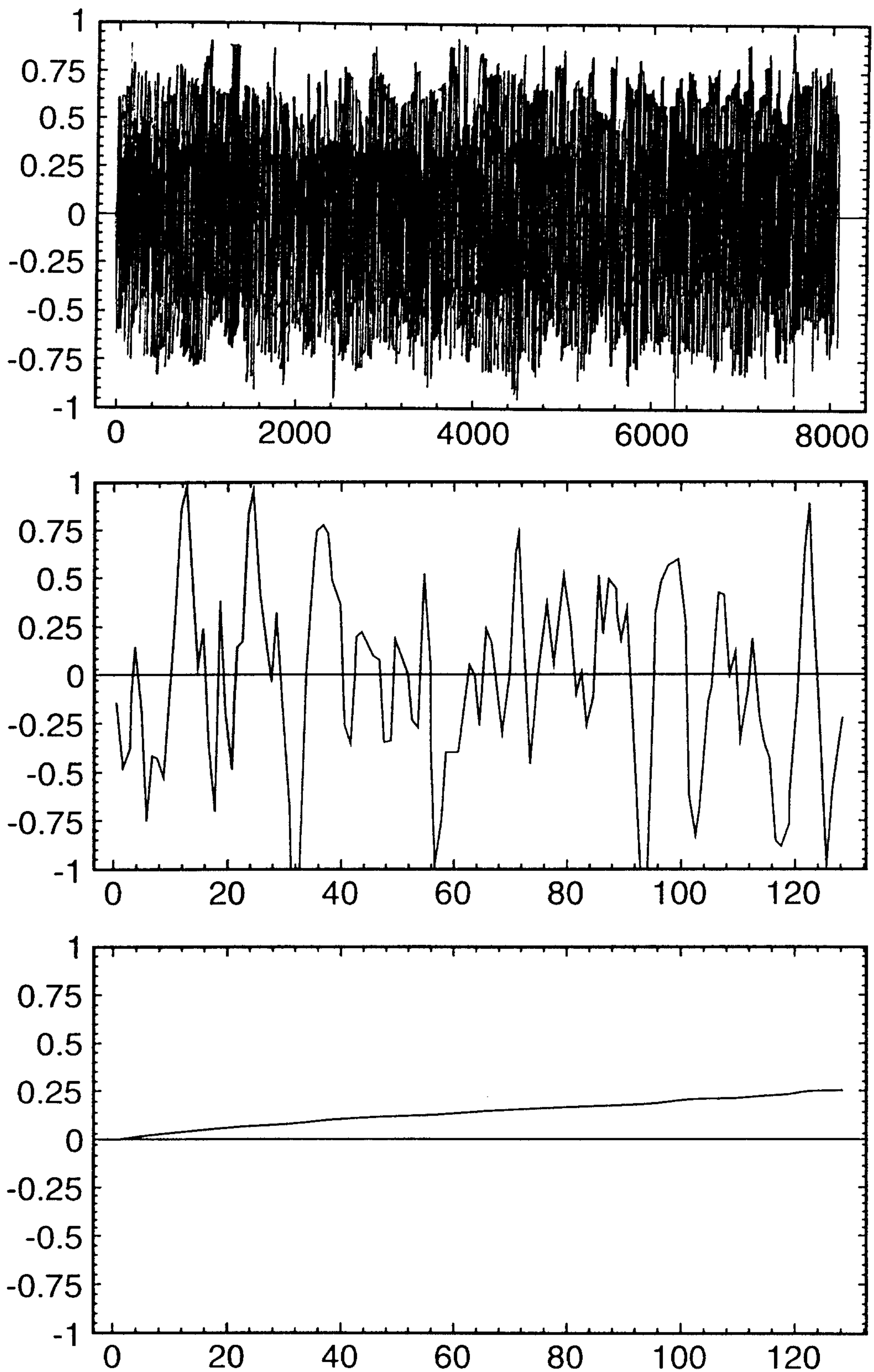

FIG.12.

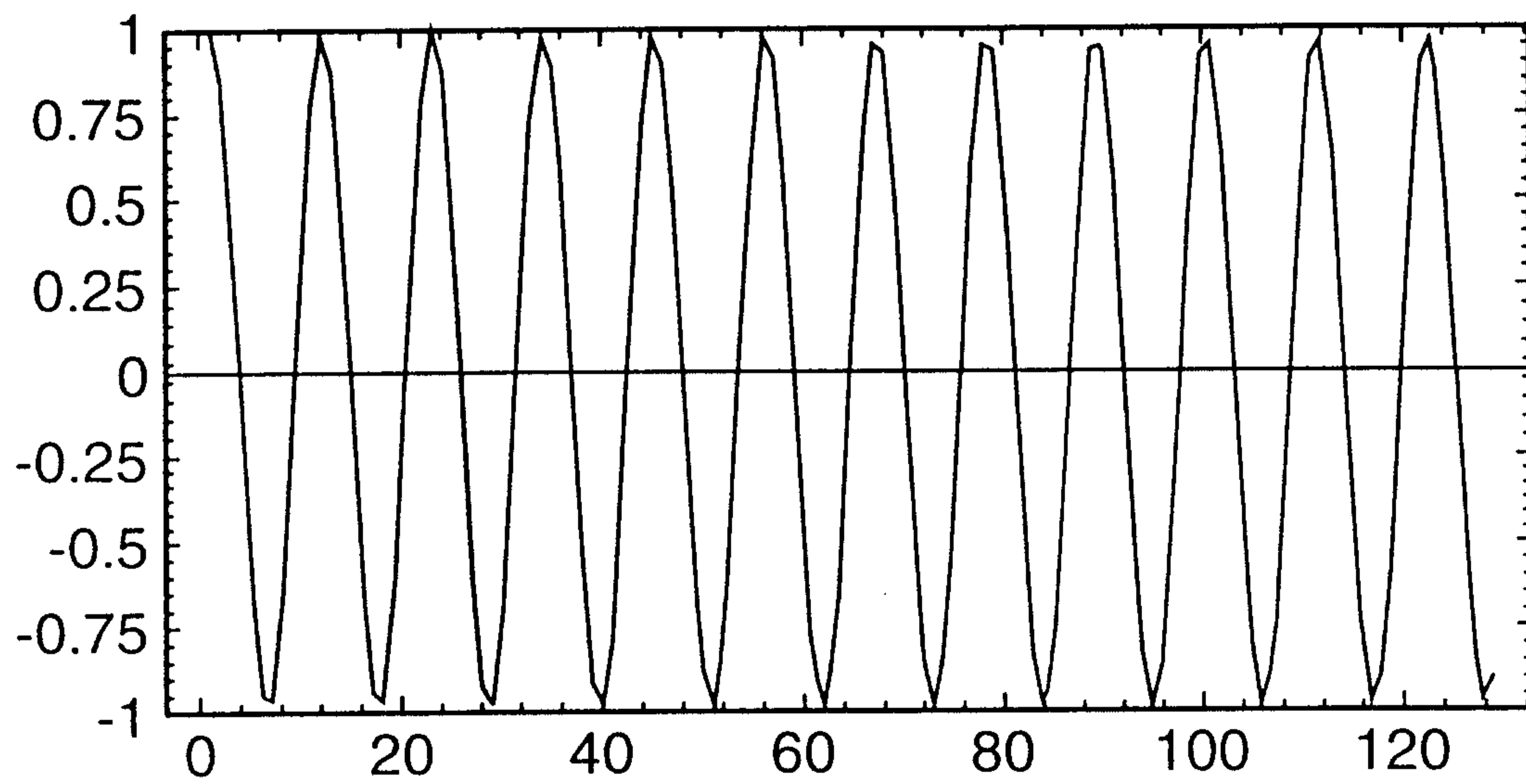
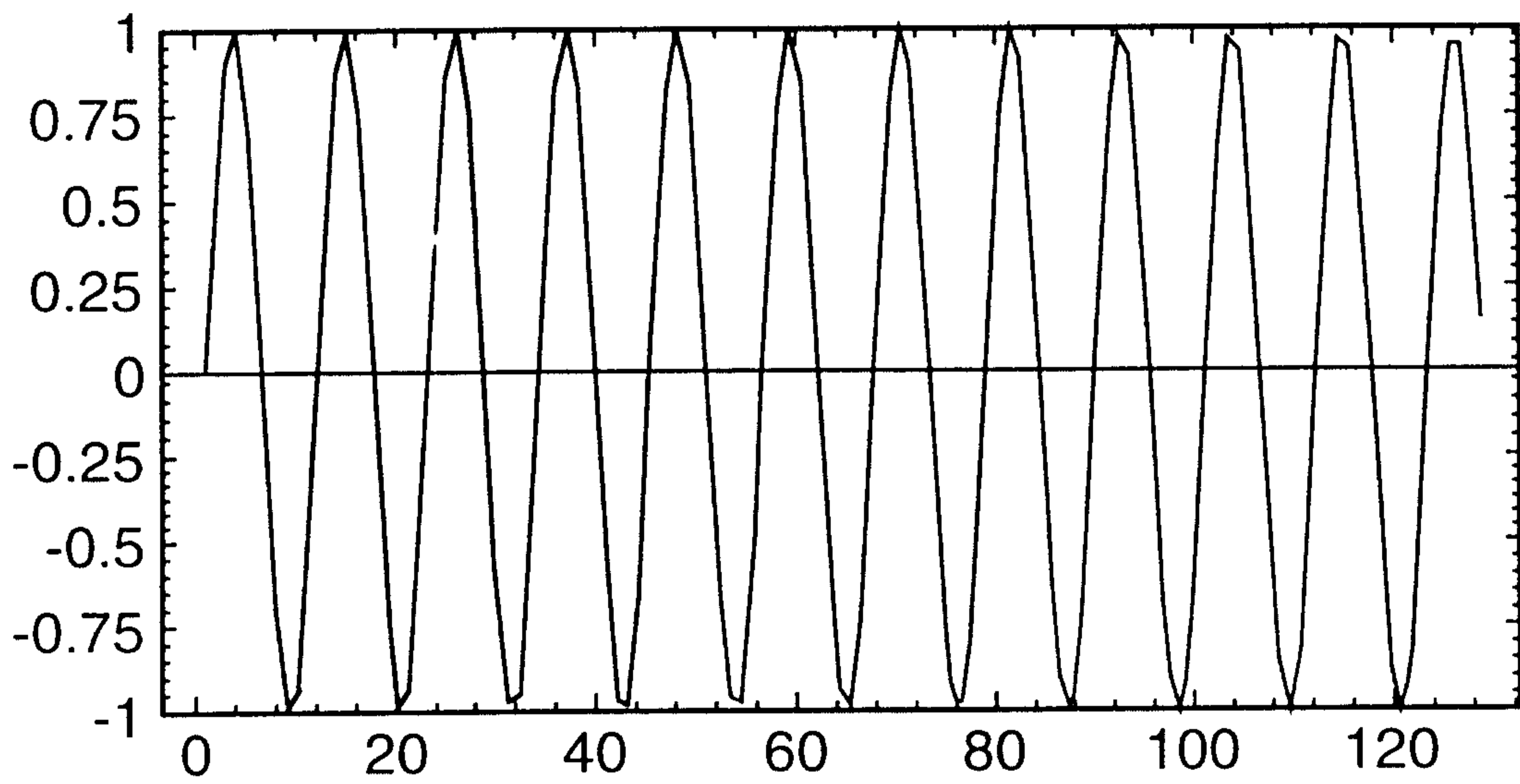

FIG.13.

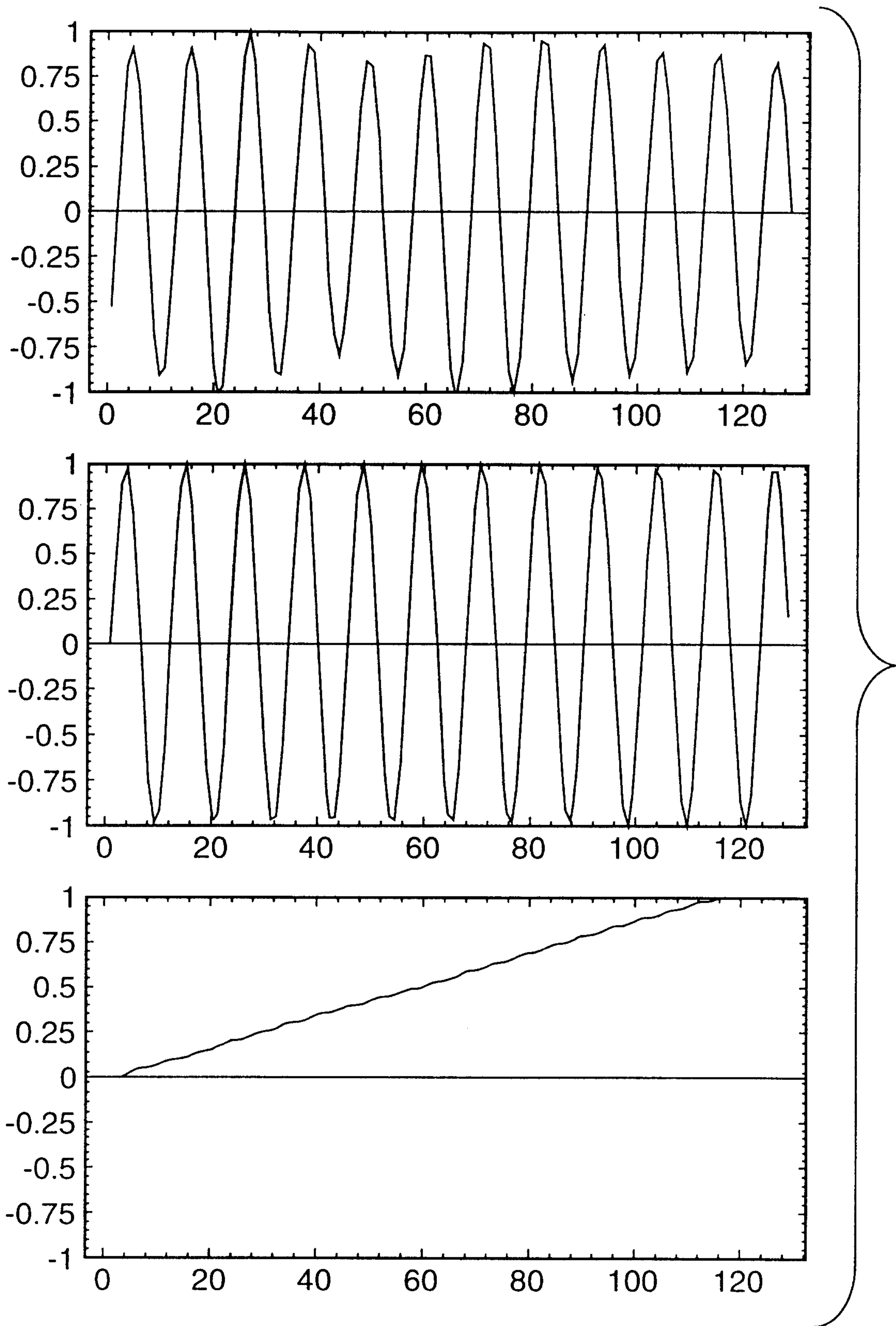

FIG.14.

21 170 53

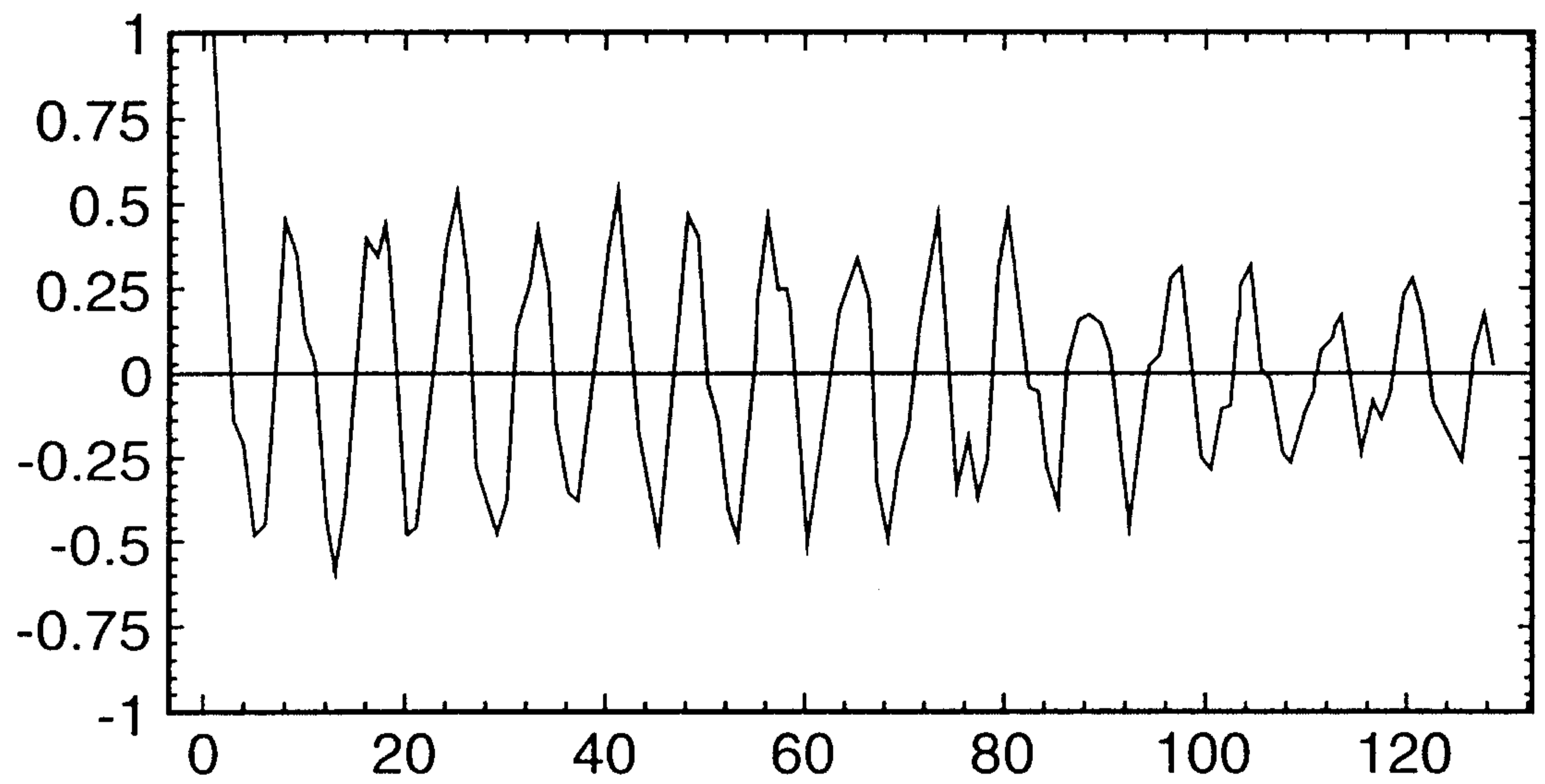
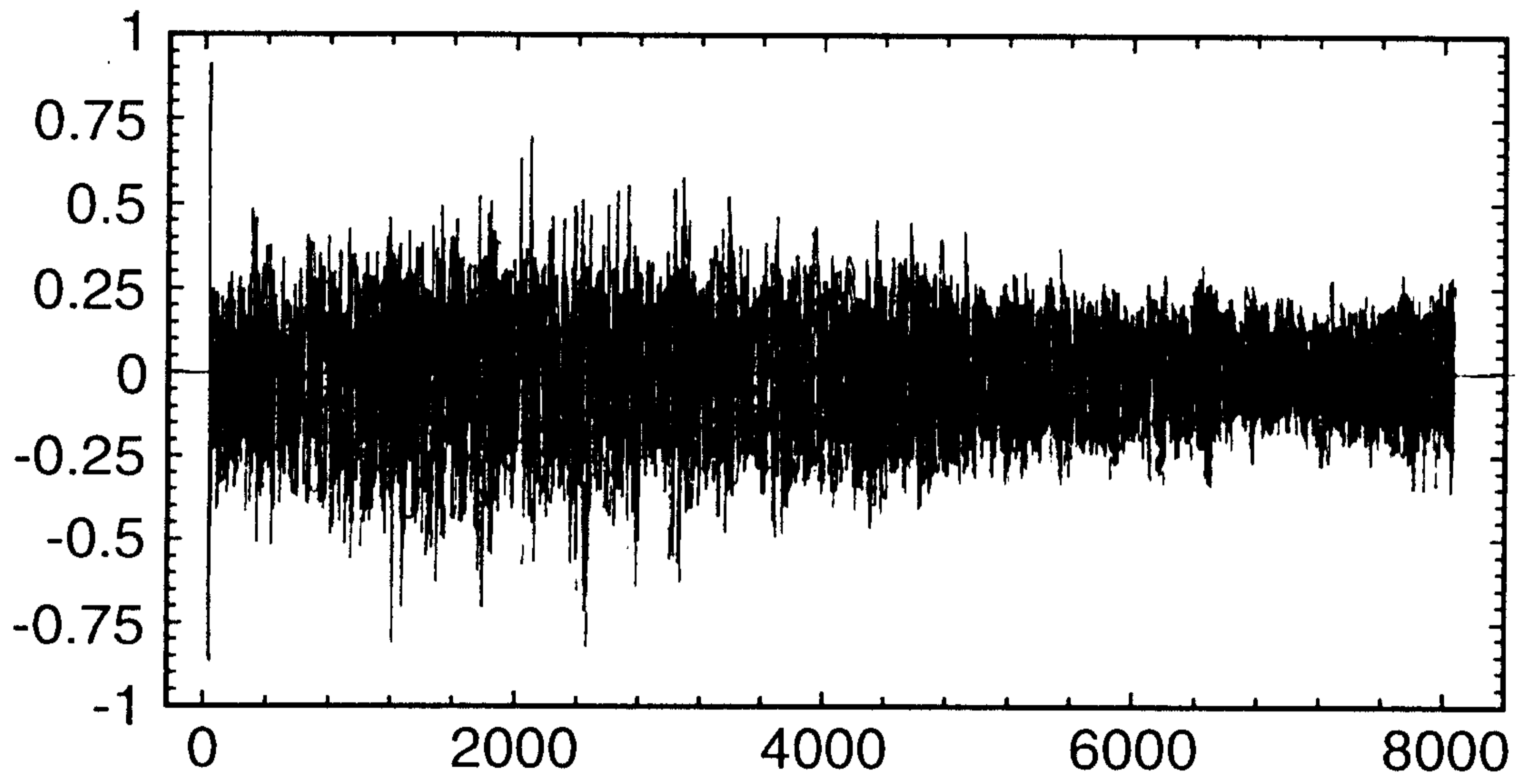

FIG.15.

2117053

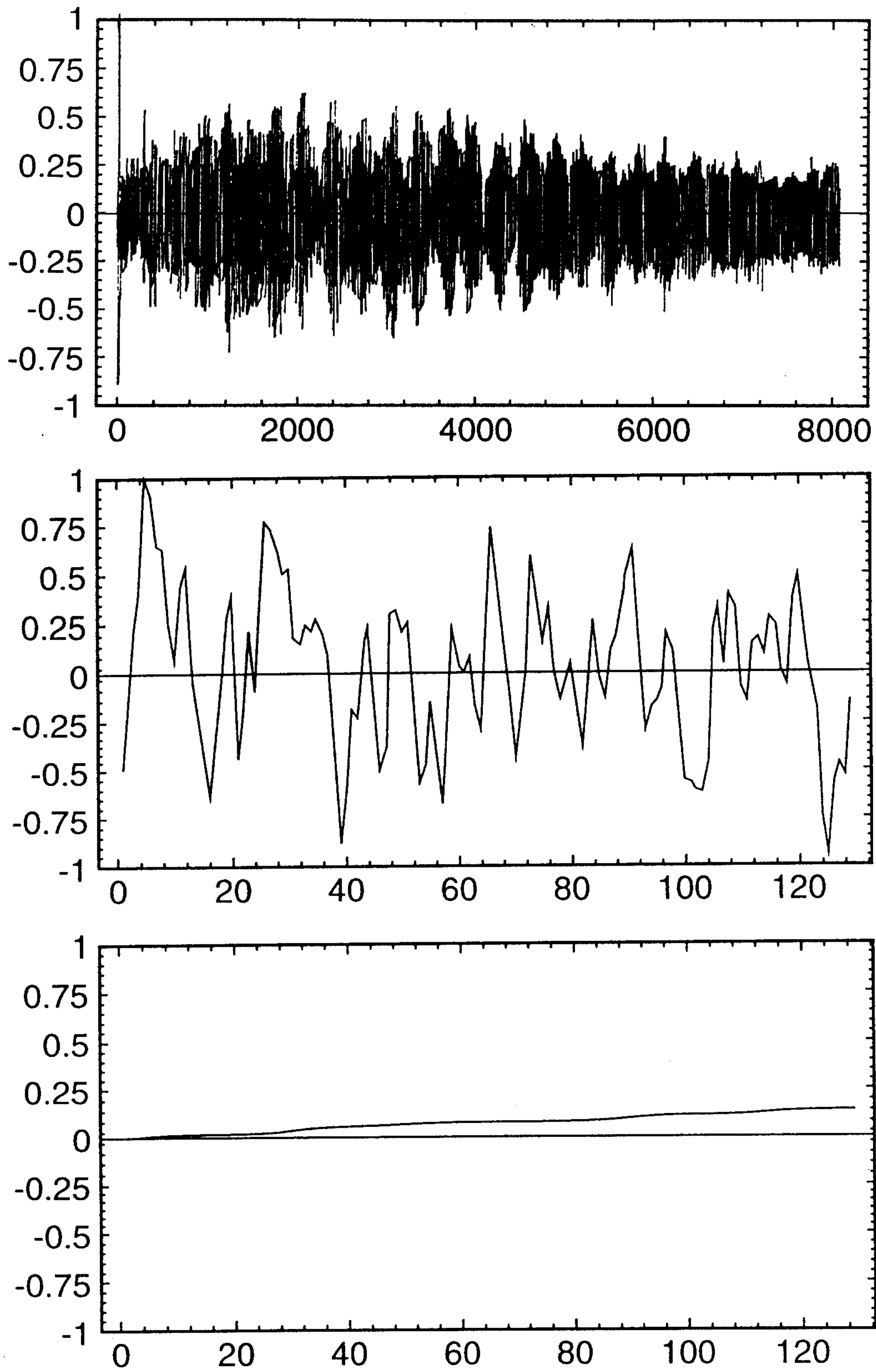

FIG.16.

2117053

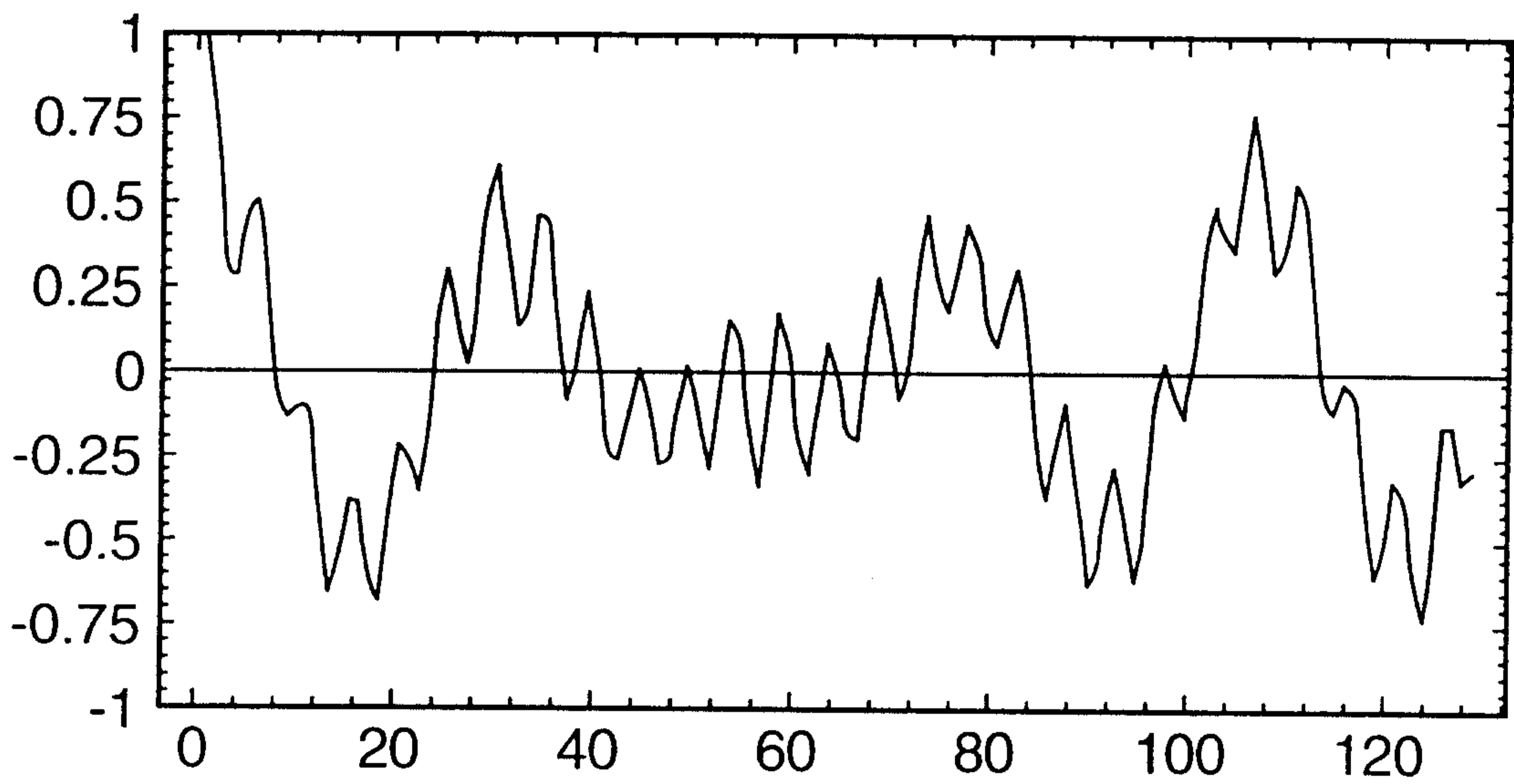
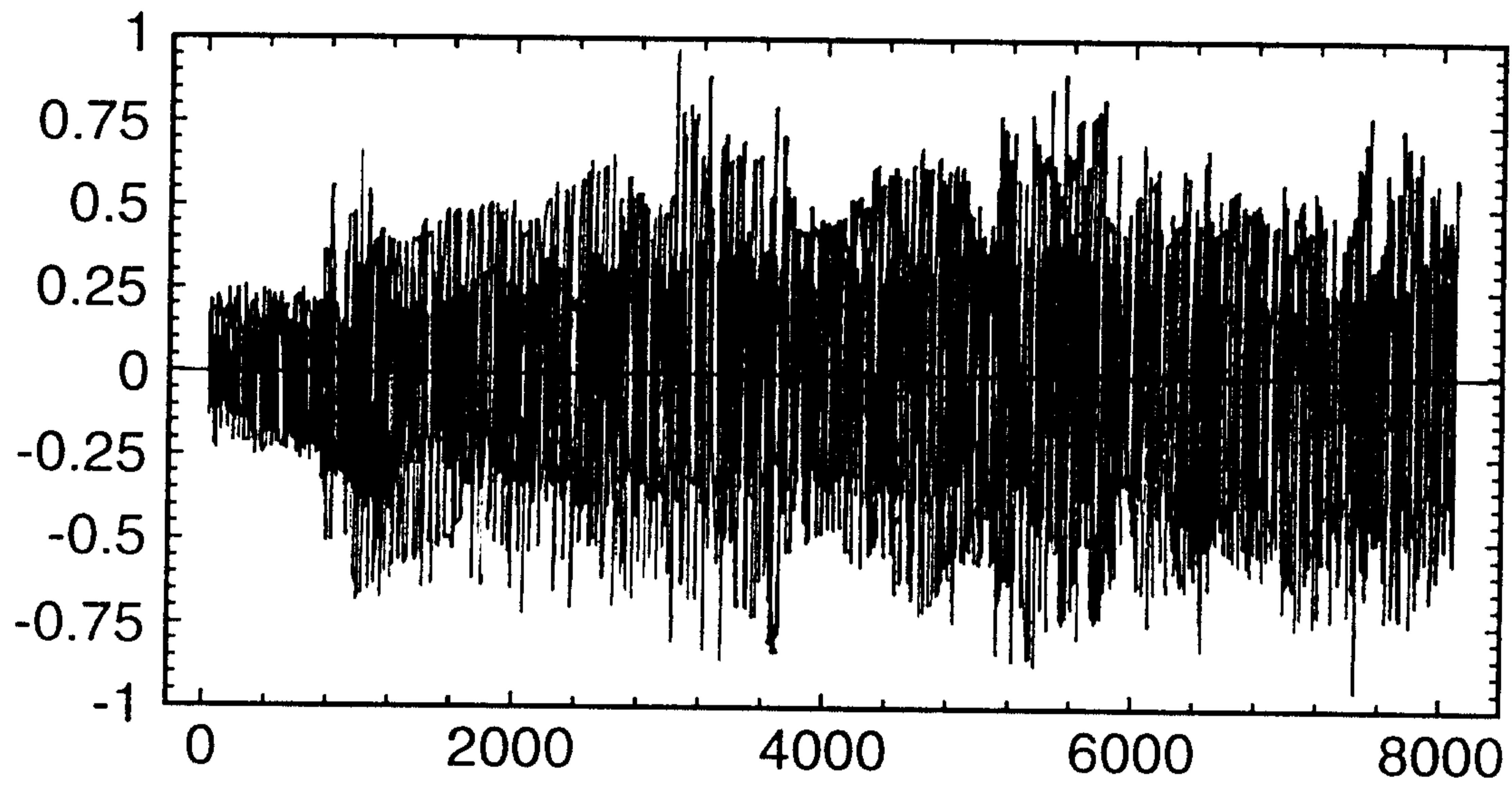

FIG.17.

2117053

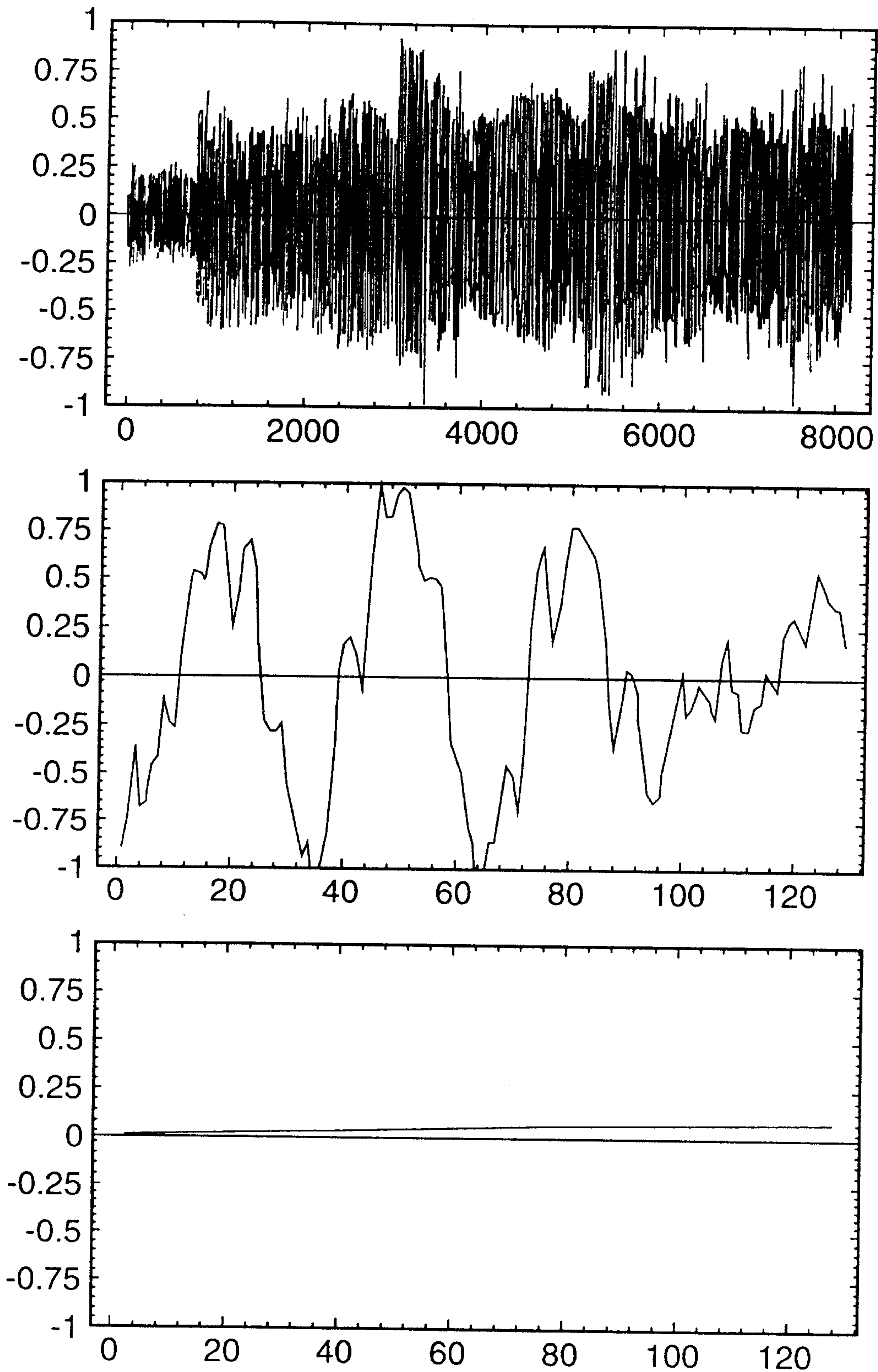

FIG.18.

A

2117053

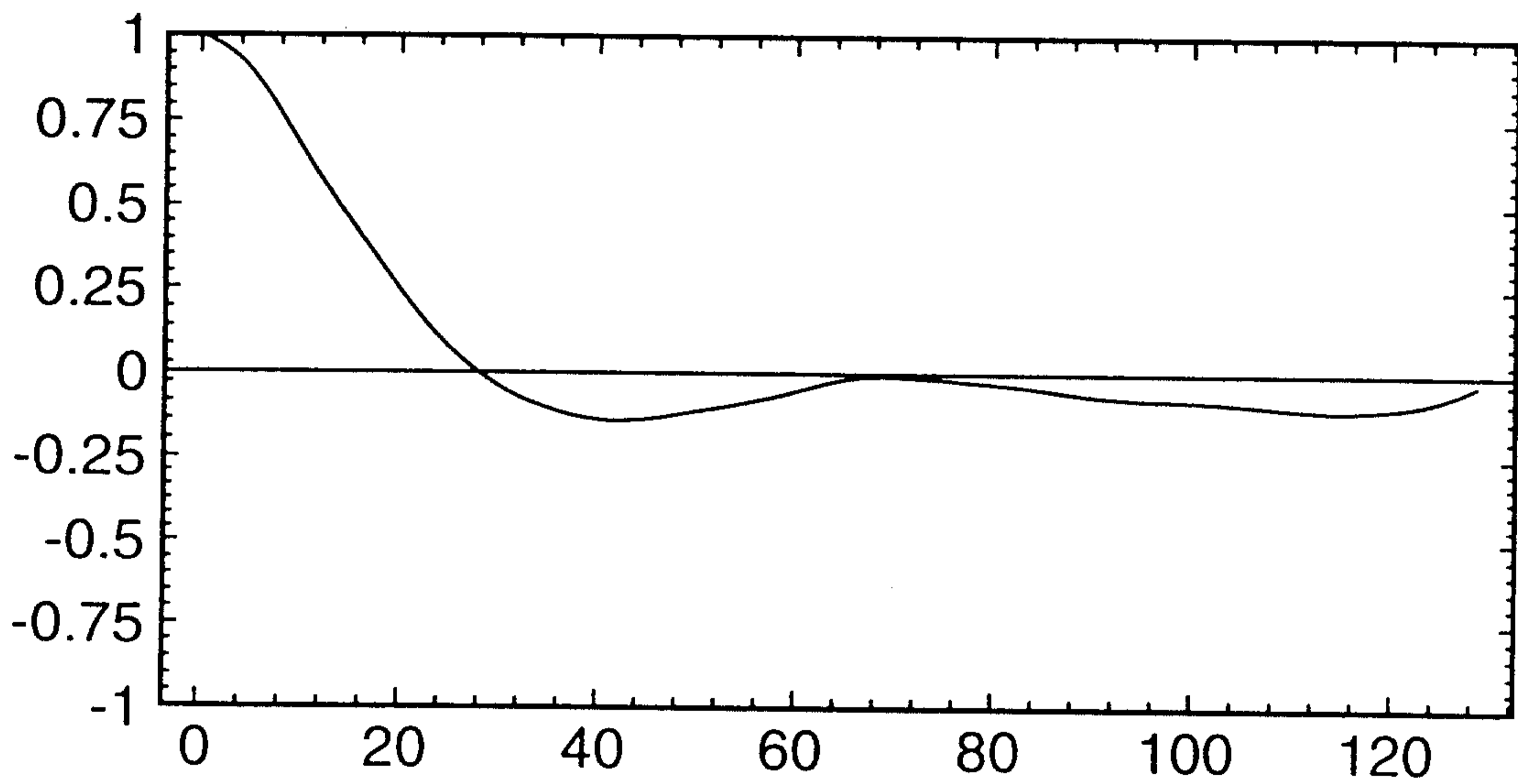
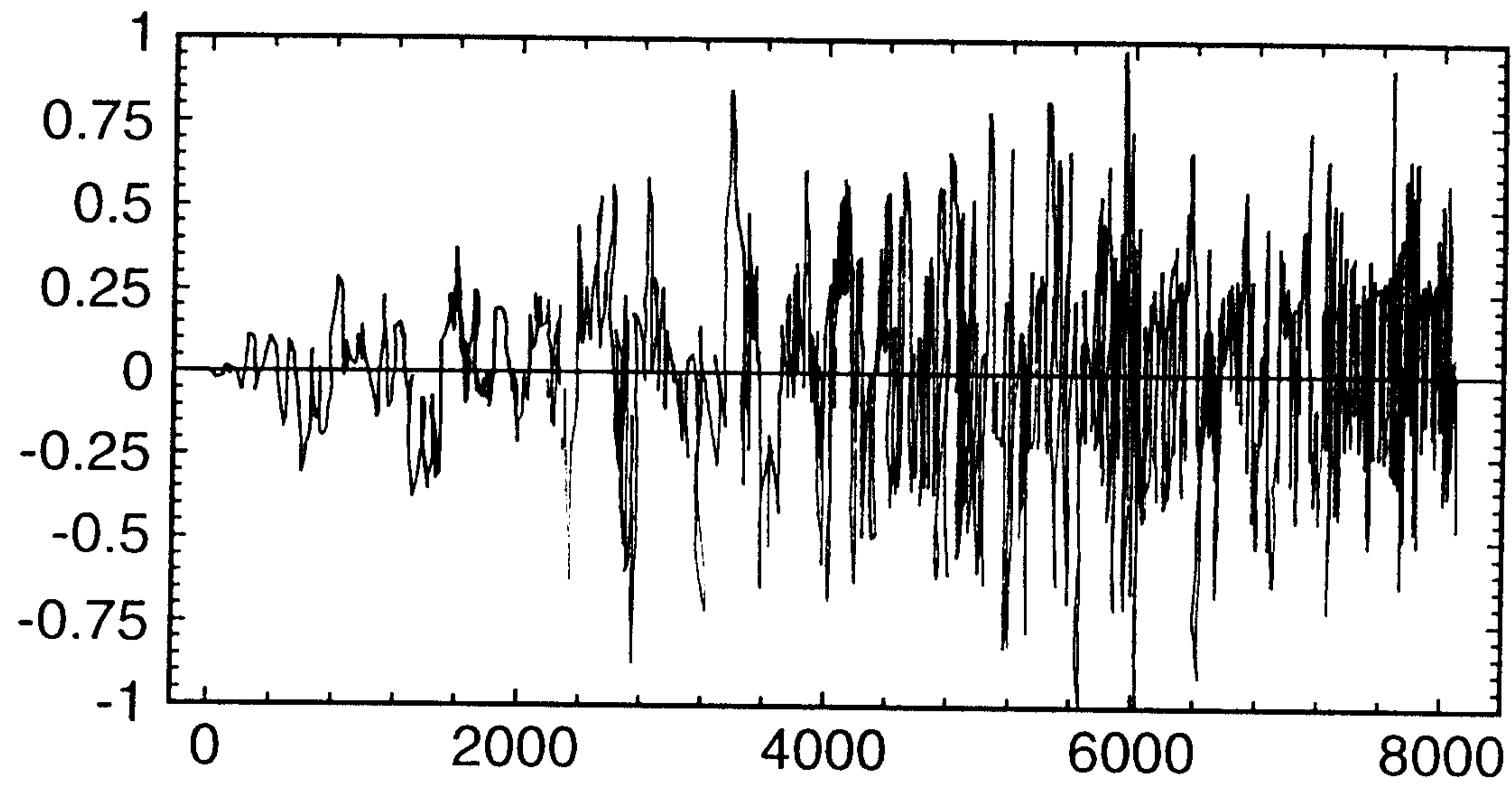

FIG.19.

2117053

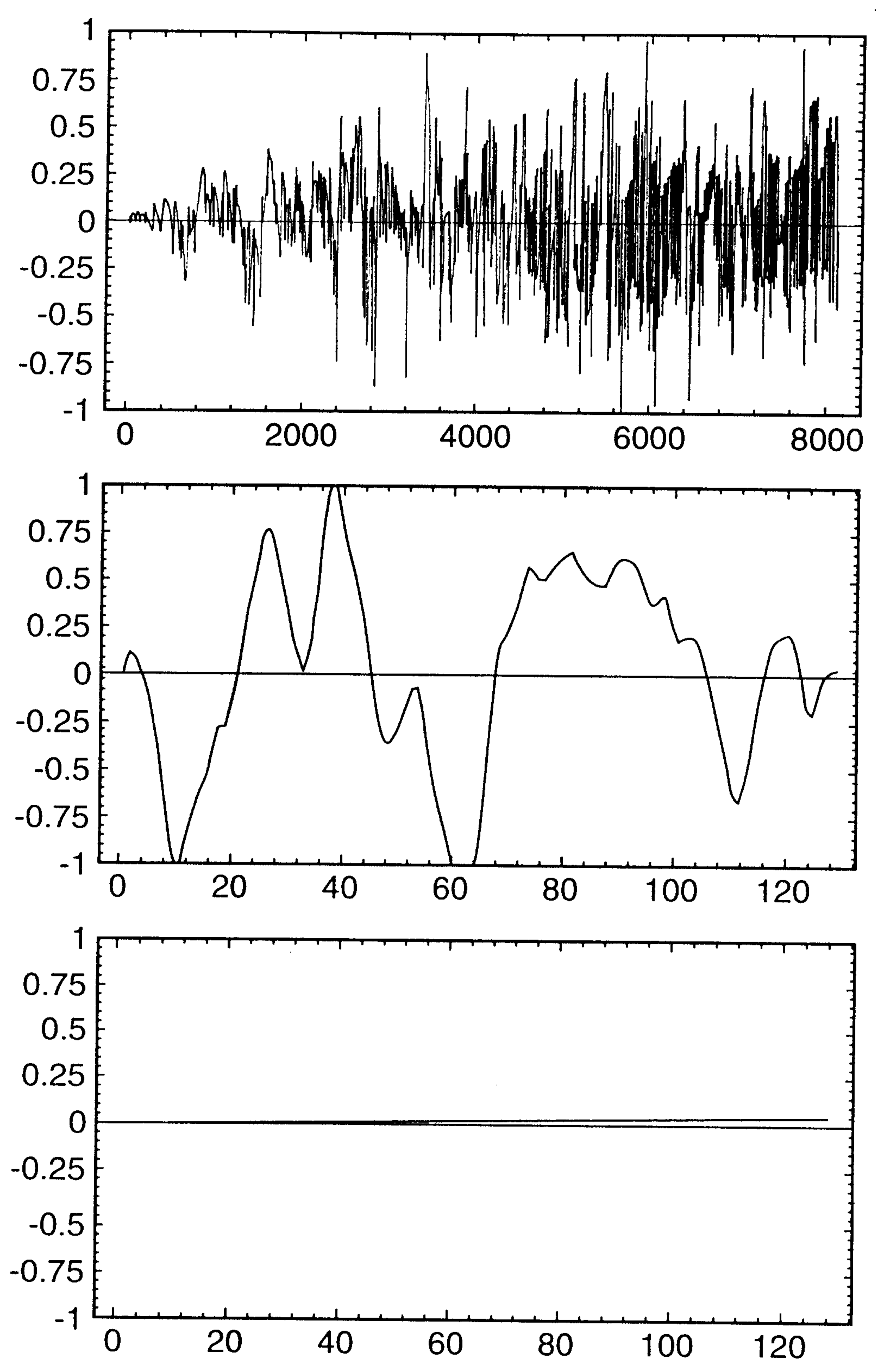

FIG.20.

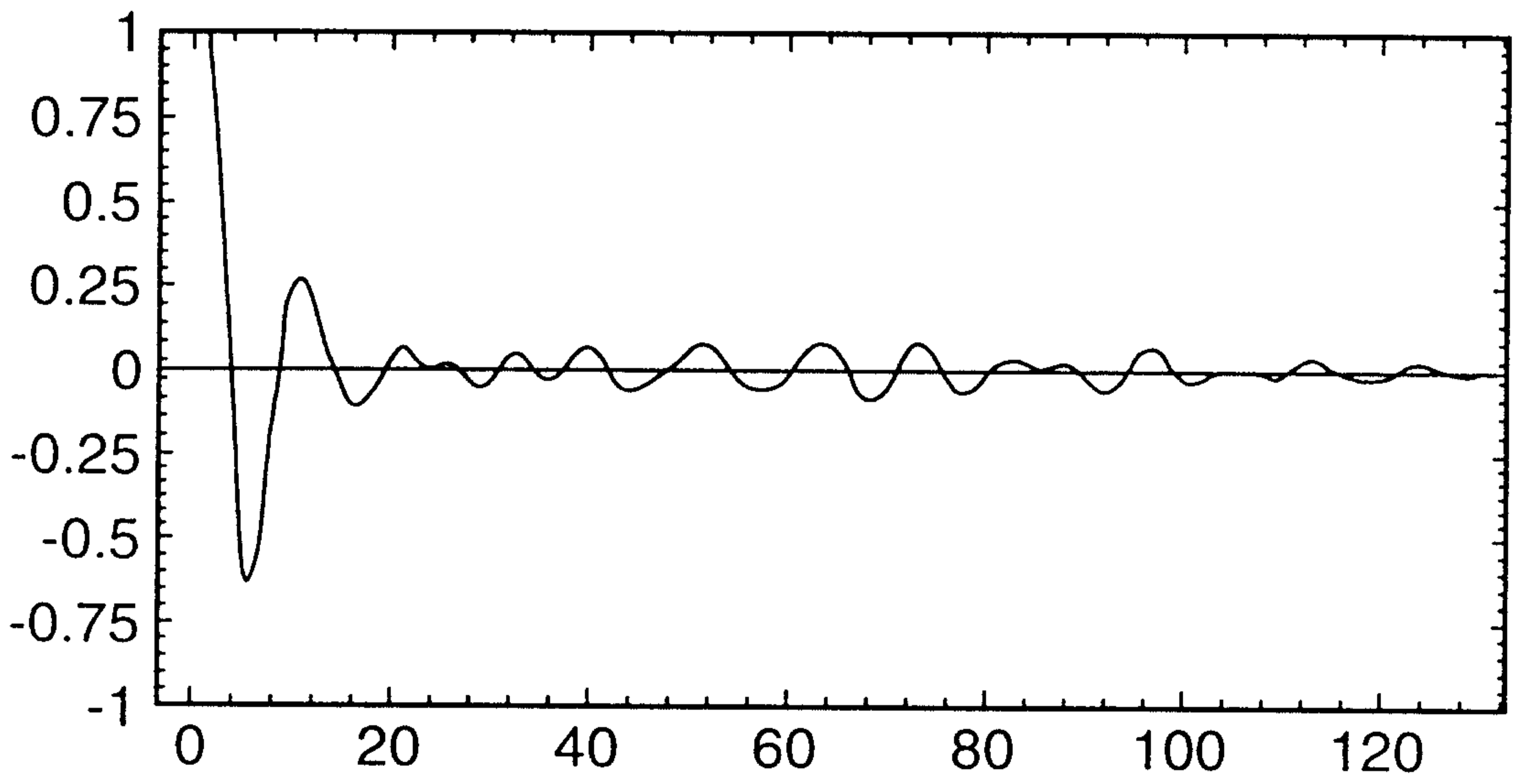
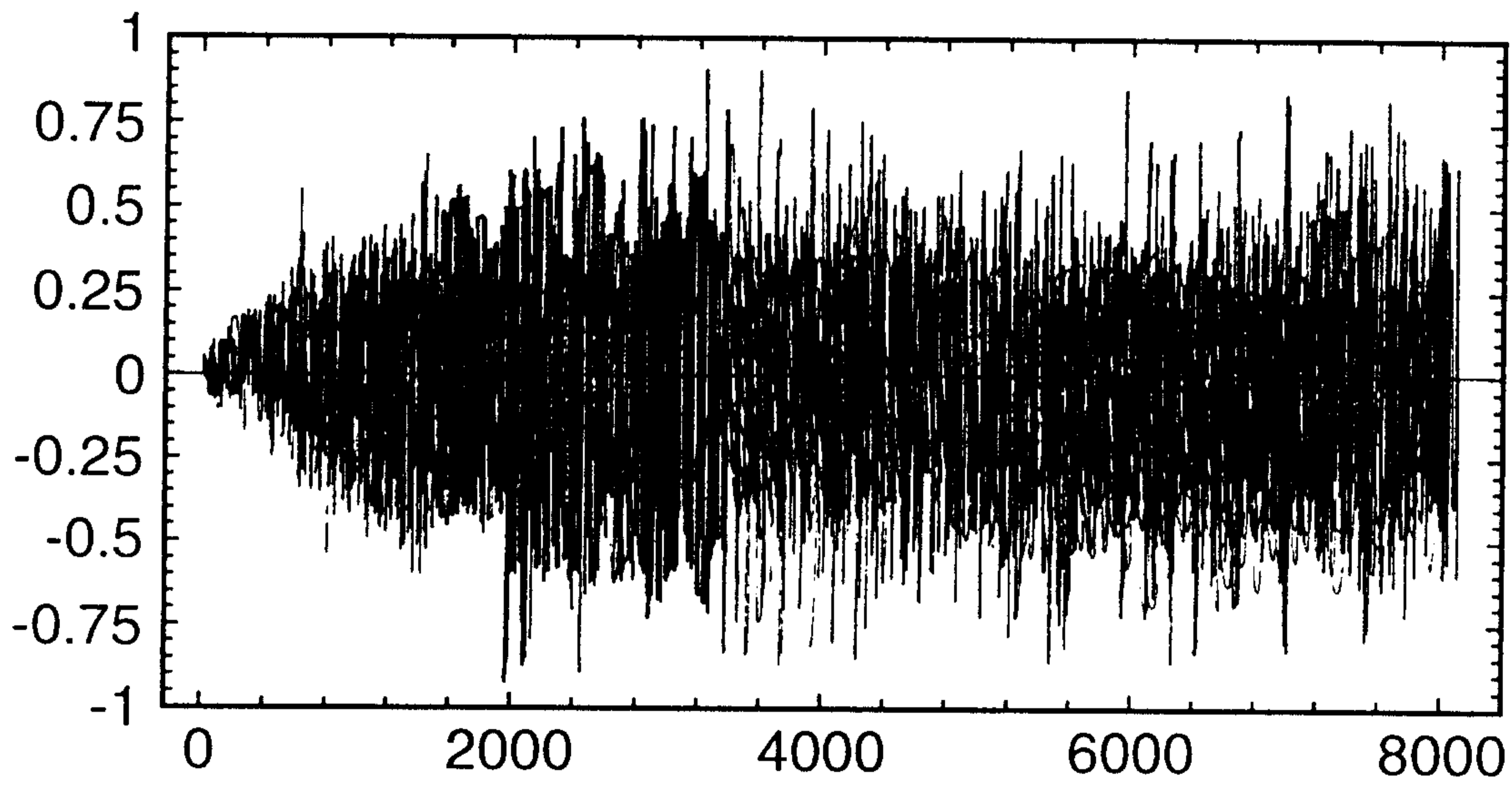

FIG.21.

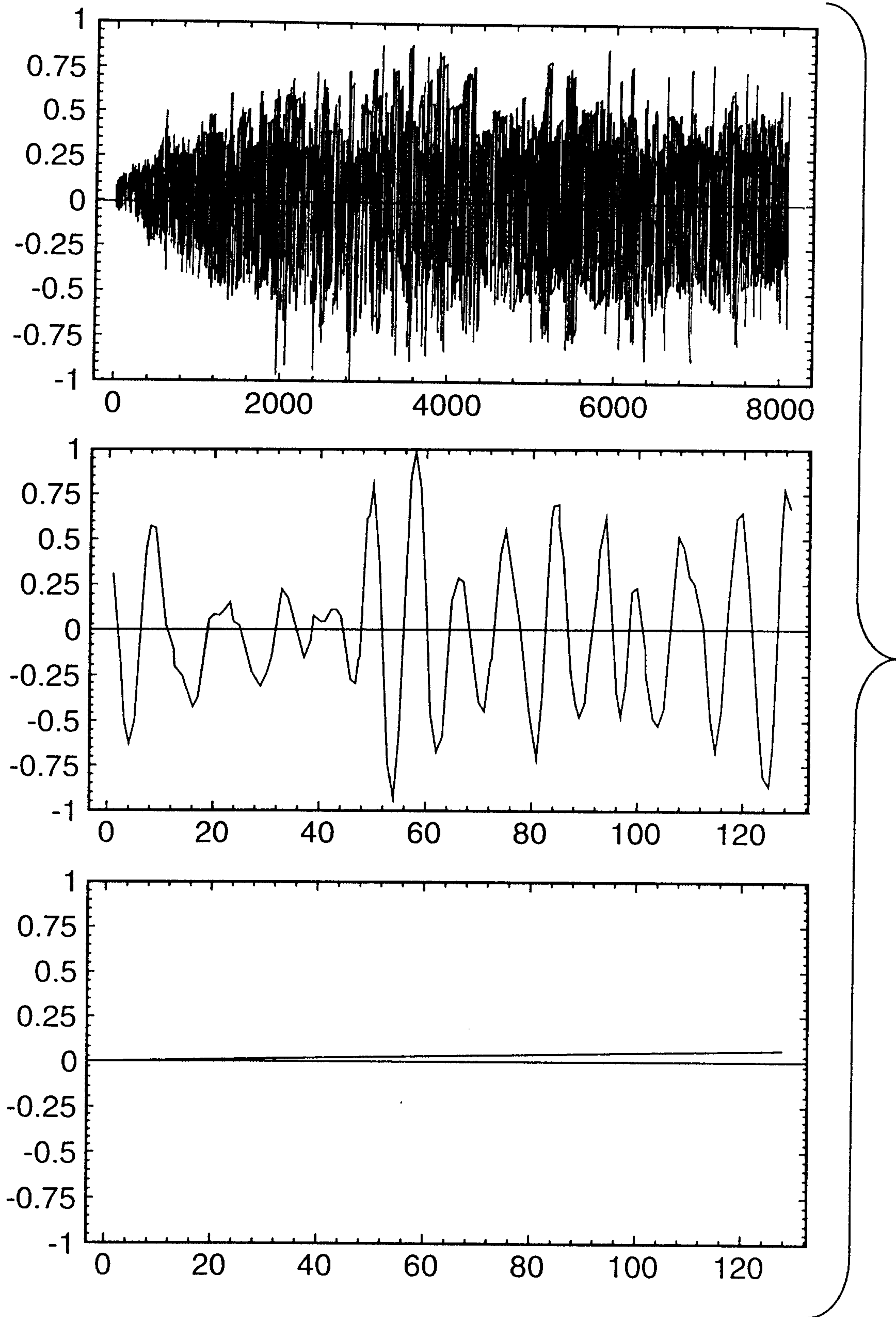

FIG.22.

2117053

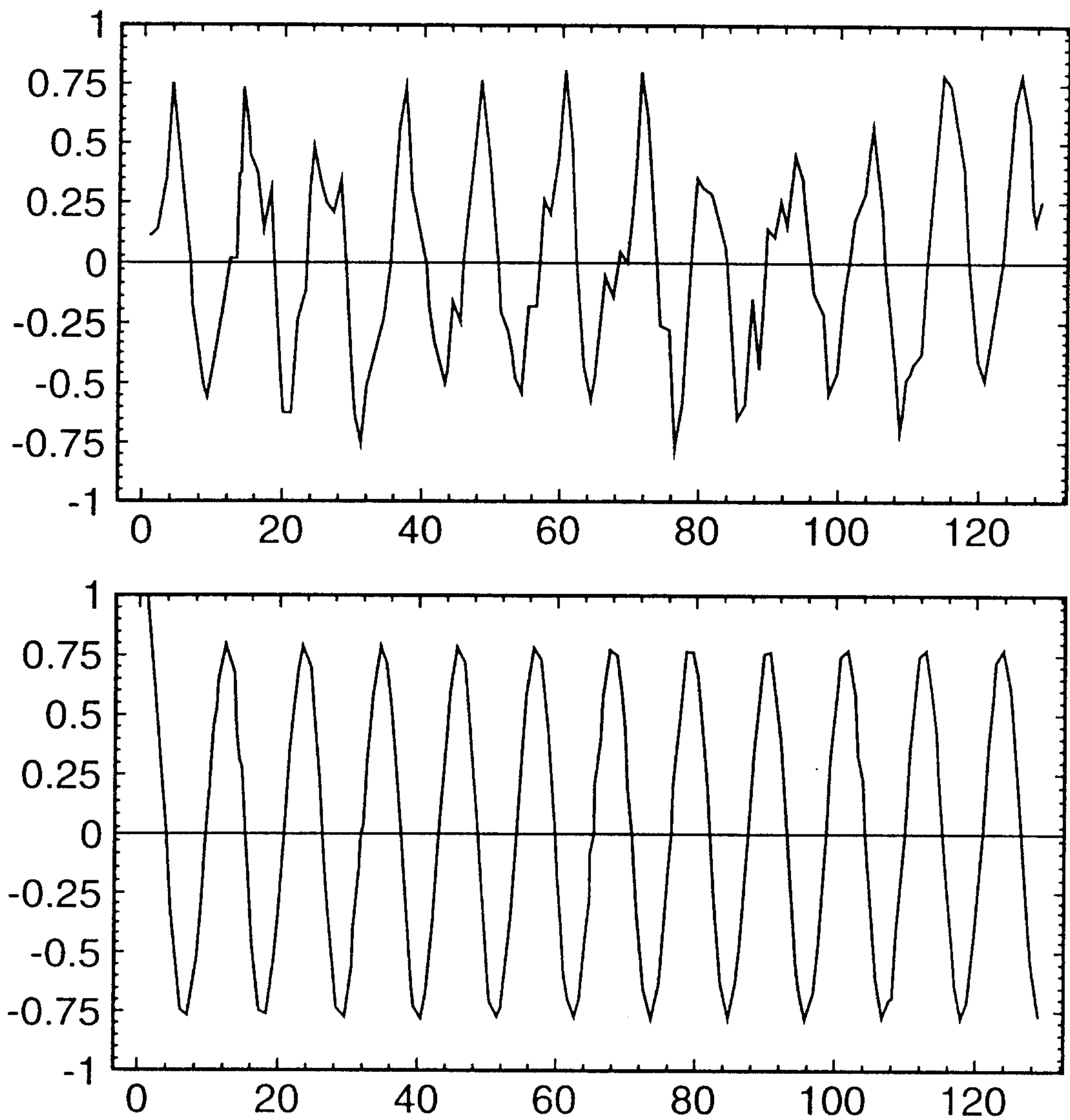

FIG.23.