



US00D802829S

(12) **United States Design Patent**
Reynolds

(10) **Patent No.:** **US D802,829 S**

(45) **Date of Patent:** **** Nov. 14, 2017**

(54) **HORTICULTURE GROW LIGHT**

FOREIGN PATENT DOCUMENTS

(71) Applicant: **IP Holdings, LLC**, Vancouver, WA
(US)

CA 2034710 8/1991
CA 1314529 3/1993

(Continued)

(72) Inventor: **Christopher Reynolds**, Vancouver, WA
(US)

OTHER PUBLICATIONS

(73) Assignee: **IP Holdings, LLC**, Vancouver, WA
(US)

Apollo Horticulture GLRCTAC 6" Air Cool Tube Grow Light Deluxe Glass Cylinder with Hood Reflector, image post date Oct. 15, 2010, site visted Oct. 3, 2014, (online), <http://www.amazon.com/apollo-horticulture-glrcac-cylinder-reflector/dp/b003qkvv04/ref=pd_sbs_lg_5?ie=utf8&refrid=1y9v9qhh4n5vnctjmfr>.

(Continued)

(**) Term: **15 Years**

(21) Appl. No.: **29/593,778**

(22) Filed: **Feb. 13, 2017**

Primary Examiner — Brian N Vinson

(74) *Attorney, Agent, or Firm* — J. Douglas Wells

Related U.S. Application Data

(63) Continuation of application No. 29/572,282, filed on Jul. 26, 2016, now Pat. No. Des. 781,492, which is a
(Continued)

(57) **CLAIM**

The ornamental design for a horticulture grow light, as shown and described.

(51) **LOC (10) Cl.** **29-99**

(52) **U.S. Cl.**

USPC **D26/118**

(58) **Field of Classification Search**

USPC ... D26/9, 10, 12, 13, 15, 16, 24, 51, 61, 72, D26/76, 80, 81, 85, 86, 88, 90, 113, 118, D26/119, 120, 122, 128, 129, 138, 143, D26/144

CPC B60Q 1/04; B60Q 1/26; F21S 8/026; F21S 8/04; F21V 29/004; F21V 21/02; F21V 21/04; F21V 29/2212; F21V 7/22; F21V 29/83; F21V 37/002; F21V 7/00; F21L
(Continued)

DESCRIPTION

FIG. 1 is a perspective view of a horticulture grow light, as viewed from below, showing my new design;
FIG. 2 is a perspective view of the light shown in FIG. 1, as viewed from above;
FIG. 3 is a left side view of the light shown in FIG. 1;
FIG. 4 is a right side view of the light shown in FIG. 1;
FIG. 5 is a front elevation view of the light shown in FIG. 1;
FIG. 6 is a rear elevation view of the light shown in FIG. 1;
FIG. 7 is a bottom plan view of the light shown in FIG. 1; and,
FIG. 8 is a top plan view of the light shown in FIG. 1.
The broken-line disclosure shown in the views is understood to represent portions of the article in which the claimed design is embodied, but which form no part of the claimed design.

(56) **References Cited**

U.S. PATENT DOCUMENTS

D32,722 S 7/1861 Schmidlin
D46,253 S 8/1914 Kopp

(Continued)

1 Claim, 6 Drawing Sheets

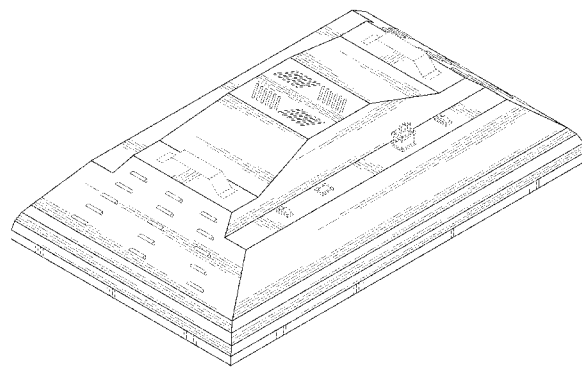
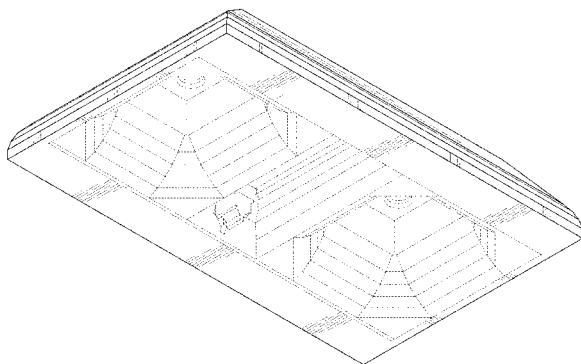

Related U.S. Application Data

continuation of application No. 29/531,242, filed on Jun. 24, 2015, now Pat. No. Des. 770,670.

(58) **Field of Classification Search**

CPC 19/00; F23D 11/443; F21Y 2101/02; A61L 9/037

See application file for complete search history.

(56) **References Cited**

U.S. PATENT DOCUMENTS

1,410,945	A	3/1922	Mayfield	4,970,428	A	11/1990	Hayakawa
1,547,026	A	7/1925	Canney	4,980,809	A	12/1990	Baldwin
1,798,567	A	3/1931	Wagenhorst	D316,301	S	4/1991	Michael
D85,049	S	9/1931	Kopp	5,006,752	A	4/1991	Eggink
D85,382	S	10/1931	Guth	5,065,294	A	11/1991	Poot
1,848,734	A	3/1932	Luce	5,072,349	A	12/1991	Waniga
1,873,310	A	8/1932	Doane	D323,897	S	2/1992	Compton
1,930,070	A	10/1933	Zecher	5,088,015	A	2/1992	Baggio
1,987,705	A	1/1935	Pedersen	D329,104	S	9/1992	Dieperink
D106,614	S	10/1937	Waterbury	D330,438	S	10/1992	Herst
2,194,841	A	3/1940	Welch	5,192,129	A	3/1993	Figuroa
D119,800	S	4/1940	Carter	5,199,784	A	4/1993	Hempleman
D123,768	S	12/1940	Scribner	5,253,152	A	10/1993	Yang
D125,559	S	3/1941	Biller	D349,358	S	8/1994	Herst
2,242,590	A	5/1941	Marcel	5,353,746	A	10/1994	Del Rosario
D128,049	S	7/1941	Kurtz	D352,126	S	11/1994	Ruud
D135,375	S	3/1943	Biller	5,440,470	A	8/1995	Ly
2,339,100	A	1/1944	Netting	5,457,450	A	10/1995	Deese
2,348,617	A	5/1944	Furedy	5,461,554	A	10/1995	Leonetti
D156,014	S	11/1949	Lazerson	D365,159	S	12/1995	Tinen
2,492,946	A	1/1950	Barber	5,486,737	A	1/1996	Hrubowchak
D174,221	S	3/1955	Hatch	5,510,676	A	4/1996	Cottaar
2,740,883	A	4/1956	Kruger	D373,000	S	8/1996	Brady
2,741,694	A	4/1956	Wiig	5,555,162	A	9/1996	Shemitz
2,998,511	A	8/1961	Chan	D374,301	S	10/1996	Kleffman
3,025,391	A	3/1962	Golko	5,568,680	A	10/1996	Parker
D193,802	S	10/1962	Thomsen	5,570,947	A	11/1996	Felland
D195,012	S	4/1963	Hoyle	D376,437	S	12/1996	Karlo
3,125,301	A	3/1964	Stotter	D377,993	S	2/1997	Herst
3,263,071	A	7/1966	Fabbri	5,621,267	A	4/1997	Shaffner
3,272,978	A	9/1966	Jackson	D383,243	S	9/1997	Fry
3,322,946	A	5/1967	Cooper	5,698,947	A	12/1997	Choi
3,420,995	A	1/1969	Dunckel	5,702,179	A	12/1997	Sidwell
D213,391	S	2/1969	Bruno	D391,632	S	3/1998	Thomas
3,433,941	A	3/1969	Hall	D396,319	S	7/1998	Sutton
3,675,008	A	7/1972	Hill	D397,481	S	8/1998	Schafer
3,684,883	A	8/1972	Entwistle	D399,328	S	10/1998	Compton
3,701,898	A	10/1972	McNamara, Jr.	D399,329	S	10/1998	Compton
3,755,667	A	8/1973	Price	D399,587	S	10/1998	Compton
3,829,677	A	8/1974	DeLlano	D400,289	S	10/1998	Wardenburg
3,902,059	A	8/1975	McNamara, Jr.	5,816,694	A	10/1998	Ideker
3,911,265	A	10/1975	Landrum	D401,006	S	11/1998	Edwards
4,028,542	A	6/1977	McReynolds, Jr.	D405,976	S	2/1999	Beall
D245,016	S	7/1977	Barr	5,896,004	A	4/1999	Feldman
4,037,096	A	7/1977	Brendgord	5,924,789	A	7/1999	Thornton
4,078,169	A	3/1978	Armstrong	5,932,955	A	8/1999	Berger
4,175,360	A	11/1979	Mulvey	5,938,317	A	8/1999	Thornton
4,229,782	A	10/1980	Ruud	D415,304	S	10/1999	Brown
D259,738	S	6/1981	Boschetti	5,983,564	A	11/1999	Stragnola
4,308,573	A	12/1981	McNamara, Jr.	5,987,697	A	11/1999	Song
D262,659	S	1/1982	Latta	5,999,943	A	12/1999	Nori
D266,578	S	10/1982	Moshier	D418,626	S	1/2000	Herst
D268,287	S	3/1983	Boschetti	D419,248	S	1/2000	Lyons
D270,577	S	9/1983	DeVos	6,024,468	A	2/2000	Kassay
4,446,506	A	5/1984	Larson	6,042,250	A	3/2000	Stragnola
4,531,180	A	7/1985	Hernandez	6,051,927	A	4/2000	Graser
4,616,293	A	10/1986	Baliozian	6,053,624	A	4/2000	Cronk
4,669,033	A	5/1987	Lee	D425,237	S	5/2000	Scott
D290,662	S	7/1987	Basil	D425,652	S	5/2000	Brok
D300,877	S	4/1989	Cyr	D426,010	S	5/2000	Compton
4,855,884	A	8/1989	Richardson	6,061,690	A	5/2000	Nori
4,893,221	A	1/1990	Friedman	6,065,849	A	5/2000	Chen
4,933,821	A	6/1990	Anderson	6,070,173	A	5/2000	Huber
4,939,629	A	7/1990	Glanton	6,076,944	A	6/2000	Maranon
D311,597	S	10/1990	Poot	6,079,851	A	6/2000	Altman
				D428,516	S	7/2000	Reo D26/118
				6,094,919	A	8/2000	Bhatia
				6,111,739	A	8/2000	Wu
				6,152,579	A	11/2000	Reed
				D439,008	S	3/2001	Kim
				6,210,025	B1	4/2001	Schmidt
				6,230,497	B1	5/2001	Morris
				D443,198	S	6/2001	Snyder
				D443,949	S	6/2001	DiMonte
				6,247,830	B1	6/2001	Winnett
				D445,943	S	7/2001	Littman
				6,257,735	B1	7/2001	Baar
				6,267,483	B1	7/2001	Hembery
				D447,272	S	8/2001	Smith D26/118

(56)

References Cited

U.S. PATENT DOCUMENTS

8,905,575	B2 *	12/2014	Durkee	F21V 7/0008 362/218
D720,876	S	1/2015	Haverfield	
D721,844	S	1/2015	Lay	
D722,654	S	2/2015	Martone	
D725,819	S	3/2015	Reynolds	
D725,820	S	3/2015	Hargreaves	
8,967,821	B2	3/2015	Pickard	
D726,359	S	4/2015	Grigore	
8,998,473	B1	4/2015	Anderson	
9,016,892	B1	4/2015	Scribante	
9,016,907	B2	4/2015	Stanley	
D728,848	S	5/2015	Reyes	
D729,435	S	5/2015	Arndt	
D730,556	S	5/2015	Toyohisa	
D731,103	S	6/2015	Wilke	
D731,109	S	6/2015	Wardenburg	
D731,701	S *	6/2015	Hargreaves	D26/118
D732,233	S	6/2015	Reynolds	
D732,234	S	6/2015	Rashidi Doust	
D732,235	S *	6/2015	Reynolds	D26/118
D732,236	S *	6/2015	Reynolds	D26/118
D733,347	S	6/2015	Dungan	
D733,952	S	7/2015	Lay	
D733,960	S	7/2015	Howe	
D734,534	S	7/2015	Howe	
D735,391	S	7/2015	Blessitt	
D735,401	S	7/2015	Clements	
D736,450	S *	8/2015	Reynolds	D26/118
D737,498	S	8/2015	Stanley	
9,110,209	B2	8/2015	Blessitt	
D738,031	S	9/2015	Martins	
D739,595	S	9/2015	Reynolds	
9,127,826	B2	9/2015	Boyer	
D740,486	S *	10/2015	Stanley	D26/118
D740,996	S	10/2015	Tragatschnig	
D745,993	S	12/2015	Reynolds	
D747,029	S *	1/2016	Reynolds	D26/118
D747,538	S	1/2016	Hargreaves	
D747,825	S	1/2016	Reynolds	
D747,923	S	1/2016	Cornu	
D748,319	S	1/2016	Johnson	
D748,320	S	1/2016	Johnson	
D748,847	S	2/2016	Johnson	
D748,849	S *	2/2016	Stanley	D26/118
D748,850	S	2/2016	Johnson	
D749,773	S	2/2016	Waible	
D750,312	S	2/2016	Reynolds	
D750,313	S	2/2016	Reynolds	
D750,316	S *	2/2016	Reynolds	D26/118
9,255,690	B2	2/2016	Dimitriadis	
D750,831	S	3/2016	Clements	
D751,244	S *	3/2016	Reynolds	D26/118
D751,245	S	3/2016	Stanley	
D751,247	S *	3/2016	Reynolds	D26/118
D753,654	S	4/2016	Eastwood	
9,310,037	B2	4/2016	Cercone	
D756,016	S	5/2016	Hargreaves	
D756,023	S	5/2016	Hoffer	
D756,026	S	5/2016	Reynolds	
D757,323	S	5/2016	Reynolds	
D757,326	S	5/2016	Reynolds	
D757,346	S	5/2016	Stanley	
9,335,038	B2	5/2016	Stanley	
9,366,947	B2	6/2016	Miyata	
D762,320	S	7/2016	Reynolds	
D765,306	S	8/2016	Wardenburg	
D766,756	S	9/2016	Franc	
D769,513	S	10/2016	Reynolds	
D769,514	S	10/2016	Reynolds	
D770,079	S	10/2016	Stanley	
D770,082	S	10/2016	Reynolds	
D770,670	S	11/2016	Reynolds	
D770,671	S	11/2016	Reynolds	
D771,301	S	11/2016	Stanley	

D771,304	S	11/2016	Goltche
D773,107	S	11/2016	Stanley
D775,406	S	12/2016	Hargreaves
D775,760	S	1/2017	Reynolds
D780,985	S	3/2017	Stanley
D780,986	S	3/2017	Reynolds
D781,492	S	3/2017	Reynolds
D783,887	S	4/2017	Stanley
D786,488	S	5/2017	Reynolds
D786,489	S	5/2017	Stanley
D786,490	S	5/2017	Stanley
2002/0073285	A1	6/2002	Butterworth
2002/0141195	A1	10/2002	Peter
2003/0031011	A1	2/2003	Miller
2003/0191783	A1	10/2003	Wolczko
2004/0240214	A1	12/2004	Whitlow
2005/0117333	A1	6/2005	Yoshida
2005/0160481	A1	7/2005	Todd
2005/0233691	A1	10/2005	Horton
2006/0231081	A1	10/2006	Kirakosyan
2006/0232984	A1	10/2006	Schuknecht
2006/0282457	A1	12/2006	Williams
2007/0051321	A1	3/2007	Chang
2007/0070633	A1	3/2007	Eynden
2007/0228993	A1	10/2007	Stuer
2007/0246631	A1	10/2007	Brown
2007/0282806	A1	12/2007	Hoffman
2008/0059799	A1	3/2008	Scarлата
2008/0117617	A1	5/2008	Hargreaves
2008/0130304	A1	6/2008	Rash
2008/0205030	A1	8/2008	Hargreaves
2008/0205071	A1	8/2008	Townasley
2008/0212326	A1	9/2008	Chon
2008/0278950	A1	11/2008	Pickard
2008/0278957	A1	11/2008	Pickard
2009/0116250	A1	5/2009	Hargreaves
2009/0231840	A1	9/2009	Boehme
2009/0262540	A1	10/2009	Hargreaves
2009/0276478	A1	11/2009	Soman
2009/0310373	A1	12/2009	Burkhauser
2009/0316404	A1	12/2009	Mo
2009/0323335	A1	12/2009	Yang
2010/0214789	A1	8/2010	Hawkes
2010/0238661	A1	9/2010	Pfund
2010/0277908	A1	11/2010	Hu
2010/0277929	A1	11/2010	Hargreaves
2010/0295468	A1	11/2010	Pedersen
2010/0302768	A1	12/2010	Collins
2011/0169412	A1	7/2011	Yurich
2011/0203096	A1	8/2011	Hargreaves
2011/0259665	A1	10/2011	Morgan
2012/0051041	A1	3/2012	Edmond
2012/0092859	A1	4/2012	Gregoris
2012/0145699	A1	6/2012	McMahan
2012/0212883	A1	8/2012	Hargreaves
2012/0230035	A1	9/2012	Bradley, Jr.
2013/0077329	A1	3/2013	Hessling
2013/0083539	A1	4/2013	Dimitriadis
2013/0155685	A1	6/2013	Stanley
2013/0242573	A1	9/2013	Petrsoiki
2013/0250567	A1	9/2013	Edmond
2014/0378283	A1	12/2014	Qiu
2015/0023022	A1	1/2015	Stanley
2015/0098215	A1	4/2015	Torabifard
2015/0252992	A1	9/2015	Stanley
2015/0252993	A1	9/2015	Stanley
2015/0252994	A1	9/2015	Stanley
2015/0260381	A1	9/2015	Verfuert

FOREIGN PATENT DOCUMENTS

EP	0325003	7/1989
EP	0440274	8/1991
WO	02063210	8/2002
WO	03060379	7/2003
WO	2008018000	2/2008

(56)

References Cited

FOREIGN PATENT DOCUMENTS

WO	2009096775	8/2009
WO	2011119451	9/2011

OTHER PUBLICATIONS

Apollo Horticulture GLRLS24 6" Air Cooled Hydroponic Grow Light Glass Reflector Hood, image post date Oct. 15, 2010, site visited Oct. 3, 2014, (online), <http://www.amazon.com/apollo-horticulture-GLRLS24-hydroponic-reflector/dp/B00BMVK8HG/ref=cm_cd_ql_qh_dp_i>.

Adjustable Reflector, image post date Apr. 23, 2012, site visited Sep. 23, 2015, http://web.archive.org/web/2012043260757/http://hydroponics-products.en.alibaba.com/product/519225678-213056444/adjustable_reflector_grow_light_hydroponics_greenhouse_horticulture_reflector_hood.html.

Agrotech Magnum Reflector, image post date Feb. 5, 2012, site visited Oct. 31, 2014, www.hydroponics.net/i/136580.

Cree CR22, image post date Apr. 28, 2011, site visited Nov. 15, 2014, <http://ledsmagazine.com/content/dam/leds/migrated/objects/news/8/4/19/cree204272011.jpg>.

ZR series High Efficacy Troffer, image post date Apr. 13, 2012, site visited Oct. 31, 2014, www.cree.com/lighting/products.

Grow Lights Home Depot: Find many types of grow lights for your plant, published Dec. 22, 2012, online. Site visited Jun. 25, 2014. <http://besthomedecor.com/gardening-decor/grow-lights-home-depot-few-things-to-consider-when-buying-grow-lighting-plants-online.html>.

LED Grow Light Comparison Test Review, Youtube.com, published Jun. 29, 2012, online. Site visited Jun. 25, 2014. www.youtube.com/watch?v=f-8oy0qbgrs.

Illuminator Pro-Series Hybrid 350W, wordpress.com, published Dec. 22, 2010, online, site visited Jun. 25, 2014. <http://growsetup.wordpress.com/category/grow-lights/>.

California Lightworks New SolarStorm 440W LED Grow Light with UVB, hydrobuilder.com, online. Site visited Jun. 25, 2014. http://hydrobuilder.com/solarstorm-440w-led-grow-light-with-uvb.html?dzid=strands_CLW-SS-440.

2013 Sunlight Supply Cataog, Issuu.com, published Aug. 1, 2013, online. Site visited Feb. 2, 2015. http://issuu.com/sunlightsupply/docs/2013_sunlightproductcatalog/49.

Pages 29 and 54 from 2014-2015 dealer catalog showing and describing Super Sun DE reflector published by Sunlight Supply, Inc. 2014.

Dominator XXXL Non AC Reflector pack of 3 Spec Sheet, GreenTreesHydroponics.com, date available Mar. 12, 2014, online. Site visited Feb. 3, 2015, <https://www.hydroponics.net/i/141477>.

Low Rider Air-Cooled Reflector—TinEye, image post date Oct. 11, 2012, site visited Oct. 1, 2015, www.tineye.com/search/1b0e187c5ed9e4e9cfb55d0472271385a2c0e88/?pluginver.

OG Air Cooled Parabolic Reflector Only—Make the Most of Your Grow Light, GroWell Hydroponics, <http://www.growell.co.uk/og-air-cooled-parabolic-reflector-only.html>, pp. 1-2, accessed Aug. 26, 2014.

Air Resistance: Distinguishing Between Laminar and Turbulent Flow, www.docstoc.com, Dec. 29, 2010, pp. 1-6.

Sun Systems LEC 630 Light Emitting Ceramic Fixture, Spec Sheet for 906217—Sun System LEC 630 120 Volt w/3100 K Lamps, www.sunlightsupply.com/shop/bycategory/led-lighting/sun-system-lec-630-light-emitting-ceramic-fixture, online, updated Feb. 9, 2015. Site visited Mar. 30, 2015, p. 1.

Mohri, Mineko, International Preliminary Report on Patentability for PCT/US2014/014959, Jan. 19, 2016.

A3V Reflector, Titaness Light Shop, www.titanesslightshop.com/products-page/reflectors/a3v-reflector, online. Site visited Jan. 14, 2015.

G2V Grow Light Reflector, Titaness Light Shop, www.titanesslightshop.com/products-page/reflectors/g2v-grow-light-reflector, online. Site visited Jan. 14, 2015.

1000 Watt Galaxy Grow Amp Double Ended Grow Light Packages, image post date Jan. 30, 2014, sited visited Jul. 8, 2016, <<http://www.ehydroponics.com/100-watt-galaxy-grow-amp-double-ended-grow-light-package.html>>.

2009-10-watt-light-set—TinEye, image post date May 23, 2012, site visited Jul. 8, 2016, <<https://www.tineye.com/search/2de39cf51f7a031139a80ce555e2f30d0abd5216/>>.

Square 10 Watt LED Grow Light, image post date Aug. 1, 2011, site visited Jul. 8, 2016, <<http://www.dhgate.com/store/product/hydroponic-vegetable-10-watt-led-grow-light/216755031.html>>.

Sun System 630 Ceramic Metal Halide 120v Specifications, GrowersHouse.com, update on Sep. 9, 2014, Online. Site visited Feb. 3, 2015. <http://growershouse.com/aitdownloadablefiles/download/aithle/aifile_id/583/>.

Growlite HDE 600W-1000W Double Ended Lamp Concealed Vacuum Airflow Technology, Indoor Grow Science, site visited Aug. 3, 2016, <<http://www.indoorgrowscience.net/downloads/specs/hde.pdf>>.

Sun Systems LEC 315—Reviews?, rollitup.com forum, published Oct. 23, 2013, online. Visited Nov. 8, 2016. <<http://rollitup.org/t/sun-systems-lec-315-reviews.742794>>.

Sun System LEC 315 120v Light Emitting Ceramic Metal Halide Fixture w/ Free Ratchet Light Hangers, Amazon.com, earliest review of Jul. 2, 2014, online. Visited Nov. 8, 2016 <<https://www.amazon.com/sun-sysem-emitting-ceramic-fixture/dep/B00HBCV8TM>>.

LEC 315 Watt Grow Light Great Yield Reports!, YouTube.com, published Mar. 31, 2014, online. Visited Nov. 8, 2016. <<https://www.youtube.com/watch?v=QqcoW19KnUk>>.

Air Cooled Grow Lights, greensteamhydroponics.com, published May 24, 2014, online. Site visited Nov. 16, 2016. <http://web.archive.org/web/20140524103407/http://www.greensteamhydroponics.com/aircooled-reflector-range-from-greenstream-hydroponics/prod_699.html>.

* cited by examiner

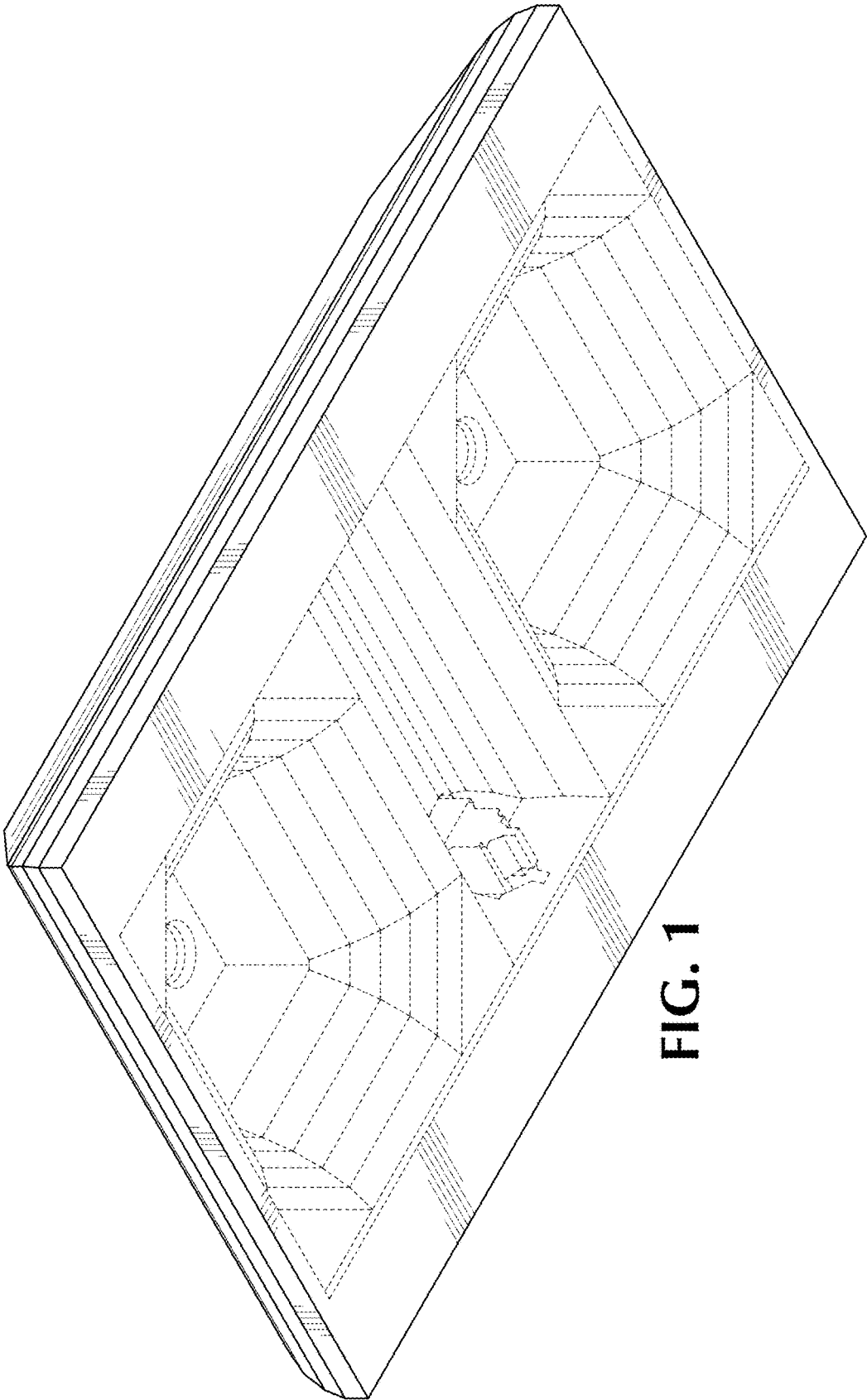

FIG. 1

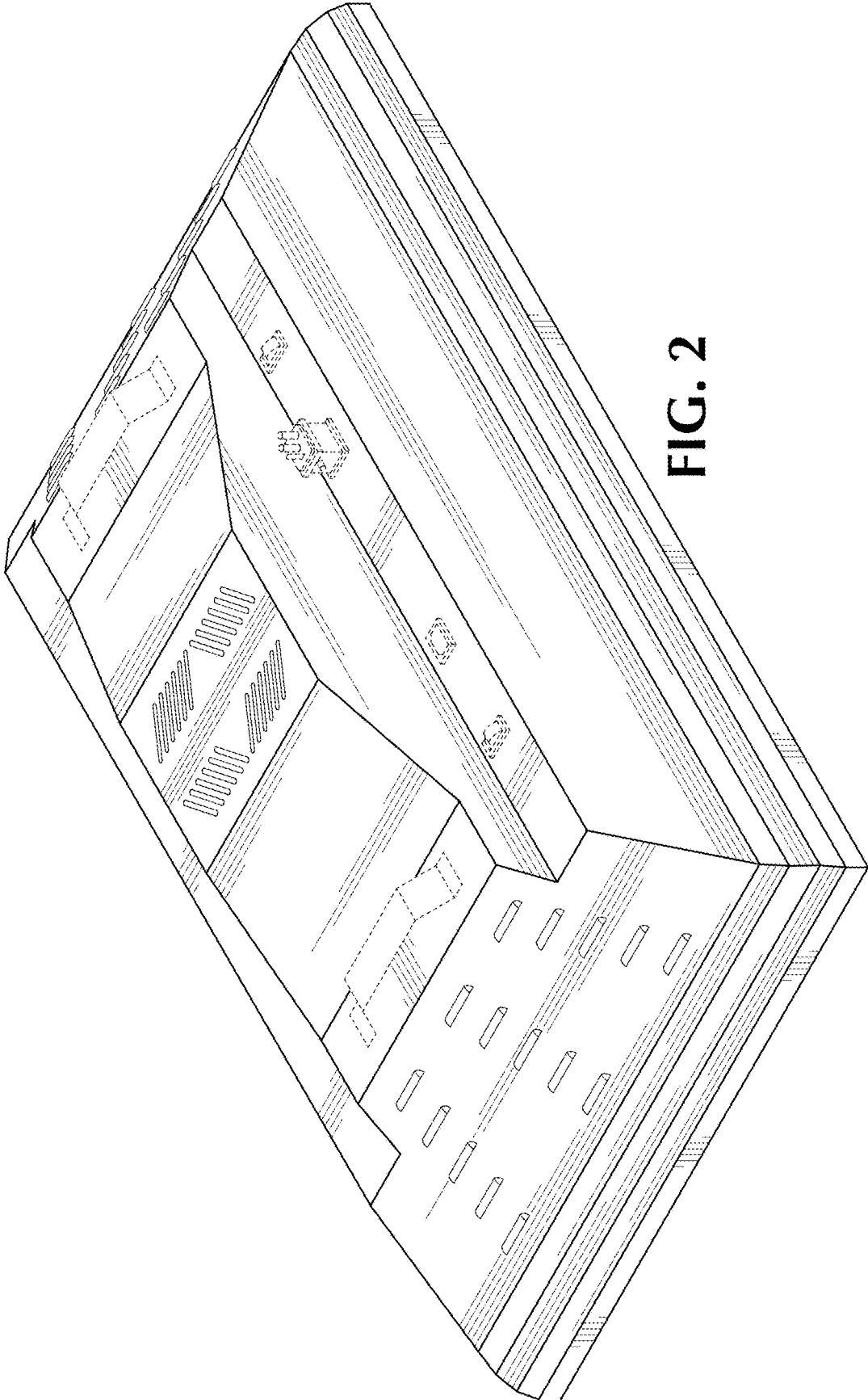

FIG. 2

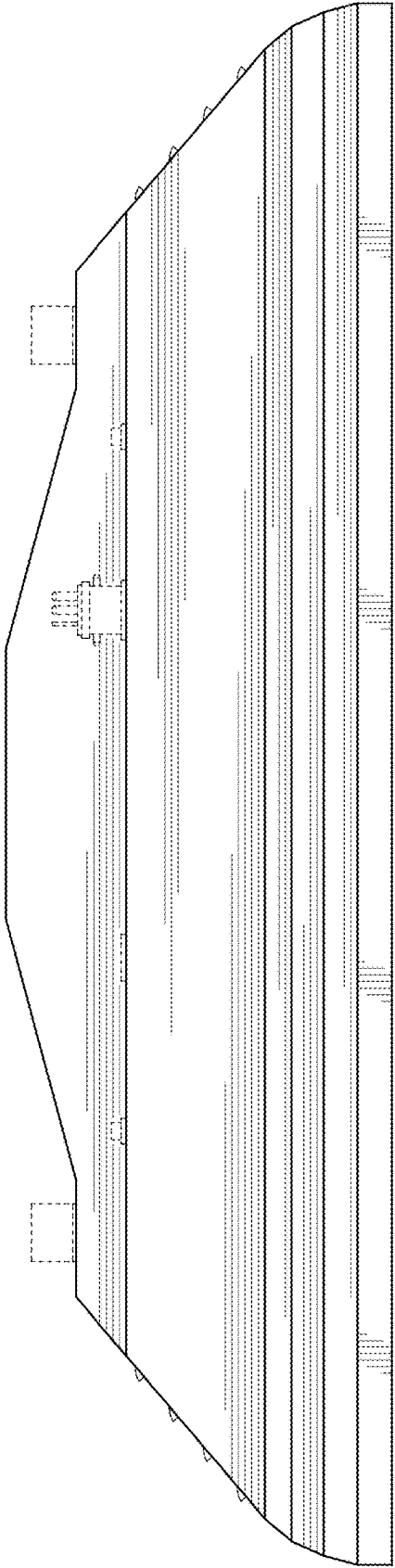

FIG. 3

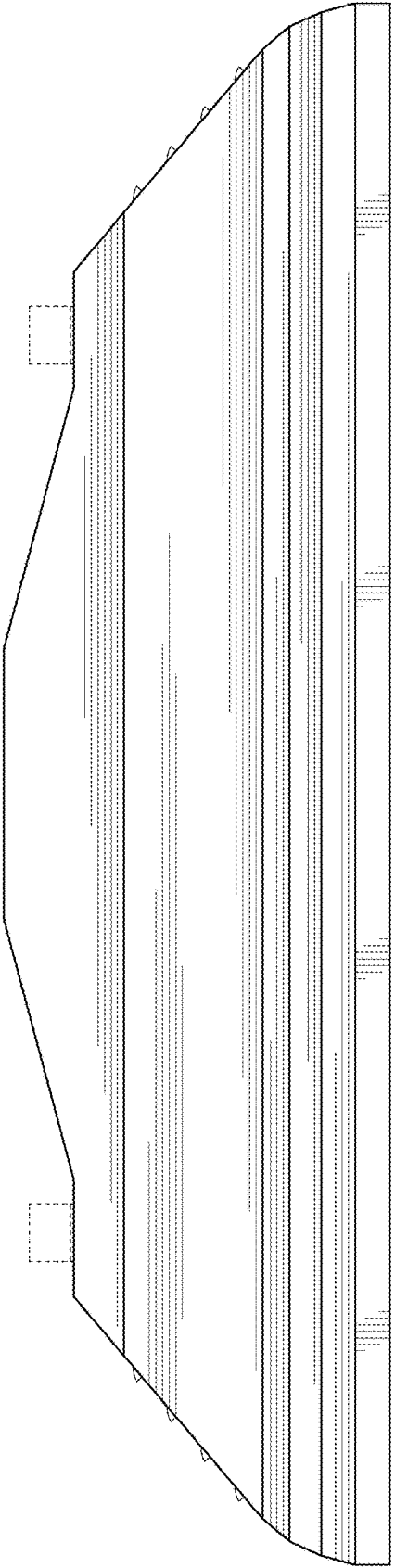

FIG. 4

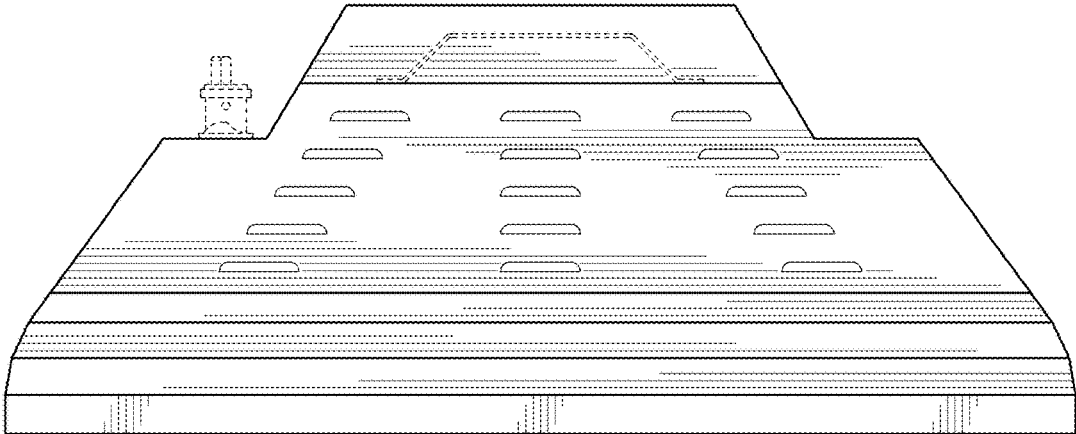

FIG. 5

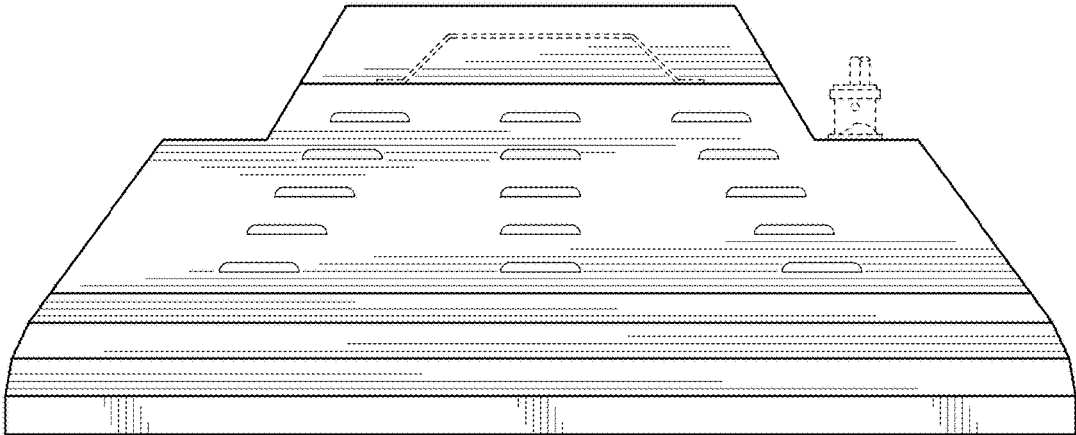

FIG. 6

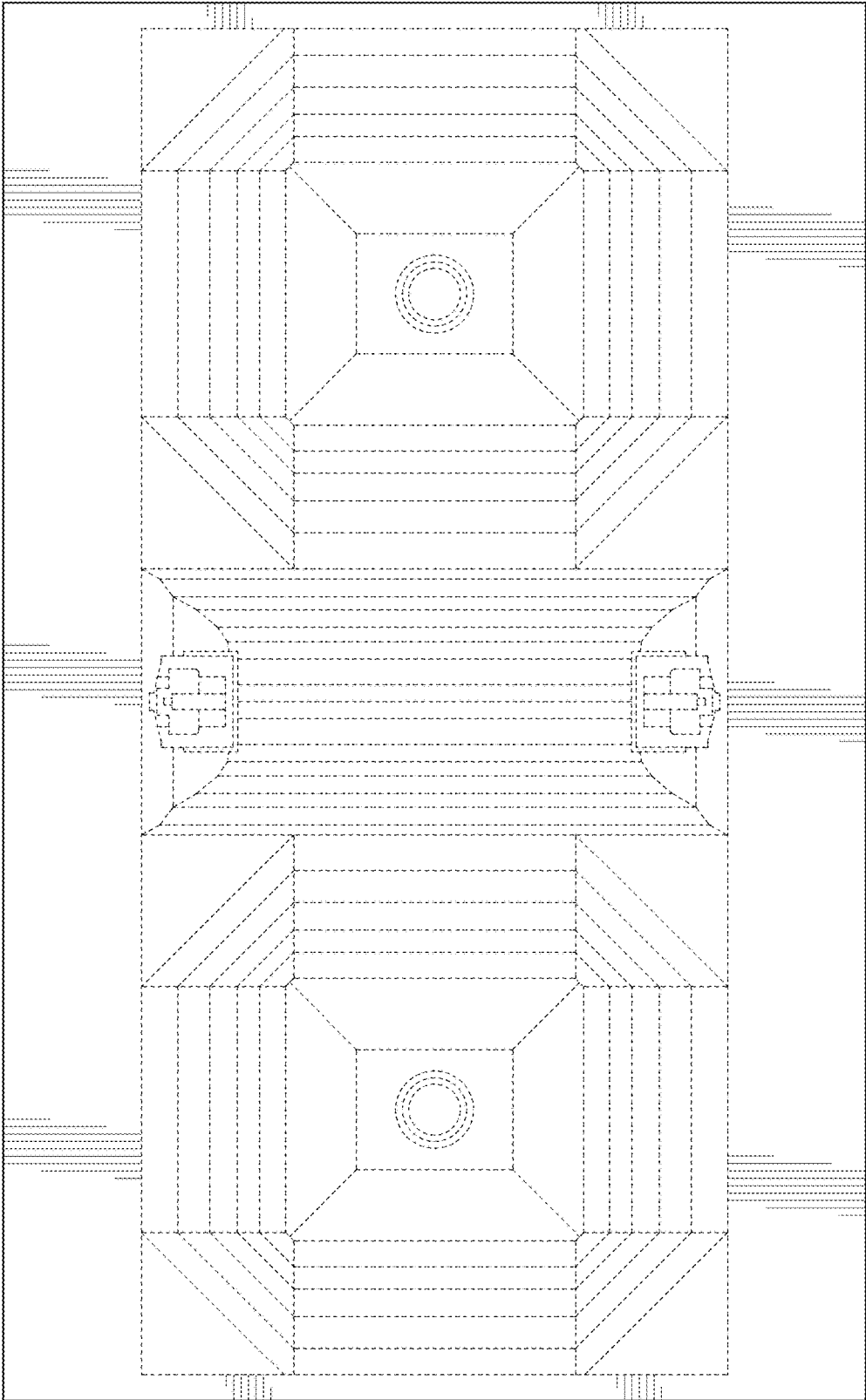

FIG. 7

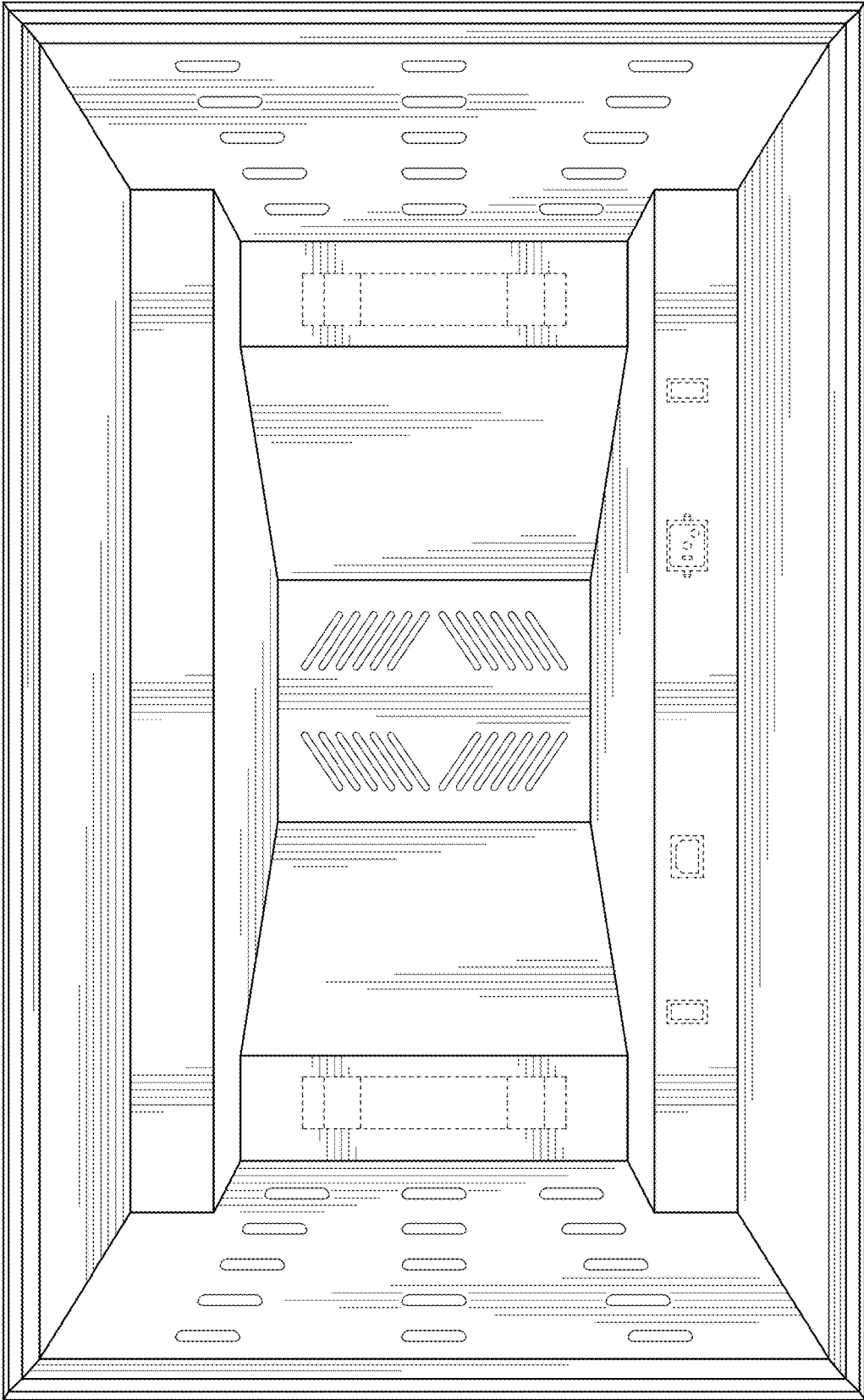

FIG. 8