

(19) World Intellectual Property Organization  
International Bureau



(43) International Publication Date  
30 October 2003 (30.10.2003)

PCT

(10) International Publication Number  
WO 03/090199 A1

(51) International Patent Classification<sup>7</sup>: G09G 5/00,  
1/16, 3/20

(21) International Application Number: PCT/IB03/01563

(22) International Filing Date: 16 April 2003 (16.04.2003)

(25) Filing Language: English

(26) Publication Language: English

(30) Priority Data:  
02076545.9 19 April 2002 (19.04.2002) EP

(71) Applicant (for all designated States except US): KONINKLIJKE PHILIPS ELECTRONICS N.V. [NL/NL]; Groenewoudseweg 1, NL-5621 BA Eindhoven (NL).

(72) Inventor; and

(75) Inventor/Applicant (for US only): LUK, Kwok, H. [CN/CN]; Prof. Holstlaan 6, NL-5656 AA Eindhoven (NL).

(74) Agent: RAAP, Adriaan, Y.; Internationaal Octrooibureau B.V., Prof. Holstlaan 6, NL-5656 AA Eindhoven (NL).

(81) Designated States (national): AE, AG, AL, AM, AT, AU, AZ, BA, BB, BG, BR, BY, BZ, CA, CH, CN, CO, CR, CU, CZ, DE, DK, DM, DZ, EC, EE, ES, FI, GB, GD, GE, GH, GM, HR, HU, ID, IL, IN, IS, JP, KE, KG, KP, KR, KZ, LC, LK, LR, LS, LT, LU, LV, MA, MD, MG, MK, MN, MW, MX, MZ, NI, NO, NZ, OM, PH, PL, PT, RO, RU, SC, SD, SE, SG, SK, SL, TJ, TM, TN, TR, TT, TZ, UA, UG, US, UZ, VC, VN, YU, ZA, ZM, ZW.

(84) Designated States (regional): ARIPO patent (GH, GM, KE, LS, MW, MZ, SD, SL, SZ, TZ, UG, ZM, ZW), Eurasian patent (AM, AZ, BY, KG, KZ, MD, RU, TJ, TM), European patent (AT, BE, BG, CH, CY, CZ, DE, DK, EE, ES, FI, FR, GB, GR, HU, IE, IT, LU, MC, NL, PT, RO, SE, SI, SK, TR), OAPI patent (BF, BJ, CF, CG, CI, CM, GA, GN, GQ, GW, ML, MR, NE, SN, TD, TG).

**Published:**

- with international search report
- before the expiration of the time limit for amending the claims and to be republished in the event of receipt of amendments

For two-letter codes and other abbreviations, refer to the "Guidance Notes on Codes and Abbreviations" appearing at the beginning of each regular issue of the PCT Gazette.

(54) Title: PROGRAMMABLE DRIVERS FOR DISPLAY DEVICES

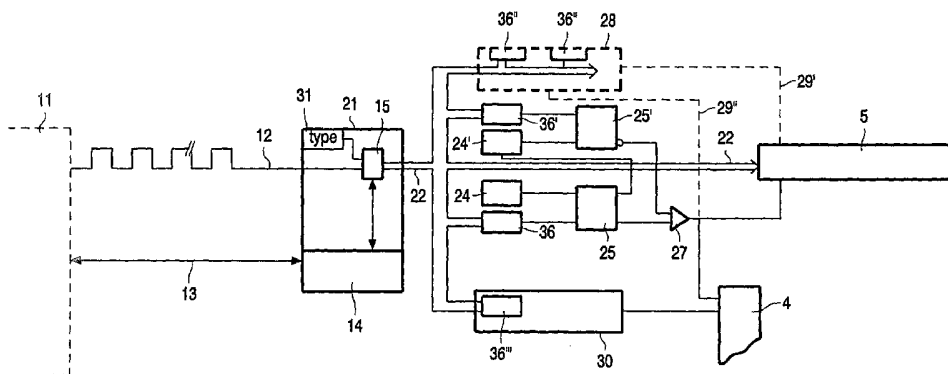

(57) Abstract: A display device (panel) is made recognizable by an application (11) in an electronic apparatus. This enables the application to use otherwise dummy lines (L1... L22) during start up to be used to program configuration parameters (parameters like display length and width, TFT-driving parameters like pulse widths etc.)

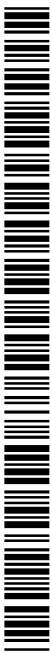

WO 03/090199 A1

## PROGRAMMABLE DRIVERS FOR DISPLAY DEVICES

The invention relates to an electronic apparatus suitable for displaying information via a display device, the display device having a display panel provided with driving electronics.

The invention furthermore relates to a method for programming a controller  
5 for a display device for at least one application and to a display device.

The display device may belong to one of the groups of liquid crystal display devices, electrochromic display devices, electrophoretic display devices, reflective display devices including an interferometric modulator and luminescent display devices. Examples of such active matrix display devices are TFT-LCDs or AM-LCDs, which are used in laptop  
10 computers and in organizers, but also find an increasingly wider application in GSM telephones.

Such matrix displays are generally addressed by means of selection lines  
15 which periodically address (a group of) selection lines or rows, via switches such as TFT (MOS) -transistors, while at the main time data (voltages) are provided via (a group of) data lines or columns.

The liquid crystal display device (LCD) is usually a self-contained module, with associated electronics, which is built into a module. The interface signal between the  
20 module and the electronic apparatus application is usually a standard one. It generally comprises at least the following signals:

- a vertical synchronization pulse (the signal that aligns the display information within a frame)
- a horizontal synchronization pulse (the signal that aligns the display  
25 information within a line)
- pixel clock signals (the clock that aligns the display information with the pixel)
- RGB digital display data. Depending on the number of colors for the display, this can be a data bus of width 12 (4 bit/color) to 24 bits (8 bits/color)

One problem associated with these kind of interfaces is the fact that a certain liquid crystal display device, which the display manufacturer preferably manufactures in large volume does not within the electronic apparatus, automatically fit to a certain application in said apparatus. It may for instance occur that within a number of different applications 220, 240 and 260 rows may be used while the number of columns varies between 150 and 180 dependent on the application. This implies that in some applications a number of lines and /or columns should remain idle.

The associated electronics of the display device comprise driver circuits like row drivers and column drivers. In active matrix liquid crystal display devices (AMLCD panels) these row drivers and column drivers are connected to gates and sources of thin film transistors (TFTs). The drivers generally are driven by some dedicated control signals. As a result, some kind of "controller" is required on the module to generate these signals from the input synchronization pulses and pixel clock. Such controller is generally realized with an application-specific integrated circuit (ASIC).

A main problem is the fact that the number of lines and columns within liquid crystal display devices manufactured in large volume does not correspond to the number of lines and columns within electronic apparatuses related to different applications. This implies that the control signals, associated with a number of timing parameters, need to be changed from one display device (AMLCD panel) to another. For instance, when the number of lines and columns within the display application of the LCD panel is different from one application to another, parameters and hence control signals have to be modified. In this case a new ASIC needs to be made for every application, leading to extra initial costs and inventory control. A number of possible alternatives can be thought of e.g.

- incorporating nonvolatile memory to store such parameters. The memory is pre-programmed in the factory. This adds per-unit cost of the device
- use of input pins connection to select between different applications. This makes the device only usable for those specific applications and hence is not flexible enough
- use of a single metal mask for configuring the parameters. This lowers the initial cost and lead-time but does not overcome the inventory problem.

It is one of the objects of the invention to overcome at least partly the above mentioned problem. To this end an electronic apparatus according to the invention comprises a controller for selecting at least one application for the display device and further comprises

memory means for storing display parameters related to said application and means for providing said display parameters to an interface between the electronic apparatus and the display device, the display parameters belonging to the group of number comprising the number of lines to be displayed, the number of columns to be displayed, parameters related to driving transistors or power saving parameters.

The invention is based on the insight that for almost all applications, the number of lines (and columns) as used in the application is less than the number of lines (and columns) within the display device. As a result, there will always be a time slot (some line times e.g. immediately after the first vertical pulse) to accommodate a number of dummy line times at the beginning of every frame. Within these dummy line times, the (RGB) data bus does not usually carry any meaningful information and therefore may be exploited to program panel-specific timing parameters as mentioned above into the "controller" (the ASIC). The controller preferably is designed to recognize a special, pre-defined bit pattern in the (RGB) data bus of the first few dummy lines. If such special pattern does not exist, the rest of the dummy lines will remain "dummy" and be ignored. If the pattern is identified, the (RGB) data in the following dummy lines will be timing parameters. The advantages with this approach are

- no dedicated interface is required for the programming of those timing parameters and other parameters. This means minimum impact to the host application
- no extra pin is required on the controller integrated circuit. This is important for space-critical applications, e.g. hand-held devices
- the bit pattern chosen can be made transparent to customers who do not want such a feature.

These and other aspects of the invention are apparent from and will be elucidated with reference to the embodiments described hereinafter.

In the drawings:

Figure 1 shows the use of different sizes of display devices in different applications

Figure 2 is an electrical equivalent of a possible embodiment of such a display device, while

Figure 3 is an electrical equivalent of a part of the display device according to the prior art and,

Figure 4 is an electrical equivalent of a part of the display device according to the invention.

The Figures are diagrammatic and not drawn to scale. Corresponding elements are generally denoted by the same reference numerals.

5

Figure 1 shows how the size of the actual display panel may vary, dependent on the kind of application. In Figure 1<sup>a</sup> one typical example is given viz. the use of displays in mobile telephones. A typical display device (panel) 1 in these applications has dimensions of about 2 cm x 4 cm, whereas the number of lines may vary between 50 and 100 while the number of columns may vary between 100 and 200. In Figure 1<sup>b</sup> another example is given viz. the use of displays in portable computers. A typical display device (panel) in these applications has dimensions of about 20 cm x 30 cm, whereas the number of lines may vary between 250 and 300 while the number of columns may vary between 200 and 400.

Figure 2 is an electric equivalent circuit diagram of a part of a display device 1 to which the invention is applicable. It comprises in one possible embodiment (one mode of driving, called the "passive mode") a matrix of pixels 8 defined by the areas of crossings of row or selection electrodes 7 and column or data electrodes 6. The row electrodes are consecutively selected by means of a row driver 4, while the column electrodes are provided with data via a data register 5. To this end, incoming data 2 are first processed, if necessary, in a processor 3. Mutual synchronization between the row driver 4 and the data register 5 takes place via drive lines 9.

In another possible embodiment (another mode of driving, called the "active mode"), shown in detail for one crossing one pixel only, signals from the row driver 4 select the picture electrodes via thin-film transistors (TFTs) 10 whose gate electrodes are electrically connected to the row electrodes 7 and the source electrodes are electrically connected to the column electrodes 6. The signal that is present at the column electrode 6 is transferred via the TFT 10 to a picture electrode of a pixel 8 coupled to the drain electrode. The other picture electrodes are connected to, for example, one (or more) common counter electrode(s). In Figure 2 only one thin-film transistor (TFTs) 10 has been drawn, simply as an example.

Input data to the driver 3, comprising data signals 12, and timing and synchronizing signals 13 are available from a processor 11, whose function and architecture is dependent on the kind of application to which the display device is assigned (e.g. a mobile

phone processor or a computer processor). Said signals, together with a part of the driver 3 are shown in Figure 3 for a part of a display device according to the prior art. For the clarity of explanation it is supposed that the available number of rows for the actual display device (panel) is 240 and that the available number of columns is 200.

5           The application as designed in the processor 11 however, in this example supplies 270 line selection times within one frame time  $t_f$ . This implies that a number of rows should not be provided with data signals 12 (in this example the first 22 rows L1, L2, ... L22 during interval  $T_{vds}$  and the last 8 rows L263, L264, ... L270 of the display device (panel), as shown in Figure 3 (b)). Also it could be necessary that during selection of a row a number  
10 of columns should have a defined value or not be activated at all in this example.

          In the prior art device of Figure 3(a) data signals 12, and timing and synchronizing signals 13 are processed (schematically shown by boxes 14, 15 and double-arrow 16 in a part 21 of driver 3) to generate a data stream 22 and timing signals 23 of a first frequency as well as timing signals 24 of a second frequency. The synchronizing signals and  
15 timing signals are derived from a (not shown) system clock signal. Signals 23 at time  $t_0$  start a counting circuit 24. The content of counting circuit 24 is compared in comparator 25 to a fixed value (in this example 22) stored in e.g. a ROM- circuit 26. As soon as the content of counting circuit 24 reaches 22 (at time  $t_1$ ) the outputs of comparator 25 are activated. One of the outputs in this example, via line 38 starts a second counting circuit 24'. The content of  
20 counting circuit 24' is compared in comparator 25' to another fixed value (in this example 240) stored in e.g. another ROM- circuit 26' (or part of the same ROM- circuit 26). It will be clear that it is also possible to delete line 26 and use 262 as the other fixed value stored in ROM- circuit 26'.

          In the present example however the row driver 4 and the data register 5 have  
25 to be enabled during the period  $t_1 - t_2$  (i.e. during lines L23, L24, ... L262, time period  $T_{vdp}$  in Figure 3 (b)), which is accomplished by the AND function 27 of the output of comparator 25 and the inverse output of comparator 25'. For simplicity and since this is not a part of the invention further functional circuitry in the driver 3 to ensure certain delays and resetting of counters etcetera is not shown in Figure 3 (a). The same holds for synchronizing and/or other  
30 timing circuitry (e.g. in part 21).

          If necessary, in a similar way the enabling of a number of columns can be set to a defined value by schematically shown circuit 28, having one or more ROM- circuit 26'' and counters 24'' and dashed synchronizing and control lines 23'', 29''.

Also in a similar way timing signals 24 may be counted in circuit 30 (having one or more ROM- circuit 26''''and counters 24'''), in which multiple of e.g. a clock period may be determined to set values for parameters used to drive the row driver 4, such as

a) Gate select width – during operation, the row driver 4 supplies selection pulses within each row to the TFTs 10 to turn the TFTs on and apply the appropriate voltages to the pixels. The duration of such an electrical pulse depends on some physical characteristics of the display device (panel) as well as the row driver 4 being used.

b) Gate enable width – the selection pulse as mentioned above may need to be suppressed within a short time period to avoid selection pulses for two consecutive rows from overlapping each other, which causes cross-talk. The duration of such enable signal will also be specific for the display device (panel).

c) PS pulse width and location –Some pixels or even columns may not be needed to be driven within the whole frame period  $t_f$ . A so-called power-saving pulse (PS – pulse) is supplied to the source LCD driver to put its outputs into the so-called “high-impedance” state (a state that does not deliver any electrical current) within the time period of PS- pulse. Power consumption is therefore reduced in this way. The duration and location of said pulse will again be specific for the display device (panel).

In the embodiment of Figure 3 all parameters described are programmed in advance by programming a certain value into one or more ROM- circuit 26. Since these parameters in general all are specific for the particular application or the display device (panel) this programming has to be done for each new product (and also if a display device (panel) has to be manufactured in a different production line e.g. due to second source requirements).

Said problems have been overcome in the device according to the invention as shown in Figure 4. The construction of this device is practically similar to the embodiment of Figure 3, so the same reference numerals have been used. According to the invention however the ROM- circuits 26 have been replaced by e. g. random access memories 36 or registers, whereas the data 22 (shown here as a bus structure) is supplied to all said random access memories 36. Moreover the box (controller) 21 comprises an identification circuit 31 (e.g. a ROM –circuit) which is specific for the display device (panel).

The application as designed in the processor 11 now however during a number of lines (in this example only the first line L1) of interval  $T_{vds}$  provides the driver 3 with application specific parameters and/or panel specific parameter blocks 41-49.

These parameter blocks are provided in a specific sequence, which enables the random access memories 36 to be loaded in the same specific sequence. The sequence itself could be standardized in a protocol to be agreed upon by buyers (application designers) and manufacturers of display devices (panels).

5           Parameter (data) block 41 for example is a special bit pattern to be recognised by the controller (box) 21. In most applications, up till now the data bus is held at 0 within the first (dummy) lines and so any arbitrary pattern can serve as the special bit pattern. If there is a pattern match, the data in the subsequent parameter (data) blocks 42- 9 are interpreted as the parameters mentioned above. If such special pattern does not exist, the rest  
10 of the dummy lines will remain “dummy” and be ignored.

Said parameters will then be loaded into the random access memories 36 in the pre-defined sequence as described above. The following is a brief explanation of some parameters:

Block 42 and block 43: display length and display width – they define  
15 respectively the display’s number of lines and the number of pixels within a line. They should be 240 in the example described above and e.g. 160.

Block 44: number of dummy lines at the beginning of a frame as mentioned above (22 in the example described above).

Block 45: number of dummy pixels inserted at the beginning of each line  
20 before the first actual pixel data.

Blocks 46, 47, 48 and block 49 may define gate select width, gate enable width and PS pulse width and location respectively as described above for the embodiment of Figure 3.

Blocks 47 and 48 for example may refer to different lengths of a pulse width  
25 dependent on the kind of manufacturing. For example in a display device (panel) from one manufacturer the gate select should at least be 5 clock pulse, whereas in a display device (panel) from another manufacturer the gate select should at least be 6 clock pulse (e.g. due to some slight differences in manufacturing technology). This implies that the corresponding random access memories 36, related to timing parameters for TFTs 10, as set in block 46 may  
30 differ from one manufacturer to another. This determines different values for the identification circuit 3, dependent on the process used. Since the programming of the random access memories 36 is now part of the application (processor 11) some extra memory is needed in the application (processor 11). This however is negligible with respect to the total memory.



It will be clear that such a display device (panel) which is dynamically programmable can easily be adopted to many different applications leading to lower costs, while in most cases off the shelf display devices (panels) can be used.

5 The protective scope of the invention is not limited to the embodiments described, while the invention is also applicable to other display devices, for example, (O) LED displays, and other display devices in which parameters may change dependent on the application.

10 While in the example all blocks 41–49 are provided during one line only (the first line L1) of interval Tvds, it will be clear that said parameters can be provided during a number of lines of interval Tvds.

On the other hand the electronic apparatus comprising the display device (panel) may be suited for different applications (e.g. both a telephone application and a calculator application) which each have different parameters (number of lines, number of columns).

15 The invention resides in each and every novel characteristic feature and each and every combination of characteristic features. Reference numerals in the claims do not limit their protective scope. Use of the verb “to comprise” and its conjugations does not exclude the presence of elements other than those stated in the claims. Use of the article "a" or "an" preceding an element does not exclude the presence of a plurality of such elements.

20

## CLAIMS:

1. An electronic apparatus suitable for displaying information via a display device, the display device having a display panel provided with driving electronics, the electronic apparatus comprising a controller for selecting at least one application for the display device and further comprising memory means for storing at least display parameters  
5 related to said application and means for providing said display parameters to an interface between the electronic apparatus and the display device, the display parameters belonging to the group of number comprising the number of lines to be displayed, the number of columns to be displayed, parameters related to driving transistors or power saving parameters.
- 10 2. An electronic apparatus according to claim 1 in which the electronic apparatus further comprises memory means for storing parameters related to the selection of driving transistors.
3. A method for programming a controller for a display device for at least one  
15 application for the display device comprising memory means for storing display parameters related to said application the method comprising the steps of programming into said memory means at least one of the parameters:
- a) the number of lines to be displayed
  - b) the number of columns to be displayed
- 20 4. A method according to claim 3 the method further comprising the steps of programming into said memory means at least one of the parameters
- c) parameters related to the selection of driving transistors
  - d) power saving parameters
- 25 5. A method according to claim 3 or 4 in which the programming into the memory of the display parameters related to said application is related to a sequence of providing said display parameters to an interface between the electronic apparatus and the display device.

6. A display device for use in an electronic apparatus according to claim 1, the display device having a display panel provided with driving electronics and means for recognizing an identification code at an interface between the electronic apparatus and the display device.

7. A display device according to claim 6 the driving electronics further comprising means for storing in storage means a sequence of parameters controlling the panel.

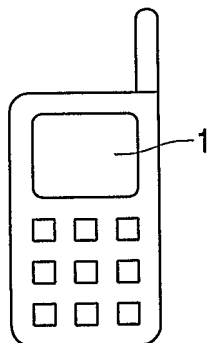

FIG. 1a

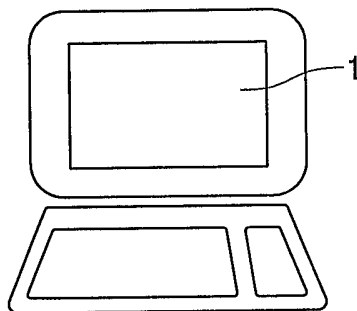

FIG. 1b

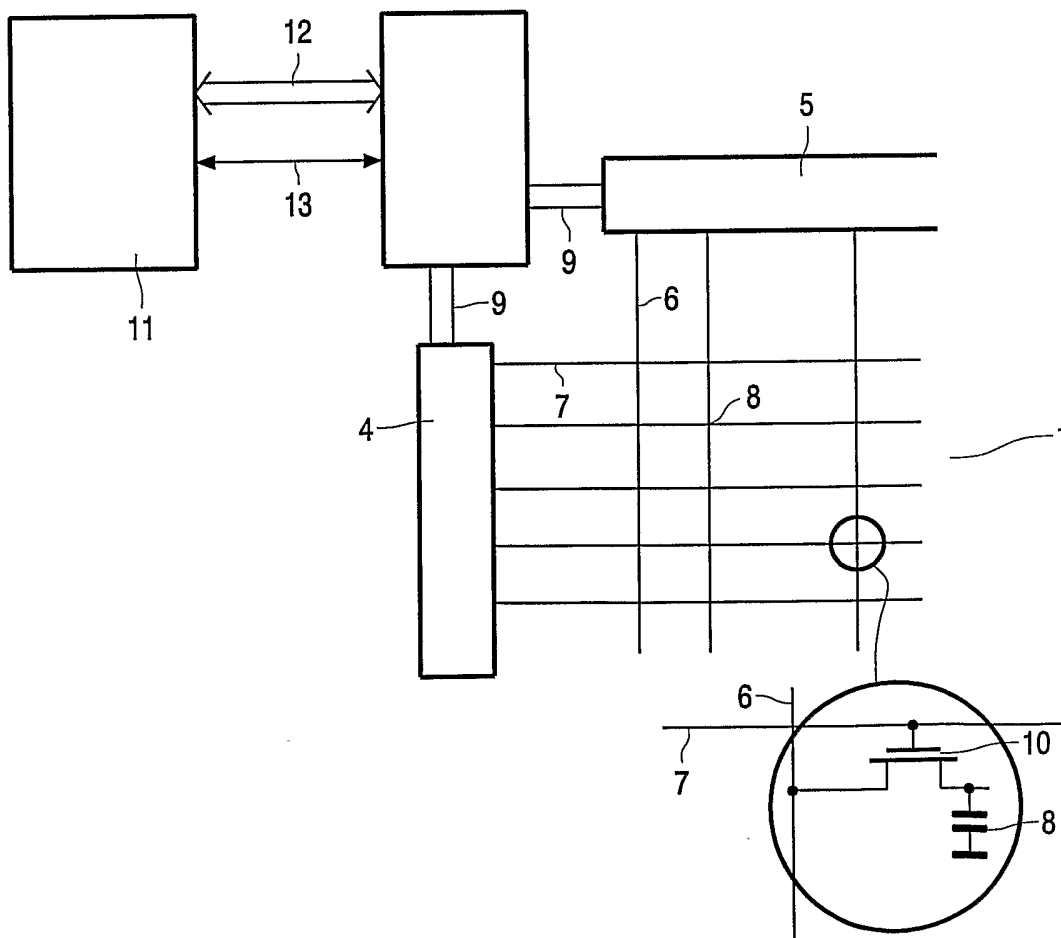

FIG. 2

2/5

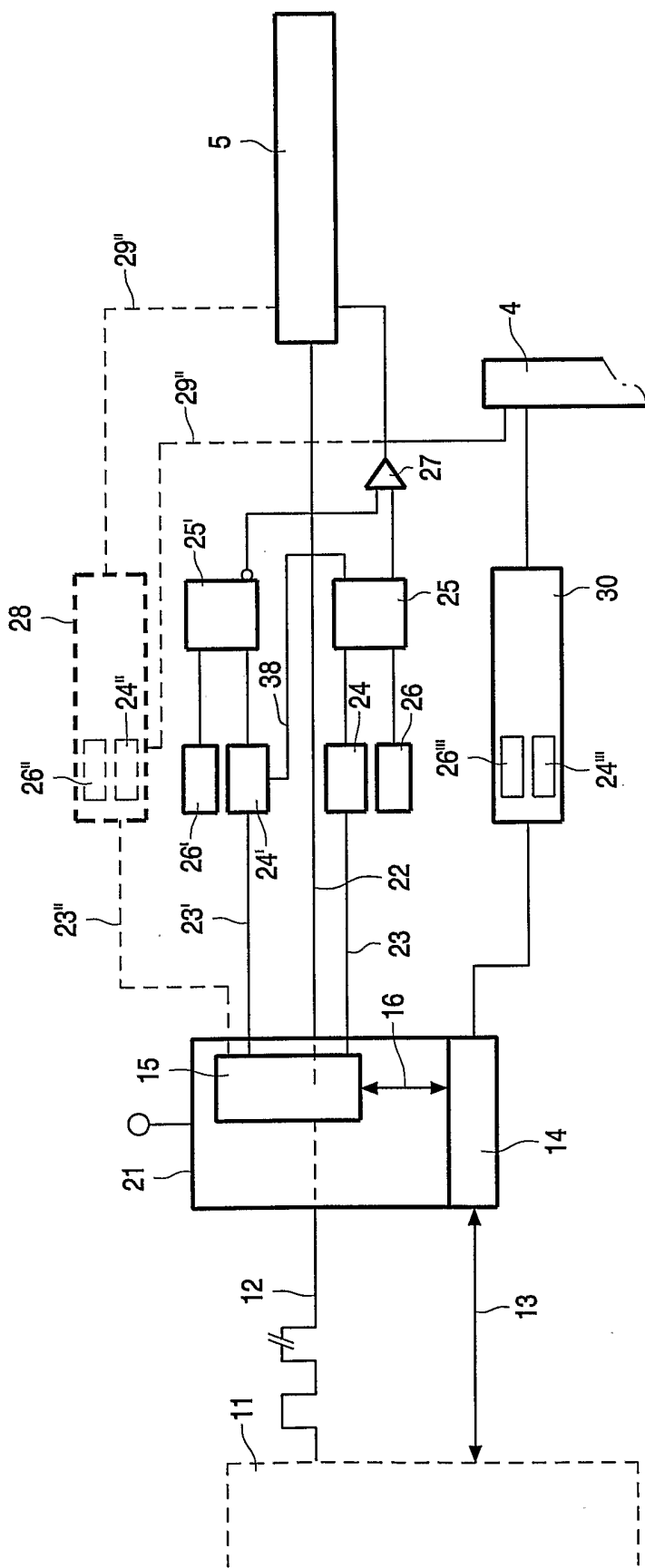

FIG. 3a

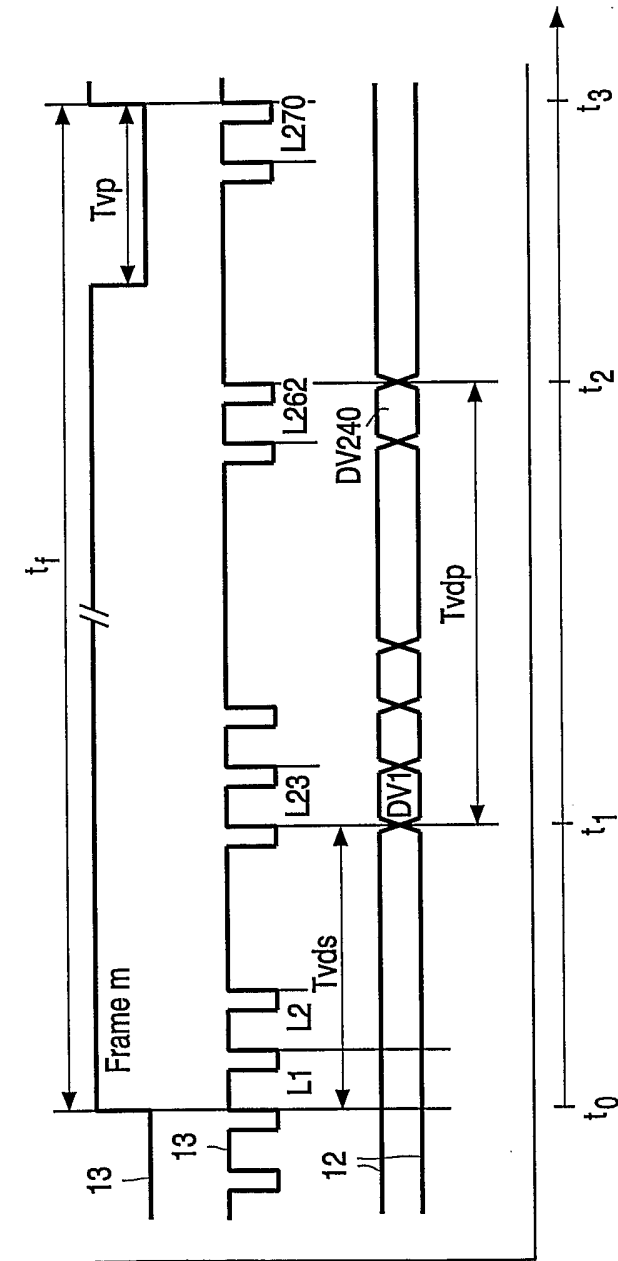

FIG. 3b

4/5

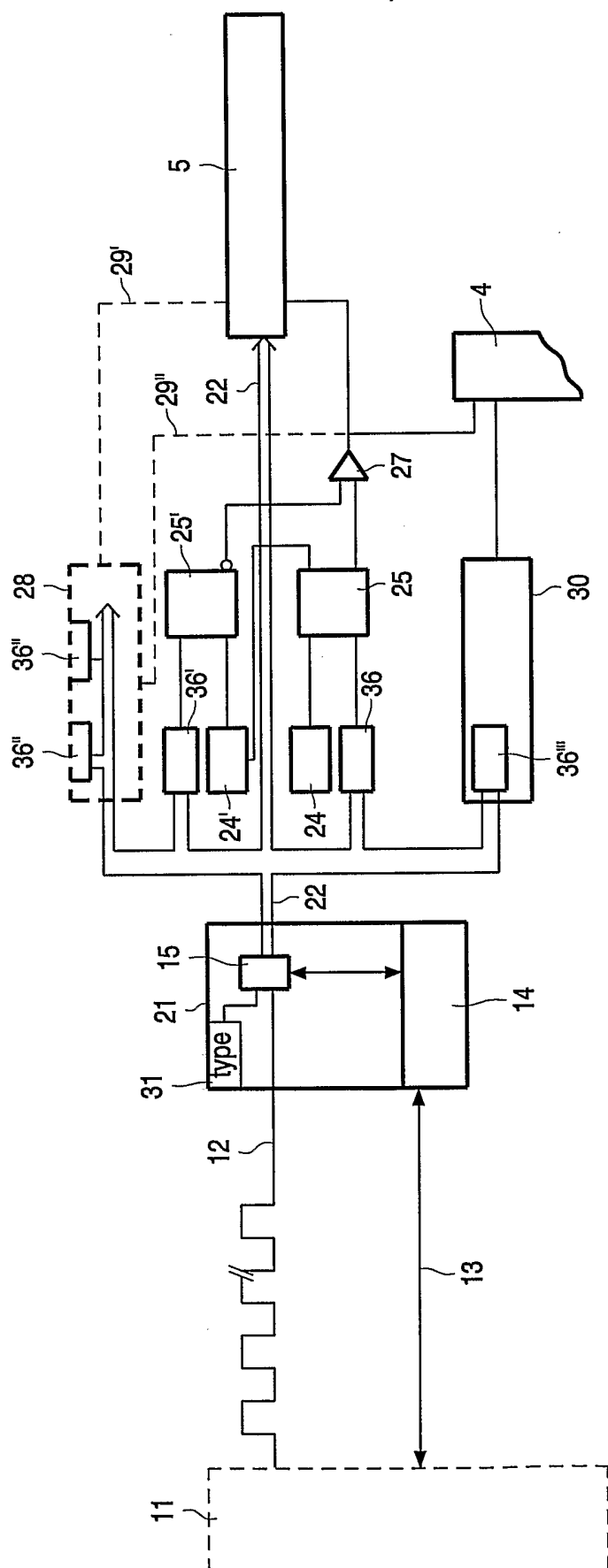

FIG. 4a

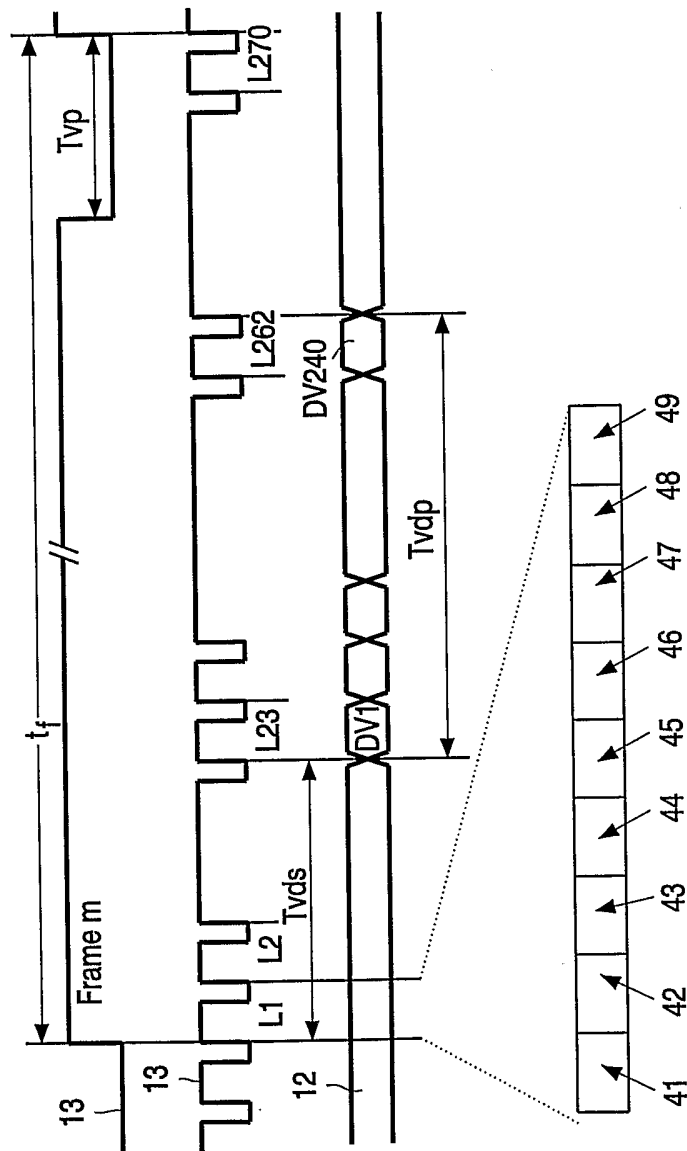

FIG. 4b



INTERNATIONAL SEARCH REPORT

International Application No

PCT/IB 03/01563

<b>A. CLASSIFICATION OF SUBJECT MATTER</b> IPC 7 G09G5/00 G09G1/16 G09G3/20		
According to International Patent Classification (IPC) or to both national classification and IPC		
<b>B. FIELDS SEARCHED</b> Minimum documentation searched (classification system followed by classification symbols) IPC 7 G09G		
Documentation searched other than minimum documentation to the extent that such documents are included in the fields searched		
Electronic data base consulted during the international search (name of data base and, where practical, search terms used) EPO-Internal, PAJ, WPI Data		
<b>C. DOCUMENTS CONSIDERED TO BE RELEVANT</b>		
Category <sup>o</sup>	Citation of document, with indication, where appropriate, of the relevant passages	Relevant to claim No.
X	EP 1 111 572 A (EIZO NANA O CORP) 27 June 2001 (2001-06-27) abstract paragraph '0008! - paragraph '0010!; figure 1 paragraph '0012! - paragraph '0014! paragraph '0022! - paragraph '0025! paragraph '0028! - paragraph '0029! paragraph '0046! claim 1 ---	1-7
X	PATENT ABSTRACTS OF JAPAN vol. 1999, no. 13, 30 November 1999 (1999-11-30) & JP 11 231994 A (TOSHIBA CORP), 27 August 1999 (1999-08-27) abstract --- -/--	1-7
<input checked="" type="checkbox"/> Further documents are listed in the continuation of box C.		
<input checked="" type="checkbox"/> Patent family members are listed in annex.		
<sup>o</sup> Special categories of cited documents:		
*A* document defining the general state of the art which is not considered to be of particular relevance *E* earlier document but published on or after the international filing date *L* document which may throw doubts on priority claim(s) or which is cited to establish the publication date of another citation or other special reason (as specified) *O* document referring to an oral disclosure, use, exhibition or other means *P* document published prior to the international filing date but later than the priority date claimed		*T* later document published after the international filing date or priority date and not in conflict with the application but cited to understand the principle or theory underlying the invention *X* document of particular relevance; the claimed invention cannot be considered novel or cannot be considered to involve an inventive step when the document is taken alone *Y* document of particular relevance; the claimed invention cannot be considered to involve an inventive step when the document is combined with one or more other such documents, such combination being obvious to a person skilled in the art. *&* document member of the same patent family
Date of the actual completion of the international search 1 October 2003		Date of mailing of the international search report 10/10/2003
Name and mailing address of the ISA European Patent Office, P.B. 5818 Patentlaan 2 NL - 2280 HV Rijswijk Tel. (+31-70) 340-2040, Tx. 31 651 epo nl, Fax: (+31-70) 340-3016		Authorized officer Wolff, L

2

INTERNATIONAL SEARCH REPORT

International Application No  
PCT/IB 03/01563

C.(Continuation) DOCUMENTS CONSIDERED TO BE RELEVANT		
Category °	Citation of document, with indication, where appropriate, of the relevant passages	Relevant to claim No.
X	PATENT ABSTRACTS OF JAPAN vol. 2000, no. 10, 17 November 2000 (2000-11-17) & JP 2000 194346 A (NEC HOME ELECTRONICS LTD), 14 July 2000 (2000-07-14) abstract -----	1-7
A	US 5 522 027 A (ANDO MOTOAKI ET AL) 28 May 1996 (1996-05-28) abstract column 1, line 14 - line 18 column 2, line 66 -column 3, line 52 column 8, line 43 -column 9, line 12 -----	1-7

## INTERNATIONAL SEARCH REPORT

 International Application No  
 PCT/IB 03/01563

Patent document cited in search report		Publication date	Patent family member(s)	Publication date
EP 1111572	A	27-06-2001	JP 2001175230 A	29-06-2001
			EP 1111572 A2	27-06-2001
			US 2001004257 A1	21-06-2001
-----				
JP 11231994	A	27-08-1999	NONE	
-----				
JP 2000194346	A	14-07-2000	NONE	
-----				
US 5522027	A	28-05-1996	US 5438663 A	01-08-1995
			US 5675750 A	07-10-1997
			DE 69312786 D1	11-09-1997
			DE 69312786 T2	05-03-1998
			EP 0568078 A1	03-11-1993
			JP 2760731 B2	04-06-1998
			JP 6059856 A	04-03-1994
-----				