



(10) **SE 1551274 A1**

Sweden

Sweden

(12) **Public patent application (international application which has entered national phase)**

(21) Application number: 1551274-2

(22) Filing date: 2014-03-12

(24) Effective date: 2014-03-12

(41) Available to the public: 2015-10-05

(43) Publication date: 2015-10-27

(51) Int. Cl: **F02D 41/30** (2006.01)
F02M 65/00 (2006.01)
G01M 15/05 (2006.01)
F02M 7/00 (2006.01)

(71) Applicant: Walbro Engine Management, L.L.C., 7400 North Oracle Road, Suite 310, AZ 85704 Tucson, US

(72) Inventor: Martin, N. Andersson, Caro, US
Mark, S. Swanson, Cass City, US

(74) Agent: AWAPATENT AB, Box 1066, 251 10 HELSINGBORG, SE

(30) Priority data: 2013-03-15 US 61/794,389

(54) Title: Engine control strategy and feedback system

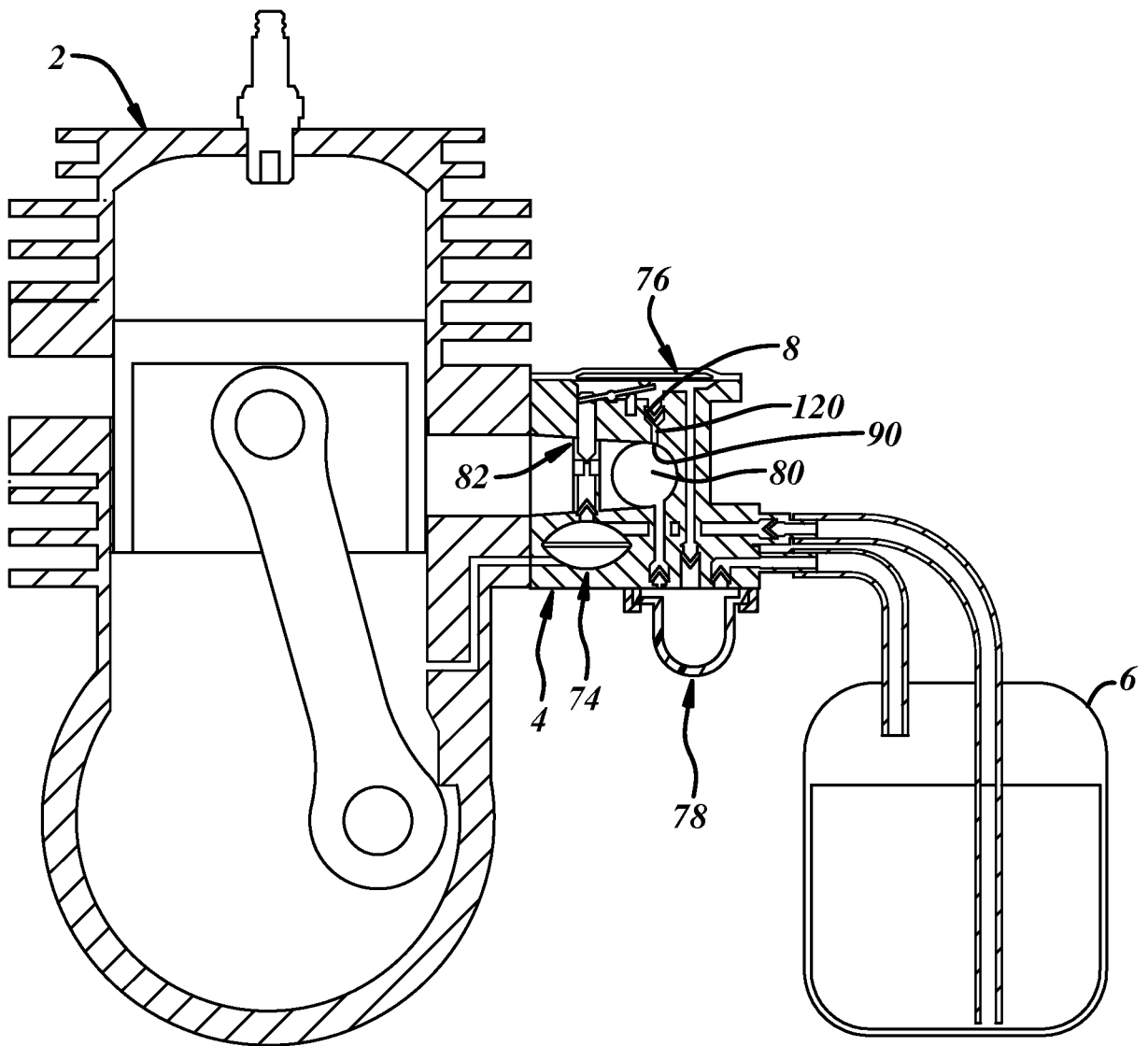

FIG. 1

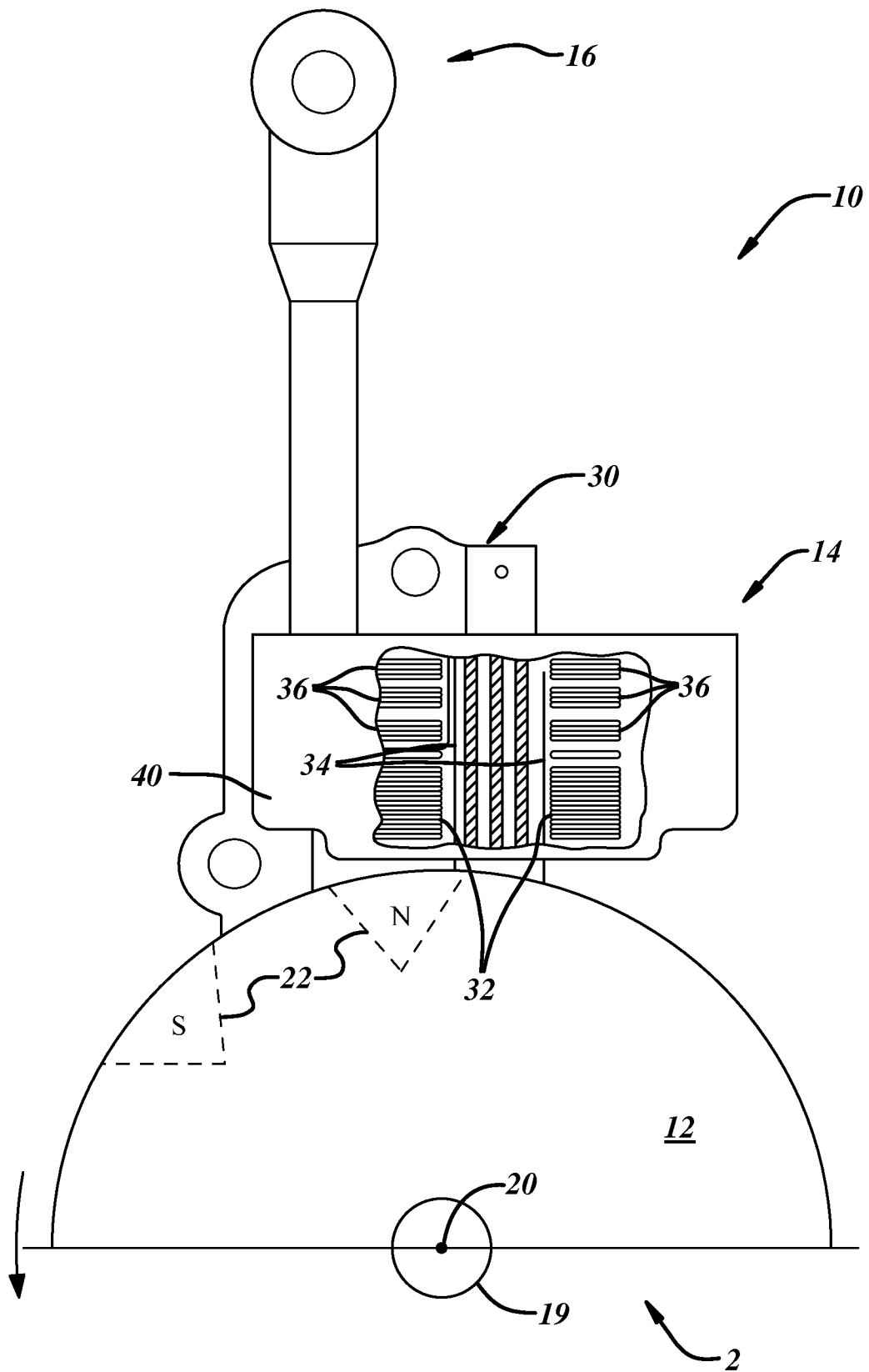

FIG. 2

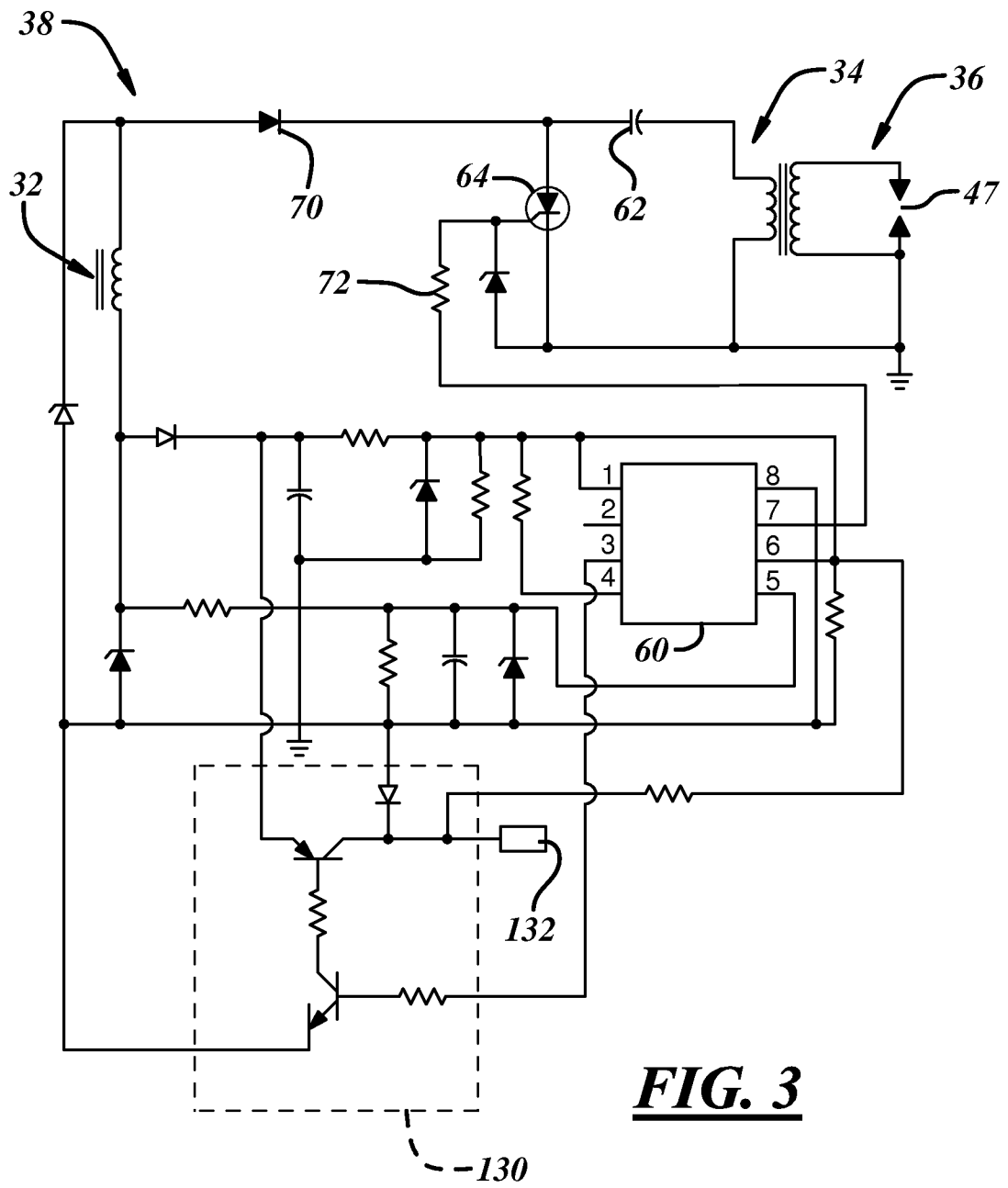

FIG. 3

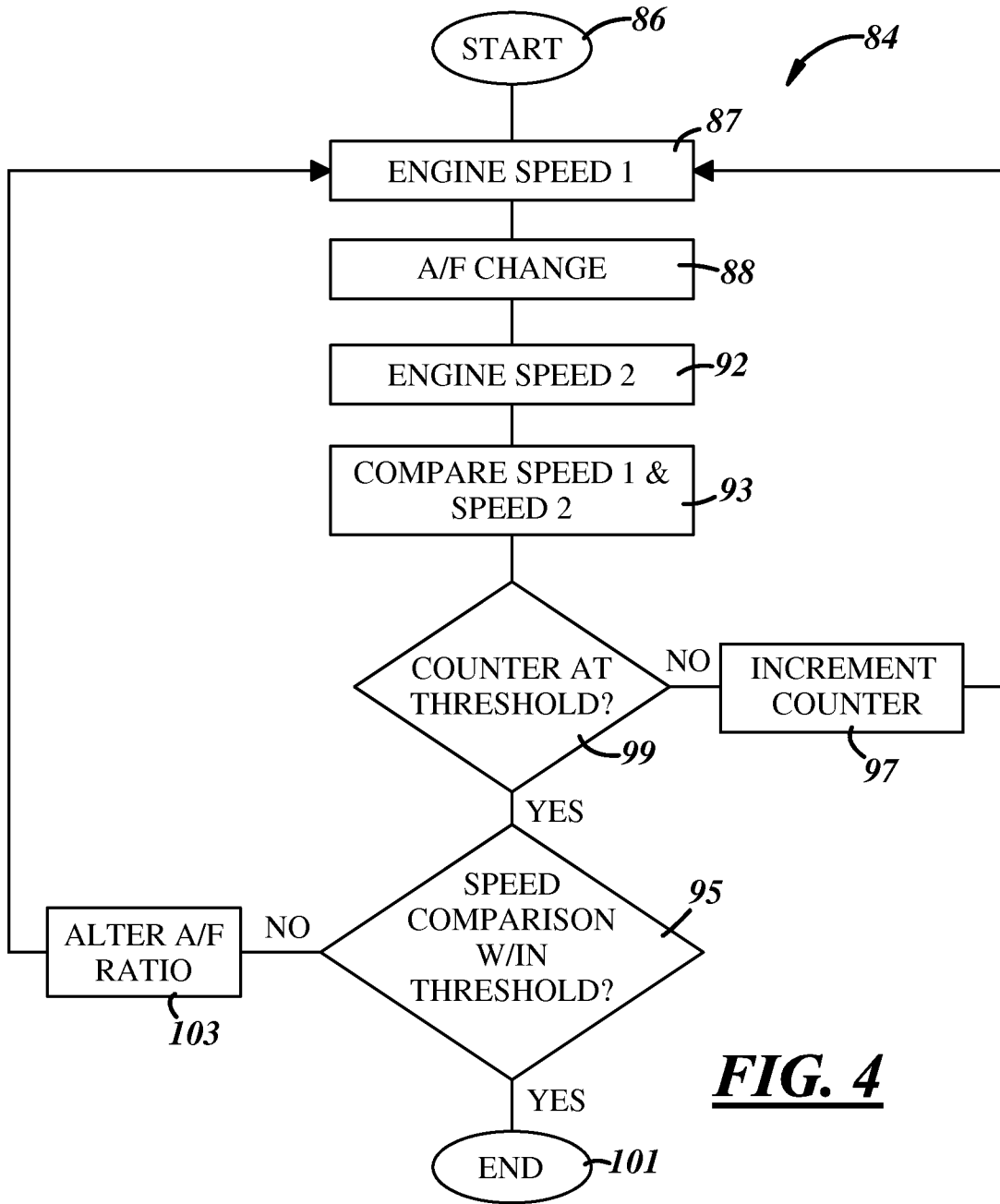

FIG. 4

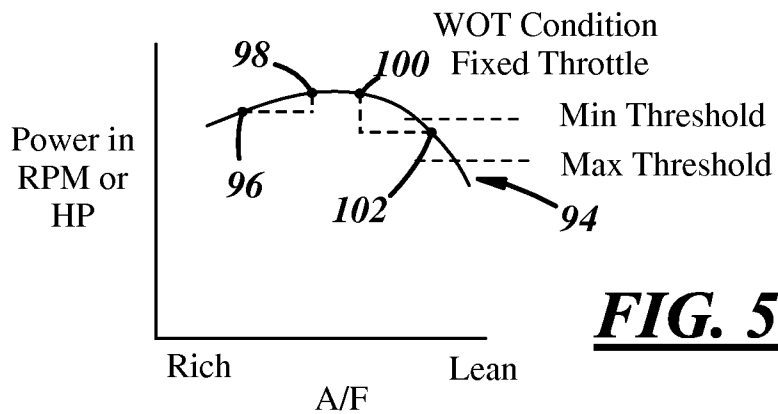

FIG. 5

Test 50 Degree Lean 20 Revs Lambda 0.81 Start

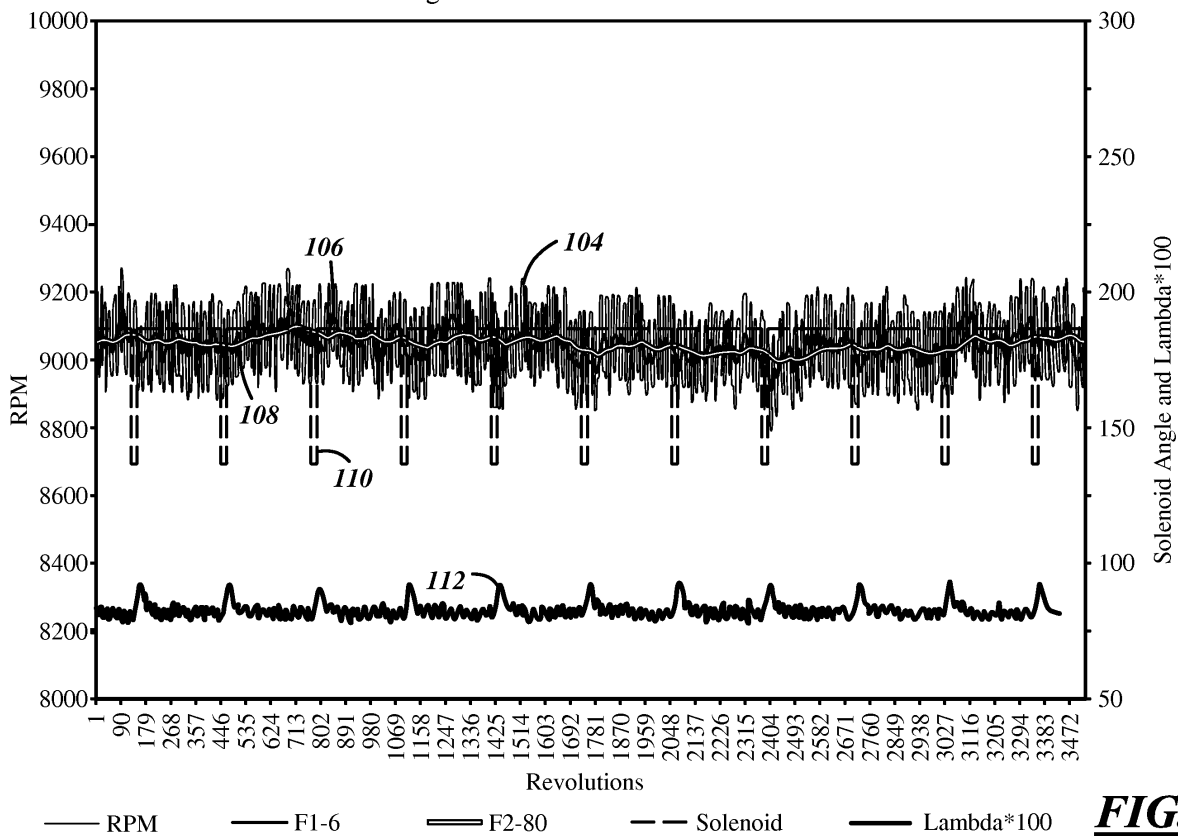

FIG. 6

Test 50 Degree Lean 20 Revs Lambda 0.876 Start

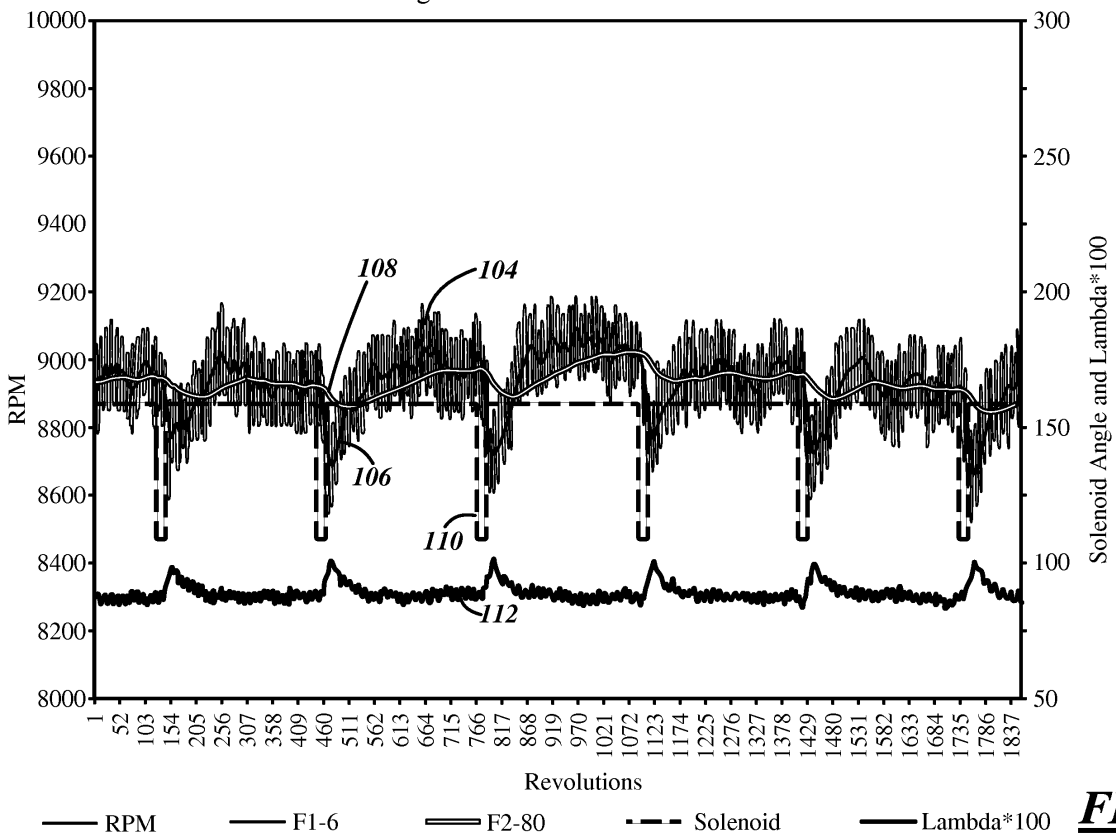

FIG. 7

Automatic Adjustment Speed Sensing Test

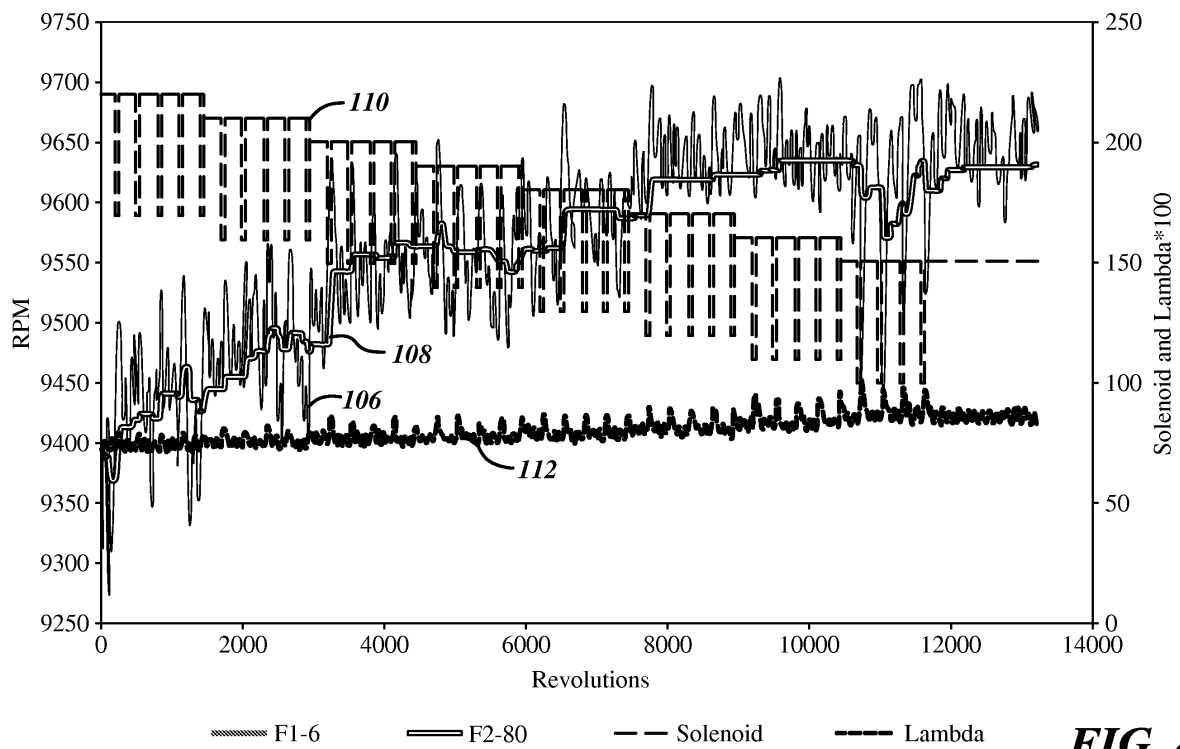

FIG. 8