



(12) **United States Design Patent**
Lu et al.

(10) **Patent No.:** **US D997,422 S**
(45) **Date of Patent:** **** Aug. 29, 2023**

- (54) **TRI-PROOF LAMP**
- (71) Applicant: **Xiamen PVTECH Co., Ltd.**, Fujian (CN)
- (72) Inventors: **Fuxing Lu**, Fujian (CN); **Weibiao Zhong**, Fujian (CN)
- (73) Assignee: **Xiamen PVTECH Co., Ltd.**, Fujian (CN)

D921,271 S *	6/2021	Ghasabi	D26/76
11,071,803 B1 *	7/2021	Lan	F21S 8/06
2012/0162974 A1 *	6/2012	Yu	F21S 4/28
				362/218
2013/0279180 A1 *	10/2013	Pearson	F21V 21/104
				362/373
2016/0356460 A1 *	12/2016	Lu	F21V 23/06
2019/0078769 A1 *	3/2019	Lu	F21V 29/83
2020/0196536 A1 *	6/2020	Pasini	A01G 9/249
2021/0199277 A1 *	7/2021	Lu	F21V 27/02
2022/0128203 A1 *	4/2022	Peng	F21S 9/02
2022/0178506 A1 *	6/2022	Amin	F21V 5/02

(**) Term: **15 Years**

(21) Appl. No.: **29/721,268**

(22) Filed: **Jan. 20, 2020**

(51) **LOC (14) Cl.** **26-05**

(52) **U.S. Cl.**
USPC **D26/76; D26/89**

(58) **Field of Classification Search**
USPC D26/24, 72, 75, 76, 81, 82, 85, 87, 88, D26/89

CPC F21S 8/00; F21S 8/03; F21S 8/033; F21S 8/036; F21S 8/04; F21S 8/043; F21S 8/06; F21S 8/061; F21S 8/063; F21S 8/068; F21S 8/08

See application file for complete search history.

(56) **References Cited**

U.S. PATENT DOCUMENTS

D348,947 S *	7/1994	Holcomb	D26/76
D451,228 S *	11/2001	Poon	D26/76
D452,579 S *	12/2001	Shemitz	D26/76
D521,675 S *	5/2006	Chen	D26/76
D662,245 S *	6/2012	Steffy	D26/75
D671,254 S *	11/2012	Miyatake	D26/75
D697,247 S *	1/2014	Mollaghaffari	D26/76
D793,603 S *	8/2017	Parker	D26/76
D818,626 S *	5/2018	Park	D26/76
D836,815 S *	12/2018	Patterson	D26/76
D850,700 S *	6/2019	Samson	D26/76
D901,751 S *	11/2020	Ye	D26/118

OTHER PUBLICATIONS

2 Foot 20 Watt LED Tri-Proof (available online) Retrieved from the internet Jun. 9, 2023 from URL: <https://www.agcled.com/blog/everything-you-need-to-know-about-led-tri-proof-light-before-you-purchase.html>.*

Triproof Suspension (available online) Retrieved from the internet Jun. 9, 2023 from URL: https://www.lightology.com/index.php?module=prod_detail&prod_id=992196.*

* cited by examiner

Primary Examiner — Richard Kearney
(74) *Attorney, Agent, or Firm* — Winston Hsu

(57) **CLAIM**

The ornamental design for a tri-proof lamp, as shown and described.

DESCRIPTION

FIG. 1 is a top, front, and right side perspective view for a tri-proof lamp showing our new design; FIG. 2 is a front elevation view thereof; FIG. 3 is a rear elevation view thereof; FIG. 4 is a left side elevation view thereof; FIG. 5 is a right side elevation view thereof; FIG. 6 is a top plan view thereof; and, FIG. 7 is a bottom plan view thereof.

1 Claim, 7 Drawing Sheets

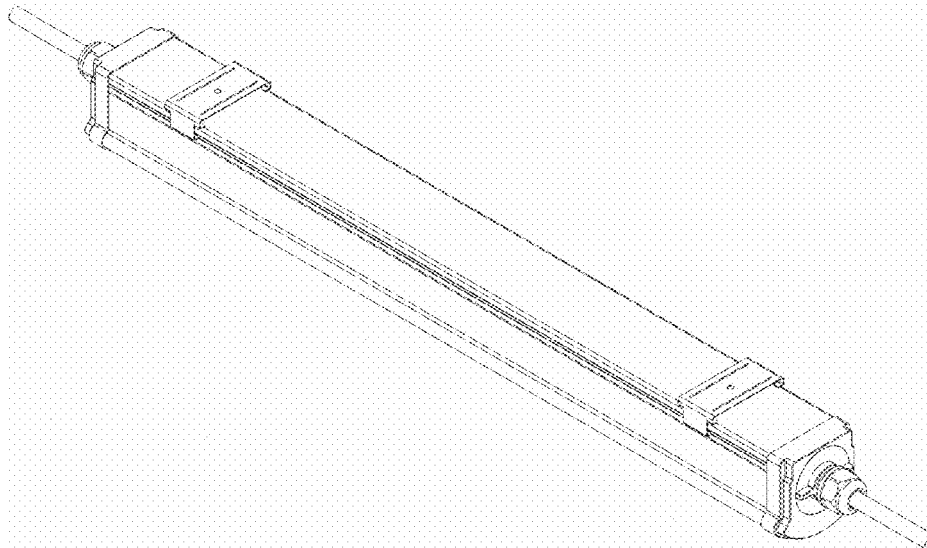

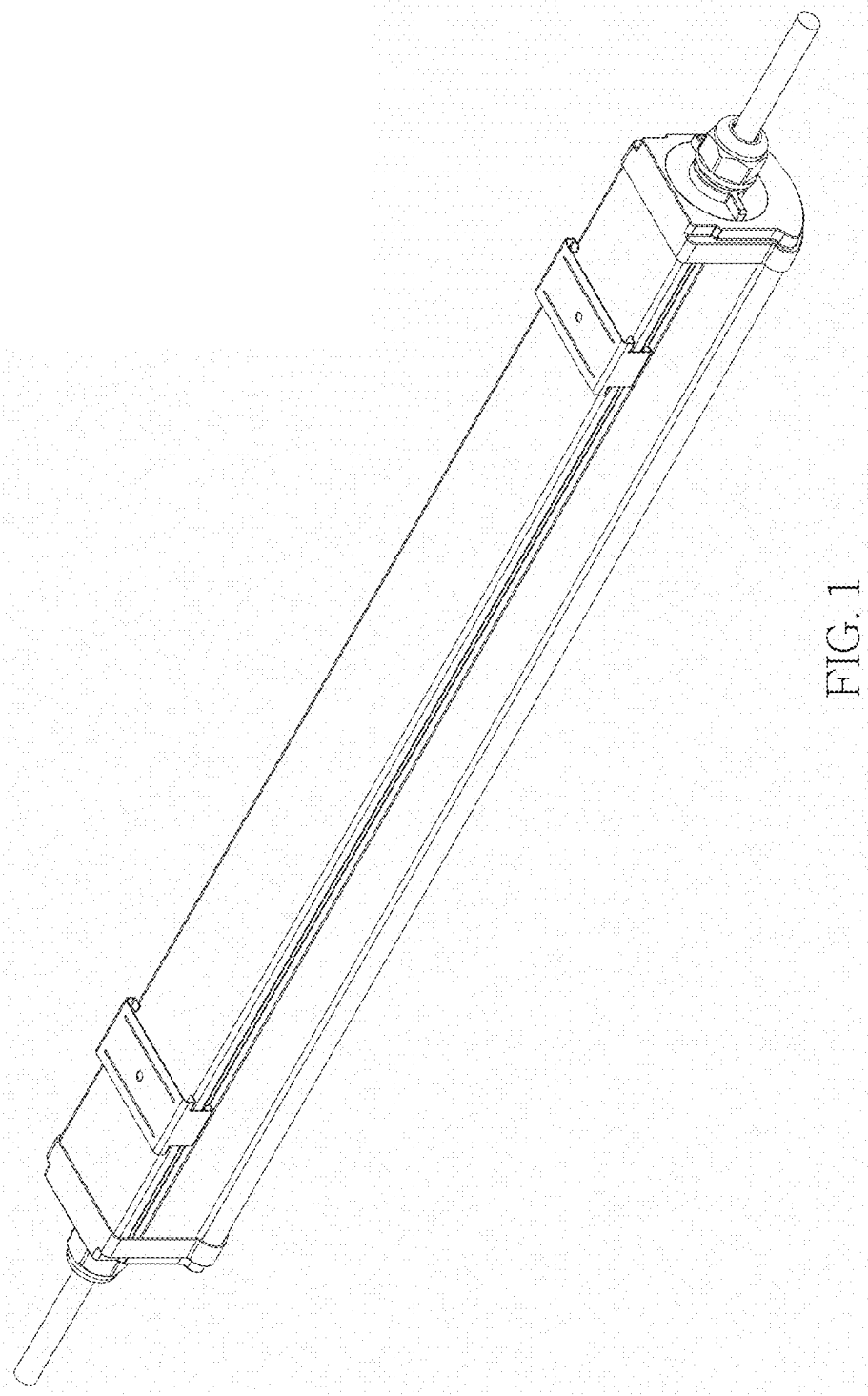

FIG. 1

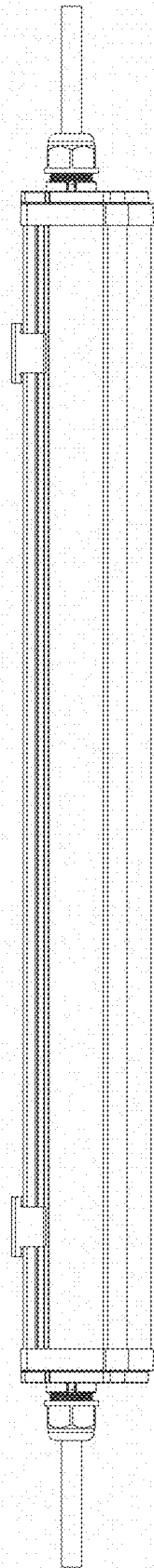

FIG. 2

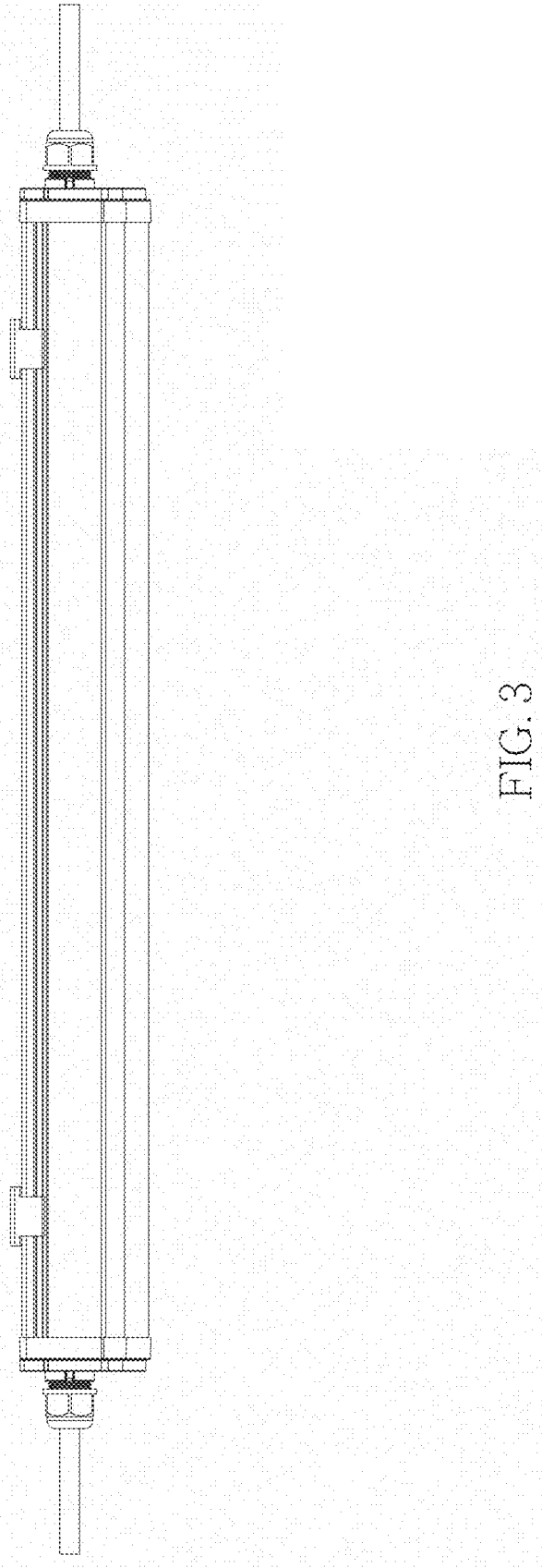

FIG. 3

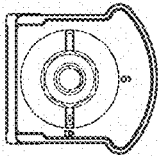

FIG. 4

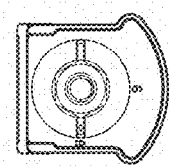

FIG. 5

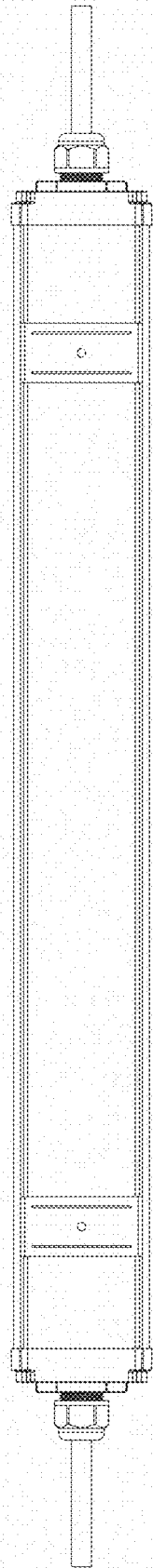

FIG. 6

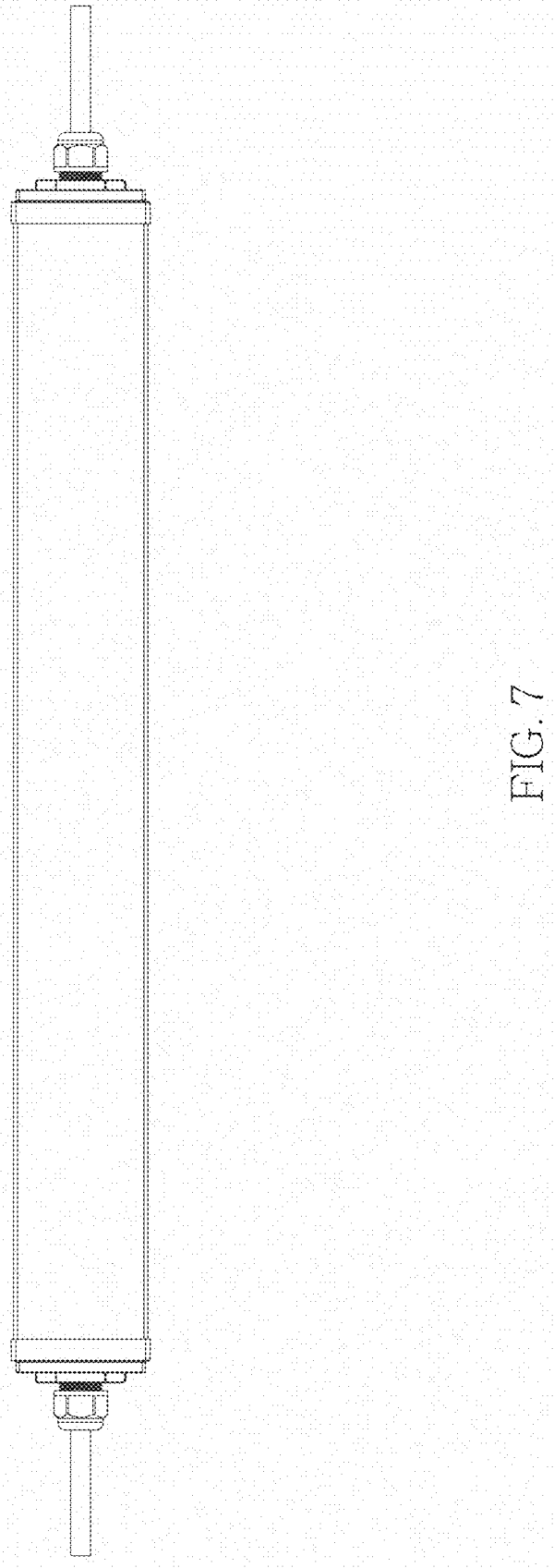

FIG. 7