



US00D447445B1

(12) **United States Design Patent**
Lu

(10) **Patent No.:** **US D447,445 S**

(45) **Date of Patent:** **** Sep. 4, 2001**

(54) **BABY'S STROLLER TABLE**

5,454,745 * 10/1995 Spielberg 446/227 X
5,709,582 * 1/1998 O'Donnell 446/227

(75) **Inventor:** **Pao Huny Lu, Taichung (TW)**

* cited by examiner

(73) **Assignee:** **Li Wei Lu, Taichung (TW)**

Primary Examiner—Kay H. Chin

(**) **Term:** **14 Years**

(74) *Attorney, Agent, or Firm*—Harrison & Egbert

(21) **Appl. No.:** **29/078,378**

(57) **CLAIM**

(22) **Filed:** **Oct. 27, 1997**

The ornamental design for a baby's stroller table, as shown.

(51) **LOC (7) Cl.** **12-12**

(52) **U.S. Cl.** **D12/133; D21/476; D12/130**

(58) **Field of Search** **D12/128-133;**
D6/332, 333, 339; D21/476; 297/56; 280/648;
446/227

DESCRIPTION

FIG. 1 is a perspective view of baby's stroller table showing my new design.

FIG. 2 is a front elevational view thereof;

FIG. 3 is a rear elevational view thereof;

FIG. 4 is a right elevational view thereof;

FIG. 5 is a left elevational view thereof;

FIG. 6 is a top plan view thereof; and,

FIG. 7 is a bottom plan view thereof.

(56) **References Cited**

U.S. PATENT DOCUMENTS

- D. 339,772 * 9/1993 Hu D12/133
- D. 376,393 * 12/1996 Stroud et al. D12/476
- D. 391,531 * 3/1998 Mak D12/130

1 Claim, 5 Drawing Sheets

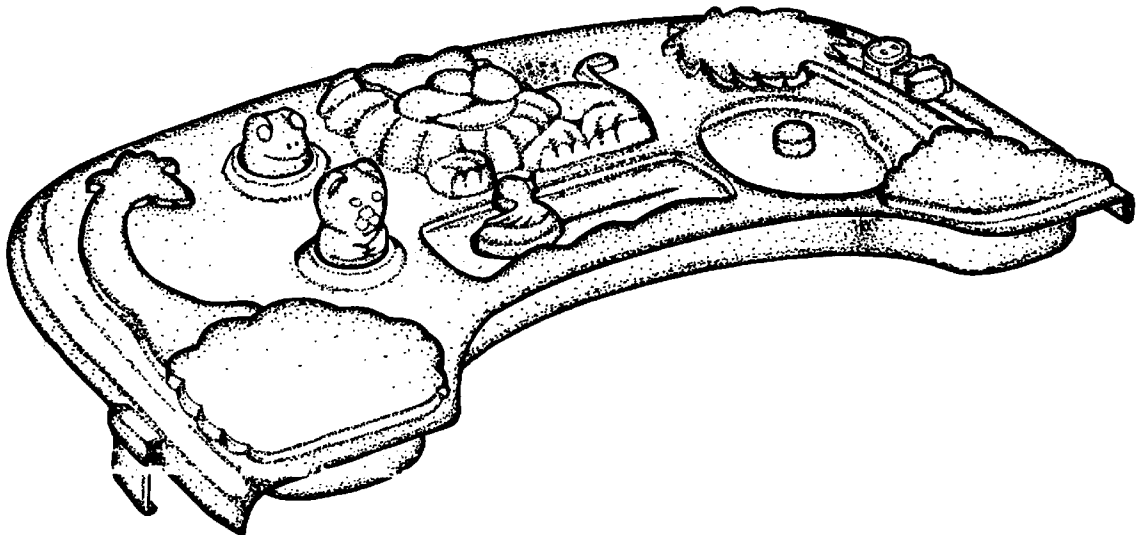

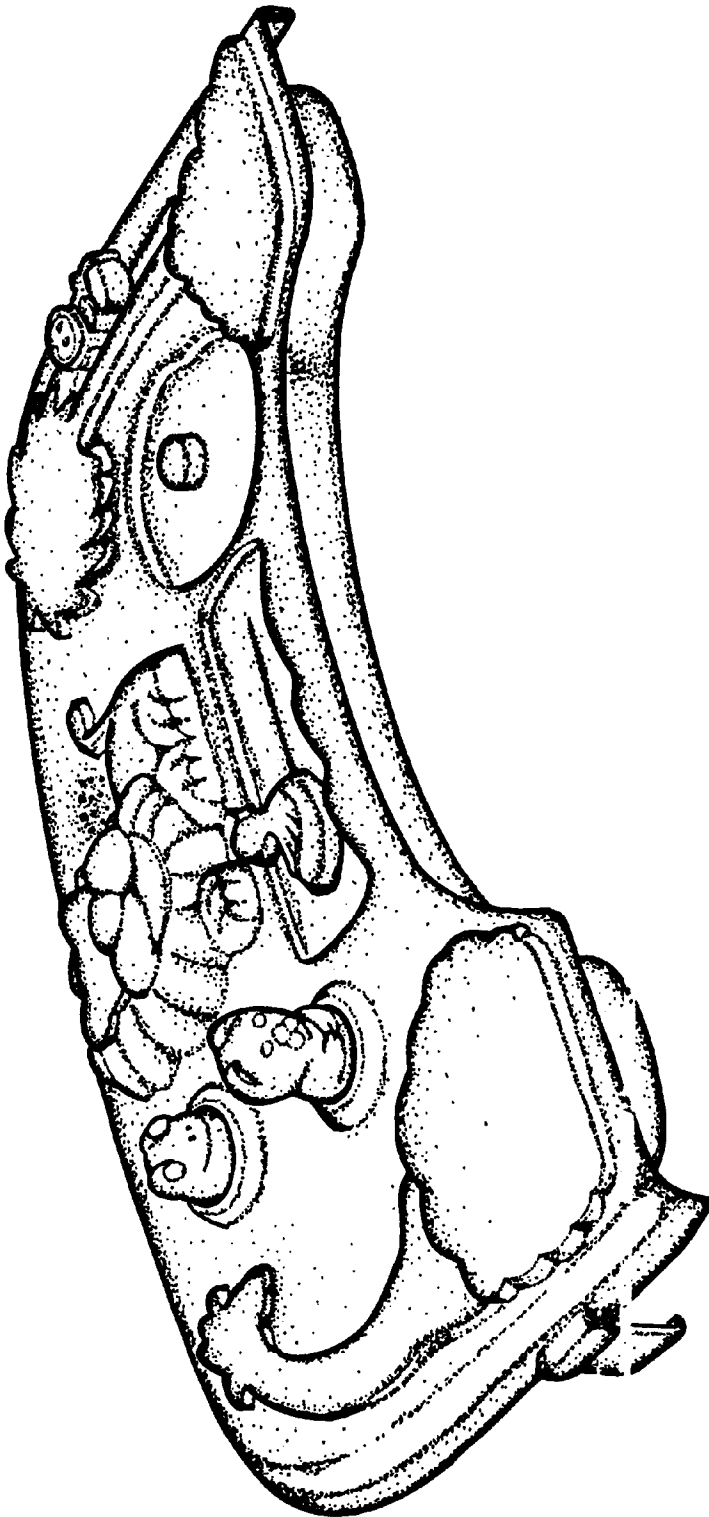

FIG.1

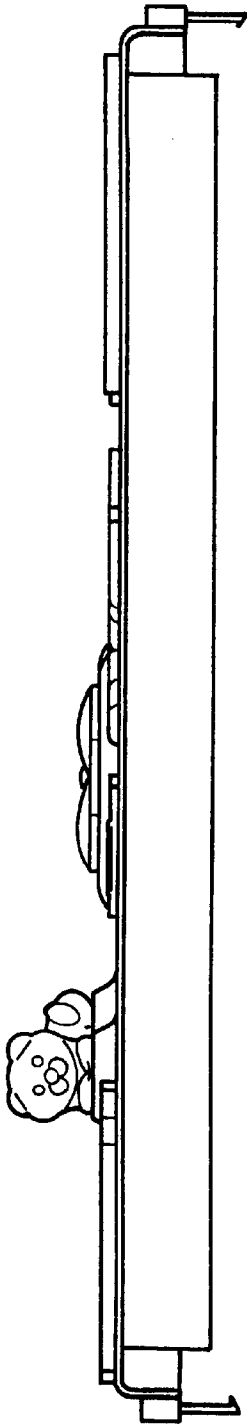

FIG. 2

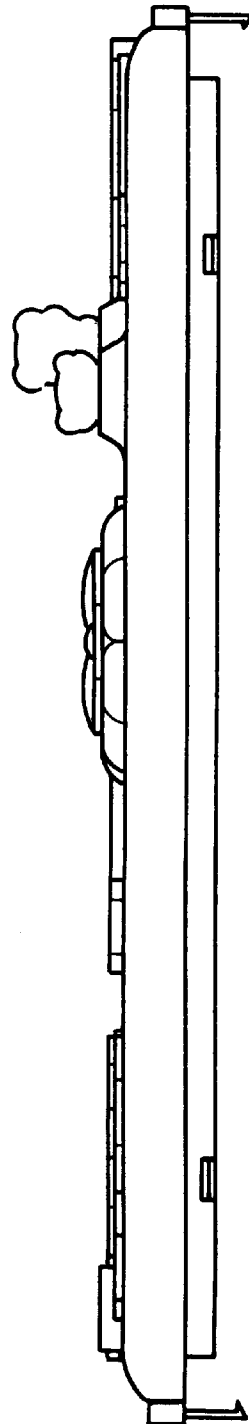

FIG. 3

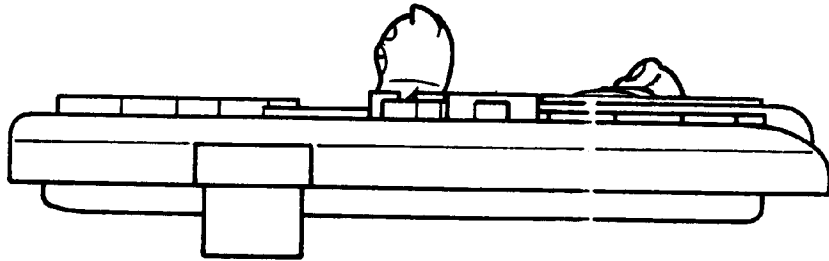

FIG.4

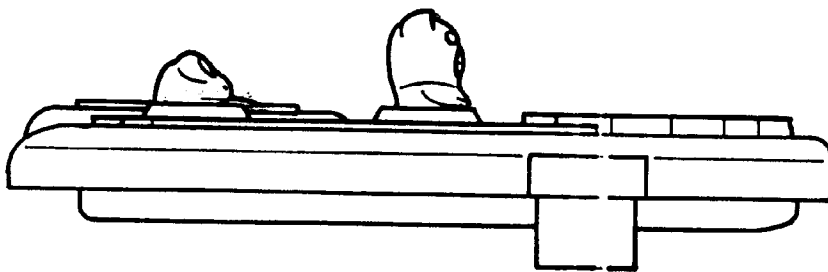

FIG.5

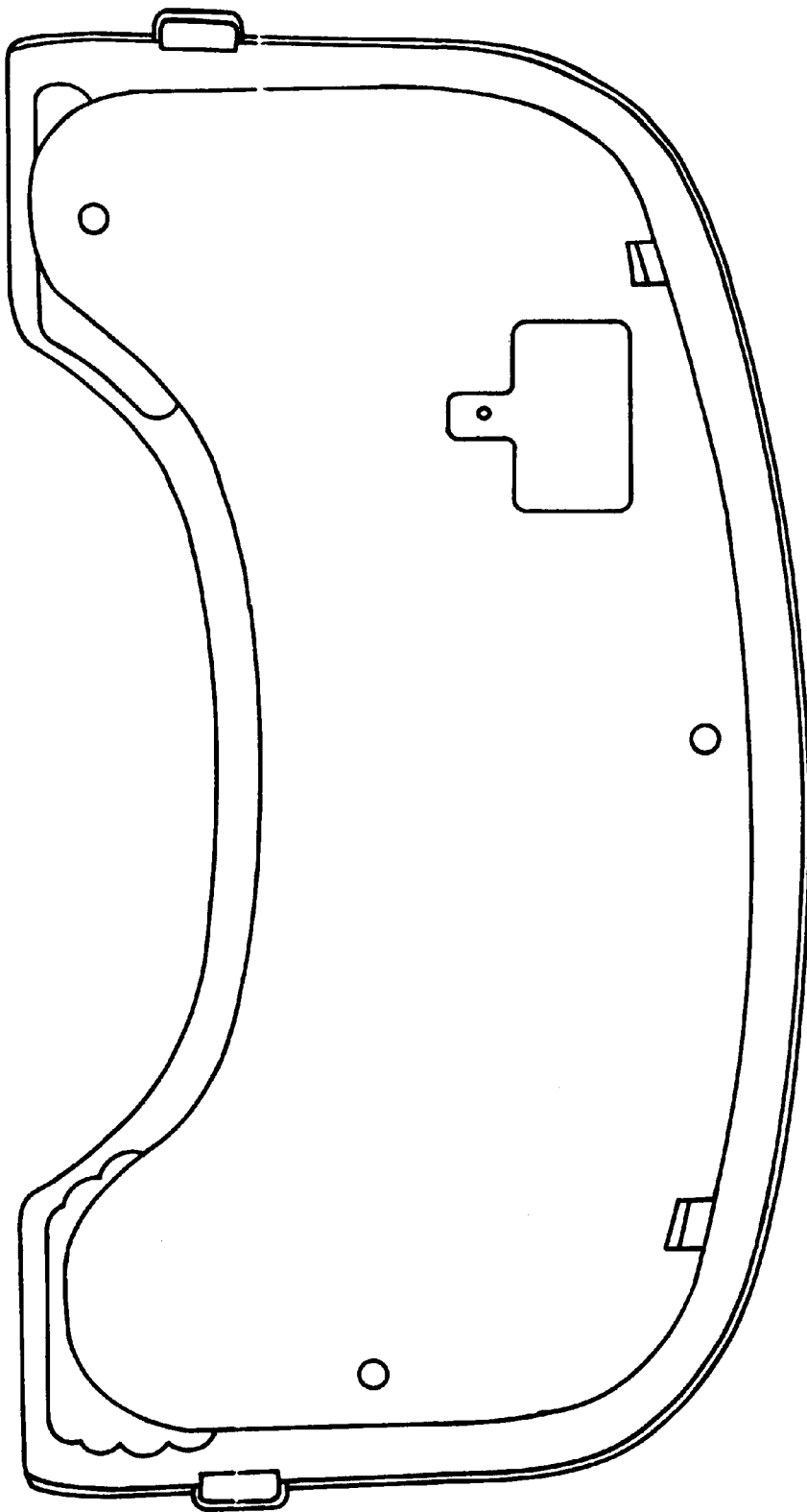

FIG.7