



US00D608640S

(12) **United States Design Patent**
Carreno

(10) **Patent No.:** **US D608,640 S**

(45) **Date of Patent:** **** Jan. 26, 2010**

(54) **LID FOR A BOTTLE**

(75) Inventor: **Alfredo Carreno**, Aurora, IL (US)

(73) Assignee: **Thermos L.L.C.**, Rolling Meadows, IL (US)

(**) Term: **14 Years**

(21) Appl. No.: **29/310,474**

(22) Filed: **Aug. 20, 2008**

(51) **LOC (9) Cl.** **09-07**

(52) **U.S. Cl.** **D9/449; D9/454**

(58) **Field of Classification Search** D9/556,
D9/529, 454, 453, 452, 449, 443, 439, 504,
D9/450, 447, 446, 730-732, 435; D8/312;
D7/392.1; D23/261; D14/217; D12/197;
229/123.1; 222/541.2, 575, 566, 556, 552,
222/519, 494, 480, 479, 212, 565; 220/288,
220/810, 781; 215/350, 344, 295, 270, 256,
215/252, 218, 216, 209, 206, 235, 236, 331,
215/220; 206/534; 116/308-315

See application file for complete search history.

(56) **References Cited**

U.S. PATENT DOCUMENTS

- D451,023 S * 11/2001 Kitamura et al. D9/449
- D528,862 S * 9/2006 Li D7/510
- D529,339 S * 10/2006 Carreno et al. D7/511

- D529,380 S * 10/2006 Yelland D9/447
- D530,203 S * 10/2006 Li D9/449
- D571,147 S * 6/2008 Rohe D7/392.1
- D589,743 S * 4/2009 Pearson D7/392
- D592,012 S * 5/2009 Carreno D7/510

* cited by examiner

Primary Examiner—Susan Bennett Hattan

(74) *Attorney, Agent, or Firm*—Wood, Phillips, Katz, Clark & Mortimer

(57) **CLAIM**

The ornamental design for a lid for a bottle, as shown and described.

DESCRIPTION

FIG. 1 is a perspective view from above and to the right of the lid for a bottle;

FIG. 2 is a perspective view from below and to the left of the lid;

FIG. 3 is a left side view of the lid;

FIG. 4 is a front elevation view of the lid;

FIG. 5 is a right side view of the lid;

FIG. 6 is a back elevation view of the lid; and,

FIG. 7 is a top plan view of the lid.

It is to be understood that the broken lines depict environmental subject matter only and form no part of the claimed design.

1 Claim, 4 Drawing Sheets

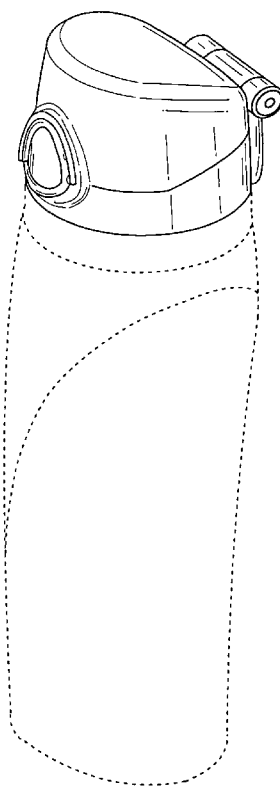

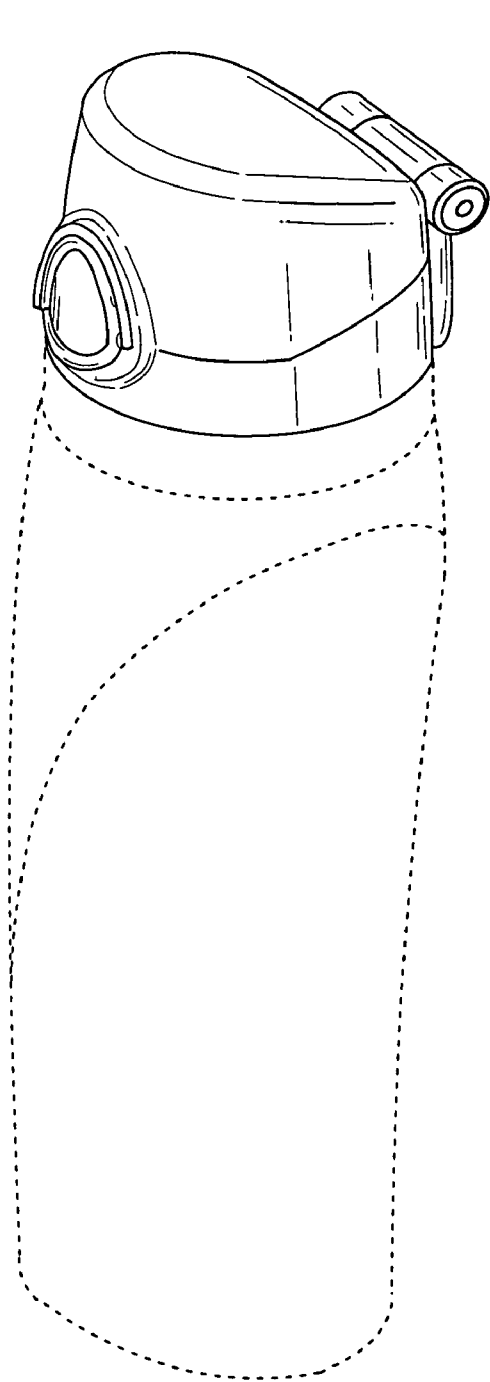

Fig. 1

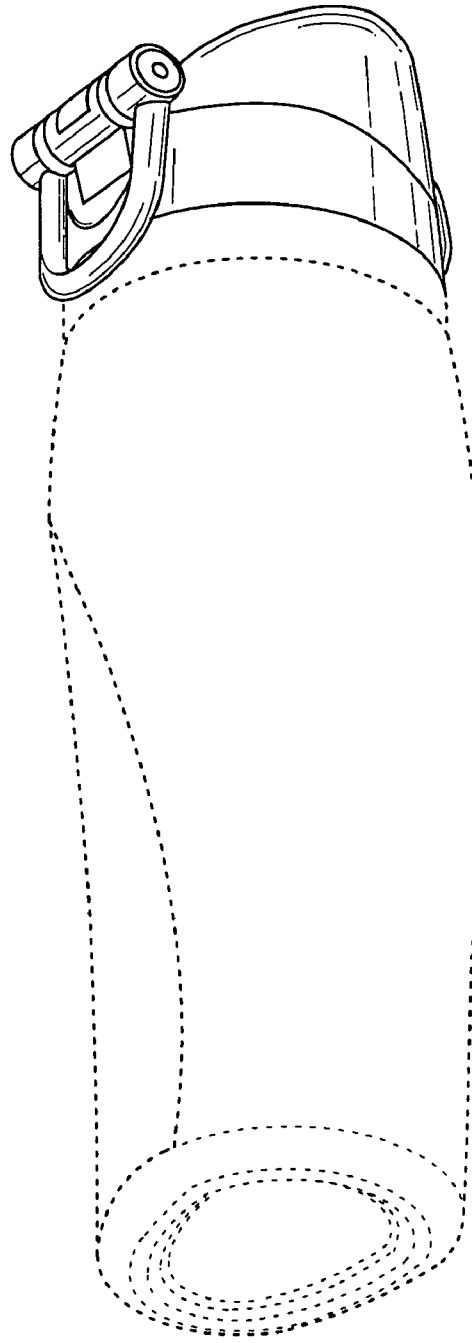

Fig. 2

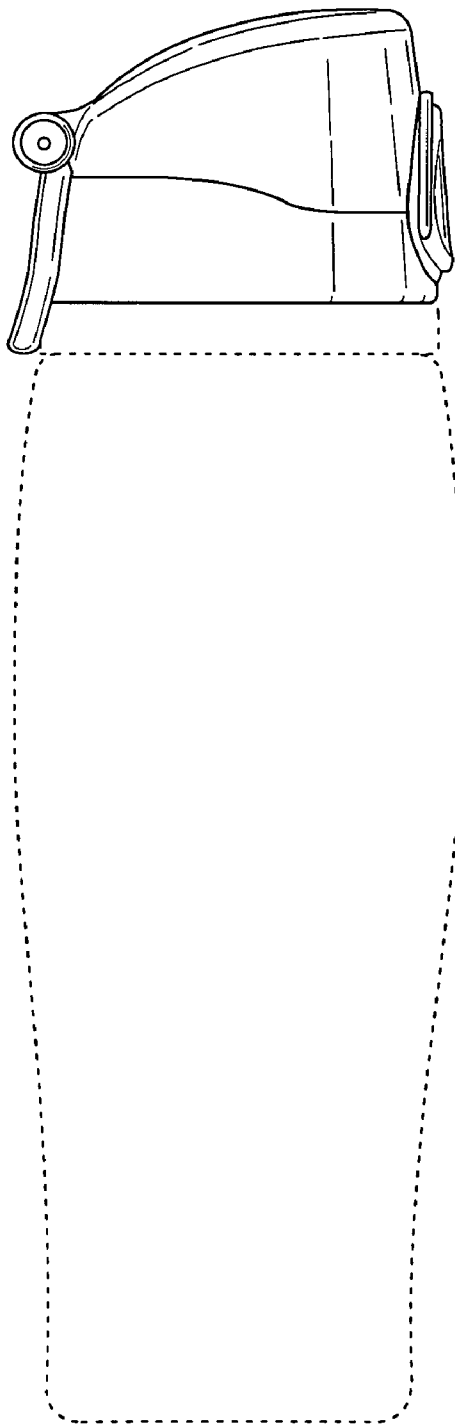

Fig. 3

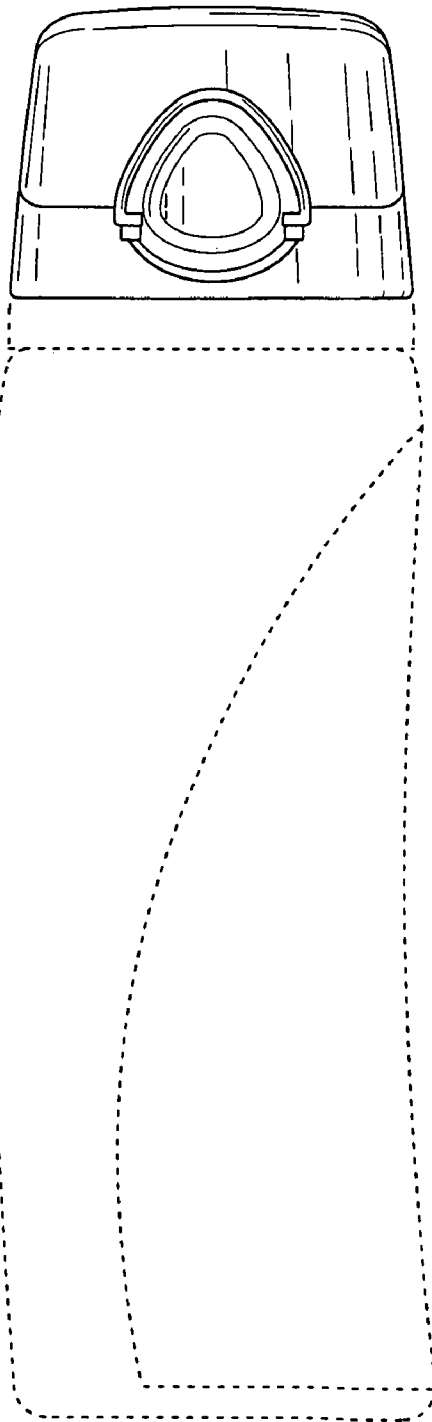

Fig. 4

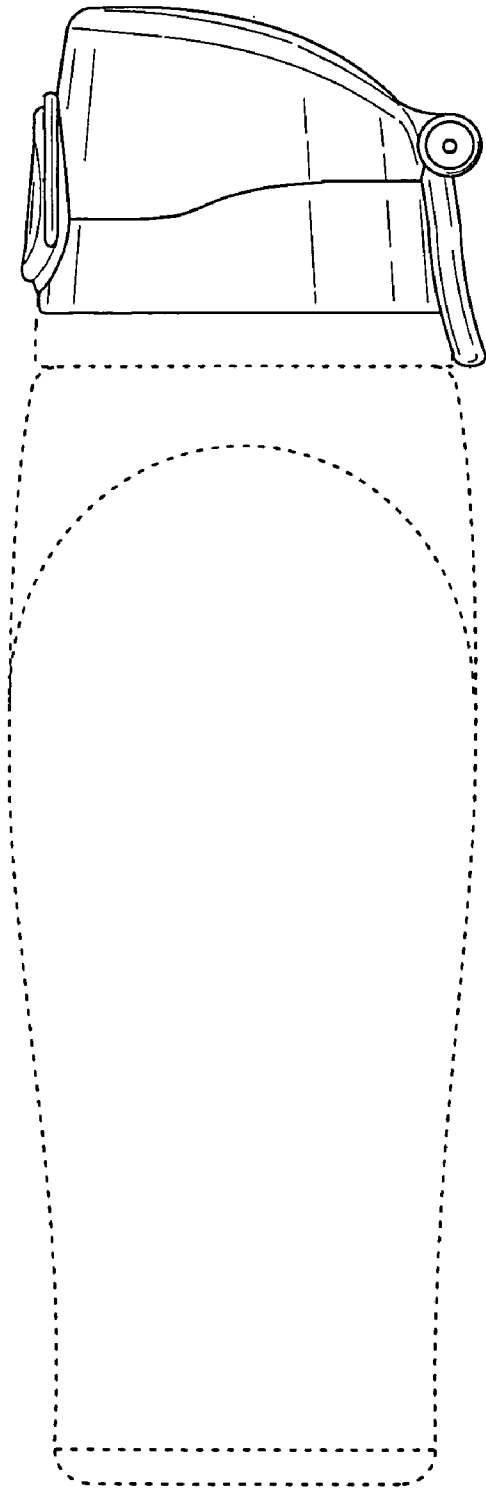

Fig. 5

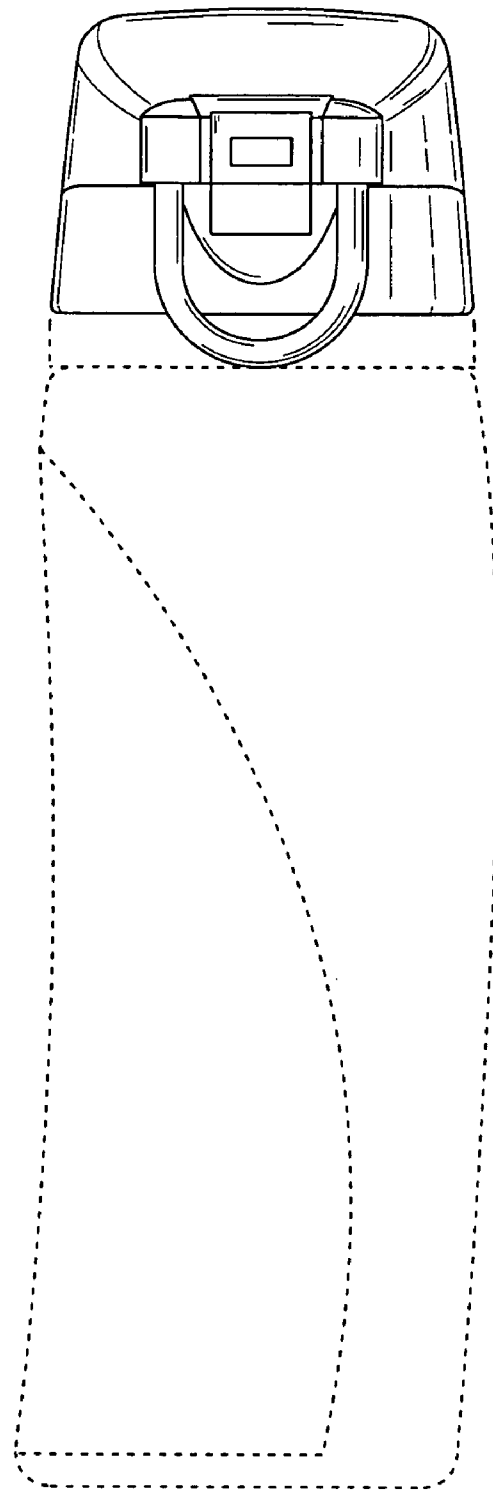

Fig. 6

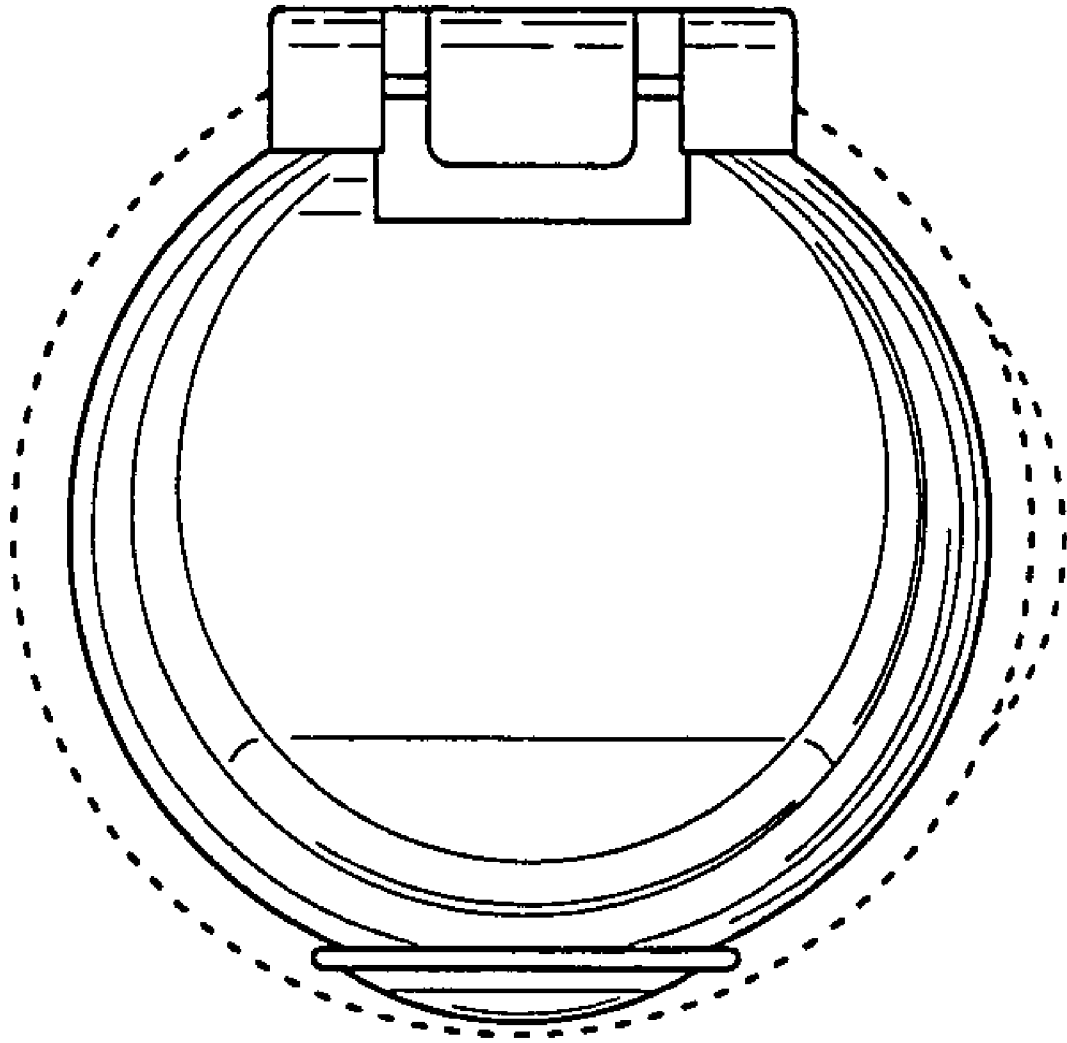

Fig. 7