



(51) International Patent Classification:

H04N 19/117 (2014.01) H04N 19/186 (2014.01)
H04N 19/157 (2014.01) H04N 19/54 (2014.01)

(21) International Application Number:

PCT/US2020/019945

(22) International Filing Date:

26 February 2020 (26.02.2020)

(25) Filing Language:

English

(26) Publication Language:

English

(30) Priority Data:

62/819,368 15 March 2019 (15.03.2019) US
16/800,832 25 February 2020 (25.02.2020) US

(71) Applicant: **QUALCOMM INCORPORATED** [US/US];
ATTN: International IP Administration, 5775 Morehouse
Drive, San Diego, California 92121-1714 (US).

(72) Inventors: **WANG, Hongtao**; 5775 Morehouse Drive, San
Diego, California 92121-1714 (US). **CHIEN, Wei-Jung**;
5775 Morehouse Drive, San Diego, California 92121-1714
(US). **SEREGIN, Vadim**; 5775 Morehouse Drive, San
Diego, California 92121-1714 (US). **KARCZEWICZ,
Marta**; 5775 Morehouse Drive, San Diego, California
92121-1714 (US).

(74) Agent: **DOBBS, Bryan G.**; Shumaker & Sieffert, P.A.,
1625 Radio Drive, Suite 300, Woodbury, Minnesota 55125
(US).

(81) Designated States (unless otherwise indicated, for every
kind of national protection available): AE, AG, AL, AM,
AO, AT, AU, AZ, BA, BB, BG, BH, BN, BR, BW, BY, BZ,
CA, CH, CL, CN, CO, CR, CU, CZ, DE, DJ, DK, DM, DO,
DZ, EC, EE, EG, ES, FI, GB, GD, GE, GH, GM, GT, HN,
HR, HU, ID, IL, IN, IR, IS, JO, JP, KE, KG, KH, KN, KP,
KR, KW, KZ, LA, LC, LK, LR, LS, LU, LY, MA, MD, ME,
MG, MK, MN, MW, MX, MY, MZ, NA, NG, NI, NO, NZ,
OM, PA, PE, PG, PH, PL, PT, QA, RO, RS, RU, RW, SA,
SC, SD, SE, SG, SK, SL, ST, SV, SY, TH, TJ, TM, TN, TR,
TT, TZ, UA, UG, US, UZ, VC, VN, WS, ZA, ZM, ZW.

(84) Designated States (unless otherwise indicated, for every
kind of regional protection available): ARIPO (BW, GH,
GM, KE, LR, LS, MW, MZ, NA, RW, SD, SL, ST, SZ, TZ,
UG, ZM, ZW), Eurasian (AM, AZ, BY, KG, KZ, RU, TJ,
TM), European (AL, AT, BE, BG, CH, CY, CZ, DE, DK,
EE, ES, FI, FR, GB, GR, HR, HU, IE, IS, IT, LT, LU, LV,
MC, MK, MT, NL, NO, PL, PT, RO, RS, SE, SI, SK, SM,
TR), OAPI (BF, BJ, CF, CG, CI, CM, GA, GN, GQ, GW,
KM, ML, MR, NE, SN, TD, TG).

(54) Title: VIDEO CODING IN TRIANGULAR PREDICTION UNIT MODE USING DIFFERENT CHROMA FORMATS

(57) Abstract: A device for processing video data includes a memory configured to store video data and one or more processors implemented in circuitry. The one or more processors are configured to generate a coding unit for chroma components of a block of video data. The one or more processors are configured to split the coding unit for chroma components into a first triangle-shaped partition and a second triangle-shaped partition. The one or more processors are configured to apply pixel blending using a set of weights for a YUV 4:2:0 format to generate a predicted block for the chroma components of the block of video data when the one or more processors generate the coding unit for chroma components in the YUV 4:2:0 format and when the one or more processors generate the coding unit for chroma components in a YUV 4:4:4 format.

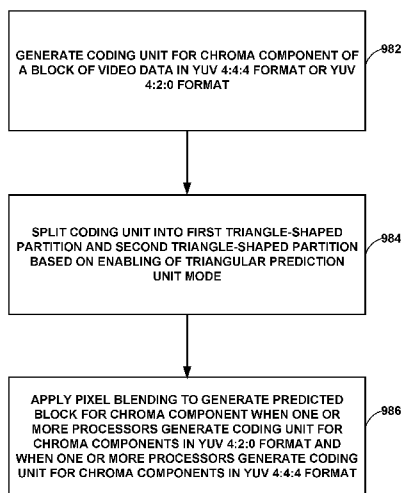

FIG. 10



Published:

— *with international search report (Art. 21(3))*

VIDEO CODING IN TRIANGULAR PREDICTION UNIT MODE USING DIFFERENT CHROMA FORMATS

[0001] This Application claims priority to U.S. Application No. **16/800,832**, filed February 25, 2020 which claims the benefit of U.S. Provisional Patent Application **62/819,368**, filed March 15, 2019, the entire contents of which are hereby incorporated by reference.

TECHNICAL FIELD

[0002] This disclosure relates to video encoding and video decoding.

BACKGROUND

[0003] Digital video capabilities can be incorporated into a wide range of devices, including digital televisions, digital direct broadcast systems, wireless broadcast systems, personal digital assistants (PDAs), laptop or desktop computers, tablet computers, e-book readers, digital cameras, digital recording devices, digital media players, video gaming devices, video game consoles, cellular or satellite radio telephones, so-called “smart phones,” video teleconferencing devices, video streaming devices, and the like. Digital video devices implement video coding techniques, such as those described in the standards defined by MPEG-2, MPEG-4, ITU-T H.263, ITU-T H.264/MPEG-4, Part 10, Advanced Video Coding (AVC), ITU-T H.265/High Efficiency Video Coding (HEVC), and extensions of such standards. The video devices may transmit, receive, encode, decode, and/or store digital video information more efficiently by implementing such video coding techniques.

[0004] Video coding techniques include spatial (intra-picture) prediction and/or temporal (inter-picture) prediction to reduce or remove redundancy inherent in video sequences. For block-based video coding, a video slice (e.g., a video picture or a portion of a video picture) may be partitioned into video blocks, which may also be referred to as coding tree units (CTUs), coding units (CUs) and/or coding nodes. Video blocks in an intra-coded (I) slice of a picture are encoded using spatial prediction with respect to reference samples in neighboring blocks in the same picture. Video blocks in an inter-coded (P or B) slice of a picture may use spatial prediction with respect to reference samples in neighboring blocks in the same picture or temporal prediction with respect to reference samples in other reference pictures. Pictures may be referred to as frames, and reference pictures may be referred to as reference frames.

SUMMARY

[0005] In general, this disclosure describes techniques for supporting different chroma formats in video codecs.

[0006] In one example, a method of processing video data includes: generating, by one or more processors implemented in circuitry, a coding unit for a chroma component of a block of video data in a YUV 4:4:4 format or in a YUV 4:2:0 format; splitting, by the one or more processors, the coding unit for the chroma component into a first triangle-shaped partition and a second triangle-shaped partition based on enabling of a triangular prediction unit mode; and applying, by the one or more processors, pixel blending using a set of weights for the YUV 4:2:0 format to generate a predicted block for the chroma component when the one or more processors generate the coding unit for the chroma component in the YUV 4:2:0 format and when the one or more processors generate the coding unit for the chroma component in the YUV 4:4:4 format, wherein applying pixel blending comprises determining weighted averages, using the set of weights for the YUV 4:2:0 format, of collocated motion compensated pixels of the first triangle-shaped partition and the second triangle-shaped partition based on motion information of the first triangle-shaped partition and the second triangle-shaped partition, respectively.

[0007] In another example, a device for processing video data includes: a memory configured to store video data; and one or more processors implemented in circuitry. The one or more processors are configured to: generate a coding unit for a chroma component of a block of video data in a YUV 4:4:4 format or in a YUV 4:2:0 format; split the coding unit for the chroma component into a first triangle-shaped partition and a second triangle-shaped partition based on enabling of a triangular prediction unit mode; and apply pixel blending using a set of weights for the YUV 4:2:0 format to generate a predicted block for the chroma component when the one or more processors generate the coding unit for the chroma component in the YUV 4:2:0 format and when the one or more processors generate the coding unit for the chroma component in the YUV 4:4:4 format, wherein, to apply pixel blending, the one or more processors are configured to determine weighted averages, using the set of weights for the YUV 4:2:0 format, of collocated motion compensated pixels of the first triangle-shaped partition and the second triangle-shaped partition based on motion information of the first triangle-shaped partition and the second triangle-shaped partition, respectively.

[0008] In one example, a computer-readable storage medium includes stored thereon instructions that, when executed, cause one or more processors to: generate a coding unit for a chroma component of a block of video data in a YUV 4:4:4 format or in a YUV 4:2:0 format; split the coding unit for the chroma component into a first triangle-shaped partition and a second triangle-shaped partition based on enabling of a triangular prediction unit mode; and apply pixel blending using a set of weights for the YUV 4:2:0 format to generate a predicted block for the chroma component when the one or more processors generate the coding unit for the chroma component in the YUV 4:2:0 format and when the one or more processors generate the coding unit for the chroma component in the YUV 4:4:4 format, wherein the instructions that cause the one or more processors to apply pixel blending cause the one or more processors to determine weighted averages, using the set of weights for the YUV 4:2:0 format, of collocated motion compensated pixels of the first triangle-shaped partition and the second triangle-shaped partition based on motion information of the first triangle-shaped partition and the second triangle-shaped partition, respectively.

[0009] In another example, a device for coding video data includes: means for generating a coding unit for a chroma component of a block of video data in a YUV 4:4:4 format or in a YUV 4:2:0 format; means for splitting the coding unit for the chroma component into a first triangle-shaped partition and a second triangle-shaped partition based on enabling of a triangular prediction unit mode; and means for applying pixel blending using a set of weights for the YUV 4:2:0 format to generate a predicted block for the chroma component when the one or more processors generate the coding unit for the chroma component in the YUV 4:2:0 format and when the one or more processors generate the coding unit for the chroma component in the YUV 4:4:4 format, wherein the means for applying pixel blending comprises means for determining weighted averages, using the set of weights for the YUV 4:2:0 format, of collocated motion compensated pixels of the first triangle-shaped partition and the second triangle-shaped partition based on motion information of the first triangle-shaped partition and the second triangle-shaped partition, respectively.

[0010] In one example, a method of processing video data includes: obtaining, by one or more processors implemented in circuitry, unfiltered reference samples for an area of a picture, wherein the one or more processors are configured to disable intra-reference sample smoothing of the unfiltered reference samples for chroma samples in a YUV 4:2:0 format and in a YUV 4:4:4 format; and generating, by the one or more processors,

using intra-prediction, chroma samples of a predicted block for a block of the picture based on the unfiltered reference samples when generating the chroma components in the YUV 4:2:0 format and when generating the chroma components in the YUV 4:4:4 format.

[0011] In another example, a device for processing video data includes: a memory configured to store video data; and one or more processors implemented in circuitry and configured to: obtain unfiltered reference samples for an area of a picture of the video data, wherein the one or more processors are configured to disable intra-reference sample smoothing of the unfiltered reference samples for chroma samples in a YUV 4:2:0 format and in a YUV 4:4:4 format; and generate, using intra-prediction, chroma samples of a predicted block for a block of the picture based on the unfiltered reference samples when generating the chroma components in the YUV 4:2:0 format and when generating the chroma components in the YUV 4:4:4 format.

[0012] In one example, a computer-readable storage medium includes stored thereon instructions that, when executed, cause one or more processors to: obtain unfiltered reference samples for an area of a picture of the video data, wherein the instructions further cause the one or more processors to disable intra-reference sample smoothing of the unfiltered reference samples for chroma samples in a YUV 4:2:0 format and in a YUV 4:4:4 format; and generate, using intra-prediction, chroma samples of a predicted block for a block of the picture based on the unfiltered reference samples when generating the chroma components in the YUV 4:2:0 format and when generating the chroma components in the YUV 4:4:4 format.

[0013] In another example, a device for coding video data includes: means for obtaining unfiltered reference samples for an area of a picture; and means for generating, using intra-prediction, chroma samples of a predicted block for a block of the picture based on the unfiltered reference samples when generating the chroma components in a YUV 4:2:0 format and when generating the chroma components in a YUV 4:4:4 format.

[0014] The details of one or more examples are set forth in the accompanying drawings and the description below. Other features, objects, and advantages will be apparent from the description, drawings, and claims.

BRIEF DESCRIPTION OF DRAWINGS

[0015] FIG. 1 is a block diagram illustrating an example video encoding and decoding system that may perform the techniques of this disclosure.

[0016] FIGS. 2A and 2B are conceptual diagrams illustrating an example quadtree binary tree (QTBT) structure, and a corresponding coding tree unit (CTU).

[0017] FIG. 3 is a block diagram illustrating an example video encoder that may perform the techniques of this disclosure.

[0018] FIG. 4 is a block diagram illustrating an example video decoder that may perform the techniques of this disclosure.

[0019] FIG. 5A is a conceptual diagram illustrating a first example of splitting a coding unit into a first triangle-shaped partition and a second triangle-shaped partition based on inter prediction, in accordance with the techniques of the disclosure.

[0020] FIG. 5B is a conceptual diagram illustrating a second example of splitting a coding unit into a first triangle-shaped partition and a second triangle-shaped partition based on inter prediction, in accordance with the techniques of the disclosure.

[0021] FIG. 6 is a conceptual diagram illustrating pixel blending with one set of weights, in accordance with the techniques of the disclosure.

[0022] FIG. 7A is a conceptual diagram illustrating further details of a first triangle-shaped partition for the pixel blending of FIG. 6, in accordance with the techniques of the disclosure.

[0023] FIG. 7B is a conceptual diagram illustrating further details of a second triangle-shaped partition for the pixel blending of FIG. 6, in accordance with the techniques of the disclosure.

[0024] FIG. 7C is a conceptual diagram illustrating further details of a block formed using the pixel blending of FIG. 6, in accordance with the techniques of the disclosure.

[0025] FIG. 8 is a flowchart illustrating an example method for encoding a current block, in accordance with the techniques of the disclosure.

[0026] FIG. 9 is a flowchart illustrating an example method for decoding a current block of video data, in accordance with the techniques of the disclosure.

[0027] FIG. 10 is a flowchart illustrating an example process for pixel blending of chroma components for a block of video data with a set of weights for a YUV 4:2:0 sampling format, in accordance with the techniques of the disclosure.

[0028] FIG. 11 is a flowchart illustrating an example process for generating chroma samples of a prediction block using intra-prediction.

DETAILED DESCRIPTION

[0029] As described in more detail below, the disclosure describes example techniques for improving an encoding and/or decoding of chroma components in different formats. For example, when using triangular prediction unit (PU) mode, a video coder (e.g., a video encoder or video decoder) may split a PU into two triangle-shaped partitions. In this example, the video coder may generate motion compensated triangle-shaped partitions and combine the motion compensated triangle-shaped partitions using a set of weights that are based on the chroma format. For example, the video coder may apply pixel blending using a first set of weights when chroma components are in a YUV 4:4:4 format and apply a second set of weights, different from the first set of weights, when chroma components are in a YUV 4:2:0 format. However, using different sets of weights for different chroma formats may increase a complexity of generating the chroma components.

[0030] In accordance with the techniques of the disclosure, a video coder (e.g., a video encoder or video decoder) may be configured to unify a treatment of chroma components for different chroma formats. For example, the video coder may apply pixel blending using a set of weights for a YUV 4:2:0 format when chroma components are in a YUV 4:4:4 format and apply the set of weights for the YUV 4:2:0 format when chroma components are in the YUV 4:2:0 format.

[0031] In some examples, a video coder (e.g., a video encoder or a video decoder) may be configured to generate chroma samples of a prediction block for a block of video data using unfiltered reference samples when intra-prediction is used and when chroma components are in a YUV 4:2:0 format. In this example, the video coder may be configured to generate chroma samples of a prediction block for a block of video data using filtered reference samples when intra-prediction is used and when chroma components are in a YUV 4:4:4 format. However, using different reference samples for different chroma formats may increase a complexity of generating the chroma components.

[0032] In accordance with the techniques of the disclosure, a video coder (e.g., a video encoder or video decoder) may be configured to unify a treatment of chroma components for different chroma formats. For example, the video coder may be configured to disable intra reference sample smoothing when chroma components are in a YUV 4:2:0 format and when chroma components are in a YUV 4:4:4 format. For example, the video coder may generate chroma samples of a prediction block for a

block of video data using unfiltered reference samples when chroma components are in a YUV 4:2:0 format and when chroma components are in a YUV 4:4:4 format.

[0033] Techniques described herein for unifying a treatment of chroma components may be applied to any of the existing video codecs, such as HEVC (High Efficiency Video Coding), or video codecs under development such as VVC (Versatile Video Coding), or be an efficient coding tool in any future video coding standards. While examples of describes techniques related to weighted prediction are described with relation to HEVC and on-going works in Versatile Video Coding (VVC), techniques described herein may be applied to other existing video codecs and/or future video coding standards.

[0034] FIG. 1 is a block diagram illustrating an example video encoding and decoding system 100 that may perform the techniques of this disclosure. The techniques of this disclosure are generally directed to coding (encoding and/or decoding) video data. In general, video data includes any data for processing a video. Thus, video data may include raw, uncoded video, encoded video, decoded (e.g., reconstructed) video, and video metadata, such as signaling data.

[0035] As shown in FIG. 1, system 100 includes a source device 102 that provides encoded video data to be decoded and displayed by a destination device 116, in this example. In particular, source device 102 provides the video data to destination device 116 via a computer-readable medium 110. Source device 102 and destination device 116 may comprise any of a wide range of devices, including desktop computers, notebook (i.e., laptop) computers, tablet computers, set-top boxes, telephone handsets such smartphones, televisions, cameras, display devices, digital media players, video gaming consoles, video streaming device, or the like. In some cases, source device 102 and destination device 116 may be equipped for wireless communication, and thus may be referred to as wireless communication devices.

[0036] In the example of FIG. 1, source device 102 includes video source 104, memory 106, video encoder 200, and output interface 108. Destination device 116 includes input interface 122, video decoder 300, memory 120, and display device 118. In accordance with this disclosure, video encoder 200 of source device 102 and video decoder 300 of destination device 116 may be configured to apply the techniques for unifying weight information for different chroma formats. Thus, source device 102 represents an example of a video encoding device, while destination device 116 represents an example of a video decoding device. In other examples, a source device

and a destination device may include other components or arrangements. For example, source device 102 may receive video data from an external video source, such as an external camera. Likewise, destination device 116 may interface with an external display device, rather than including an integrated display device.

[0037] System 100 as shown in FIG. 1 is merely one example. In general, any digital video encoding and/or decoding device may perform techniques for determining weight information for a first chroma format, determining weight information for a second chroma format different from the first chroma format to correspond to the weight information for the first chroma format, and generating prediction information based on the weight information for the first chroma format. Source device 102 and destination device 116 are merely examples of such coding devices in which source device 102 generates coded video data for transmission to destination device 116. This disclosure refers to a “coding” device as a device that performs coding (encoding and/or decoding) of data. Thus, video encoder 200 and video decoder 300 represent examples of coding devices, in particular, a video encoder and a video decoder, respectively. In some examples, devices 102, 116 may operate in a substantially symmetrical manner such that each of devices 102, 116 include video encoding and decoding components. Hence, system 100 may support one-way or two-way video transmission between video devices 102, 116, e.g., for video streaming, video playback, video broadcasting, or video telephony.

[0038] In general, video source 104 represents a source of video data (i.e., raw, uncoded video data) and provides a sequential series of pictures (also referred to as “frames”) of the video data to video encoder 200, which encodes data for the pictures. Video source 104 of source device 102 may include a video capture device, such as a video camera, a video archive containing previously captured raw video, and/or a video feed interface to receive video from a video content provider. As a further alternative, video source 104 may generate computer graphics-based data as the source video, or a combination of live video, archived video, and computer-generated video. In each case, video encoder 200 encodes the captured, pre-captured, or computer-generated video data. Video encoder 200 may rearrange the pictures from the received order (sometimes referred to as “display order”) into a coding order for coding. Video encoder 200 may generate a bitstream including encoded video data. Source device 102 may then output the encoded video data via output interface 108 onto computer-readable medium 110 for reception and/or retrieval by, e.g., input interface 122 of destination device 116.

[0039] Memory 106 of source device 102 and memory 120 of destination device 116 represent general purpose memories. In some example, memories 106, 120 may store raw video data, e.g., raw video from video source 104 and raw, decoded video data from video decoder 300. Additionally, or alternatively, memories 106, 120 may store software instructions executable by, e.g., video encoder 200 and video decoder 300, respectively. Although shown separately from video encoder 200 and video decoder 300 in this example, it should be understood that video encoder 200 and video decoder 300 may also include internal memories for functionally similar or equivalent purposes. Furthermore, memories 106, 120 may store encoded video data, e.g., output from video encoder 200 and input to video decoder 300. In some examples, portions of memories 106, 120 may be allocated as one or more video buffers, e.g., to store raw, decoded, and/or encoded video data.

[0040] Computer-readable medium 110 may represent any type of medium or device capable of transporting the encoded video data from source device 102 to destination device 116. In one example, computer-readable medium 110 represents a communication medium to enable source device 102 to transmit encoded video data directly to destination device 116 in real-time, e.g., via a radio frequency network or computer-based network. Output interface 108 may modulate a transmission signal including the encoded video data, and input interface 122 may modulate the received transmission signal, according to a communication standard, such as a wireless communication protocol. The communication medium may comprise any wireless or wired communication medium, such as a radio frequency (RF) spectrum or one or more physical transmission lines. The communication medium may form part of a packet-based network, such as a local area network, a wide-area network, or a global network such as the Internet. The communication medium may include routers, switches, base stations, or any other equipment that may be useful to facilitate communication from source device 102 to destination device 116.

[0041] In some examples, source device 102 may output encoded data from output interface 108 to storage device 116. Similarly, destination device 116 may access encoded data from storage device 116 via input interface 122. Storage device 116 may include any of a variety of distributed or locally accessed data storage media such as a hard drive, Blu-ray discs, DVDs, CD-ROMs, flash memory, volatile or non-volatile memory, or any other suitable digital storage media for storing encoded video data.

[0042] In some examples, source device 102 may output encoded video data to file server 114 or another intermediate storage device that may store the encoded video generated by source device 102. Destination device 116 may access stored video data from file server 114 via streaming or download. File server 114 may be any type of server device capable of storing encoded video data and transmitting that encoded video data to the destination device 116. File server 114 may represent a web server (e.g., for a website), a File Transfer Protocol (FTP) server, a content delivery network device, or a network attached storage (NAS) device. Destination device 116 may access encoded video data from file server 114 through any standard data connection, including an Internet connection. This may include a wireless channel (e.g., a Wi-Fi connection), a wired connection (e.g., DSL, cable modem, etc.), or a combination of both that is suitable for accessing encoded video data stored on file server 114. File server 114 and input interface 122 may be configured to operate according to a streaming transmission protocol, a download transmission protocol, or a combination thereof.

[0043] Output interface 108 and input interface 122 may represent wireless transmitters/receiver, modems, wired networking components (e.g., Ethernet cards), wireless communication components that operate according to any of a variety of IEEE 802.11 standards, or other physical components. In examples where output interface 108 and input interface 122 comprise wireless components, output interface 108 and input interface 122 may be configured to transfer data, such as encoded video data, according to a cellular communication standard, such as 4G, 4G-LTE (Long-Term Evolution), LTE Advanced, 5G, or the like. In some examples where output interface 108 comprises a wireless transmitter, output interface 108 and input interface 122 may be configured to transfer data, such as encoded video data, according to other wireless standards, such as an IEEE 802.11 specification, an IEEE 802.15 specification (e.g., ZigBee™), a Bluetooth™ standard, or the like. In some examples, source device 102 and/or destination device 116 may include respective system-on-a-chip (SoC) devices. For example, source device 102 may include an SoC device to perform the functionality attributed to video encoder 200 and/or output interface 108, and destination device 116 may include an SoC device to perform the functionality attributed to video decoder 300 and/or input interface 122.

[0044] The techniques of this disclosure may be applied to video coding in support of any of a variety of multimedia applications, such as over-the-air television broadcasts, cable television transmissions, satellite television transmissions, Internet streaming

video transmissions, such as dynamic adaptive streaming over HTTP (DASH), digital video that is encoded onto a data storage medium, decoding of digital video stored on a data storage medium, or other applications.

[0045] Input interface 122 of destination device 116 receives an encoded video bitstream from computer-readable medium 110 (e.g., storage device 112, file server 114, or the like). The encoded video bitstream from computer-readable medium 110 may include signaling information defined by video encoder 200, which is also used by video decoder 300, such as syntax elements having values that describe characteristics and/or processing of video blocks or other coded units (e.g., slices, pictures, groups of pictures, sequences, or the like). Display device 118 displays decoded pictures of the decoded video data to a user. Display device 118 may represent any of a variety of display devices such as a cathode ray tube (CRT), a liquid crystal display (LCD), a plasma display, an organic light emitting diode (OLED) display, or another type of display device.

[0046] Although not shown in FIG. 1, in some examples, video encoder 200 and video decoder 300 may each be integrated with an audio encoder and/or audio decoder, and may include appropriate MUX-DEMUX units, or other hardware and/or software, to handle multiplexed streams including both audio and video in a common data stream. If applicable, MUX-DEMUX units may conform to the ITU H.223 multiplexer protocol, or other protocols such as the user datagram protocol (UDP).

[0047] Video encoder 200 and video decoder 300 each may be implemented as any of a variety of suitable encoder and/or decoder circuitry, such as one or more microprocessors, digital signal processors (DSPs), application specific integrated circuits (ASICs), field programmable gate arrays (FPGAs), discrete logic, software, hardware, firmware or any combinations thereof. When the techniques are implemented partially in software, a device may store instructions for the software in a suitable, non-transitory computer-readable medium and execute the instructions in hardware using one or more processors to perform the techniques of this disclosure. Each of video encoder 200 and video decoder 300 may be included in one or more encoders or decoders, either of which may be integrated as part of a combined encoder/decoder (CODEC) in a respective device. A device including video encoder 200 and/or video decoder 300 may comprise an integrated circuit, a microprocessor, and/or a wireless communication device, such as a cellular telephone.

[0048] Video encoder 200 and video decoder 300 may operate according to a video coding standard, such as ITU-T H.265, also referred to as High Efficiency Video Coding (HEVC) or extensions thereto, such as the multi-view and/or scalable video coding extensions. Alternatively, video encoder 200 and video decoder 300 may operate according to other proprietary or industry standards, such as the Joint Exploration Test Model (JEM) or ITU-T H.266, also referred to as Versatile Video Coding (VVC). A recent draft of the VVC standard is described in Bross, et al. “Versatile Video Coding (Draft 7),” Joint Video Experts Team (JVET) of ITU-T SG 16 WP 3 and ISO/IEC JTC 1/SC 29/WG 11, 16th Meeting: Geneva, CH, 1–11 October 2019, JVET-P2001-v9 (hereinafter “VVC Draft 7”). The techniques of this disclosure, however, are not limited to any particular coding standard.

[0049] In general, video encoder 200 and video decoder 300 may perform block-based coding of pictures. The term “block” generally refers to a structure including data to be processed (e.g., encoded, decoded, or otherwise used in the encoding and/or decoding process). For example, a block may include a two-dimensional matrix of samples of luminance and/or chrominance data. In general, video encoder 200 and video decoder 300 may code video data represented in a YUV (e.g., Y, Cb, Cr) format. That is, rather than coding red, green, and blue (RGB) data for samples of a picture, video encoder 200 and video decoder 300 may code luminance and chrominance components, where the chrominance components may include both red hue and blue hue chrominance components. In some examples, video encoder 200 converts received RGB formatted data to a YUV representation prior to encoding, and video decoder 300 converts the YUV representation to the RGB format. Alternatively, pre-processing units and post-processing units (not shown) may perform these conversions.

[0050] YUV 4:4:4 may refer to a YUV representation where each of the three components (e.g., Y, Cb, Cr) has a same sampling rate and no chroma subsampling. For example, a luma (e.g., Y) component of YUV 4:4:4 may have a first resolution. In this example, a first chroma component (e.g., Cb) component of YUV 4:4:4 may have the first resolution of the luma component and a second chroma component (e.g., Cr) component of YUV 4:4:4 may have the first resolution of the luma component. In contrast, YUV 4:2:0 may refer to a YUV representation where each of the chroma components (e.g., Cb, Cr) has half a sampling rate of a luma component in both a vertical and horizontal direction and therefore YUV 4:2:0 may have chroma subsampling. For example, a luma (e.g., Y) component of YUV 4:4:4 may have a first

resolution. In this example, a first chroma component (e.g., Cb) component of YUV 4:4:4 may have a second resolution (e.g., vertical and horizontal) that is half of the first resolution of the luma component and a second chroma component (e.g., Cr) component of YUV 4:4:4 may have a second resolution (e.g., vertical and horizontal) that is half of the first resolution of the luma component, and the same as the second resolution of the first chroma component. While this disclosure refers to YUV 4:4:4 and YUV 4:2:0 as examples of chroma formats, other examples may use other formats (e.g., YUV 4:2:2, etc.).

[0051] This disclosure may generally refer to coding (e.g., encoding and decoding) of pictures to include the process of encoding or decoding data of the picture. Similarly, this disclosure may refer to coding of blocks of a picture to include the process of encoding or decoding data for the blocks, e.g., prediction and/or residual coding. An encoded video bitstream generally includes a series of values for syntax elements representative of coding decisions (e.g., coding modes) and partitioning of pictures into blocks. Thus, references to coding a picture or a block should generally be understood as coding values for syntax elements forming the picture or block.

[0052] HEVC defines various blocks, including coding units (CUs), prediction units (PUs), and transform units (TUs). According to HEVC, a video coder (such as video encoder 200) partitions a coding tree unit (CTU) into CUs according to a quadtree structure. That is, the video coder partitions CTUs and CUs into four equal, non-overlapping squares, and each node of the quadtree has either zero or four child nodes. Nodes without child nodes may be referred to as “leaf nodes,” and CUs of such leaf nodes may include one or more PUs and/or one or more TUs. The video coder may further partition PUs and TUs. For example, in HEVC, a residual quadtree (RQT) represents partitioning of TUs. In HEVC, PUs represent inter-prediction data, while TUs represent residual data. CUs that are intra-predicted include intra-prediction information, such as an intra-mode indication.

[0053] As another example, video encoder 200 and video decoder 300 may be configured to operate according to JEM or VVC. According to JEM or VVC, a video coder (such as video encoder 200) partitions a picture into a plurality of coding tree units (CTUs). Video encoder 200 may partition a CTU according to a tree structure, such as a quadtree-binary tree (QTBT) structure or Multi-Type Tree (MTT) structure. The QTBT structure removes the concepts of multiple partition types, such as the separation between CUs, PUs, and TUs of HEVC. A QTBT structure includes two

levels: a first level partitioned according to quadtree partitioning, and a second level partitioned according to binary tree partitioning. A root node of the QTBT structure corresponds to a CTU. Leaf nodes of the binary trees correspond to coding units (CUs).

[0054] In an MTT partitioning structure, blocks may be partitioned using a quadtree (QT) partition, a binary tree (BT) partition, and one or more types of triple tree (TT) partitions. A triple tree partition is a partition where a block is split into three sub-blocks. In some examples, a triple tree partition divides a block into three sub-blocks without dividing the original block through the center. The partitioning types in MTT (e.g., QT, BT, and TT), may be symmetrical or asymmetrical.

[0055] In some examples, video encoder 200 and video decoder 300 may use a single QTBT or MTT structure to represent each of the luminance and chrominance components, while in other examples, video encoder 200 and video decoder 300 may use two or more QTBT or MTT structures, such as one QTBT/MTT structure for the luminance component and another QTBT/MTT structure for both chrominance components (or two QTBT/MTT structures for respective chrominance components).

[0056] Video encoder 200 and video decoder 300 may be configured to use quadtree partitioning per HEVC, QTBT partitioning, MTT partitioning, or other partitioning structures. For purposes of explanation, the description of the techniques of this disclosure is presented with respect to QTBT partitioning. However, it should be understood that the techniques of this disclosure may also be applied to video coders configured to use quadtree partitioning, or other types of partitioning as well.

[0057] This disclosure may use “NxN” and “N by N” interchangeably to refer to the sample dimensions of a block (such as a CU or other video block) in terms of vertical and horizontal dimensions, e.g., 16x16 samples or 16 by 16 samples. In general, a 16x16 CU will have 16 samples in a vertical direction ($y = 16$) and 16 samples in a horizontal direction ($x = 16$). Likewise, an NxN CU generally has N samples in a vertical direction and N samples in a horizontal direction, where N represents a nonnegative integer value. The samples in a CU may be arranged in rows and columns. Moreover, CUs need not necessarily have the same number of samples in the horizontal direction as in the vertical direction. For example, CUs may comprise NxM samples, where M is not necessarily equal to N.

[0058] Video encoder 200 encodes video data for CUs representing prediction and/or residual information, and other information. The prediction information indicates how the CU is to be predicted in order to form a prediction block for the CU. The residual

information generally represents sample-by-sample differences between samples of the CU prior to encoding and the prediction block.

[0059] To predict a CU, video encoder 200 may generally form a prediction block for the CU through inter-prediction or intra-prediction. Inter-prediction generally refers to predicting the CU from data of a previously coded picture, whereas intra-prediction generally refers to predicting the CU from previously coded data of the same picture. To perform inter-prediction, video encoder 200 may generate the prediction block using one or more motion vectors. Video encoder 200 may generally perform a motion search to identify a reference block that closely matches the CU, e.g., in terms of differences between the CU and the reference block. Video encoder 200 may calculate a difference metric using a sum of absolute difference (SAD), sum of squared differences (SSD), mean absolute difference (MAD), mean squared differences (MSD), or other such difference calculations to determine whether a reference block closely matches the current CU. In some examples, video encoder 200 may predict the current CU using uni-directional prediction or bi-directional prediction.

[0060] Some examples of JEM and VVC also provide an affine motion compensation mode, which may be considered an inter-prediction mode. In affine motion compensation mode, video encoder 200 may determine two or more motion vectors that represent non-translational motion, such as zoom in or out, rotation, perspective motion, or other irregular motion types.

[0061] To perform intra-prediction, video encoder 200 may select an intra-prediction mode to generate the prediction block. Some examples of JEM and VVC provide sixty-seven intra-prediction modes, including various directional modes, as well as planar mode and DC mode. In general, video encoder 200 selects an intra-prediction mode that describes neighboring samples to a current block (e.g., a block of a CU) from which to predict samples of the current block. Such samples may generally be above, above and to the left, or to the left of the current block in the same picture as the current block, assuming video encoder 200 codes CTUs and CUs in raster scan order (left to right, top to bottom).

[0062] Video encoder 200 encodes data representing the prediction mode for a current block. For example, for inter-prediction modes, video encoder 200 may encode data representing which of the various available inter-prediction modes is used, as well as motion information for the corresponding mode. For uni-directional or bi-directional inter-prediction, for example, video encoder 200 may encode motion vectors using

advanced motion vector prediction (AMVP) or merge mode. Video encoder 200 may use similar modes to encode motion vectors for affine motion compensation mode.

[0063] Following prediction, such as intra-prediction or inter-prediction of a block, video encoder 200 may calculate residual data for the block. The residual data, such as a residual block, represents sample by sample differences between the block and a prediction block for the block, formed using the corresponding prediction mode. Video encoder 200 may apply one or more transforms to the residual block, to produce transformed data in a transform domain instead of the sample domain. For example, video encoder 200 may apply a discrete cosine transform (DCT), an integer transform, a wavelet transform, or a conceptually similar transform to residual video data. Additionally, video encoder 200 may apply a secondary transform following the first transform, such as a mode-dependent non-separable secondary transform (MDNSST), a signal dependent transform, a Karhunen-Loeve transform (KLT), or the like. Video encoder 200 produces transform coefficients following application of the one or more transforms.

[0064] As noted above, following any transforms to produce transform coefficients, video encoder 200 may perform quantization of the transform coefficients.

Quantization generally refers to a process in which transform coefficients are quantized to possibly reduce the amount of data used to represent the coefficients, providing further compression. By performing the quantization process, video encoder 200 may reduce the bit depth associated with some or all of the coefficients. For example, video encoder 200 may round an n -bit value down to an m -bit value during quantization, where n is greater than m . In some examples, to perform quantization, video encoder 200 may perform a bitwise right-shift of the value to be quantized.

[0065] Following quantization, video encoder 200 may scan the transform coefficients, producing a one-dimensional vector from the two-dimensional matrix including the quantized transform coefficients. The scan may be designed to place higher energy (and therefore lower frequency) coefficients at the front of the vector and to place lower energy (and therefore higher frequency) transform coefficients at the back of the vector. In some examples, video encoder 200 may utilize a predefined scan order to scan the quantized transform coefficients to produce a serialized vector, and then entropy encode the quantized transform coefficients of the vector. In other examples, video encoder 200 may perform an adaptive scan. After scanning the quantized transform coefficients to form the one-dimensional vector, video encoder 200 may entropy encode the one-

dimensional vector, e.g., according to context-adaptive binary arithmetic coding (CABAC). Video encoder 200 may also entropy encode values for syntax elements describing metadata associated with the encoded video data for use by video decoder 300 in decoding the video data.

[0066] To perform CABAC, video encoder 200 may assign a context within a context model to a symbol to be transmitted. The context may relate to, for example, whether neighboring values of the symbol are zero-valued or not. The probability determination may be based on a context assigned to the symbol.

[0067] Video encoder 200 may further generate syntax data, such as block-based syntax data, picture-based syntax data, and sequence-based syntax data, to video decoder 300, e.g., in a picture header, a block header, a slice header, or other syntax data, such as a sequence parameter set (SPS), picture parameter set (PPS), or video parameter set (VPS). Video decoder 300 may likewise decode such syntax data to determine how to decode corresponding video data.

[0068] In this manner, video encoder 200 may generate a bitstream including encoded video data, e.g., syntax elements describing partitioning of a picture into blocks (e.g., CUs) and prediction and/or residual information for the blocks. Ultimately, video decoder 300 may receive the bitstream and decode the encoded video data.

[0069] In general, video decoder 300 performs a reciprocal process to that performed by video encoder 200 to decode the encoded video data of the bitstream. For example, video decoder 300 may decode values for syntax elements of the bitstream using CABAC in a manner substantially similar to, albeit reciprocal to, the CABAC encoding process of video encoder 200. The syntax elements may define partitioning information of a picture into CTUs, and partitioning of each CTU according to a corresponding partition structure, such as a QTBT structure, to define CUs of the CTU. The syntax elements may further define prediction and residual information for blocks (e.g., CUs) of video data.

[0070] The residual information may be represented by, for example, quantized transform coefficients. Video decoder 300 may inverse quantize and inverse transform the quantized transform coefficients of a block to reproduce a residual block for the block. Video decoder 300 uses a signaled prediction mode (intra- or inter-prediction) and related prediction information (e.g., motion information for inter-prediction) to form a prediction block for the block. Video decoder 300 may then combine the prediction block and the residual block (on a sample-by-sample basis) to reproduce the original

block. That is, for example, video decoder 300 may combine the predicted block and the residual block to decode an unfiltered reconstructed block for the block of video data. In some examples, video decoder 300 may store the unfiltered reconstructed block at DPB 314. Video decoder 300 may perform additional processing, such as performing a deblocking process to reduce visual artifacts along boundaries of the block. That is, for example, video decoder 300 may generate a filtered reconstructed block for the block of video data, where generating the filtered reconstructed block comprises performing one or more filter operations on the unfiltered reconstructed block. In this example, video decoder 300 may store the filtered reconstructed block at DPB 314.

[0071] In accordance with the techniques of this disclosure, video encoder 200 and/or video decoder 300 may be configured to generate a coding unit for a chroma component of a block of video data in a YUV 4:4:4 format or in a YUV 4:2:0 format. In this example, video encoder 200 or video decoder 300 may be configured to split the coding unit for the chroma component into a first triangle-shaped partition and a second triangle-shaped partition based on enabling of a triangular prediction unit mode. Video encoder 200 or video decoder 300 may be configured to apply pixel blending using a set of weights for the YUV 4:2:0 format to generate a predicted block for the chroma component when the one or more processors generate the coding unit for the chroma component in the YUV 4:2:0 format and when the one or more processors generate the coding unit for the chroma component in the YUV 4:4:4 format. Using a single set of weights for generating coding unit for a chroma component in the YUV 4:2:0 format and in the YUV 4:4:4 format may reduce a complexity of decoding video data, which may reduce an amount of time video encoder 200 and video decoder 300 decode video data and/or reduce a power consumption of video encoder 200 and video decoder 300.

[0072] To apply pixel blending, video encoder 200 or video decoder 300 may be configured to determine weighted averages, using the set of weights for the YUV 4:2:0 format, of collocated motion compensated pixels of the first triangle-shaped partition and the second triangle-shaped partition based on motion information of the first triangle-shaped partition and the second triangle-shaped partition, respectively.

[0073] In some examples, video encoder 200 and/or video decoder 300 may be configured to obtain unfiltered reference samples for an area of a picture. In this example, video encoder 200 and/or video decoder 300 may be configured to disable intra-reference sample smoothing of the unfiltered reference samples for chroma samples in a YUV 4:2:0 format and in a YUV 4:4:4 format. Video encoder 200 and/or

video decoder 300 may be configured to generate, using intra-prediction, chroma samples of a prediction block for a block of the picture based on the unfiltered reference samples when generating the chroma components in the YUV 4:2:0 format and when generating the chroma components in the YUV 4:4:4 format. Disabling intra-reference sample smoothing of the unfiltered reference samples for chroma samples in a YUV 4:2:0 format and in a YUV 4:4:4 format may reduce a complexity of decoding video data, which may reduce an amount of time video encoder 200 and video decoder 300 decode video data and/or reduce a power consumption of video encoder 200 and video decoder 300.

[0074] This disclosure may generally refer to “signaling” certain information, such as syntax elements. The term “signaling” may generally refer to the communication of values syntax elements and/or other data used to decode encoded video data. That is, video encoder 200 may signal values for syntax elements in the bitstream. In general, signaling refers to generating a value in the bitstream. As noted above, source device 102 may transport the bitstream to destination device 116 substantially in real time, or not in real time, such as might occur when storing syntax elements to storage device 112 for later retrieval by destination device 116.

[0075] FIGS. 2A and 2B are conceptual diagram illustrating an example quadtree binary tree (QTBT) structure 130, and a corresponding coding tree unit (CTU) 132. The solid lines represent quadtree splitting, and dotted lines indicate binary tree splitting. In each split (i.e., non-leaf) node of the binary tree, one flag is signaled to indicate which splitting type (i.e., horizontal or vertical) is used, where 0 indicates horizontal splitting and 1 indicates vertical splitting in this example. For the quadtree splitting, there is no need to indicate the splitting type, since quadtree nodes split a block horizontally and vertically into 4 sub-blocks with equal size. Accordingly, video encoder 200 may encode, and video decoder 300 may decode, syntax elements (such as splitting information) for a region tree level of QTBT structure 130 (i.e., the solid lines) and syntax elements (such as splitting information) for a prediction tree level of QTBT structure 130 (i.e., the dashed lines). Video encoder 200 may encode, and video decoder 300 may decode, video data, such as prediction and transform data, for CUs represented by terminal leaf nodes of QTBT structure 130.

[0076] In general, CTU 132 of FIG. 2B may be associated with parameters defining sizes of blocks corresponding to nodes of QTBT structure 130 at the first and second levels. These parameters may include a CTU size (representing a size of CTU 132 in

samples), a minimum quadtree size (MinQTSIZE, representing a minimum allowed quadtree leaf node size), a maximum binary tree size (MaxBTSIZE, representing a maximum allowed binary tree root node size), a maximum binary tree depth (MaxBTDEPTH, representing a maximum allowed binary tree depth), and a minimum binary tree size (MinBTSIZE, representing the minimum allowed binary tree leaf node size).

[0077] The root node of a QTBT structure corresponding to a CTU may have four child nodes at the first level of the QTBT structure, each of which may be partitioned according to quadtree partitioning. That is, nodes of the first level are either leaf nodes (having no child nodes) or have four child nodes. The example of QTBT structure 130 represents such nodes as including the parent node and child nodes having solid lines for branches. If nodes of the first level are not larger than the maximum allowed binary tree root node size (MaxBTSIZE), they can be further partitioned by respective binary trees. The binary tree splitting of one node can be iterated until the nodes resulting from the split reach the minimum allowed binary tree leaf node size (MinBTSIZE) or the maximum allowed binary tree depth (MaxBTDEPTH). The example of QTBT structure 130 represents such nodes as having dashed lines for branches. The binary tree leaf node is referred to as a coding unit (CU), which is used for prediction (e.g., intra-picture or inter-picture prediction) and transform, without any further partitioning. As discussed above, CUs may also be referred to as “video blocks” or “blocks.”

[0078] In one example of the QTBT partitioning structure, the CTU size is set as 128x128 (luma samples and two corresponding 64x64 chroma samples), the MinQTSIZE is set as 16x16, the MaxBTSIZE is set as 64x64, the MinBTSIZE (for both width and height) is set as 4, and the MaxBTDEPTH is set as 4. The quadtree partitioning is applied to the CTU first to generate quad-tree leaf nodes. The quadtree leaf nodes may have a size from 16x16 (i.e., the MinQTSIZE) to 128x128 (i.e., the CTU size). If the leaf quadtree node is 128x128, it will not be further split by the binary tree, since the size exceeds the MaxBTSIZE (i.e., 64x64, in this example). Otherwise, the leaf quadtree node will be further partitioned by the binary tree. Therefore, the quadtree leaf node is also the root node for the binary tree and has the binary tree depth as 0. When the binary tree depth reaches MaxBTDEPTH (4, in this example), no further splitting is permitted. When the binary tree node has width equal to MinBTSIZE (4, in this example), it implies no further horizontal splitting is permitted. Similarly, a binary tree node having a height equal to MinBTSIZE implies no further vertical splitting is

permitted for that binary tree node. As noted above, leaf nodes of the binary tree are referred to as CUs and are further processed according to prediction and transform without further partitioning.

[0079] FIG. 3 is a block diagram illustrating an example video encoder 200 that may perform the techniques of this disclosure. FIG. 3 is provided for purposes of explanation and should not be considered limiting of the techniques as broadly exemplified and described in this disclosure. For purposes of explanation, this disclosure describes video encoder 200 in the context of video coding standards such as the HEVC video coding standard and the JEM, VVC (ITU-T H.266) video coding standard in development. However, the techniques of this disclosure are not limited to these video coding standards, and are applicable generally to video encoding and decoding.

[0080] In the example of FIG. 3, video encoder 200 includes video data memory 230, mode selection unit 202, residual generation unit 204, transform processing unit 206, quantization unit 208, inverse quantization unit 210, inverse transform processing unit 212, reconstruction unit 214, filter unit 216, decoded picture buffer (DPB) 218, and entropy encoding unit 220. Any or all of video data memory 230, mode selection unit 202, residual generation unit 204, transform processing unit 206, quantization unit 208, inverse quantization unit 210, inverse transform processing unit 212, reconstruction unit 214, filter unit 216, DPB 218, and entropy encoding unit 220 may be implemented in one or more processors or in processing circuitry. For instance, the units of video encoder 200 may be implemented as one or more circuits or logic elements forming part of a processor, ASIC, or FPGA. Moreover, video encoder 200 may include additional or alternative processors or processing circuitry to perform these and other functions.

[0081] Video data memory 230 may store video data to be encoded by the components of video encoder 200. Video encoder 200 may receive the video data stored in video data memory 230 from, for example, video source 104 (FIG. 1). DPB 218 may act as a reference picture memory that stores reference video data for use in prediction of subsequent video data by video encoder 200. Video data memory 230 and DPB 218 may be formed by any of a variety of memory devices, such as dynamic random access memory (DRAM), including synchronous DRAM (SDRAM), magnetoresistive RAM (MRAM), resistive RAM (RRAM), or other types of memory devices. Video data memory 230 and DPB 218 may be provided by the same memory device or separate memory devices. In various examples, video data memory 230 may be on-chip with

other components of video encoder 200, as illustrated, or off-chip relative to those components.

[0082] In this disclosure, reference to video data memory 230 should not be interpreted as being limited to memory internal to video encoder 200, unless specifically described as such, or memory external to video encoder 200, unless specifically described as such. Rather, reference to video data memory 230 should be understood as reference memory that stores video data that video encoder 200 receives for encoding (e.g., video data for a current block that is to be encoded). Memory 106 of FIG. 1 may also provide temporary storage of outputs from the various units of video encoder 200.

[0083] The various units of FIG. 3 are illustrated to assist with understanding the operations performed by video encoder 200. The units may be implemented as fixed-function circuits, programmable circuits, or a combination thereof. Fixed-function circuits refer to circuits that provide particular functionality, and are preset on the operations that can be performed. Programmable circuits refer to circuits that can be programmed to perform various tasks, and provide flexible functionality in the operations that can be performed. For instance, programmable circuits may execute software or firmware that cause the programmable circuits to operate in the manner defined by instructions of the software or firmware. Fixed-function circuits may execute software instructions (e.g., to receive parameters or output parameters), but the types of operations that the fixed-function circuits perform are generally immutable. In some examples, the one or more of the units may be distinct circuit blocks (fixed-function or programmable), and in some examples, the one or more units may be integrated circuits.

[0084] Video encoder 200 may include arithmetic logic units (ALUs), elementary function units (EFUs), digital circuits, analog circuits, and/or programmable cores, formed from programmable circuits. In examples where the operations of video encoder 200 are performed using software executed by the programmable circuits, memory 106 (FIG. 1) may store the object code of the software that video encoder 200 receives and executes, or another memory within video encoder 200 (not shown) may store such instructions.

[0085] Video data memory 230 is configured to store received video data. Video encoder 200 may retrieve a picture of the video data from video data memory 230 and provide the video data to residual generation unit 204 and mode selection unit 202. Video data in video data memory 230 may be raw video data that is to be encoded.

[0086] Mode selection unit 202 includes a motion estimation unit 222, motion compensation unit 224, and an intra-prediction unit 226. Mode selection unit 202 may include additional functional units to perform video prediction in accordance with other prediction modes. As examples, mode selection unit 202 may include a palette unit, an intra-block copy unit (which may be part of motion estimation unit 222 and/or motion compensation unit 224), an affine unit, a linear model (LM) unit, or the like.

[0087] Mode selection unit 202 generally coordinates multiple encoding passes to test combinations of encoding parameters and resulting rate-distortion values for such combinations. The encoding parameters may include partitioning of CTUs into CUs, prediction modes for the CUs, transform types for residual data of the CUs, quantization parameters for residual data of the CUs, and so on. Mode selection unit 202 may ultimately select the combination of encoding parameters having rate-distortion values that are better than the other tested combinations.

[0088] Video encoder 200 may partition a picture retrieved from video data memory 230 into a series of CTUs, and encapsulate one or more CTUs within a slice. Mode selection unit 202 may partition a CTU of the picture in accordance with a tree structure, such as the QTBT structure or the quad-tree structure of HEVC described above. As described above, video encoder 200 may form one or more CUs from partitioning a CTU according to the tree structure. Such a CU may also be referred to generally as a “video block” or “block.”

[0089] In some examples, mode selection unit 202 may be configured to generate a coding unit for a chroma component of a block of video data in a YUV 4:4:4 format or in a YUV 4:2:0 format. In this example, mode selection unit 202 may be configured to split the coding unit for the chroma component into a first triangle-shaped partition and a second triangle-shaped partition based on enabling of a triangular prediction unit mode. Mode selection unit 202 may be configured to apply pixel blending using a set of weights for the YUV 4:2:0 format to generate a predicted block for the chroma component when the one or more processors generate the coding unit for the chroma component in the YUV 4:2:0 format and when the one or more processors generate the coding unit for the chroma component in the YUV 4:4:4 format. In this way, mode selection unit 202 may use a set of weights for both the YUV 4:2:0 format and the YUV 4:4:4 format, which may help to unify treatment of different chroma formats. Unifying treatment of different chroma formats may help to reduce codec processing overhead.

[0090] To apply pixel blending, mode selection unit 202 may be configured to determine weighted averages, using the set of weights for the YUV 4:2:0 format, of collocated motion compensated pixels of the first triangle-shaped partition and the second triangle-shaped partition based on motion information of the first triangle-shaped partition and the second triangle-shaped partition. An example process of determining weighted averages is explained in further detail below (e.g., see FIGS. 7A-7C).

[0091] In general, in some examples, mode selection unit 202 also controls the components thereof (e.g., motion estimation unit 222, motion compensation unit 224, and intra-prediction unit 226) to generate a prediction block for a current block (e.g., a current CU, or in HEVC, the overlapping portion of a PU and a TU). For inter-prediction of a current block, motion estimation unit 222 may perform a motion search to identify one or more closely matching reference blocks in one or more reference pictures (e.g., one or more previously coded pictures stored in DPB 218). In particular, motion estimation unit 222 may calculate a value representative of how similar a potential reference block is to the current block, e.g., according to sum of absolute difference (SAD), sum of squared differences (SSD), mean absolute difference (MAD), mean squared differences (MSD), or the like. Motion estimation unit 222 may generally perform these calculations using sample-by-sample differences between the current block and the reference block being considered. Motion estimation unit 222 may identify a reference block having a lowest value resulting from these calculations, indicating a reference block that most closely matches the current block.

[0092] Motion estimation unit 222 may form one or more motion vectors (MVs) that define the positions of the reference blocks in the reference pictures relative to the position of the current block in a current picture. Motion estimation unit 222 may then provide the motion vectors to motion compensation unit 224. For example, for uni-directional inter-prediction, motion estimation unit 222 may provide a single motion vector, whereas for bi-directional inter-prediction, motion estimation unit 222 may provide two motion vectors. Motion compensation unit 224 may then generate a prediction block using the motion vectors. For example, motion compensation unit 224 may retrieve data of the reference block using the motion vector. As another example, if the motion vector has fractional sample precision, motion compensation unit 224 may interpolate values for the prediction block according to one or more interpolation filters. Moreover, for bi-directional inter-prediction, motion compensation unit 224 may

retrieve data for two reference blocks identified by respective motion vectors and combine the retrieved data, e.g., through sample-by-sample averaging or weighted averaging.

[0093] As another example, for intra-prediction, or intra-prediction coding, intra-prediction unit 226 may generate the prediction block from samples neighboring the current block. For example, for directional modes, intra-prediction unit 226 may generally mathematically combine values of neighboring samples and populate these calculated values in the defined direction across the current block to produce the prediction block. As another example, for DC mode, intra-prediction unit 226 may calculate an average of the neighboring samples to the current block and generate the prediction block to include this resulting average for each sample of the prediction block.

[0094] Intra-prediction unit 226 may be configured to obtain unfiltered reference samples for an area of a picture. Intra-prediction unit 226 may be configured to disable intra-reference sample smoothing of the unfiltered reference samples for chroma samples in a YUV 4:2:0 format and in a YUV 4:4:4 format. When intra-reference sample smoothing is disabled, intra-prediction unit 226 may use only unfiltered reference samples for chroma samples. Intra-prediction unit 226 may be configured to generate, using intra-prediction, chroma samples of a prediction block for a block of the picture based on the unfiltered reference samples when generating the chroma components in the YUV 4:2:0 format and when generating the chroma components in the YUV 4:4:4 format. That is, for example, for chroma components in both the YUV 4:4:4 format and the YUV 4:4:4 format, intra-prediction unit 226 may use only unfiltered reference samples for chroma samples. In this way, a complexity of encoding and decoding video data may be reduced, which may reduce an amount of time intra-prediction unit 226 codes (e.g, encoders or decodes) video data and/or reduce a power consumption of intra-prediction unit 226.

[0095] Techniques described herein for disabling intra-reference sample smoothing of the unfiltered reference samples for chroma samples may be used in combination with or separately from techniques described herein for generating a coding unit for chroma components in the YUV 4:2:0 format. For example, intra-prediction unit 226 may be configured to obtain unfiltered reference samples for an area of a picture in combination with mode selection unit 202 generating a coding unit for chroma components of a block of video data in a YUV 4:4:4 format or in a YUV 4:2:0 format. In some

examples, intra-prediction unit 226 may be configured to obtain unfiltered reference samples for an area of a picture in combination and mode selection unit 202 refrains from generating a coding unit for chroma components of a block of video data in a YUV 4:4:4 format or in a YUV 4:2:0 format.

[0096] Mode selection unit 202 provides the prediction block to residual generation unit 204. Residual generation unit 204 receives a raw, uncoded version of the current block from video data memory 230 and the prediction block from mode selection unit 202. Residual generation unit 204 calculates sample-by-sample differences between the current block and the prediction block. The resulting sample-by-sample differences define a residual block for the current block. In some examples, residual generation unit 204 may also determine differences between sample values in the residual block to generate a residual block using residual differential pulse code modulation (RDPCM). In some examples, residual generation unit 204 may be formed using one or more subtractor circuits that perform binary subtraction.

[0097] In examples where mode selection unit 202 partitions CUs into PUs, each PU may be associated with a luma prediction unit and corresponding chroma prediction units. Video encoder 200 and video decoder 300 may support PUs having various sizes. As indicated above, the size of a CU may refer to the size of the luma coding block of the CU and the size of a PU may refer to the size of a luma prediction unit of the PU. Assuming that the size of a particular CU is $2N \times 2N$, video encoder 200 may support PU sizes of $2N \times 2N$ or $N \times N$ for intra prediction, and symmetric PU sizes of $2N \times 2N$, $2N \times N$, $N \times 2N$, $N \times N$, or similar for inter prediction. Video encoder 200 and video decoder 300 may also support asymmetric partitioning for PU sizes of $2N \times nU$, $2N \times nD$, $nL \times 2N$, and $nR \times 2N$ for inter prediction.

[0098] In examples where mode selection unit does not further partition a CU into PUs, each CU may be associated with a luma coding block and corresponding chroma coding blocks. As above, the size of a CU may refer to the size of the luma coding block of the CU. The video encoder 200 and video decoder 120 may support CU sizes of $2N \times 2N$, $2N \times N$, or $N \times 2N$.

[0099] For other video coding techniques such as an intra-block copy mode coding, an affine-mode coding, and linear model (LM) mode coding, as few examples, mode selection unit 202, via respective units associated with the coding techniques, generates a prediction block for the current block being encoded. In some examples, such as palette mode coding, mode selection unit 202 may not generate a prediction block, and

instead generate syntax elements that indicate the manner in which to reconstruct the block based on a selected palette. In such modes, mode selection unit 202 may provide these syntax elements to entropy encoding unit 220 to be encoded.

[0100] As described above, residual generation unit 204 receives the video data for the current block and the corresponding prediction block. Residual generation unit 204 then generates a residual block for the current block. To generate the residual block, residual generation unit 204 calculates sample-by-sample differences between the prediction block and the current block.

[0101] Transform processing unit 206 applies one or more transforms to the residual block to generate a block of transform coefficients (referred to herein as a “transform coefficient block”). Transform processing unit 206 may apply various transforms to a residual block to form the transform coefficient block. For example, transform processing unit 206 may apply a discrete cosine transform (DCT), a directional transform, a Karhunen-Loeve transform (KLT), or a conceptually similar transform to a residual block. In some examples, transform processing unit 206 may perform multiple transforms to a residual block, e.g., a primary transform and a secondary transform, such as a rotational transform. In some examples, transform processing unit 206 does not apply transforms to a residual block.

[0102] Quantization unit 208 may quantize the transform coefficients in a transform coefficient block, to produce a quantized transform coefficient block. Quantization unit 208 may quantize transform coefficients of a transform coefficient block according to a quantization parameter (QP) value associated with the current block. Video encoder 200 (e.g., via mode selection unit 202) may adjust the degree of quantization applied to the coefficient blocks associated with the current block by adjusting the QP value associated with the CU. Quantization may introduce loss of information, and thus, quantized transform coefficients may have lower precision than the original transform coefficients produced by transform processing unit 206.

[0103] Inverse quantization unit 210 and inverse transform processing unit 212 may apply inverse quantization and inverse transforms to a quantized transform coefficient block, respectively, to reconstruct a residual block from the transform coefficient block. Reconstruction unit 214 may produce a reconstructed block corresponding to the current block (albeit potentially with some degree of distortion) based on the reconstructed residual block and a prediction block generated by mode selection unit 202. For example, reconstruction unit 214 may add samples of the reconstructed residual block to

corresponding samples from the prediction block generated by mode selection unit 202 to produce the reconstructed block. That is, for example, reconstruction unit 214 may combine the predicted block and the residual block to decode an unfiltered reconstructed block for the block of video data. In some examples, reconstruction unit 214 may store the unfiltered reconstructed block at DPB 218.

[0104] Filter unit 216 may perform one or more filter operations on reconstructed blocks. For example, filter unit 216 may perform deblocking operations to reduce blockiness artifacts along edges of CUs. Operations of filter unit 216 may be skipped, in some examples. That is, for example, filter unit 216 may generate a filtered reconstructed block for the block of video data, where generating the filtered reconstructed block comprises performing one or more filter operations on the unfiltered reconstructed block. In this example, filter unit 216 may store the filtered reconstructed block at DPB 218.

[0105] Video encoder 200 stores reconstructed blocks in DPB 218. For instance, in examples where operations of filter unit 216 are not needed, reconstruction unit 214 may store reconstructed blocks to DPB 218. In examples where operations of filter unit 216 are needed, filter unit 216 may store the filtered reconstructed blocks to DPB 218. Motion estimation unit 222 and motion compensation unit 224 may retrieve a reference picture from DPB 218, formed from the reconstructed (and potentially filtered) blocks, to inter-predict blocks of subsequently encoded pictures. In addition, intra-prediction unit 226 may use reconstructed blocks in DPB 218 of a current picture to intra-predict other blocks in the current picture.

[0106] In general, entropy encoding unit 220 may entropy encode syntax elements received from other functional components of video encoder 200. For example, entropy encoding unit 220 may entropy encode quantized transform coefficient blocks from quantization unit 208. As another example, entropy encoding unit 220 may entropy encode prediction syntax elements (e.g., motion information for inter-prediction or intra-mode information for intra-prediction) from mode selection unit 202. Entropy encoding unit 220 may perform one or more entropy encoding operations on the syntax elements, which are another example of video data, to generate entropy-encoded data. For example, entropy encoding unit 220 may perform a context-adaptive variable length coding (CAVLC) operation, a CABAC operation, a variable-to-variable (V2V) length coding operation, a syntax-based context-adaptive binary arithmetic coding (SBAC) operation, a Probability Interval Partitioning Entropy (PIPE) coding operation, an

Exponential-Golomb encoding operation, or another type of entropy encoding operation on the data. In some examples, entropy encoding unit 220 may operate in bypass mode where syntax elements are not entropy encoded.

[0107] Video encoder 200 may output a bitstream that includes the entropy encoded syntax elements needed to reconstruct blocks of a slice or picture. In particular, entropy encoding unit 220 may output the bitstream.

[0108] The operations described above are described with respect to a block. Such description should be understood as being operations for a luma coding block and/or chroma coding blocks. As described above, in some examples, the luma coding block and chroma coding blocks are luma and chroma components of a CU. In some examples, the luma coding block and the chroma coding blocks are luma and chroma components of a PU.

[0109] In some examples, operations performed with respect to a luma coding block need not be repeated for the chroma coding blocks. As one example, operations to identify a motion vector (MV) and reference picture for a luma coding block need not be repeated for identifying a MV and reference picture for the chroma blocks. Rather, the MV for the luma coding block may be scaled to determine the MV for the chroma blocks, and the reference picture may be the same. As another example, the intra-prediction process may be the same for the luma coding blocks and the chroma coding blocks.

[0110] Video encoder 200 represents an example of a device configured to encode video data including a memory configured to store video data, and one or more processors implemented in circuitry and configured to generate a coding unit for a chroma component of a block of video data in a YUV 4:4:4 format or in a YUV 4:2:0 format. In this example, video encoder 200 may be configured to split the coding unit for the chroma component into a first triangle-shaped partition and a second triangle-shaped partition based on enabling of a triangular prediction unit mode. Video encoder 200 may be configured to apply pixel blending using a set of weights for the YUV 4:2:0 format to generate a predicted block for the chroma component when the one or more processors generate the coding unit for the chroma component in the YUV 4:2:0 format and when the one or more processors generate the coding unit for the chroma component in the YUV 4:4:4 format. Hence, video encoder 200 may use a set of weights for both the YUV 4:2:0 format and the YUV 4:4:4 format, which may help to unify treatment of different chroma formats. Unifying treatment of different chroma

formats may help to reduce codec processing overhead. To apply pixel blending, video encoder 200 may be configured to determine weighted averages, using the set of weights for the YUV 4:2:0 format, of collocated motion compensated pixels of the first triangle-shaped partition and the second triangle-shaped partition based on motion information of the first triangle-shaped partition and the second triangle-shaped partition, respectively.

[0111] In some examples, video encoder 200 represents an example of a device configured to encode video data including a memory configured to store video data, and one or more processors implemented in circuitry and configured to obtain unfiltered reference samples for an area of a picture. In this example, video encoder 200 may be configured to disable intra-reference sample smoothing of the unfiltered reference samples for chroma samples in a YUV 4:2:0 format and in a YUV 4:4:4 format. Video encoder 200 may be configured to generate, using intra-prediction, chroma samples of a prediction block for a block of the picture based on the unfiltered reference samples when generating the chroma components in the YUV 4:2:0 format and when generating the chroma components in the YUV 4:4:4 format. That is, for example, for chroma components in both the YUV 4:4:4 format and the YUV 4:4:4 format, video encoder 200 may use only unfiltered reference samples for chroma samples. In this way, a complexity of encoding and decoding video data may be reduced, which may reduce an amount of time video encoder 200 codes (e.g, encodes or decodes) video data and/or reduce a power consumption of video encoder 200. Techniques described herein for disabling intra-reference sample smoothing of the unfiltered reference samples for chroma samples may be used in combination with or separately from techniques described herein for generating a coding unit for chroma components in the YUV 4:2:0 format.

[0112] FIG. 4 is a block diagram illustrating an example video decoder 300 that may perform the techniques of this disclosure. FIG. 4 is provided for purposes of explanation and is not limiting on the techniques as broadly exemplified and described in this disclosure. For purposes of explanation, this disclosure describes video decoder 300 is described according to the techniques of JEM, VVC (ITU-T H.266 under development), and HEVC. However, the techniques of this disclosure may be performed by video coding devices that are configured to other video coding standards.

[0113] In the example of FIG. 4, video decoder 300 includes coded picture buffer (CPB) memory 320, entropy decoding unit 302, prediction processing unit 304, inverse

quantization unit 306, inverse transform processing unit 308, reconstruction unit 310, filter unit 312, and decoded picture buffer (DPB) 314. Any or all of CPB memory 320, entropy decoding unit 302, prediction processing unit 304, inverse quantization unit 306, inverse transform processing unit 308, reconstruction unit 310, filter unit 312, and DPB 314 may be implemented in one or more processors or in processing circuitry. Moreover, video decoder 300 may include additional or alternative processors or processing circuitry to perform these and other functions.

[0114] Prediction processing unit 304 includes motion compensation unit 316 and intra-prediction unit 318. Prediction processing unit 304 may include addition units to perform prediction in accordance with other prediction modes. As examples, prediction processing unit 304 may include a palette unit, an intra-block copy unit (which may form part of motion compensation unit 318), an affine unit, a linear model (LM) unit, or the like. In other examples, video decoder 300 may include more, fewer, or different functional components.

[0115] CPB memory 320 may store video data, such as an encoded video bitstream, to be decoded by the components of video decoder 300. The video data stored in CPB memory 320 may be obtained, for example, from computer-readable medium 110 (FIG. 1). CPB memory 320 may include a CPB that stores encoded video data (e.g., syntax elements) from an encoded video bitstream. Also, CPB memory 320 may store video data other than syntax elements of a coded picture, such as temporary data representing outputs from the various units of video decoder 300. DPB 314 generally stores decoded pictures, which video decoder 300 may output and/or use as reference video data when decoding subsequent data or pictures of the encoded video bitstream. CPB memory 320 and DPB 314 may be formed by any of a variety of memory devices, such as dynamic random access memory (DRAM), including synchronous DRAM (SDRAM), magnetoresistive RAM (MRAM), resistive RAM (RRAM), or other types of memory devices. CPB memory 320 and DPB 314 may be provided by the same memory device or separate memory devices. In various examples, CPB memory 320 may be on-chip with other components of video decoder 300, or off-chip relative to those components.

[0116] Additionally or alternatively, in some examples, video decoder 300 may retrieve coded video data from memory 120 (FIG. 1). That is, memory 120 may store data as discussed above with CPB memory 320. Likewise, memory 120 may store instructions to be executed by video decoder 300, when some or all of the functionality of video

decoder 300 is implemented in software to be executed by processing circuitry of video decoder 300.

[0117] The various units shown in FIG. 4 are illustrated to assist with understanding the operations performed by video decoder 300. The units may be implemented as fixed-function circuits, programmable circuits, or a combination thereof. Similar to FIG. 3, fixed-function circuits refer to circuits that provide particular functionality, and are preset on the operations that can be performed. Programmable circuits refer to circuits that can be programmed to perform various tasks, and provide flexible functionality in the operations that can be performed. For instance, programmable circuits may execute software or firmware that cause the programmable circuits to operate in the manner defined by instructions of the software or firmware. Fixed-function circuits may execute software instructions (e.g., to receive parameters or output parameters), but the types of operations that the fixed-function circuits perform are generally immutable. In some examples, the one or more of the units may be distinct circuit blocks (fixed-function or programmable), and in some examples, the one or more units may be integrated circuits.

[0118] Video decoder 300 may include ALUs, EFUs, digital circuits, analog circuits, and/or programmable cores formed from programmable circuits. In examples where the operations of video decoder 300 are performed by software executing on the programmable circuits, on-chip or off-chip memory may store instructions (e.g., object code) of the software that video decoder 300 receives and executes.

[0119] Entropy decoding unit 302 may receive encoded video data from the CPB and entropy decode the video data to reproduce syntax elements. Prediction processing unit 304, inverse quantization unit 306, inverse transform processing unit 308, reconstruction unit 310, and filter unit 312 may generate decoded video data based on the syntax elements extracted from the bitstream.

[0120] In general, video decoder 300 reconstructs a picture on a block-by-block basis. Video decoder 300 may perform a reconstruction operation on each block individually (where the block currently being reconstructed, i.e., decoded, may be referred to as a “current block”).

[0121] Entropy decoding unit 302 may entropy decode syntax elements defining quantized transform coefficients of a quantized transform coefficient block, as well as transform information, such as a quantization parameter (QP) and/or transform mode indication(s). Inverse quantization unit 306 may use the QP associated with the

quantized transform coefficient block to determine a degree of quantization and, likewise, a degree of inverse quantization for inverse quantization unit 306 to apply. Inverse quantization unit 306 may, for example, perform a bitwise left-shift operation to inverse quantize the quantized transform coefficients. Inverse quantization unit 306 may thereby form a transform coefficient block including transform coefficients.

[0122] After inverse quantization unit 306 forms the transform coefficient block, inverse transform processing unit 308 may apply one or more inverse transforms to the transform coefficient block to generate a residual block associated with the current block. For example, inverse transform processing unit 308 may apply an inverse DCT, an inverse integer transform, an inverse Karhunen-Loeve transform (KLT), an inverse rotational transform, an inverse directional transform, or another inverse transform to the coefficient block.

[0123] Furthermore, prediction processing unit 304 generates a prediction block according to prediction information syntax elements that were entropy decoded by entropy decoding unit 302. For example, if the prediction information syntax elements indicate that the current block is inter-predicted, motion compensation unit 316 may generate the prediction block. In this case, the prediction information syntax elements may indicate a reference picture in DPB 314 from which to retrieve a reference block, as well as a motion vector identifying a location of the reference block in the reference picture relative to the location of the current block in the current picture. Motion compensation unit 316 may generally perform the inter-prediction process in a manner that is substantially similar to that described with respect to motion compensation unit 224 (FIG. 3).

[0124] In some examples, prediction processing unit 304 may be configured to generate a coding unit for a chroma component of a block of video data in a YUV 4:4:4 format or in a YUV 4:2:0 format. In this example, prediction processing unit 304 may be configured to split the coding unit for the chroma component into a first triangle-shaped partition and a second triangle-shaped partition based on enabling of a triangular prediction unit mode. Prediction processing unit 304 may be configured to apply pixel blending using a set of weights for the YUV 4:2:0 format to generate a predicted block for the chroma component when prediction processing unit 304 generates the coding unit for chroma components in the YUV 4:2:0 format and when prediction processing unit 304 generates the coding unit for chroma components in the YUV 4:4:4 format. In this way, prediction processing unit 304 may use a set of weights for both the YUV

4:2:0 format and the YUV 4:4:4 format, which may help to unify treatment of different chroma formats. Unifying treatment of different chroma formats may help to reduce codec processing overhead.

[0125] To apply pixel blending, prediction processing unit 304 may be configured to determine weighted averages, using the set of weights for the YUV 4:2:0 format, of collocated motion compensated pixels of the first triangle-shaped partition and the second triangle-shaped partition based on motion information of the first triangle-shaped partition and the second triangle-shaped partition, respectively. An example process of determining weighted averages is explained in further detail below (e.g., see FIGS. 7A-7C).

[0126] If the prediction information syntax elements indicate that the current block is intra-predicted, intra-prediction unit 318 may generate the prediction block according to an intra-prediction mode indicated by the prediction information syntax elements. Again, intra-prediction unit 318 may generally perform the intra-prediction process in a manner that is substantially similar to that described with respect to intra-prediction unit 226 (FIG. 3). Intra-prediction unit 318 may retrieve data of neighboring samples to the current block from DPB 314.

[0127] In some examples, intra-prediction unit 318 may be configured to obtain unfiltered reference samples for an area of a picture. In this example, intra-prediction unit 318 may be configured to disable intra-reference sample smoothing of the unfiltered reference samples for chroma samples in a YUV 4:2:0 format and in a YUV 4:4:4 format. When intra-reference sample smoothing is disabled, intra-prediction unit 318 may use only unfiltered reference samples for chroma samples. Intra-prediction unit 318 may be configured to generate, using intra-prediction, chroma samples of a prediction block for a block of the picture based on the unfiltered reference samples when generating the chroma components in the YUV 4:2:0 format and when generating the chroma components in the YUV 4:4:4 format. That is, for example, for chroma components in both the YUV 4:4:4 format and the YUV 4:4:4 format, intra-prediction unit 318 may use only unfiltered reference samples for chroma samples. In this way, a complexity of encoding and decoding video data may be reduced, which may reduce an amount of time intra-prediction unit 318 codes (e.g, encoders or decodes) video data and/or reduce a power consumption of intra-prediction unit 318.

[0128] Techniques described herein for disabling intra-reference sample smoothing of the unfiltered reference samples for chroma samples may be used in combination with

or separately from techniques described herein for generating a coding unit for chroma components in the YUV 4:2:0 format. For example, intra-prediction unit 318 may be configured to obtain unfiltered reference samples for an area of a picture in combination with prediction processing unit 304 generating a coding unit for chroma components of a block of video data in a YUV 4:4:4 format or in a YUV 4:2:0 format. In some examples, intra-prediction unit 318 may be configured to obtain unfiltered reference samples for an area of a picture in combination and prediction processing unit 304 refrains from generating a coding unit for chroma components of a block of video data in a YUV 4:4:4 format or in a YUV 4:2:0 format.

[0129] Reconstruction unit 310 may reconstruct the current block using the prediction block and the residual block. For example, reconstruction unit 310 may add samples of the residual block to corresponding samples of the prediction block to reconstruct the current block.

[0130] Filter unit 312 may perform one or more filter operations on reconstructed blocks. For example, filter unit 312 may perform deblocking operations to reduce blockiness artifacts along edges of the reconstructed blocks. Operations of filter unit 312 are not necessarily performed in all examples.

[0131] Video decoder 300 may store the reconstructed blocks in DPB 314. As discussed above, DPB 314 may provide reference information, such as samples of a current picture for intra-prediction and previously decoded pictures for subsequent motion compensation, to prediction processing unit 304. Moreover, video decoder 300 may output decoded pictures from DPB for subsequent presentation on a display device, such as display device 118 of FIG. 1.

[0132] In some examples, video decoder 300 represents an example of a device configured to encode video data including a memory configured to store video data, and one or more processors implemented in circuitry and configured to generate a coding unit for a chroma component of a block of video data in a YUV 4:4:4 format or in a YUV 4:2:0 format. In this example, video decoder 300 may be configured to split the coding unit for the chroma component into a first triangle-shaped partition and a second triangle-shaped partition based on enabling of a triangular prediction unit mode. Video decoder 300 may be configured to apply pixel blending using a set of weights for the YUV 4:2:0 format to generate a predicted block for the chroma component when the one or more processors generate the coding unit for chroma component in the YUV 4:2:0 format and when the one or more processors generate the coding unit for the

chroma component in the YUV 4:4:4 format. Hence, video decoder 300 may use a set of weights for both the YUV 4:2:0 format and the YUV 4:4:4 format, which may help to unify treatment of different chroma formats. Unifying treatment of different chroma formats may help to reduce codec processing overhead. To apply pixel blending, video decoder 300 may be configured to determine weighted averages, using the set of weights for the YUV 4:2:0 format, of collocated motion compensated pixels of the first triangle-shaped partition and the second triangle-shaped partition based on motion information of the first triangle-shaped partition and the second triangle-shaped partition, respectively.

[0133] In some examples, video decoder 300 represents an example of a device configured to encode video data including a memory configured to store video data, and one or more processors implemented in circuitry and configured to obtain unfiltered reference samples for an area of a picture. In this example, video decoder 300 may be configured to disable intra-reference sample smoothing of the unfiltered reference samples for chroma samples in a YUV 4:2:0 format and in a YUV 4:4:4 format. Video decoder 300 may be configured to generate, using intra-prediction, chroma samples of a prediction block for a block of the picture based on the unfiltered reference samples when generating the chroma components in the YUV 4:2:0 format and when generating the chroma components in the YUV 4:4:4 format. That is, for example, for chroma components in both the YUV 4:4:4 format and the YUV 4:4:4 format, video decoder 300 may use only unfiltered reference samples for chroma samples. In this way, a complexity of decoding video data may be reduced, which may reduce an amount of time video decoder 300 decodes video data and/or reduce a power consumption of video decoder 300. Techniques described herein for disabling intra-reference sample smoothing of the unfiltered reference samples for chroma samples may be used in combination with or separately from techniques described herein for generating a coding unit for chroma components in the YUV 4:2:0 format.

[0134] FIG. 5A is a conceptual diagram illustrating a first example of splitting a coding unit (CU) 429 into a first triangle-shaped partition 433 and a second triangle-shaped partition 435 based inter prediction, in accordance with the techniques of the disclosure. In the example of FIG. 5A, a video coder (e.g., video encoder 200 or video decoder 300) may split coding unit 429 into a first triangle-shaped partition 433 and a second triangle-shaped partition 435 when inter prediction is enabled and when triangular prediction unit mode is enabled. Examples of triangular prediction unit mode may be found in, for

example, J. Chen, Y. Ye, S. Kim, “Algorithm description for Versatile Video Coding and Test Model 4 (VTM 4)” Joint Video Exploration Team of ITU-T SG16 WP3 and ISO/IEC JTC1/SC29/WG11, JVET-M1002, Jan. 2019) and elsewhere. For example, based on enabling of a triangular prediction unit mode, the video coder may split a CU into two triangle-shaped partitions and each of the partitions has a reference index and uni-directional motion vector. The video coder may be configured to combine the two motion compensated partitions into a block of prediction samples and on the edge of the splitting edge, pixel blending is performed. In the example of FIG. 5A, first triangle-shaped partition 433 includes an upper-right corner sample of CU 429 and second triangle-shaped partition 435 includes a lower-left corner sample of CU 429.

[0135] Said differently, for example, a video coder (e.g., video encoder 200 or video decoder 300) may generate coding unit 429 for chroma components of a block of video data in a YUV 4:4:4 format or in a YUV 4:2:0 format. In this example, the video coder may split coding unit 429 for chroma components into first triangle-shaped partition 433 and second triangle-shaped partition 435 based on enabling of a triangular prediction unit mode.

[0136] FIG. 5B is a conceptual diagram illustrating a second example of splitting a coding unit 431 into a first triangle-shaped partition 434 and a second triangle-shaped partition 436 based on inter prediction, in accordance with the techniques of the disclosure.

[0137] For example, a video coder (e.g., video encoder 200 or video decoder 300) may generate coding unit 431 for chroma components of a block of video data in a YUV 4:4:4 format or in a YUV 4:2:0 format. In this example, the video coder may split coding unit 431 for chroma components into first triangle-shaped partition 434 and second triangle-shaped partition 436 based on enabling of a triangular prediction unit mode. In the example of FIG. 5B, first triangle-shaped partition 434 is arranged on an upper left of CU 429. In the example of FIG. 55, first triangle-shaped partition 434 includes an upper-left corner sample of CU 431 and second triangle-shaped partition 436 includes a lower-right corner sample of CU 431.

[0138] FIG. 6 is a conceptual diagram illustrating pixel blending with one set of weights, in accordance with the techniques of the disclosure. A video coder (e.g., video encoder 200 and/or video decoder 300) may be configured to perform the example pixel blending of FIG. 6 with one set of weights as shown in FIG. 6. The video coder may be configured to generate the pixels in blending areas by, for example, weighted averaging of the collocated motion compensated pixels based on motion information of the two

triangular partitions. As used herein, collocated pixels may refer to a first pixel of a first partition (e.g., a first triangle-shaped partition) that is positioned at a same pixel position as a second pixel of a second partition (e.g., a second triangle-shaped partition).

Weighted averaging is further explained in FIGS. 7A-7C.

[0139] That is, for example, a video coder (e.g., video encoder 200 or video decoder 300) may apply pixel blending using a set of weights to generate a predicted block for the chroma components of the block of video data. In this example, to apply pixel blending, the video coder may determine weighted averages, using the set of weights, of collocated motion compensated pixels of first triangle-shaped partition (shown as “P₁”) and the second triangle-shaped partition (shown as “P₂”) based on motion information of the first triangle-shaped partition and the second triangle-shaped partition.

[0140] For example, as shown in FIG. 6, a video coder (e.g., video encoder 200 or video decoder 300) may determine a pixel value P for pixels marked with “2” of predicted block 537 for luma components and/or predicted block 538 for luma components by calculating the respective value P for each pixel according to EQUATION 1.

$$P = \frac{2}{8} * P_1 + \frac{6}{8} * P_2 \quad \text{EQUATION 1}$$

where P₁ is a first reference pixel value of a first collocated motion compensated pixel of the first triangle-shaped partition collocated with the respective pixel marked with “2” in this example and where P₂ is a second reference pixel value of a second collocated motion compensated pixel of the first triangle-shaped partition collocated with the respective pixel marked with “2” in this example.

[0141] As further shown in FIG. 6, a video coder (e.g., video encoder 200 or video decoder 300) may determine a pixel value P for pixels marked with “4” of predicted block 537 for luma components and/or predicted block 538 for luma components by calculating the respective value P for each pixel according to EQUATION 2.

$$P = \frac{4}{8} * P_1 + \frac{4}{8} * P_2 \quad \text{EQUATION 2}$$

where P₁ is a first reference pixel value of a first collocated motion compensated pixel of the first triangle-shaped partition collocated with the respective pixel marked with “4” in this example and where P₂ is a second reference pixel value of a second collocated motion compensated pixel of the first triangle-shaped partition collocated with the respective pixel marked with “4” in this example.

[0142] As further shown in FIG. 6, a video coder (e.g., video encoder 200 or video decoder 300) may determine a pixel value P for pixels marked with “7” of predicted block 537 for luma components and/or predicted block 538 for luma components by calculating the respective value P for each pixel according to EQUATION 3.

$$P = \frac{7}{8} * P_1 + \frac{1}{8} * P_2 \quad \text{EQUATION 3}$$

where P₁ is a first reference pixel value of a first collocated motion compensated pixel of the first triangle-shaped partition collocated with the respective pixel marked with “7” in this example and where P₂ is a second reference pixel value of a second collocated motion compensated pixel of the first triangle-shaped partition collocated with the respective pixel marked with “7” in this example.

[0143] The values “1” and “6” represent equations corresponding to EQUATIONS 1–3. That is, a video coder (e.g., video encoder 200 or video decoder 300) may determine a pixel value P for pixels marked with “1” of predicted block 537 for luma components and/or predicted block 538 for luma components by calculating the respective value P for each pixel according to EQUATION 4.

$$P = \frac{1}{8} * P_1 + \frac{7}{8} * P_2 \quad \text{EQUATION 4}$$

where P₁ is a first reference pixel value of a first collocated motion compensated pixel of the first triangle-shaped partition and where P₂ is a second reference pixel value of a second collocated motion compensated pixel of the first triangle-shaped partition.

[0144] A video coder (e.g., video encoder 200 or video decoder 300) may determine a pixel value P for pixels marked with “6” of predicted block 537 for luma components and/or predicted block 538 for luma components by calculating the respective value P for each pixel according to EQUATION 5.

$$P = \frac{6}{8} * P_1 + \frac{2}{8} * P_2 \quad \text{EQUATION 5}$$

where P₁ is a first reference pixel value of a first collocated motion compensated pixel of the first triangle-shaped partition and where P₂ is a second reference pixel value of a second collocated motion compensated pixel of the first triangle-shaped partition.

[0145] While the example illustrated in FIG. 6 shows an example set of weights {7/8, 6/8, 4/8, 2/8, 1/8} for luma and {7/8, 4/8, 1/8} for chroma, other examples may use different weights. For example, there may be two sets of weights and in each set chroma weights and luma weights may be defined separately:

- 1st set: {7/8, 6/8, 4/8, 2/8, 1/8} for luma and {7/8, 4/8, 1/8} for chroma.
- 2nd set: {7/8, 6/8, 5/8, 4/8, 3/8, 2/8, 1/8} for luma and {6/8, 4/8, 2/8} for chroma.

[0146] The 2nd set of weight values (e.g., {6/8, 4/8, 2/8}) is explained with reference to FIGS. 7A–7C for example purposes only.

[0147] FIG. 7A is a conceptual diagram illustrating further details of a first triangle-shaped partition 639 for the pixel blending of FIG. 6, in accordance with the techniques of the disclosure. As shown, first triangle-shaped partition 639 includes collocated motion compensated pixels A, B and C of first triangle-shaped partition 639. For instance, a video coder (e.g., video encoder 200 or video decoder 300) may generate the collocated motion compensated pixels A, B and C of first triangle-shaped partition 639 using motion information (e.g., a uni-directional motion vector) for first triangle-shaped partition 639. In this example, the video coder may not apply weighted averaging to pixels in first pixel group 642.

[0148] FIG. 7B is a conceptual diagram illustrating further details of a second triangle-shaped partition 640 for the pixel blending of FIG. 6, in accordance with the techniques of the disclosure. As shown, second triangle-shaped partition 640 includes collocated motion compensated pixels A, B and C of second triangle-shaped partition 640. For instance, a video coder (e.g., video encoder 200 or video decoder 300) may generate the collocated motion compensated pixels A, B and C of second triangle-shaped partition 640 using motion information (e.g., a uni-directional motion vector) for second triangle-shaped partition 640. In this example, the video coder may not apply weighted averaging to pixels in second pixel group 643.

[0149] FIG. 7C is a conceptual diagram illustrating further details of a block 641 formed using the pixel blending of FIG. 6, in accordance with the techniques of the disclosure. In this example, a video coder (e.g., video encoder 200 or video decoder 300) may determine a weighted average of collocated motion compensated pixels of first triangle-shaped partition 639 and second triangle-shaped partition 640 based on motion information of first triangle-shaped partition 639 and second triangle-shaped partition 640.

[0150] In the example of FIG. 7C, a video coder (e.g., video encoder 200 or video decoder 300) may use the 2nd set of weight values (e.g., {6/8, 4/8, 2/8} for chroma). For example, the video coder may determine a pixel value P of pixel ‘A’ of predicted block 641 by calculating the pixel value P according to EQUATION 6.

$$P = \frac{4}{8} * P_1 + \frac{4}{8} * P_2, \quad \text{EQUATION 6}$$

where P_1 is a first reference pixel value of a first collocated motion compensated pixel of first triangle-shaped partition 639 (e.g., 'A' of first triangle-shaped partition 639 FIG. 7A) and wherein P_2 is a second reference pixel value of a second collocated motion compensated pixel of second triangle-shaped partition 640 (e.g., 'A' of second triangle-shaped partition 640 of FIG. 7B).

[0151] A video coder (e.g., video encoder 200 or video decoder 300) may determine a pixel value P of pixel 'B' of predicted block 641 by calculating the pixel value P according to EQUATION 7.

$$P = \frac{2}{8} * P_1 + \frac{6}{8} * P_2 \quad \text{EQUATION 7}$$

where P_1 is a first reference pixel value of a first collocated motion compensated pixel of first triangle-shaped partition 639 (e.g., 'B' of first triangle-shaped partition 639 FIG. 7A) and wherein P_2 is a second reference pixel value of a second collocated motion compensated pixel of second triangle-shaped partition 640 (e.g., 'B' of second triangle-shaped partition 640 of FIG. 7B).

[0152] A video coder (e.g., video encoder 200 or video decoder 300) may determine a pixel value P of pixel 'C' of predicted block 641 by calculating the pixel value P according to EQUATION 8.

$$P = \frac{6}{8} * P_1 + \frac{2}{8} * P_2 \quad \text{EQUATION 8}$$

where P_1 is a first reference pixel value of a first collocated motion compensated pixel of first triangle-shaped partition 639 (e.g., 'C' of first triangle-shaped partition 639 FIG. 7A) and wherein P_2 is a second reference pixel value of a second collocated motion compensated pixel of second triangle-shaped partition 640 (e.g., 'C' of second triangle-shaped partition 640 of FIG. 7B).

[0153] In some examples, a video coder (e.g., video encoder 200 or video decoder 300) may use the 1st set of weight values (e.g., $\{7/8, 4/8, 1/8\}$ for chroma). For example, the video coder may determine a pixel value P of pixel 'A' of predicted block 641 by calculating the pixel value P according to EQUATION 9.

$$P = \frac{4}{8} * P_1 + \frac{4}{8} * P_2, \quad \text{EQUATION 9}$$

where P_1 is a first reference pixel value of a first collocated motion compensated pixel of first triangle-shaped partition 639 (e.g., 'A' of first triangle-shaped partition 639 FIG. 7A) and wherein P_2 is a second reference pixel value of a second collocated motion compensated pixel of second triangle-shaped partition 640 (e.g., 'A' of second triangle-shaped partition 640 of FIG. 7B).

[0154] A video coder (e.g., video encoder 200 or video decoder 300) may determine a pixel value P of pixel 'B' of predicted block 641 by calculating the pixel value P according to EQUATION 10.

$$P = \frac{1}{8} * P_1 + \frac{7}{8} * P_2 \quad \text{EQUATION 10}$$

where P₁ is a first reference pixel value of a first collocated motion compensated pixel of first triangle-shaped partition 639 (e.g., 'B' of first triangle-shaped partition 639 FIG. 7A) and wherein P₂ is a second reference pixel value of a second collocated motion compensated pixel of second triangle-shaped partition 640 (e.g., 'B' of second triangle-shaped partition 640 of FIG. 7B).

[0155] A video coder (e.g., video encoder 200 or video decoder 300) may determine a pixel value P of pixel 'C' of predicted block 641 by calculating the pixel value P according to EQUATION 11.

$$P = \frac{7}{8} * P_1 + \frac{1}{8} * P_2 \quad \text{EQUATION 11}$$

where P₁ is a first reference pixel value of a first collocated motion compensated pixel of first triangle-shaped partition 639 (e.g., 'C' of first triangle-shaped partition 639 FIG. 7A) and wherein P₂ is a second reference pixel value of a second collocated motion compensated pixel of second triangle-shaped partition 640 (e.g., 'C' of second triangle-shaped partition 640 of FIG. 7B).

[0156] In some video coders, the weights of luma and chroma may be unified when using the YUV 4:4:4 format. As such, if a video encoder (e.g., video encoder 200) encodes the video signal in YUV 4:4:4 format, the video coder (e.g., video encoder 200 or video decoder 300) may be configured to not use the chroma part of each set of weights and apply the luma part of each set of weights to both luma and chroma edges.

[0157] In video codecs, the samples used for intra prediction may be obtained from a reconstructed area of the same picture and the samples obtained may be smoothed by applying some filter to it to improve the quality of prediction signal. For example, an example description of intra reference sample smoothing of HEVC can be found in J. Lainema, F. Bossen, W. Han, J. Min and K. Ugur, "Intra Coding of the HEVC Standard," in IEEE Transactions on Circuits and Systems for Video Technology, vol. 22, no. 12, pp. 1792-1801, Dec. 2012. In some examples, video encoder 200 or video decoder 300 may be configured to use other intra reference sample smoothing examples.

[0158] In some VVC designs, when the chroma format is YUV 4:2:0, chroma components will always use unfiltered reference samples. In the case of YUV 4:4:4,

however, the chroma component is subject to the same rule as luma to determine whether filtered reference samples should be used. Said differently, in some VVC designs, when chroma components are to be generated in a YUV 4:2:0 format, video encoder 200 or video decoder 300 may be configured to always use unfiltered reference samples to generate chroma components. In this example, when chroma components are to be generated in a YUV 4:4:4 format, video encoder 200 or video decoder 300 may be configured to determine whether to use unfiltered reference samples or filtered reference samples to generate chroma components.

[0159] For example, in response to determining to enable intra-reference sample smoothing for generating luma samples, a video coder (e.g., video encoder 200 or video decoder 300) may be configured to perform one or more filter operations on unfiltered reference samples to generate filtered reference samples. In this example, the video coder may be configured to generate, using intra-prediction, luma samples for the block of the picture based on the filtered reference samples. In some examples, performing the one or more filter operations on the unfiltered reference samples may include performing one or more deblocking operations on the unfiltered reference samples.

[0160] As such, some VVC designs may treat different chroma formats differently in the triangular PU mode and extra complexity is introduced to codec design. At the same time, the operations defined for the luma component may be more complex than those defined for chroma components (e.g. as shown in FIG. 6, the blending area for luma has the width of three samples while for chroma the blending area is two samples).

[0161] In accordance with the techniques of the disclosure, a video coder (e.g., video encoder 200 or video decoder 300) may be configured to unify the treatment of chroma components for different chroma formats. For example, for triangular PU mode, the video coder (encoder 200 or decoder 300) may be configured to use weights for YUV 4:2:0 chroma components instead of those for the luma component for chroma components of YUV 4:4:4 format. In the example of the current VVC draft, the two sets of weights that are designed for chroma components of YUV 4:2:0 format are as follows:

- 1) {1,4,7}
- 2) {2,4,6}

[0162] In this example, a video coder (e.g., video encoder 200 or video decoder 300) may be configured to handle YUV 4:4:4 chroma components and YUV 4:2:0 chroma

components to be the same. The video coder may be configured to apply combinations of these two sets of weights to YUV4:4:4 chroma components. For example, the video coder may be configured to apply a set of weights {1, 4, 7}, a set of weights of {2, 4, 6}, or a set of weights of {1, 4, 7} and {2, 4, 6}.

[0163] Said differently, for example, a video coder (e.g., video encoder 200 or video decoder 300) may apply pixel blending using a set of weights for the YUV 4:2:0 format to generate a predicted block for the chroma components of the block of video data when the video coder generates the coding unit for chroma components in the YUV 4:2:0 format and when the video coder generates the coding unit for chroma components in the YUV 4:4:4 format. In this example, the video coder may be configured to apply a set of weights {1, 4, 7}, a set of weights of {2, 4, 6}, or a set of weights of {1, 4, 7} and {2, 4, 6}.

[0164] In some examples, applying pixel blending includes determining weighted averages as discussed in detail in FIGS. 6 and 7A-7C. For example, a video coder (e.g., video encoder 200 or video decoder 300) may be configured to determine weighted averages, using the set of weights for the YUV 4:2:0 format, of collocated motion compensated pixels of a first triangle-shaped partition and a second triangle-shaped partition based on motion information of the first triangle-shaped partition and the second triangle-shaped partition.

[0165] An example of a weighted sample prediction process for triangle merge mode is as follows.

Inputs to this process are:

- two variables nCbW and nCbH specifying the width and the height of the current coding block,
- two (nCbW)x(nCbH) arrays predSamplesLA and predSamplesLB,
- a variable triangleDir specifying the partition direction,
- a variable cIdx specifying colour component index.

Output of this process is the (nCbW)x(nCbH) array pbSamples of prediction sample values.

The variable nCbR is derived as follows:

$$nCbR = (nCbW > nCbH) ? (nCbW / nCbH) : (nCbH / nCbW) \quad (8-841)$$

The variable bitDepth is derived as follows:

- If cIdx is equal to 0, bitDepth is set equal to BitDepth_Y.
 - Otherwise, bitDepth is set equal to BitDepth_C.

Variables shift1 and offset1 are derived as follows:

- The variable shift1 is set equal to Max(5, 17 – bitDepth).
- The variable offset1 is set equal to 1 << (shift1 – 1).

Depending on the values of triangleDir, wS and cIdx, the prediction samples pbSamples[x][y] with x = 0..nC_bW – 1 and y = 0..nC_bH – 1 are derived as follows:

- The variable wIdx is derived as follows:

- If cIdx is equal to 0 and triangleDir is equal to 0, the following applies:

$$\begin{aligned} wIdx = (nCbW > nCbH) ? (Clip3(0, 8, (x / nCbR - y) + 4)) & \quad (8-842) \\ & : (Clip3(0, 8, (x - y / nCbR) + 4)) \end{aligned}$$

- Otherwise, if cIdx is equal to 0 and triangleDir is equal to 1, the following applies:

$$\begin{aligned} wIdx = (nCbW > nCbH) ? (Clip3(0, 8, (nCbH - 1 - x / nCbR - y) + 4)) & \\ (8-843) & \\ & (Clip3(0, 8, (nCbW - 1 - x - y / nCbR) + 4)) \end{aligned}$$

- Otherwise, if cIdx is greater than 0 and triangleDir is equal to 0, the following applies:

$$\begin{aligned} wIdx = (nCbW > nCbH) ? (Clip3(0, 4, (x / nCbR - y) + 2)) & \quad (8-844) \\ & : (Clip3(0, 4, (x - y / nCbR) + 2)) \end{aligned}$$

- Otherwise (if cIdx is greater than 0 and triangleDir is equal to 1), the following applies:

$$\begin{aligned} wIdx = (nCbW > nCbH) ? (Clip3(0, 4, (nCbH - 1 - x / nCbR - y) + 2)) & \\ (8-845) & \\ & (Clip3(0, 4, (nCbW - 1 - x - y / nCbR) + 2)) \end{aligned}$$

- The variable wValue specifying the weight of the prediction sample is derived using wIdx and cIdx as follows:

$$wValue = (cIdx == 0) ? Clip3(0, 8, wIdx) : Clip3(0, 8, wIdx * 2) \quad (8-846)$$

- The prediction sample values are derived as follows:

$$\text{pbSamples}[x][y] = \text{Clip3}(0, (1 \ll \text{bitDepth}) - 1, \\ (\text{predSamplesLA}[x][y] * \text{wValue} + (8-847)$$

$$\text{predSamplesLB}[x][y] * (8 - \text{wValue}) + \text{offset1}) \gg \text{shift1})$$

[0166] In the above example, $\text{cIdx} > 0$ means chroma. Additionally, $\text{wValue} = \text{clip3}(0, 8, \text{wIdx} * 2)$ is for chroma components. As such, when $\text{wIdx} = 0, 1, 2, 3, 4$ respectively, the $\text{wValue} = 8, 6, 4, 2, 0$. Moreover, $\text{blended_pixel} = (\text{wValue} * \text{predLA} + (8 - \text{wValue}) * \text{predLB}) \gg \text{shift}$. As such, the blending weights used for chroma is 0, 2, 4, 6, 8 (e.g., {2, 4, 6}). In this example, weight 0 or 8 may refer to copying one candidate pixel instead of blending two pixels.

[0167] In some examples, for intra prediction, a video coder (e.g., video encoder 200 or video decoder 300) may be configured to align the behavior of intra reference sample smoothing on chroma components of YUV 4:4:4 format to that on chroma components of YUV 4:2:0 format. In the current VVC draft, the intra reference sample smoothing is disabled for YUV 4:2:0 chroma components. According to some examples, video encoder 200 and/or video decoder 300 may be configured to disable the intra reference sample smoothing for YUV 4:4:4 chroma components.

[0168] Said differently, for example, a video coder (e.g., video encoder 200 or video decoder 300) may be configured to obtain unfiltered reference samples for an area of a picture. In this example, the video coder may be configured to disable intra-reference sample smoothing of the unfiltered reference samples for chroma samples in a YUV 4:2:0 format and chroma samples in a YUV 4:4:4 format. In this example, the video coder may be configured to generate, using intra-prediction, chroma samples of a prediction block for a block of the picture based on the unfiltered reference samples both when generating the chroma components in the YUV 4:2:0 format and when generating the chroma components in the YUV 4:4:4 format.

[0169] FIG. 8 is a flowchart illustrating an example method for encoding a current block. The current block may comprise a current CU. Although described with respect to video encoder 200 (FIGS. 1 and 3), it should be understood that other devices may be configured to perform a method similar to that of FIG. 8.

[0170] In this example, video encoder 200 initially predicts the current block (750). In some examples “current block” may be referred to herein as simply “block.” For example, video encoder 200 may form a prediction block for the current block using unified weight information for different chroma formats. In some examples, video encoder 200 may generate, using intra-prediction, chroma samples of a prediction block for a block of the picture based on the unfiltered reference samples when generating the chroma components in the YUV 4:2:0 format and when generating the chroma components in the YUV 4:4:4 format.

[0171] Video encoder 200 may then calculate a residual block for the current block (752). To calculate the residual block, video encoder 200 may calculate a difference between the original, uncoded block and the prediction block for the current block, generating a residual block. Video encoder 200 may then transform residual values of the residual block and quantize transform coefficients (754). Next, video encoder 200 may scan the quantized transform coefficients of the residual block (756). During the scan, or following the scan, video encoder 200 may entropy encode the coefficients (758). For example, video encoder 200 may encode the coefficients using CAVLC or CABAC. Video encoder 200 may then output the entropy coded data of the block (760).

[0172] FIG. 9 is a flowchart illustrating an example method for decoding a current block of video data, in accordance with the techniques of the disclosure. The current block may comprise a current CU. Although described with respect to video decoder 300 (FIGS. 1 and 4), it should be understood that other devices may be configured to perform a method similar to that of FIG. 9.

[0173] Video decoder 300 may receive entropy coded data for the current block, such as entropy coded prediction information and entropy coded data for coefficients of a residual block corresponding to the current block (870). Video decoder 300 may entropy decode the entropy coded data to determine prediction information for the current block and to reproduce coefficients of the residual block (872).

[0174] Video decoder 300 may predict the current block (874). For example, video decoder 300 may predict the current block using unified weight information for different chroma formats, e.g., using an intra- or inter-prediction mode as indicated by the prediction information for the current block, to calculate a prediction block for the current block. In some examples, video decoder 300 may generate, using intra-prediction, chroma samples of a prediction block for a block of the picture based on the

unfiltered reference samples when generating the chroma components in the YUV 4:2:0 format and when generating the chroma components in the YUV 4:4:4 format.

[0175] Video decoder 300 may then inverse scan the reproduced coefficients (876), to create a block of quantized transform coefficients. Video decoder 300 may then inverse quantize and inverse transform the coefficients to produce a residual block (878). Video decoder 300 may ultimately decode the current block by combining the prediction block and the residual block (880).

[0176] FIG. 10 is a flowchart illustrating an example process for pixel blending of chroma components for a block of video data with a set of weights for a YUV 4:2:0, in accordance with the techniques of the disclosure. Although described with respect to video encoder 200 (FIGS. 1 and 3) and video decoder 300 (FIGS. 1 and 4), it should be understood that other devices may be configured to perform a method similar to that of FIG. 10.

[0177] In accordance with the techniques of the disclosure, a video coder (e.g., video encoder 200 or video decoder 300) may generate a coding unit for a chroma component of a block of video data in a YUV 4:4:4 format or in a YUV 4:2:0 format (982). The video coder may split the coding unit for the chroma component into a first triangle-shaped partition and a second triangle-shaped partition based on enabling of a triangular prediction unit mode (984).

[0178] The video coder may apply pixel blending using a set of weights for the YUV 4:2:0 format to generate a predicted block for the chroma component when the one or more processors generate the coding unit for chroma components in the YUV 4:2:0 format and when the one or more processors generate the coding unit for chroma components in the YUV 4:4:4 format (986). In some examples, to apply pixel blending, the video coder may determine a weighted average, using the set of weights for the YUV 4:2:0 format, of collocated motion compensated pixels of the first triangle-shaped partition and the second triangle-shaped partition based on motion information of the first triangle-shaped partition and the second triangle-shaped partition.

[0179] In examples where the video coder comprises a video decoder (e.g., video decoder 300), the video decoder may decode a residual block for the block of video data and combine the predicted block for the chroma components and the residual block to decode the block of video data. In examples where the video coder comprises a video encoder, the video encoder may generate a residual block for the block of video data based on differences between the block of video data and the predicted block and encode the residual block.

[0180] FIG. 11 is a flowchart illustrating an example process for generating chroma samples of a prediction block using intra-prediction. Although described with respect to video encoder 300 (FIGS. 1 and 3) and video decoder 300 (FIGS. 1 and 4), it should be understood that other devices may be configured to perform a method similar to that of FIG. 11.

[0181] In accordance with the techniques of the disclosure, a video coder (e.g., video encoder 200 or video decoder 300) may obtain unfiltered reference samples for an area of a picture (1090). In some examples, the video coder may disable intra-reference sample smoothing of the unfiltered reference samples for chroma samples in a YUV 4:2:0 format and in a YUV 4:4:4 format. The video coder may generate, using intra-prediction, chroma samples of a prediction block for a block of the picture based on the unfiltered reference samples when generating the chroma components in the YUV 4:2:0 format and when generating the chroma components in the YUV 4:4:4 format (1092).

[0182] In examples where the video coder comprises a video decoder (e.g., video decoder 300), the video decoder may decode a residual block for the block of video data and combine the predicted block for the chroma components and the residual block to decode the block of video data. In examples where the video coder comprises a video encoder, the video encoder may generate a residual block for the block of video data based on differences between the block of video data and the predicted block and encode the residual block.

[0183] Illustrative examples of the disclosure include:

[0184] Example 1: A method of processing video data, the method comprising: determining weight information for a first chroma format; determining weight information for a second chroma format different from the first chroma format to correspond to the weight information for the first chroma format; and generating prediction information based on the weight information for the first chroma format.

[0185] Example 2. The method of example 1, comprising: determining a mode is a triangular prediction unit (PU) mode, wherein determining weight information for a second chroma format is in response to determining the mode is the triangular PU mode.

[0186] Example 3. The method of any combination of examples 1–2, wherein the first chroma format is YUV 4:2:0, wherein the second chroma format is YUV 4:4:4.

[0187] Example 4. The method of example 3, wherein the weight information for the first chroma format is: 1) {1, 4, 7}2) {2, 4, 6}.

[0188] Example 5. The method of example 1, comprising: in response to determining intra-prediction is applied, aligning the behavior of intra reference sample smoothing on chroma components of YUV 4:4:4 format that on YUV 4:2:0 format.

[0189] Example 6. The method of example 5, wherein aligning comprises: disabling the intra reference sample smoothing for YUV4:2:0 chroma components; and disabling the intra reference sample smoothing for YUV4:4:4 chroma components.

[0190] Example 7. The method of any of examples 1–6, wherein processing comprises decoding.

[0191] Example 8. The method of any of examples 1–6, wherein processing comprises encoding.

[0192] Example 9. A device for coding video data, the device comprising one or more means for performing the method of any of examples 1–6.

[0193] Example 10. The device of example 9, wherein the one or more means comprise one or more processors implemented in circuitry.

[0194] Example 11. The device of any of examples 9 and 10, further comprising a memory to store the video data.

[0195] Example 12. The device of any of examples 9–11, further comprising a display configured to display decoded video data.

[0196] Example 13. The device of any of examples 9–12, wherein the device comprises one or more of a camera, a computer, a mobile device, a broadcast receiver device, or a set-top box.

[0197] Example 14. The device of any of examples 9–13, wherein the device comprises a video decoder.

[0198] Example 15. The device of any of examples 9–14, wherein the device comprises a video encoder.

[0199] Example 16. A computer-readable storage medium having stored thereon instructions that, when executed, cause one or more processors to perform the method of any of examples 1–6.

[0200] It is to be recognized that depending on the example, certain acts or events of any of the techniques described herein can be performed in a different sequence, may be added, merged, or left out altogether (e.g., not all described acts or events are necessary for the practice of the techniques). Moreover, in certain examples, acts or events may be performed concurrently, e.g., through multi-threaded processing, interrupt processing, or multiple processors, rather than sequentially.

[0201] In one or more examples, the functions described may be implemented in hardware, software, firmware, or any combination thereof. If implemented in software, the functions may be stored on or transmitted over as one or more instructions or code on a computer-readable medium and executed by a hardware-based processing unit. Computer-readable media may include computer-readable storage media, which corresponds to a tangible medium such as data storage media, or communication media including any medium that facilitates transfer of a computer program from one place to another, e.g., according to a communication protocol. In this manner, computer-readable media generally may correspond to (1) tangible computer-readable storage media which is non-transitory or (2) a communication medium such as a signal or carrier wave. Data storage media may be any available media that can be accessed by one or more computers or one or more processors to retrieve instructions, code and/or data structures for implementation of the techniques described in this disclosure. A computer program product may include a computer-readable medium.

[0202] By way of example, and not limitation, such computer-readable storage media can comprise RAM, ROM, EEPROM, CD-ROM or other optical disk storage, magnetic disk storage, or other magnetic storage devices, flash memory, or any other medium that can be used to store desired program code in the form of instructions or data structures and that can be accessed by a computer. Also, any connection is properly termed a computer-readable medium. For example, if instructions are transmitted from a website, server, or other remote source using a coaxial cable, fiber optic cable, twisted pair, digital subscriber line (DSL), or wireless technologies such as infrared, radio, and microwave, then the coaxial cable, fiber optic cable, twisted pair, DSL, or wireless technologies such as infrared, radio, and microwave are included in the definition of medium. It should be understood, however, that computer-readable storage media and

data storage media do not include connections, carrier waves, signals, or other transitory media, but are instead directed to non-transitory, tangible storage media. Disk and disc, as used herein, includes compact disc (CD), laser disc, optical disc, digital versatile disc (DVD), floppy disk and Blu-ray disc, where disks usually reproduce data magnetically, while discs reproduce data optically with lasers. Combinations of the above should also be included within the scope of computer-readable media.

[0203] Instructions may be executed by one or more processors, such as one or more digital signal processors (DSPs), general purpose microprocessors, application specific integrated circuits (ASICs), field programmable gate arrays (FPGAs), or other equivalent integrated or discrete logic circuitry. Accordingly, the terms “processor” and “processing circuitry,” as used herein may refer to any of the foregoing structures or any other structure suitable for implementation of the techniques described herein. In addition, in some aspects, the functionality described herein may be provided within dedicated hardware and/or software modules configured for encoding and decoding, or incorporated in a combined codec. Also, the techniques could be fully implemented in one or more circuits or logic elements.

[0204] The techniques of this disclosure may be implemented in a wide variety of devices or apparatuses, including a wireless handset, an integrated circuit (IC) or a set of ICs (e.g., a chip set). Various components, modules, or units are described in this disclosure to emphasize functional aspects of devices configured to perform the disclosed techniques, but do not necessarily require realization by different hardware units. Rather, as described above, various units may be combined in a codec hardware unit or provided by a collection of interoperative hardware units, including one or more processors as described above, in conjunction with suitable software and/or firmware.

[0205] Various examples have been described. These and other examples are within the scope of the following claims.

WHAT IS CLAIMED IS:

1. A method of processing video data, the method comprising:
 - generating, by one or more processors implemented in circuitry, a coding unit for a chroma component of a block of video data in a YUV 4:4:4 format or in a YUV 4:2:0 format;
 - splitting, by the one or more processors, the coding unit for the chroma component into a first triangle-shaped partition and a second triangle-shaped partition based on enabling of a triangular prediction unit mode; and
 - applying, by the one or more processors, pixel blending using a set of weights for the YUV 4:2:0 format to generate a predicted block for the chroma component when the one or more processors generate the coding unit for the chroma component in the YUV 4:2:0 format and when the one or more processors generate the coding unit for the chroma component in the YUV 4:4:4 format, wherein applying pixel blending comprises determining weighted averages, using the set of weights for the YUV 4:2:0 format, of collocated motion compensated pixels of the first triangle-shaped partition and the second triangle-shaped partition based on motion information of the first triangle-shaped partition and the second triangle-shaped partition, respectively.

2. The method of claim 1, wherein determining weighted averages comprises determining a pixel value P of the predicted block by calculating:

$$P = \frac{2}{8} * P_1 + \frac{6}{8} * P_2,$$

wherein P_1 is a first reference pixel value of a first collocated motion compensated pixel of the first triangle-shaped partition and wherein P_2 is a second reference pixel value of a second collocated motion compensated pixel of the second triangle-shaped partition.

3. The method of claim 1, wherein determining weighted averages comprises determining a pixel value P of the predicted block by calculating:

$$P = \frac{4}{8} * P_1 + \frac{4}{8} * P_2,$$

wherein P_1 is a first reference pixel value of a first collocated motion compensated pixel of the first triangle-shaped partition and wherein P_2 is a second reference pixel value of a second collocated motion compensated pixel of the second triangle-shaped partition.

4. The method of claim 1, wherein determining weighted averages comprises determining a pixel value P of the predicted block by calculating:

$$P = \frac{6}{8} * P_1 + \frac{2}{8} * P_2,$$

wherein P_1 is a first reference pixel value of a first collocated motion compensated pixel of the first triangle-shaped partition and wherein P_2 is a second reference pixel value of a second collocated motion compensated pixel of the second triangle-shaped partition.

5. The method of claim 1, wherein determining weighted averages comprises determining a pixel value P of the predicted block by calculating:

$$P = \frac{1}{8} * P_1 + \frac{7}{8} * P_2,$$

wherein P_1 is a first reference pixel value of a first collocated motion compensated pixel of the first triangle-shaped partition and wherein P_2 is a second reference pixel value of a second collocated motion compensated pixel of the second triangle-shaped partition.

6. The method of claim 1, wherein determining weighted averages comprises determining a pixel value P of the predicted block by calculating:

$$P = \frac{7}{8} * P_1 + \frac{1}{8} * P_2,$$

wherein P_1 is a first reference pixel value of a first collocated motion compensated pixel of the first triangle-shaped partition and wherein P_2 is a second reference pixel value of a second collocated motion compensated pixel of the second triangle-shaped partition.

7. The method of claim 1, comprising:
 - decoding, by the one or more processors, a residual block for the block of video data; and
 - combining, by the one or more processors, the predicted block and the residual block to decode the block of video data.

8. The method of claim 1, comprising:
 - generating, by the one or more processors, a residual block for the block of video data based on differences between the block of video data and the predicted block; and
 - encoding, by the one or more processors, the residual block.

9. A device for processing video data, the device comprising:
 - a memory configured to store video data; and
 - one or more processors implemented in circuitry and configured to:
 - generate a coding unit for a chroma component of a block of video data in a YUV 4:4:4 format or in a YUV 4:2:0 format;
 - split the coding unit for the chroma component into a first triangle-shaped partition and a second triangle-shaped partition based on enabling of a triangular prediction unit mode; and
 - apply pixel blending using a set of weights for the YUV 4:2:0 format to generate a predicted block for the chroma component when the one or more processors generate the coding unit for the chroma component in the YUV 4:2:0 format and when the one or more processors generate the coding unit for the chroma component in the YUV 4:4:4 format, wherein, to apply pixel blending, the one or more processors are configured to determine weighted averages, using the set of weights for the YUV 4:2:0 format, of collocated motion compensated pixels of the first triangle-shaped partition and the second triangle-shaped partition based on motion information of the first triangle-shaped partition and the second triangle-shaped partition, respectively.

10. The device of claim 9, wherein, to determine weighted averages, the one or more processors are configured to determine a pixel value P of the predicted block by calculating:

$$P = \frac{2}{8} * P_1 + \frac{6}{8} * P_2,$$

wherein P_1 is a first reference pixel value of a first collocated motion compensated pixel of the first triangle-shaped partition and wherein P_2 is a second reference pixel value of a second collocated motion compensated pixel of the second triangle-shaped partition.

11. The device of claim 9, wherein, to determine weighted averages, the one or more processors are configured to determine a pixel value P of the predicted block by calculating:

$$P = \frac{4}{8} * P_1 + \frac{4}{8} * P_2,$$

wherein P_1 is a first reference pixel value of a first collocated motion compensated pixel of the first triangle-shaped partition and wherein P_2 is a second reference pixel value of a second collocated motion compensated pixel of the second triangle-shaped partition.

12. The device of claim 9, wherein, to determine weighted averages, the one or more processors are configured to determine a pixel value P of the predicted block by calculating:

$$P = \frac{6}{8} * P_1 + \frac{2}{8} * P_2,$$

wherein P_1 is a first reference pixel value of a first collocated motion compensated pixel of the first triangle-shaped partition and wherein P_2 is a second reference pixel value of a second collocated motion compensated pixel of the second triangle-shaped partition.

13. The device of claim 9, wherein, to determine weighted averages, the one or more processors are configured to determine a pixel value P of the predicted block by calculating:

$$P = \frac{1}{8} * P_1 + \frac{7}{8} * P_2,$$

wherein P_1 is a first reference pixel value of a first collocated motion compensated pixel of the first triangle-shaped partition and wherein P_2 is a second reference pixel value of a second collocated motion compensated pixel of the second triangle-shaped partition.

14. The device of claim 9, wherein, to determine weighted averages, the one or more processors are configured to determine a pixel value P of the predicted block by calculating:

$$P = \frac{7}{8} * P_1 + \frac{1}{8} * P_2,$$

wherein P_1 is a first reference pixel value of a first collocated motion compensated pixel of the first triangle-shaped partition and wherein P_2 is a second reference pixel value of a second collocated motion compensated pixel of the second triangle-shaped partition.

15. The device of claim 9, wherein the one or more processors are further configured to:

decode a residual block for the block of video data; and

combine the predicted block and the residual block to decode the block of video data.

16. The device of claim 9, wherein the one or more processors are further configured to:

generate a residual block for the block of video data based on differences between the block of video data and the predicted block; and
encode the residual block.

17. The device of claim 9, wherein the device comprises one or more of a camera, a computer, a mobile device, a broadcast receiver device, or a set-top box.

18. A computer-readable storage medium having stored thereon instructions that, when executed, cause one or more processors to:

generate a coding unit for a chroma component of a block of video data in a YUV 4:4:4 format or in a YUV 4:2:0 format;

split the coding unit for the chroma component into a first triangle-shaped partition and a second triangle-shaped partition based on enabling of a triangular prediction unit mode; and

apply pixel blending using a set of weights for the YUV 4:2:0 format to generate a predicted block for the chroma component when the one or more processors generate the coding unit for the chroma component in the YUV 4:2:0 format and when the one or more processors generate the coding unit for the chroma component in the YUV 4:4:4 format, wherein the instructions that cause the one or more processors to apply pixel blending cause the one or more processors to determine weighted averages, using the set of weights for the YUV 4:2:0 format, of collocated motion compensated pixels of the first triangle-shaped partition and the second triangle-shaped partition based on motion information of the first triangle-shaped partition and the second triangle-shaped partition, respectively.

19. A device for coding video data, the device comprising:

means for generating a coding unit for a chroma component of a block of video data in a YUV 4:4:4 format or in a YUV 4:2:0 format;

means for splitting the coding unit for the chroma component into a first triangle-shaped partition and a second triangle-shaped partition based on enabling of a triangular prediction unit mode; and

means for applying pixel blending using a set of weights for the YUV 4:2:0 format to generate a predicted block for the chroma component when the one or more processors generate the coding unit for the chroma component in the YUV 4:2:0 format and when the one or more processors generate the coding unit for the chroma component in the YUV 4:4:4 format, wherein the means for applying pixel blending comprises means for determining weighted averages, using the set of weights for the YUV 4:2:0 format, of collocated motion compensated pixels of the first triangle-shaped partition and the second triangle-shaped partition based on motion information of the first triangle-shaped partition and the second triangle-shaped partition, respectively.

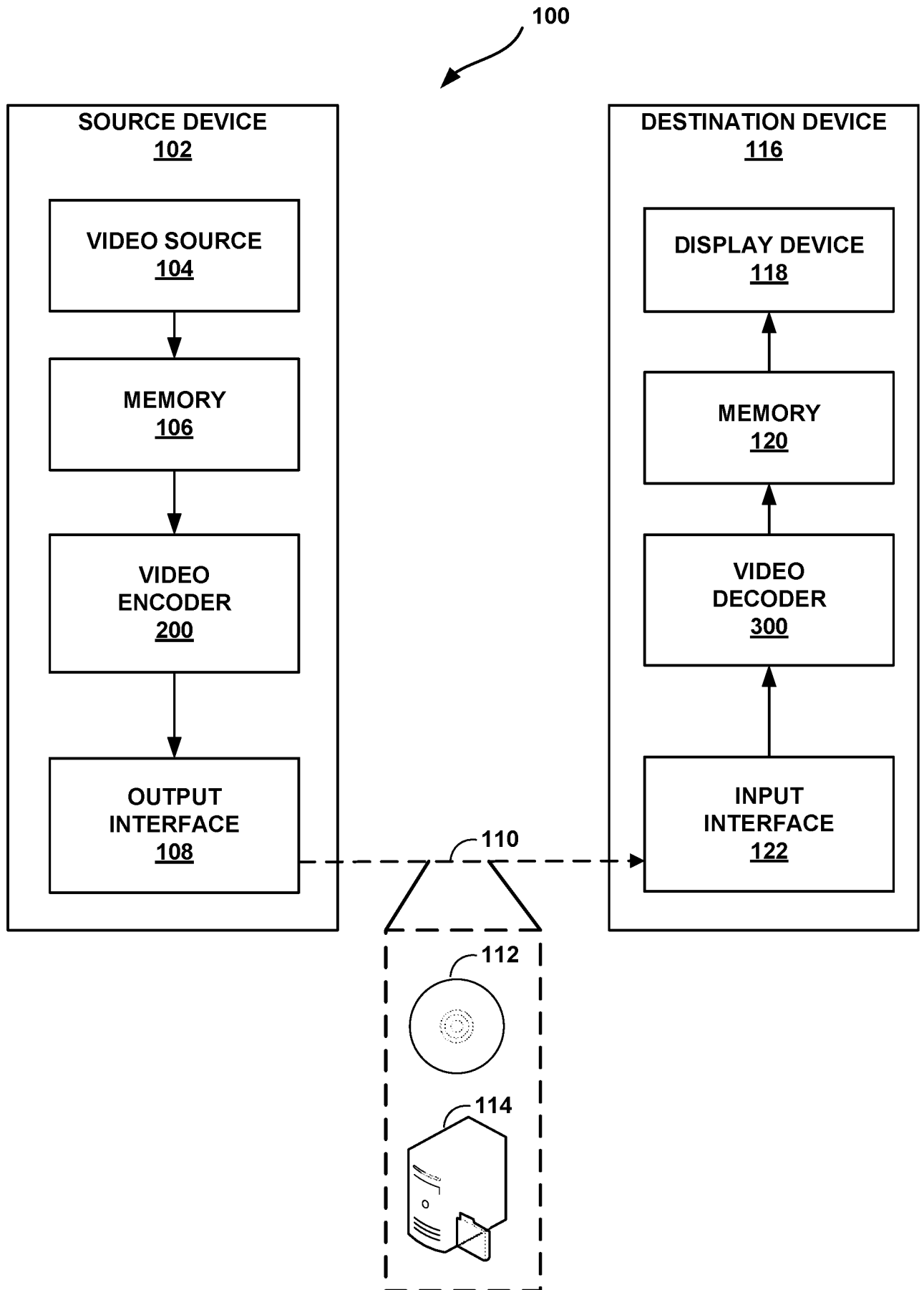

FIG. 1

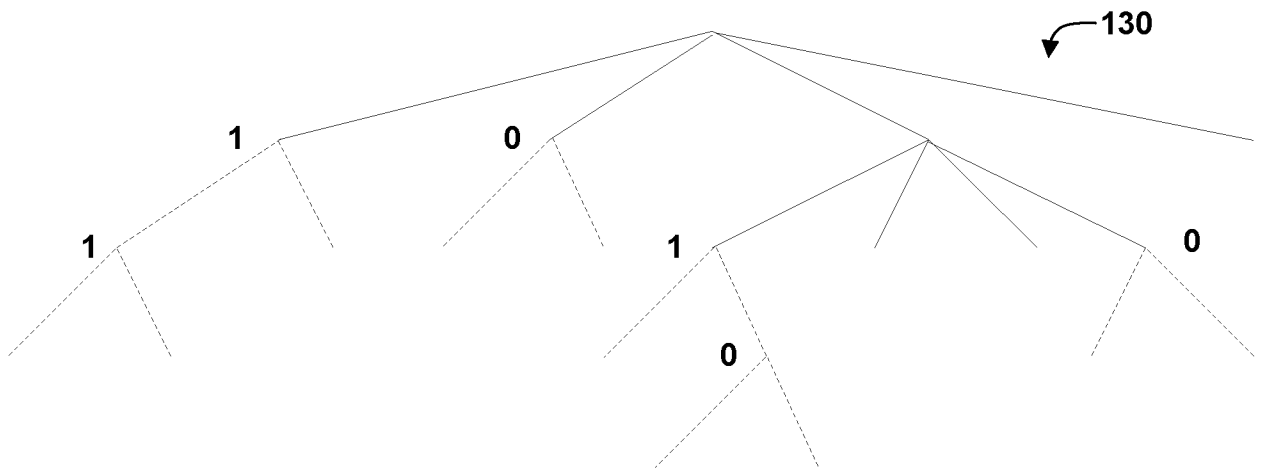

FIG. 2A

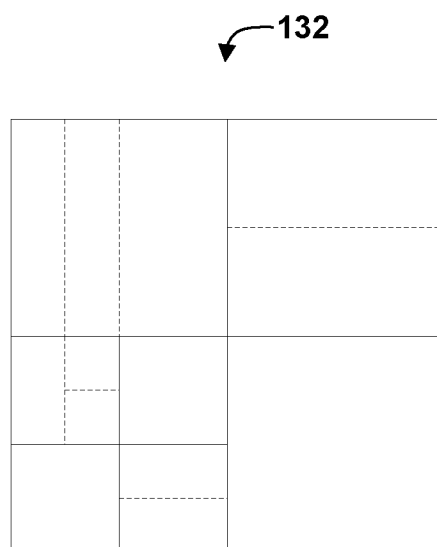

FIG. 2B

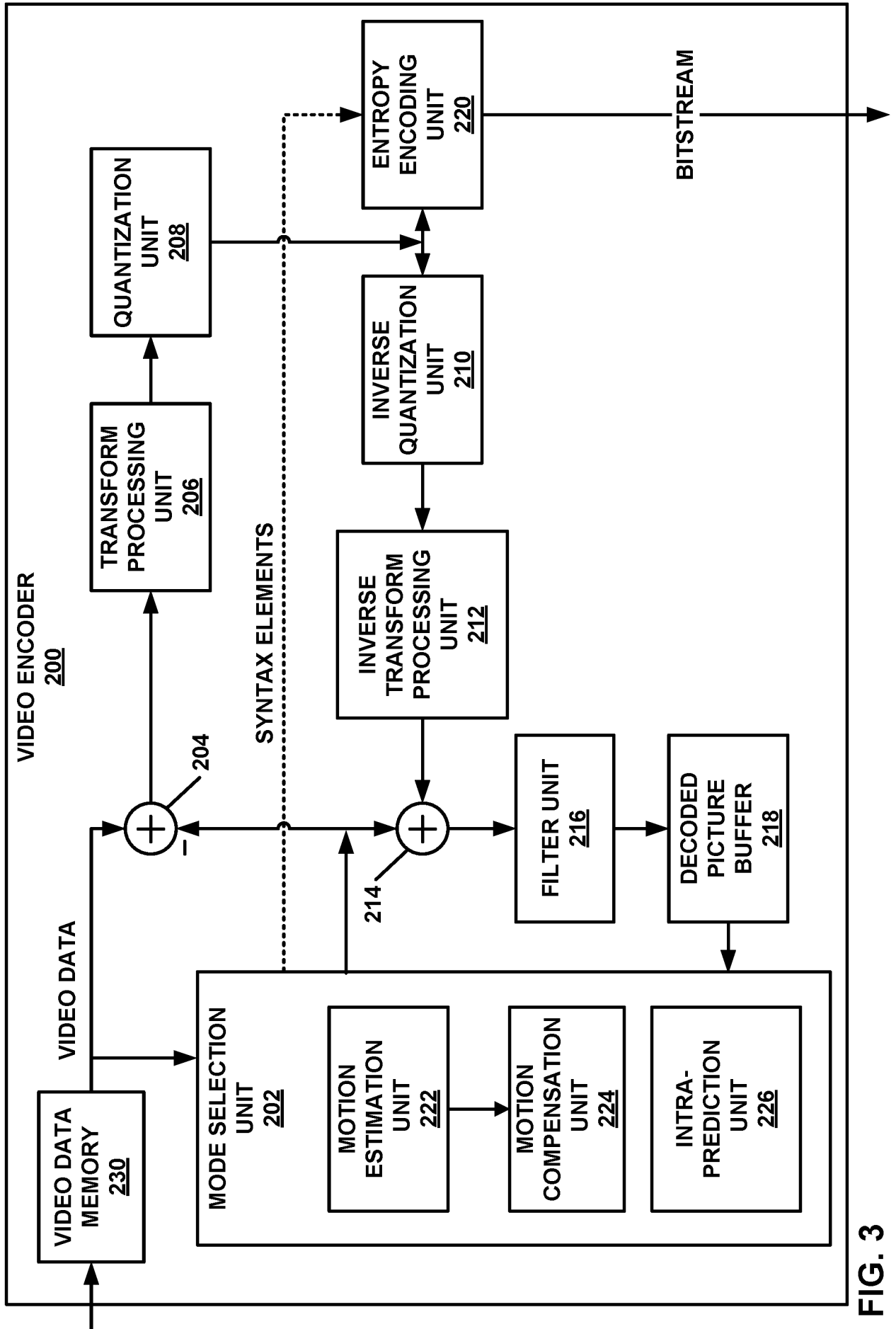

FIG. 3

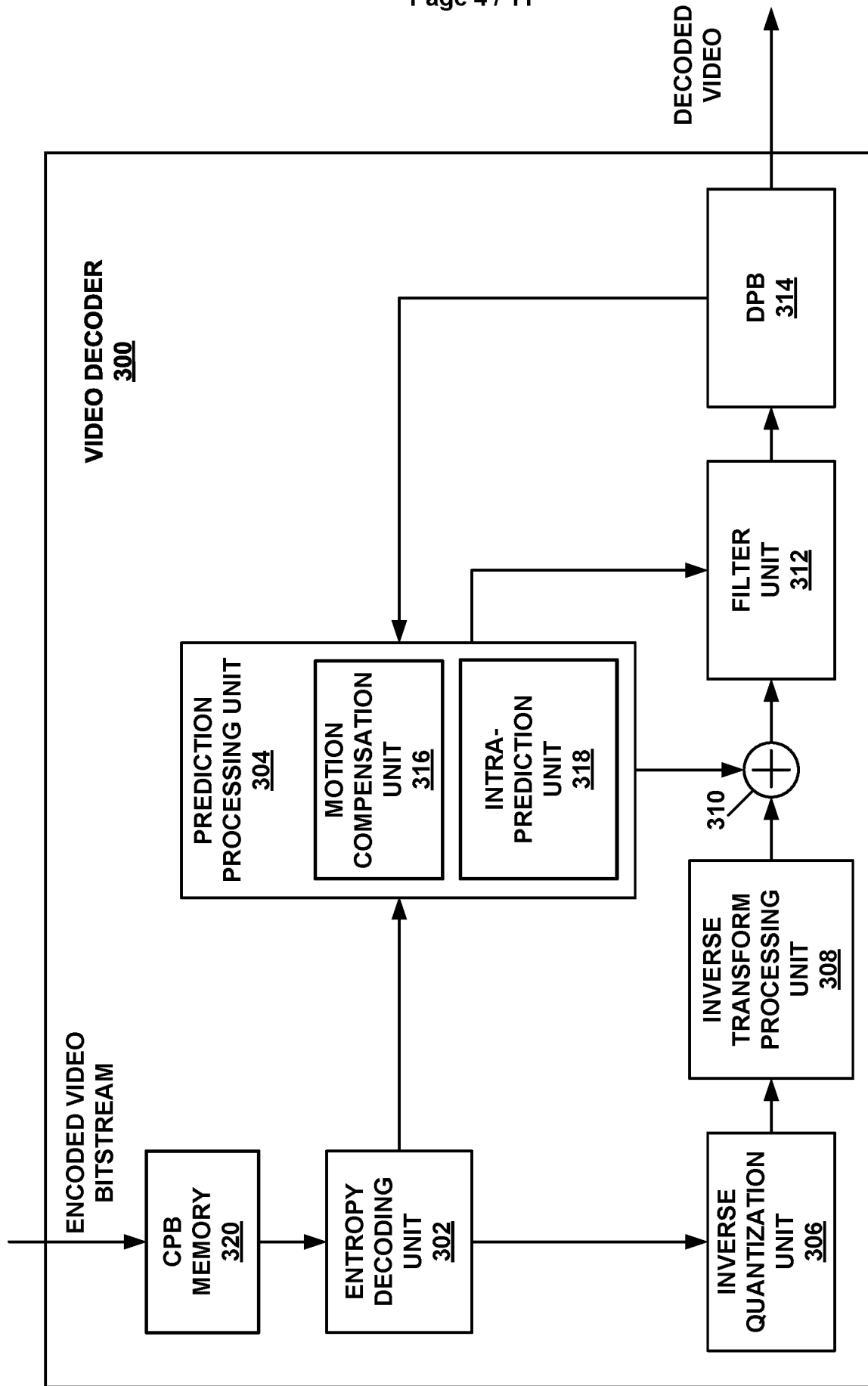

FIG. 4

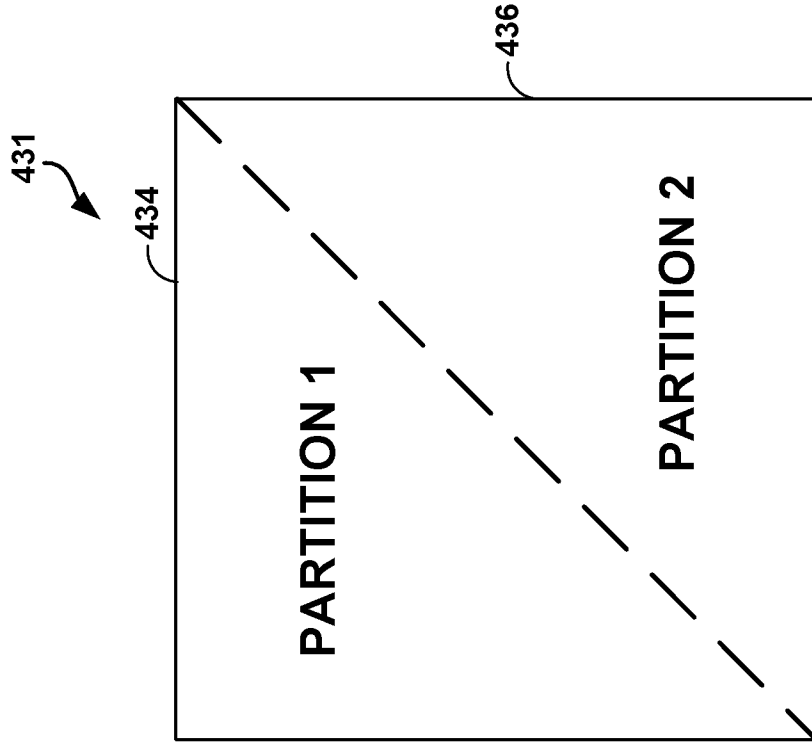

FIG. 5B

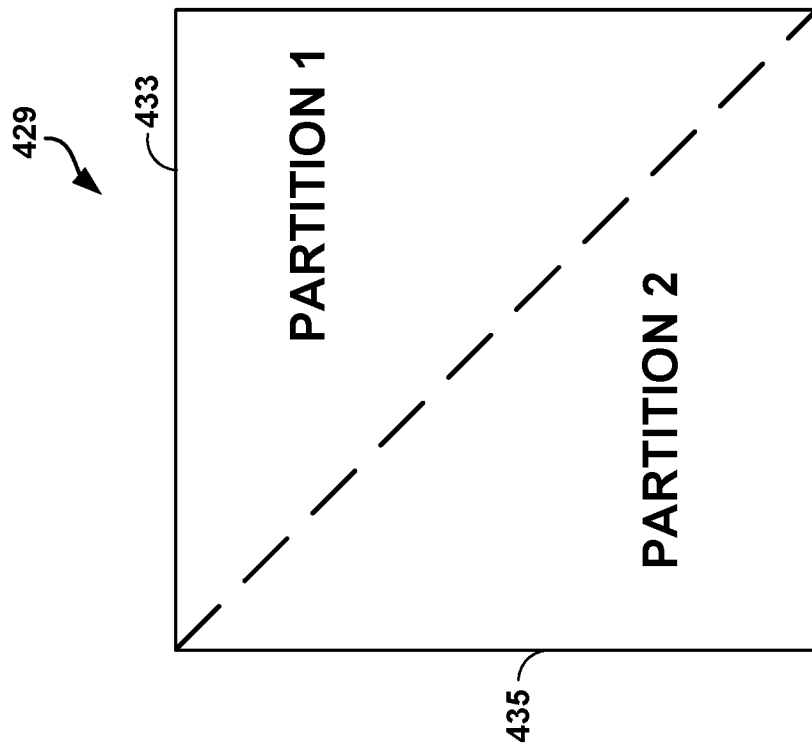

FIG. 5A

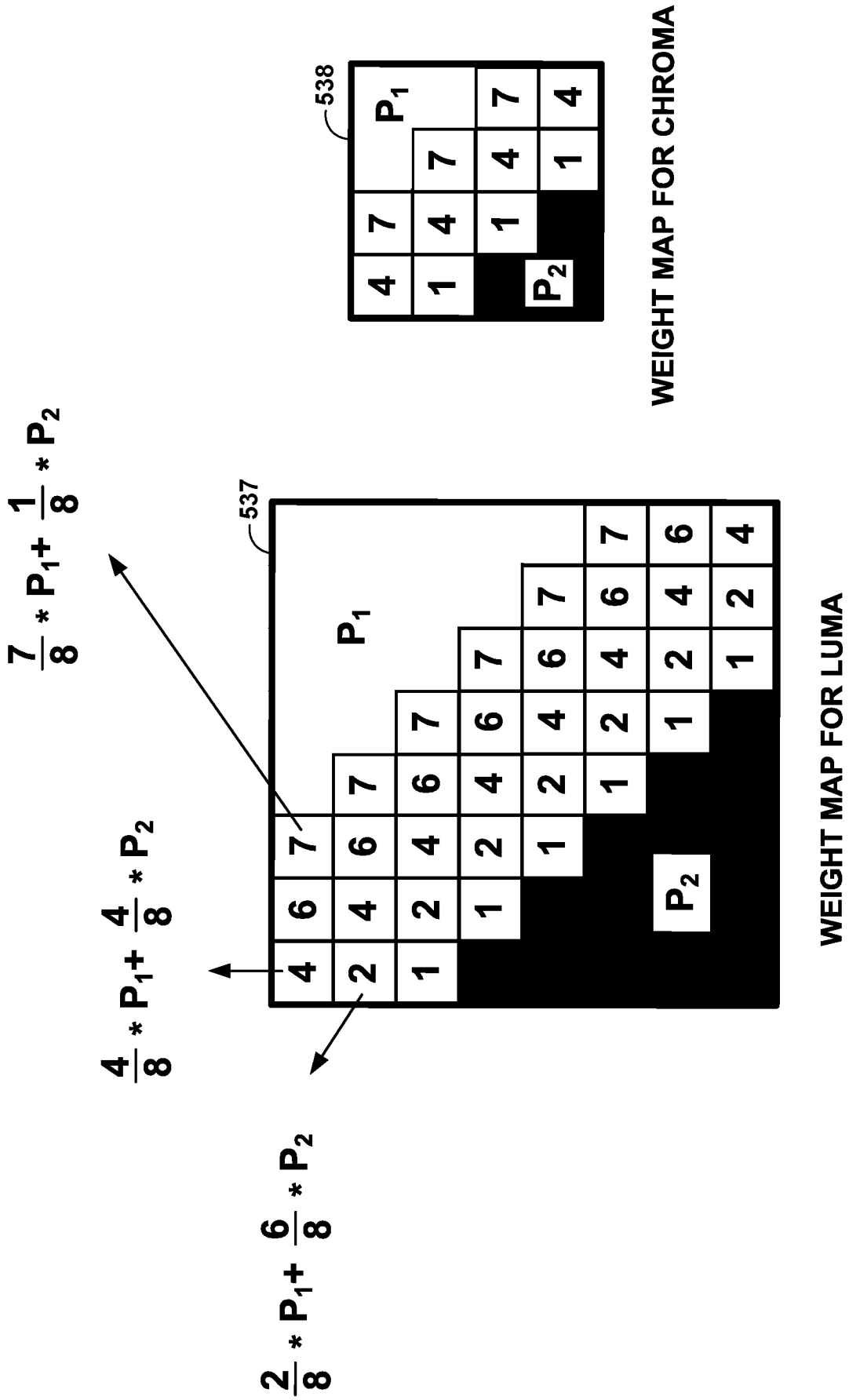

FIG. 6

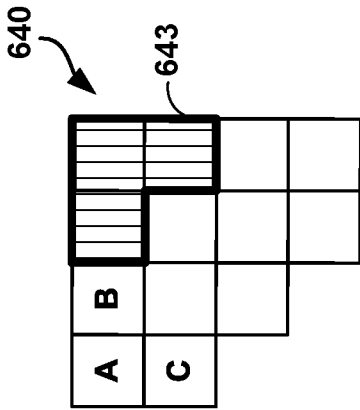

FIG. 7B

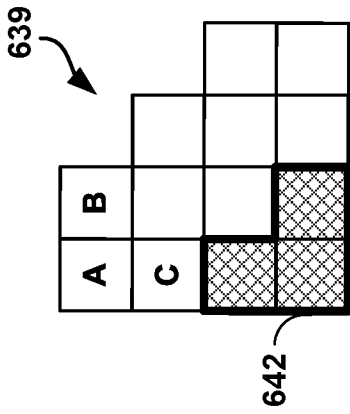

FIG. 7A

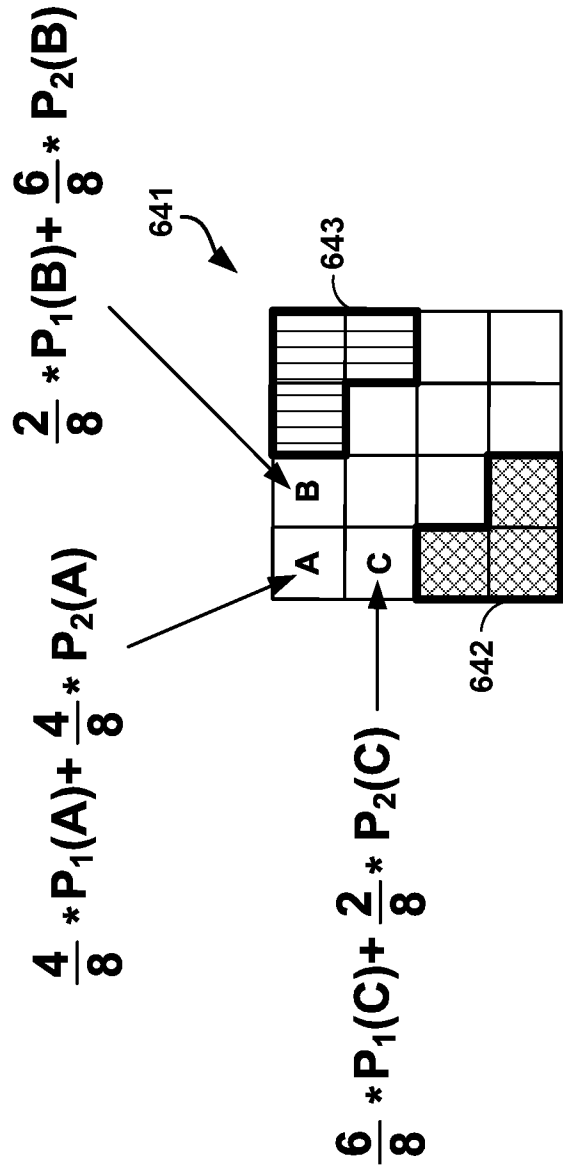

FIG. 7C

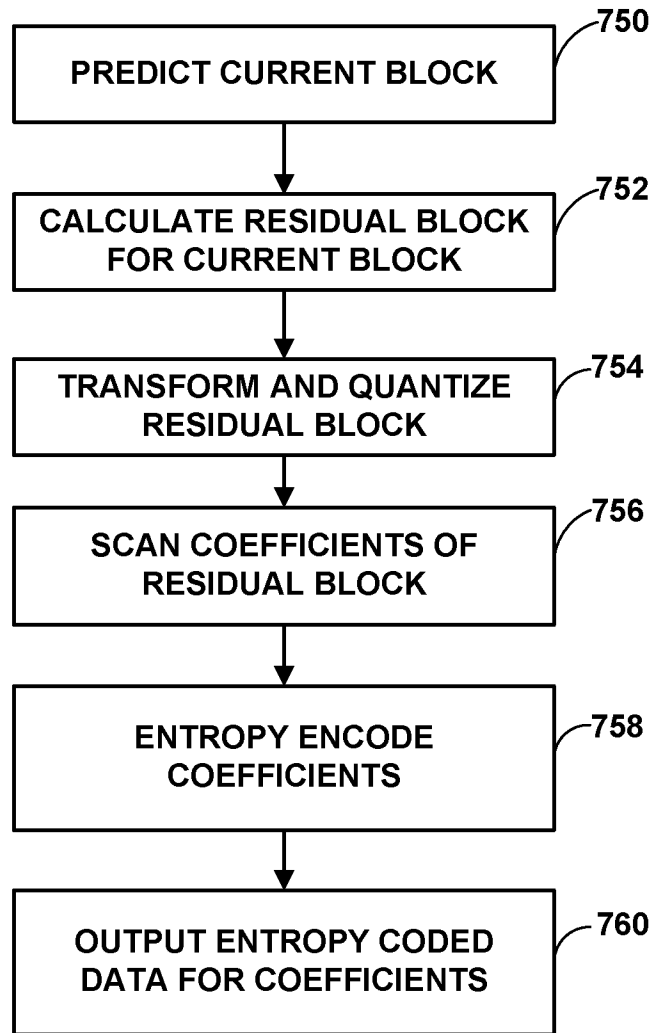

FIG. 8

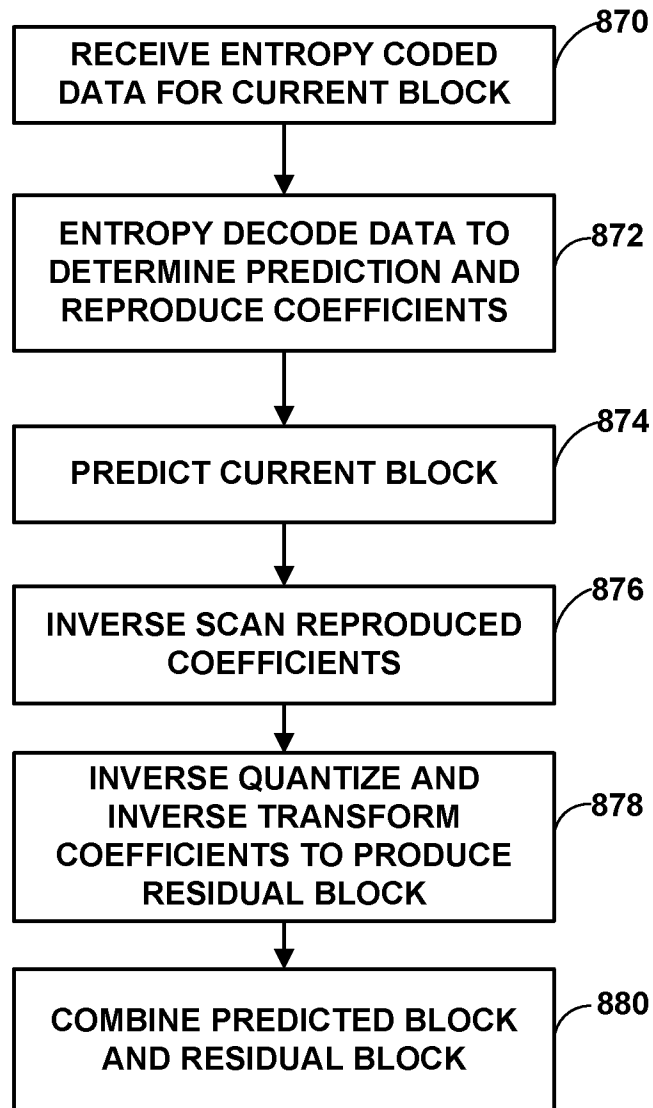

FIG. 9

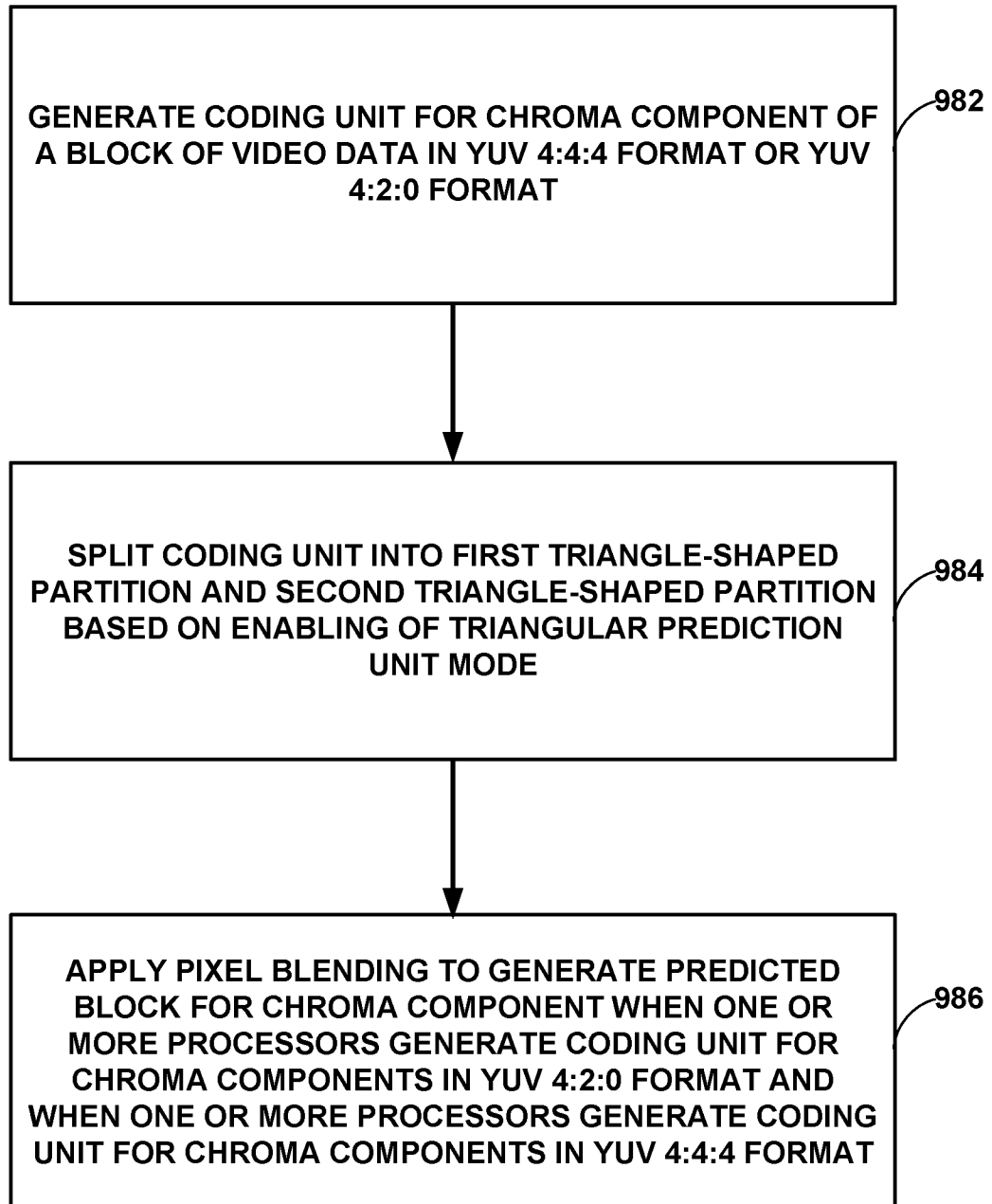

FIG. 10

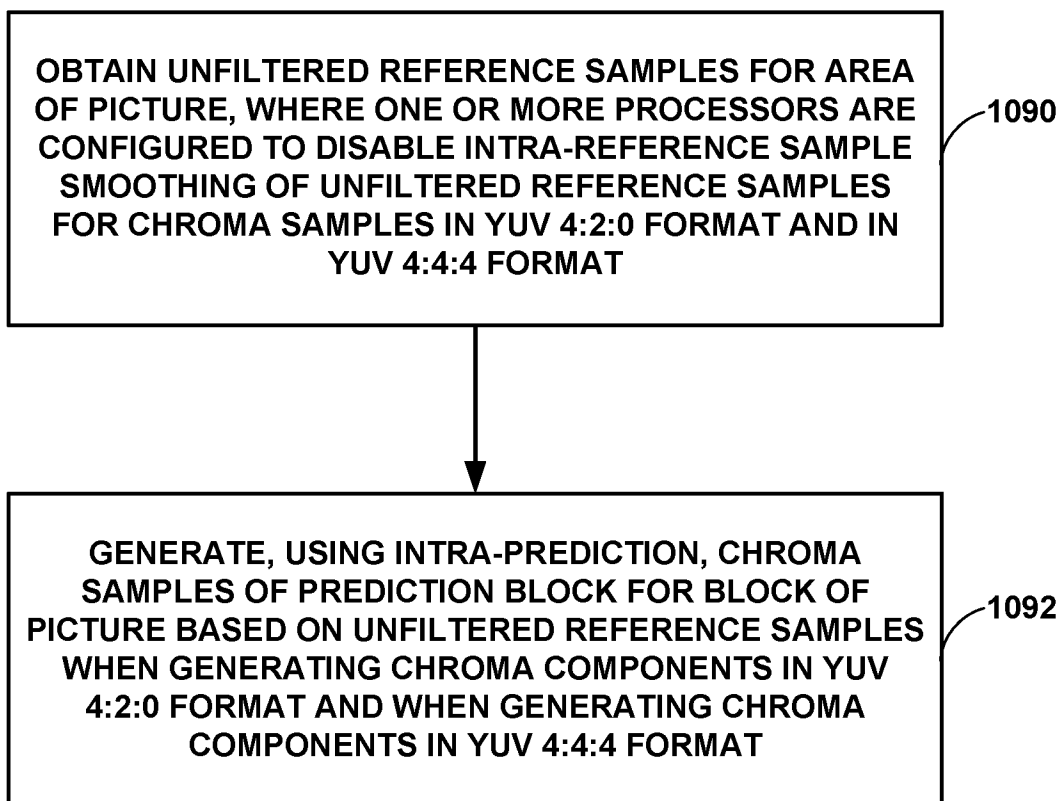

FIG. 11

INTERNATIONAL SEARCH REPORT

International application No
PCT/US2020/019945

A. CLASSIFICATION OF SUBJECT MATTER
INV. H04N19/117 H04N19/157 H04N19/186 H04N19/54
ADD.
According to International Patent Classification (IPC) or to both national classification and IPC

B. FIELDS SEARCHED
Minimum documentation searched (classification system followed by classification symbols)
H04N
Documentation searched other than minimum documentation to the extent that such documents are included in the fields searched

Electronic data base consulted during the international search (name of data base and, where practicable, search terms used)
EPO-Internal, WPI Data, COMPENDEX, INSPEC

C. DOCUMENTS CONSIDERED TO BE RELEVANT

Category*	Citation of document, with indication, where appropriate, of the relevant passages	Relevant to claim No.
X	R-L LIAO (PANASONIC) ET AL: "CE10.3.1.b: Triangular prediction unit mode", 12. JVET MEETING; 20181003 - 20181012; MACAO; (THE JOINT VIDEO EXPLORATION TEAM OF ISO/IEC JTC1/SC29/WG11 AND ITU-T SG.16), , no. JVET-L0124 1 November 2018 (2018-11-01), XP030198593, Retrieved from the Internet: URL:http://phenix.int-evry.fr/jvet/doc_end_user/documents/12_Macao/wg11/JVET-L0124-v6.zip JVET-L0124-v2.doc [retrieved on 2018-11-01] abstract Section 1; Figure 3 ----- -/--	1-19

Further documents are listed in the continuation of Box C.

See patent family annex.

* Special categories of cited documents :

- "A" document defining the general state of the art which is not considered to be of particular relevance
- "E" earlier application or patent but published on or after the international filing date
- "L" document which may throw doubts on priority claim(s) or which is cited to establish the publication date of another citation or other special reason (as specified)
- "O" document referring to an oral disclosure, use, exhibition or other means
- "P" document published prior to the international filing date but later than the priority date claimed

- "T" later document published after the international filing date or priority date and not in conflict with the application but cited to understand the principle or theory underlying the invention
- "X" document of particular relevance; the claimed invention cannot be considered novel or cannot be considered to involve an inventive step when the document is taken alone
- "Y" document of particular relevance; the claimed invention cannot be considered to involve an inventive step when the document is combined with one or more other such documents, such combination being obvious to a person skilled in the art
- "&" document member of the same patent family

Date of the actual completion of the international search 29 May 2020	Date of mailing of the international search report 15/06/2020
--	--

Name and mailing address of the ISA/ European Patent Office, P.B. 5818 Patentlaan 2 NL - 2280 HV Rijswijk Tel. (+31-70) 340-2040, Fax: (+31-70) 340-3016	Authorized officer Morbee, Marleen
--	---------------------------------------

INTERNATIONAL SEARCH REPORT

International application No
PCT/US2020/019945

C(Continuation). DOCUMENTS CONSIDERED TO BE RELEVANT		
Category*	Citation of document, with indication, where appropriate, of the relevant passages	Relevant to claim No.
X	<p>R-L LIAO (PANASONIC) ET AL: "CE10: Triangular prediction unit mode (CE10.3.1 and CE10.3.2)", 11. JVET MEETING; 20180711 - 20180718; LJUBLJANA; (THE JOINT VIDEO EXPLORATION TEAM OF ISO/IEC JTC1/SC29/WG11 AND ITU-T SG.16), , no. JVET-K0144 10 July 2018 (2018-07-10), XP030199217, Retrieved from the Internet: URL:http://phenix.int-evry.fr/jvet/doc_end_user/documents/11_Ljubljana/wg11/JVET-K0144-v2.zip JVET-K0144-v2.docx [retrieved on 2018-07-10] abstract Section 1; Figure 2</p>	1-19
X,P	<p>-----</p> <p>WANG (QUALCOMM) H ET AL: "Modifications to support the YUV 4:4:4 chroma format", 126. MPEG MEETING; 20190325 - 20190329; GENEVA; (MOTION PICTURE EXPERT GROUP OR ISO/IEC JTC1/SC29/WG11), , no. m47076 18 March 2019 (2019-03-18), XP030210590, Retrieved from the Internet: URL:http://phenix.int-evry.fr/mpeg/doc_end_user/documents/126_Geneva/wg11/m47076-JVE T-N0414-v3-JVET-N0414-v3.zip JVET-N0414-v3.docx [retrieved on 2019-03-18] abstract Section 2.3; Section 4</p>	1-19
A	<p>-----</p> <p>WANG (QUALCOMM) H ET AL: "Modifications to support the YUV 4:4:4 chroma format", 14. JVET MEETING; 20190319 - 20190327; GENEVA; (THE JOINT VIDEO EXPLORATION TEAM OF ISO/IEC JTC1/SC29/WG11 AND ITU-T SG.16), , no. JVET-N0414 13 March 2019 (2019-03-13), XP030203047, Retrieved from the Internet: URL:http://phenix.int-evry.fr/jvet/doc_end_user/documents/14_Geneva/wg11/JVET-N0414-v2.zip JVET-N0414-v2.docx [retrieved on 2019-03-13] the whole document</p> <p>-----</p>	1-19