



US00D441663S

(12) **United States Design Patent** (10) **Patent No.:** **US D441,663 S**  
**Streltsov** (45) **Date of Patent:** **\*\* May 8, 2001**

(54) **WATCH CASING AND BEZEL**  
(75) Inventor: **Sergei Streltsov**, London (GB)  
(73) Assignee: **Timex Corporation**, Middlebury, CT (US)  
(\*\*) Term: **14 Years**  
(21) Appl. No.: **29/126,655**  
(22) Filed: **Jul. 20, 2000**

D. 425,799 \* 5/2000 Hysek ..... D10/32  
D. 427,083 \* 6/2000 Yamamoto ..... D10/30  
D. 433,342 \* 11/2000 Fox ..... D10/30

\* cited by examiner

*Primary Examiner*—Nelson C. Holtje  
(74) *Attorney, Agent, or Firm*—Carmody & Torrance LLP

(57) **CLAIM**

The ornamental design for a watch casing and bezel, as shown and described.

**DESCRIPTION**

FIG. 1 is a perspective view of a watch casing and bezel showing my new design;  
FIG. 2 is a left side elevational view thereof;  
FIG. 3 is a top plan view thereof;  
FIG. 4 is a right side elevational view thereof;  
FIG. 5 is a first end elevational view thereof;  
FIG. 6 is a second end elevational view thereof; and,  
FIG. 7 is a bottom plan view.  
The broken line showings are for illustrative purposes only and form no part of the claimed design.

(51) **LOC (7) Cl.** ..... **10-02**  
(52) **U.S. Cl.** ..... **D10/30; D10/38**  
(58) **Field of Search** ..... D10/1-40, 122-132;  
368/280-282, 276-277, 28-30, 285, 239-242,  
82-84, 41-44

(56) **References Cited**  
**U.S. PATENT DOCUMENTS**

D. 383,396 \* 9/1997 Houlihan ..... D10/30  
D. 411,115 \* 6/1999 Houlihan et al. .... D10/30  
D. 415,708 \* 10/1999 Yanku ..... D10/128  
D. 418,442 \* 1/2000 Yanku ..... D10/128  
D. 424,451 5/2000 Houlihan .

**1 Claim, 4 Drawing Sheets**

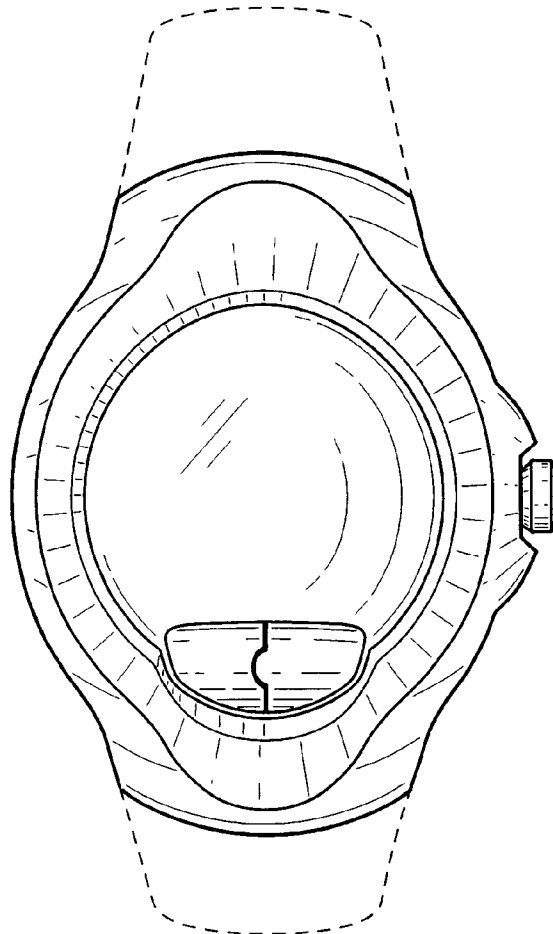

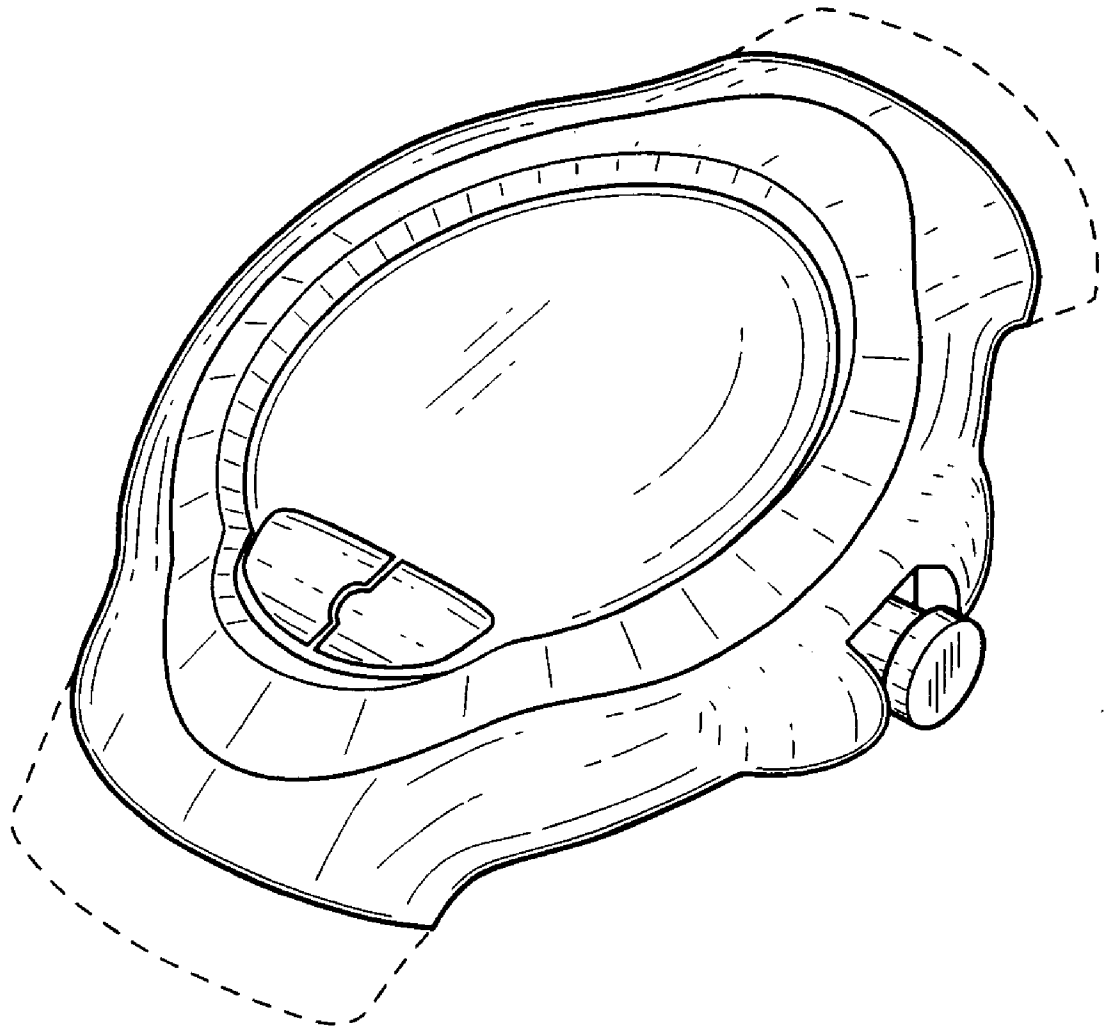

FIG. 1

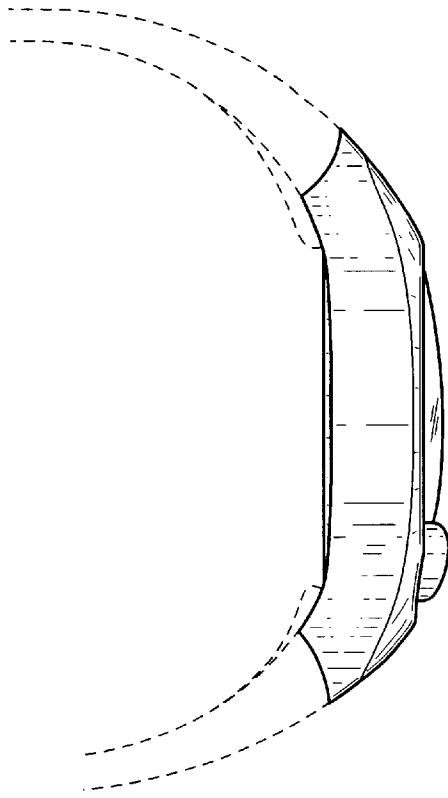

FIG. 2

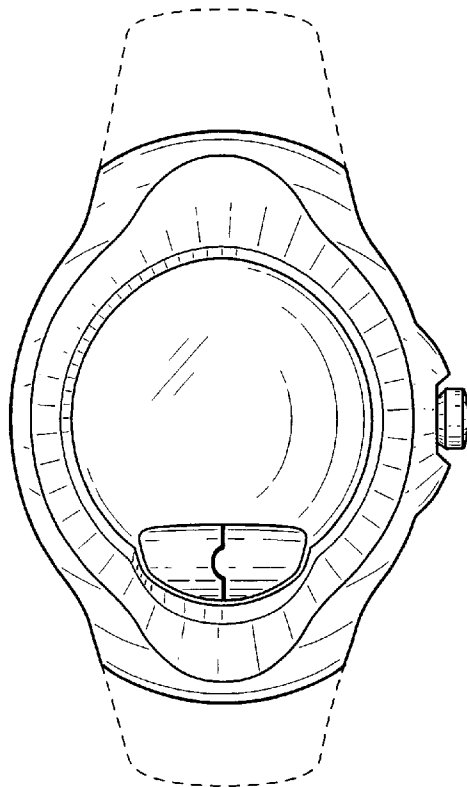

FIG. 3

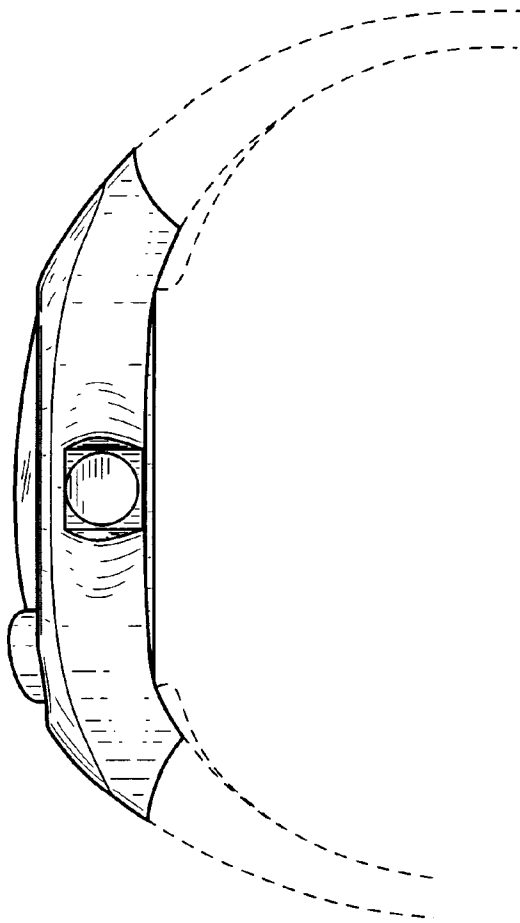

FIG. 4

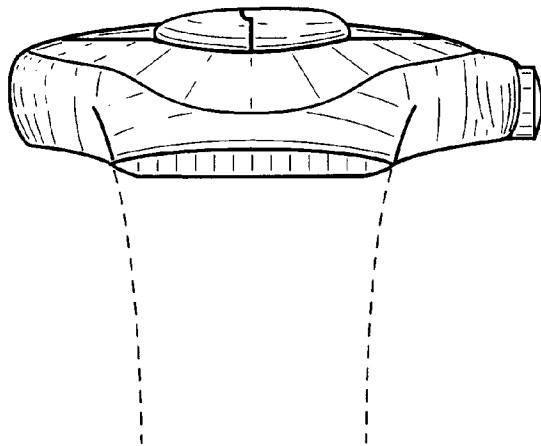

FIG. 5

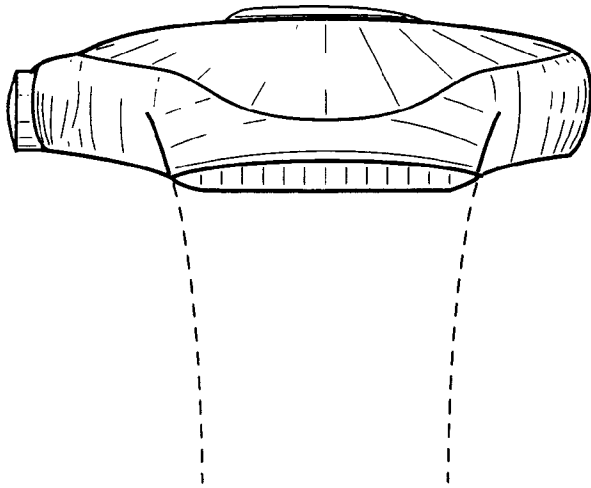

FIG. 6

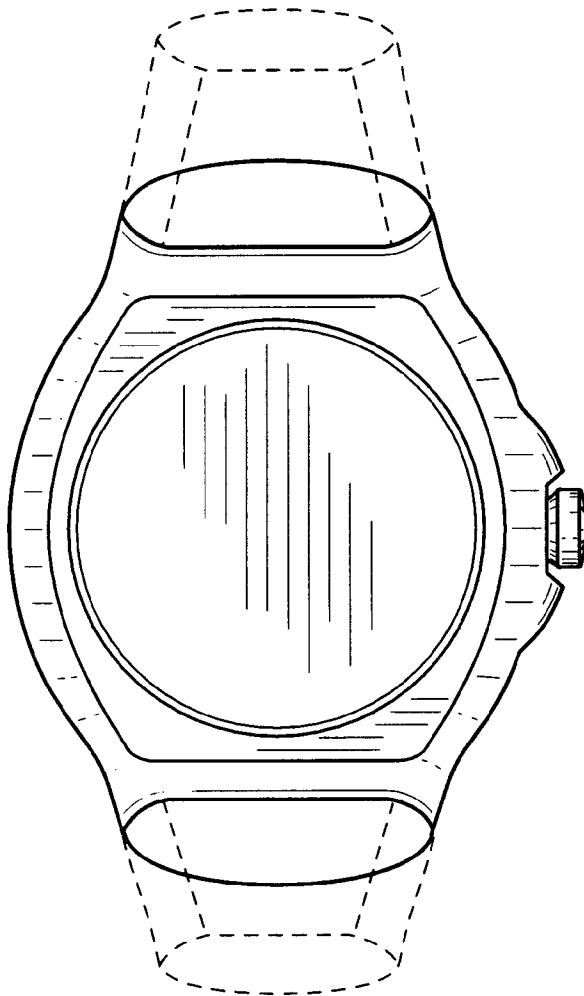

FIG. 7