



US00D534321S

(12) **United States Design Patent**
Simpson et al.

(10) **Patent No.:** **US D534,321 S**

(45) **Date of Patent:** **** Dec. 26, 2006**

(54) **PET LITTER PAN HOUSING**

(75) Inventors: **Jeffrey M. Simpson**, 381 Oak Ridge Dr., Auburn, AL (US) 36830; **Mark A. Haley**, Asheville, NC (US)

(73) Assignee: **Jeffrey M. Simpson**, Auburn, AL (US)

(**) Term: **14 Years**

(21) Appl. No.: **29/180,465**

(22) Filed: **Apr. 24, 2003**

(51) **LOC (8) Cl.** **30-99**

(52) **U.S. Cl.** **D30/161; D30/108; D30/118**

(58) **Field of Classification Search** D30/108-112, D30/114-118, 161; D3/314; 119/161, 163-170, 119/416-420, 428-430, 433, 435, 452-453, 119/459-460, 462-464, 467, 475, 482, 496-497, 119/311, 329, 28.5, 456, 493

See application file for complete search history.

(56) **References Cited**

U.S. PATENT DOCUMENTS

989,029 A	4/1911	Newcomb	
1,211,762 A	1/1917	Sawyer	
2,560,661 A	7/1951	Poovey	
2,789,531 A	4/1957	Diefendorf	
2,892,562 A	6/1959	Smithson	
3,738,322 A	6/1973	Smith	
3,774,929 A	11/1973	Stanley	
3,978,616 A	9/1976	Pennock	
4,027,625 A	6/1977	Wheeler	
D245,191 S	* 7/1977	Gore	D30/161
4,224,899 A	9/1980	Cruchelow et al.	
4,256,056 A	3/1981	Sou	
D287,650 S	1/1987	Braeuner	
4,696,259 A	9/1987	Fewox	
4,762,085 A	8/1988	Ondrasik	
4,763,606 A	* 8/1988	Ondrasik, II	119/474
D308,589 S	* 6/1990	Shay	D30/161
D310,740 S	* 9/1990	Mannschreck	D30/161
4,989,546 A	2/1991	Cannaday	
5,167,202 A	12/1992	Bradford et al.	
5,203,281 A	4/1993	Harwich	

5,249,549 A	10/1993	Rockaitis, III	
5,282,542 A	2/1994	Mo	
D347,304 S	* 5/1994	Hellem	D30/161
5,337,700 A	* 8/1994	Toft	119/168
5,469,807 A	11/1995	Kosmaczeska	
5,626,098 A	5/1997	Askins et al.	
5,649,500 A	7/1997	Klavemann et al.	

(Continued)

FOREIGN PATENT DOCUMENTS

GB 2 238 296 A 5/1991

OTHER PUBLICATIONS

In the Company of Dogs, Spring Preview 2001—Catalog, Portland, Tennessee; p. 8, Delux Sport Utility Tricycle with bamboo and rattan wrapped baskets for pets.

Primary Examiner—Cathy Anne MacCormac

(74) *Attorney, Agent, or Firm*—Gardner Groft Santos & Greenwald, P.C.

(57) **CLAIM**

The ornamental design for a pet litter pan housing, as shown and described.

DESCRIPTION

FIG. 1 is a perspective view of a litter pan housing according to one embodiment of the present design; FIG. 2 is a front view of the litter pan housing of FIG. 1; FIG. 3 is a right side view of the litter pan housing of FIG. 1, the left side being a mirror image; FIG. 4 is a back view of the litter pan housing of FIG. 1; FIG. 5 is a top view of the litter pan housing of FIG. 1; FIG. 6 is a bottom view of the litter pan housing of FIG. 1; FIG. 7 is a perspective view of a litter pan housing according to another embodiment of the present design; FIG. 8 is a front view of the litter pan housing of FIG. 7; FIG. 9 is a right side view of the litter pan housing of FIG. 7, the left side being a mirror image; FIG. 10 is a back view of the litter pan housing of FIG. 7; FIG. 11 is a top view of the litter pan housing of FIG. 7; and, FIG. 12 is a bottom view of the litter pan housing of FIG. 7.

1 Claim, 12 Drawing Sheets

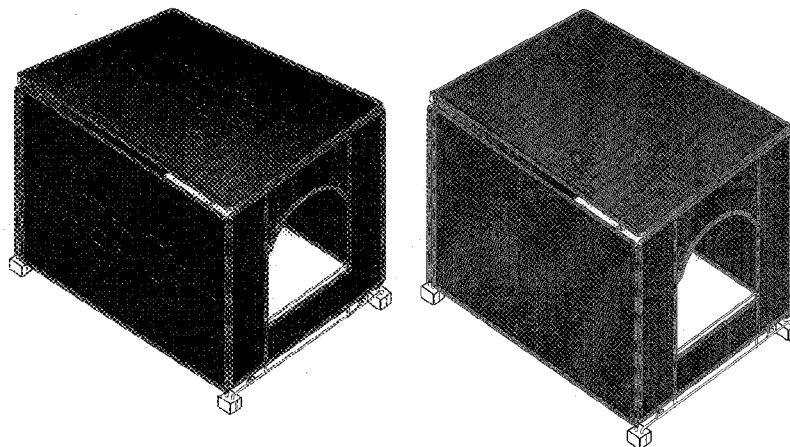

U.S. PATENT DOCUMENTS

D382,374 S	8/1997	Burks	6,192,834 B1	2/2001	Kolozsvari	
5,669,331 A	9/1997	Richmond	D442,748 S	5/2001	Farrugia	
5,845,970 A	12/1998	Schwartz	6,230,915 B1	5/2001	Liu	
5,890,455 A	4/1999	Donchey	6,318,294 B1	11/2001	Richmond et al.	
5,931,326 A	8/1999	Weng	6,354,245 B1	3/2002	Roddy et al.	
5,943,982 A	8/1999	Askins et al.	D467,041 S	* 12/2002	Cortes-Reuter	D30/109
5,960,744 A	10/1999	Rutman	D473,351 S	* 4/2003	Critchley	D30/161
5,967,090 A	10/1999	Hui	D483,156 S	12/2003	Simpson	
D427,730 S	7/2000	Powers et al.	D491,700 S	* 6/2004	Abajian	D30/161
6,131,534 A	10/2000	Axelrod	D501,584 S	* 2/2005	Abajian	D30/161

* cited by examiner

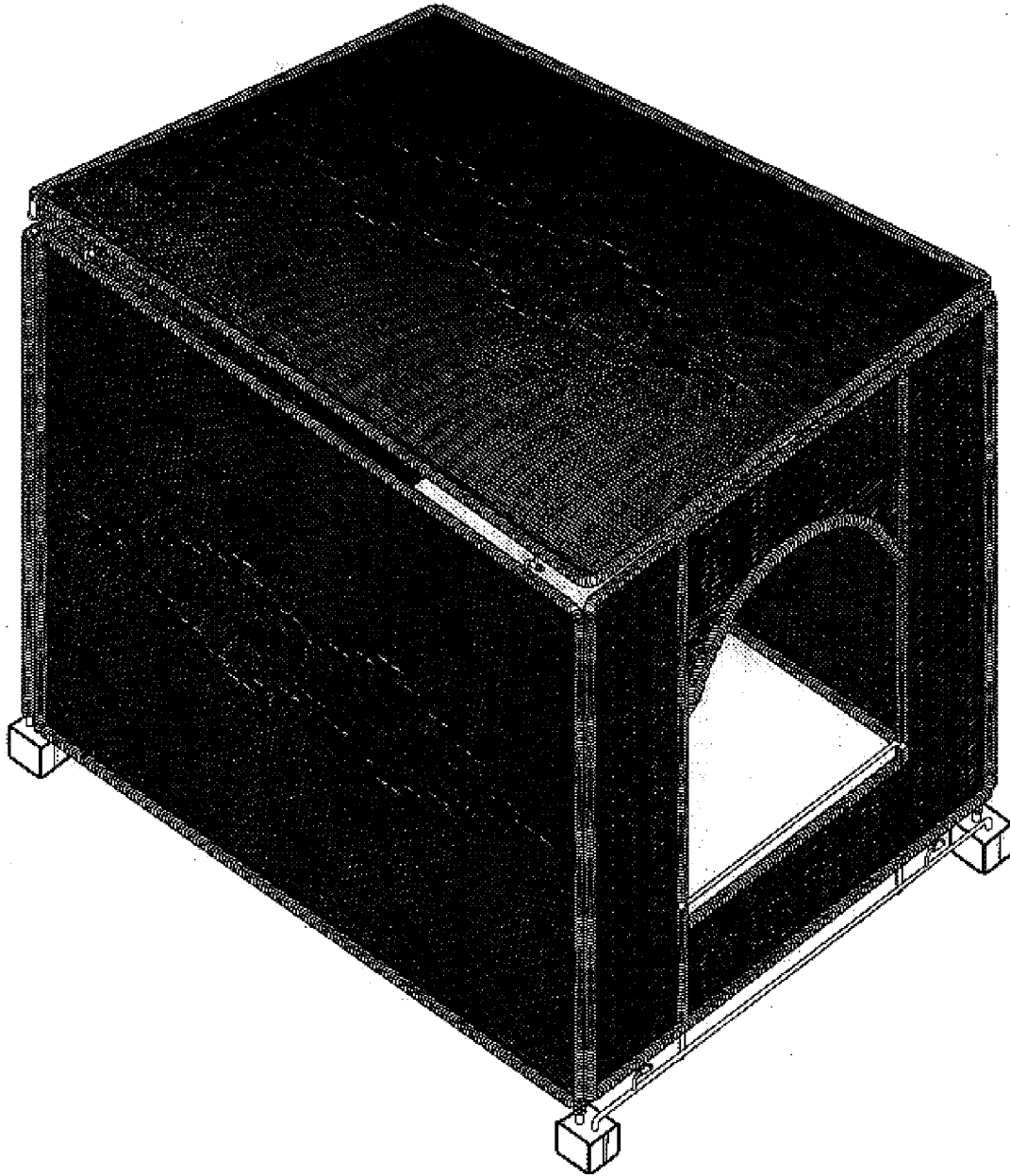

Fig. 1

Fig. 2

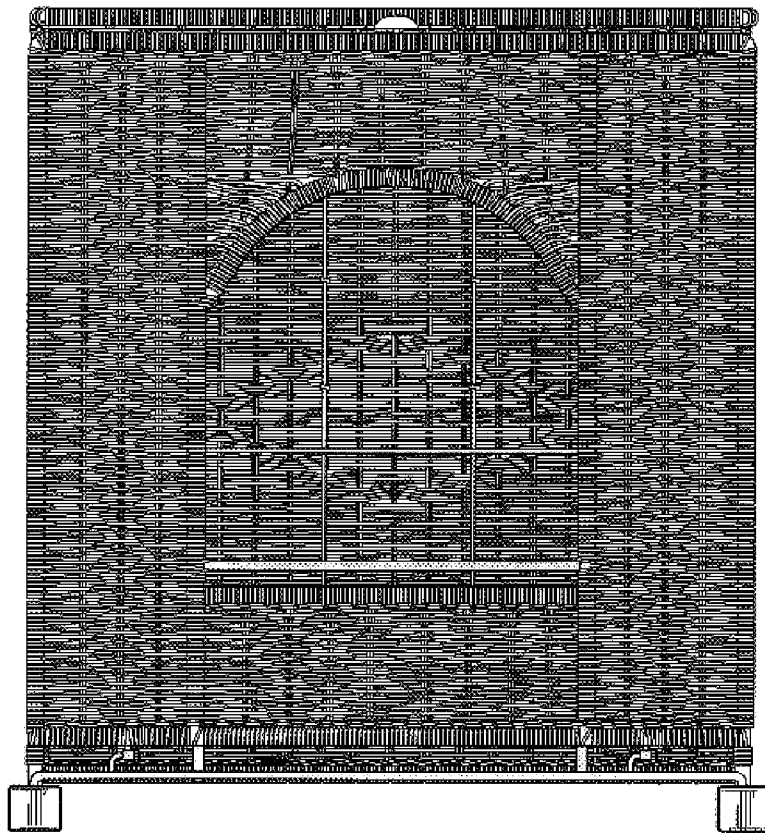

Fig. 3

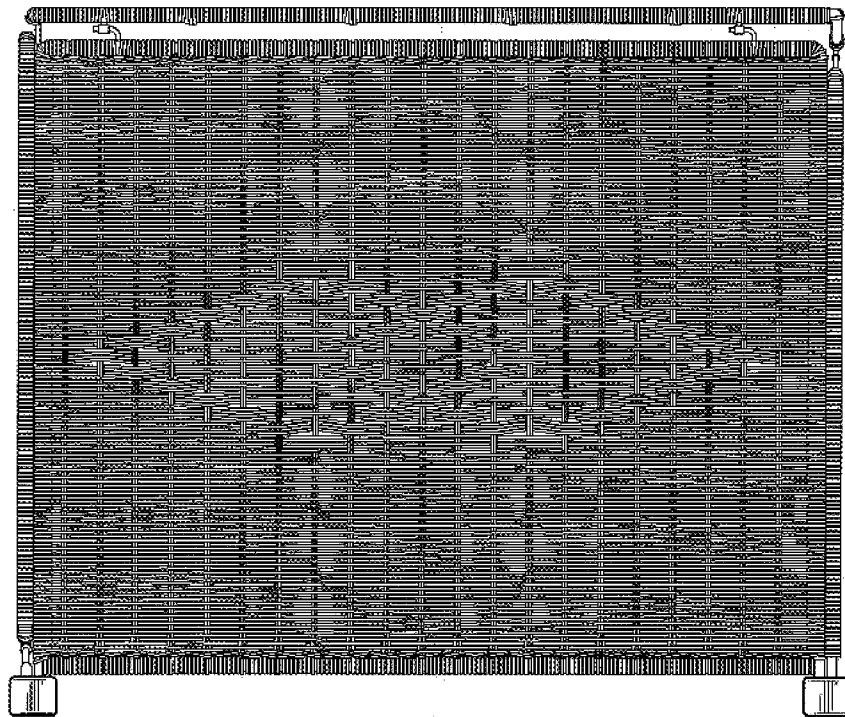

Fig. 4

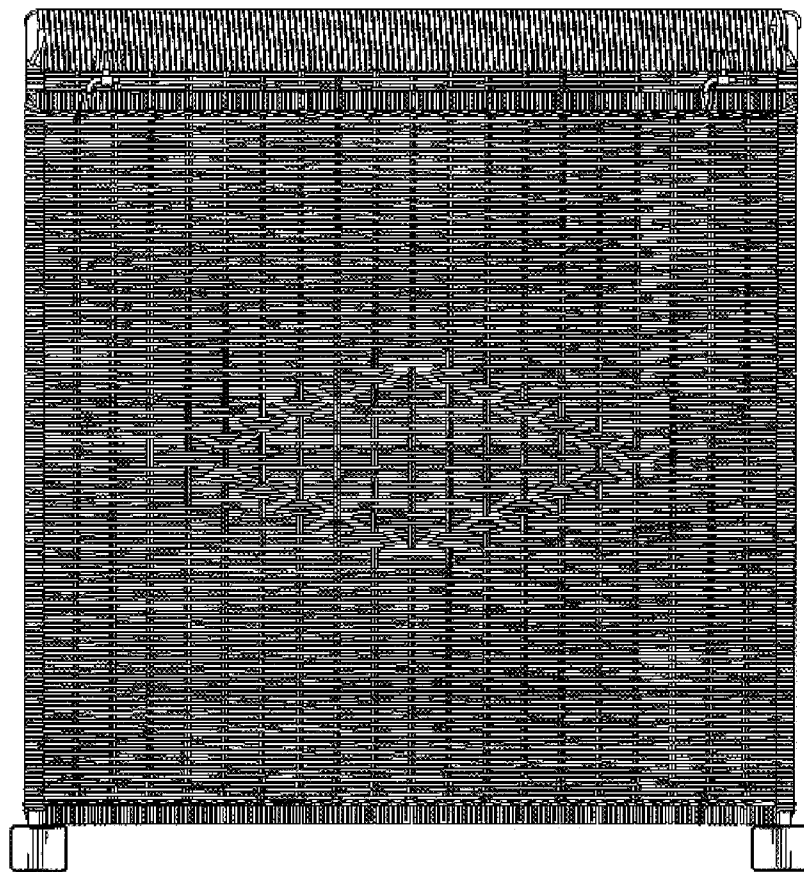

Fig. 5

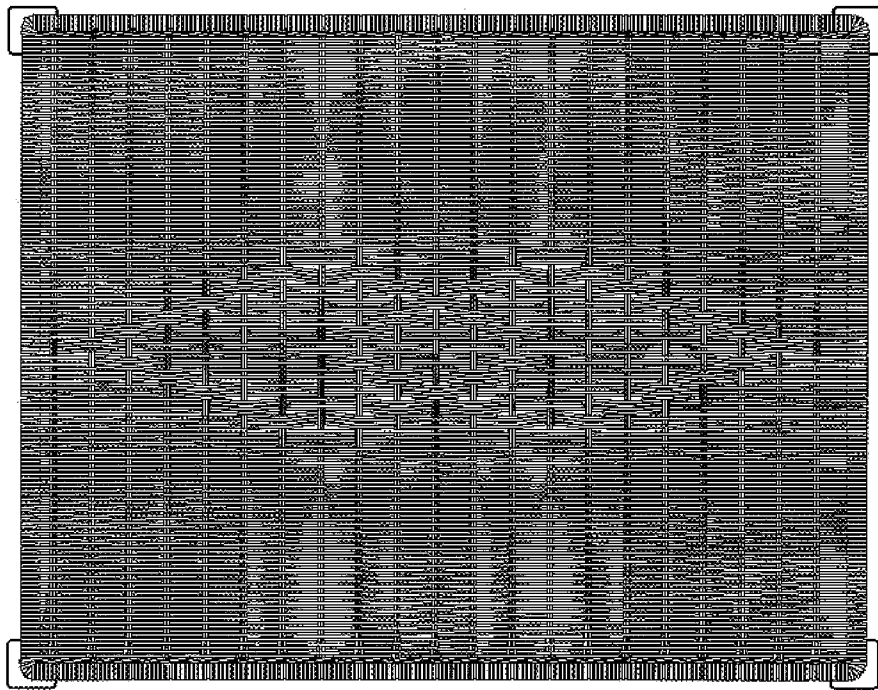
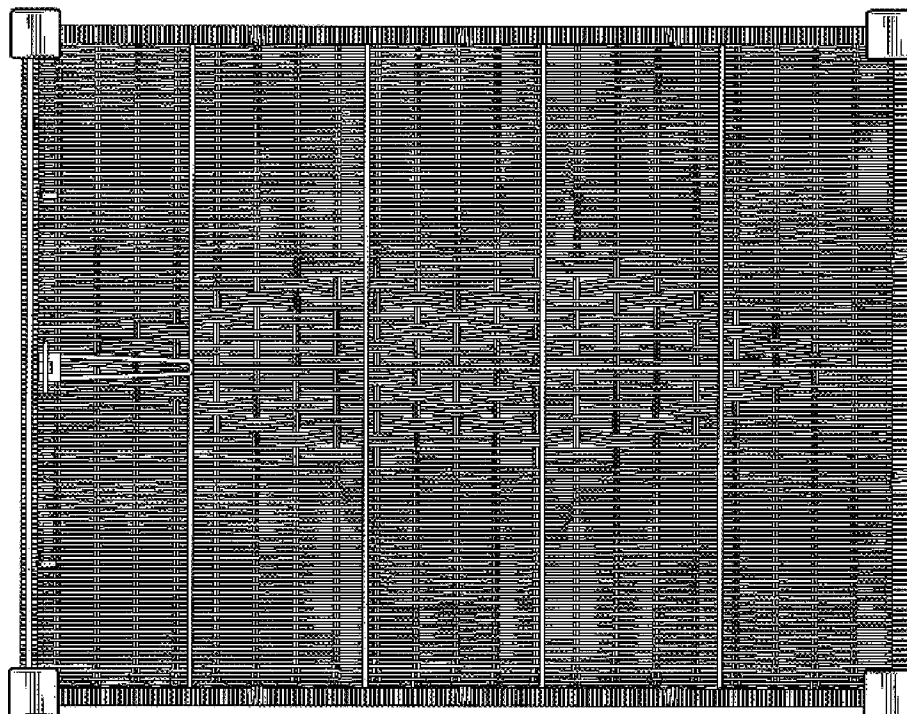

Fig. 6



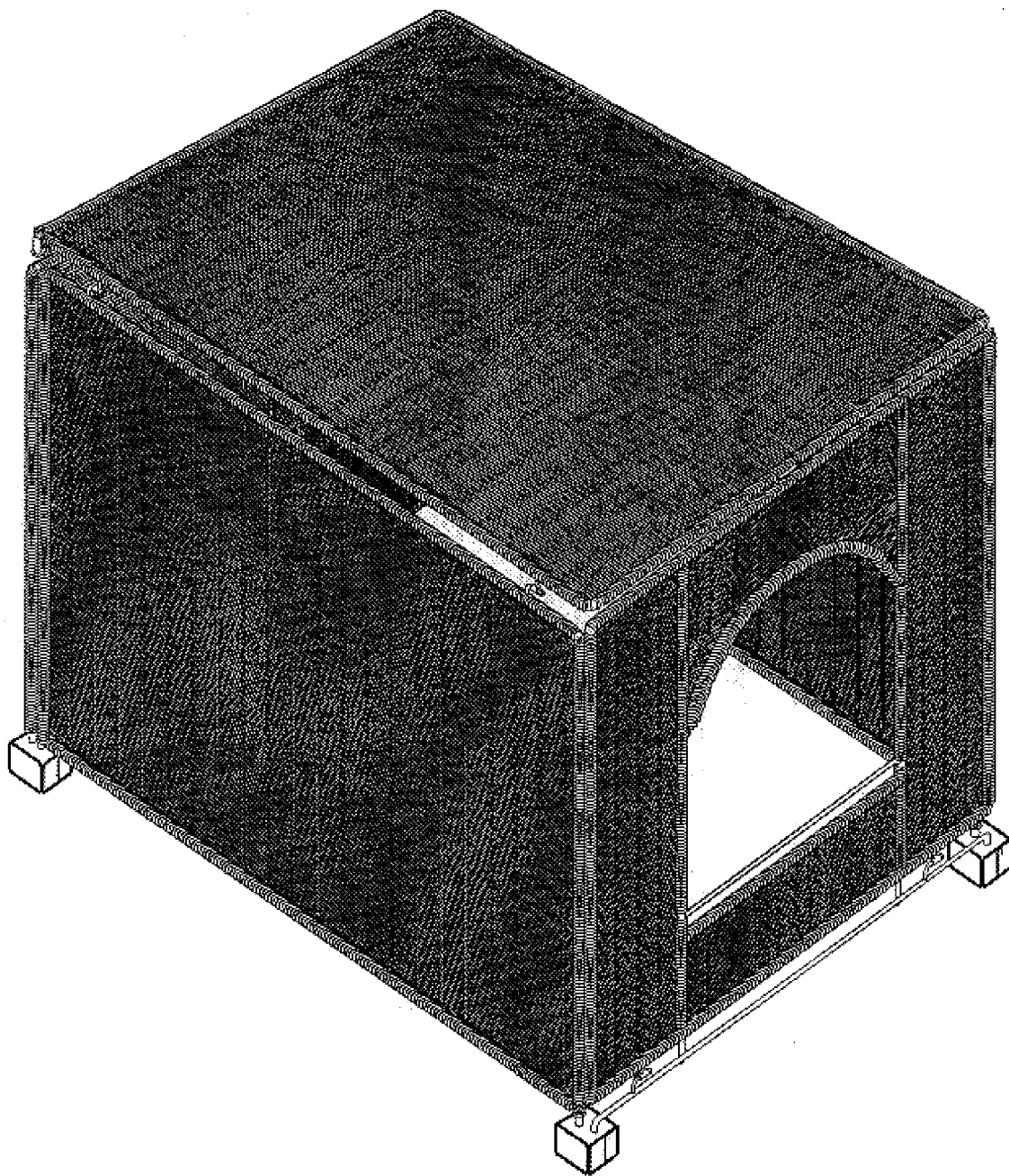

Fig. 1

Fig. 8

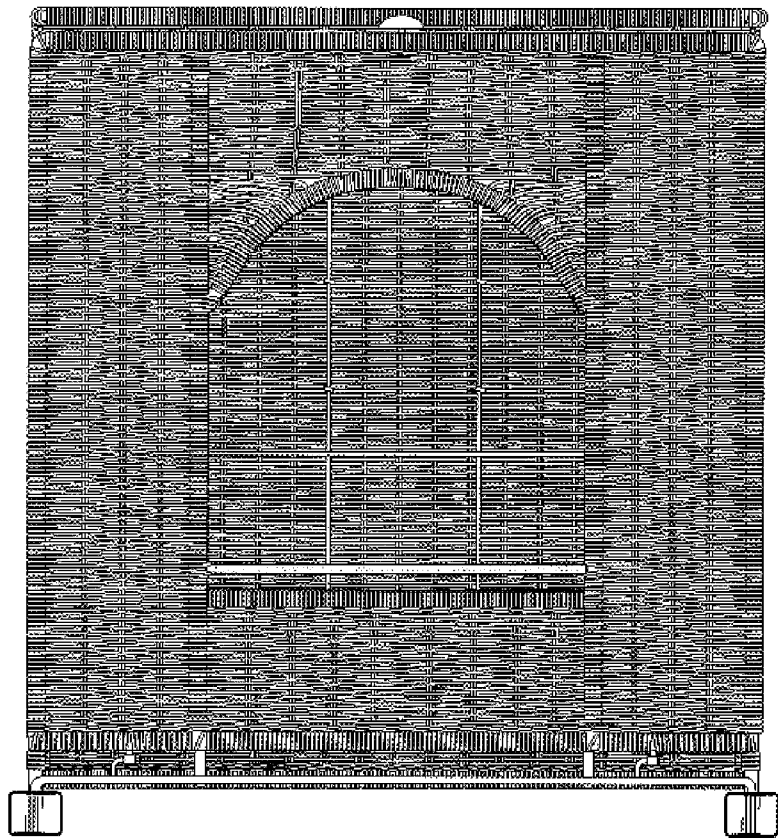

Fig. 9

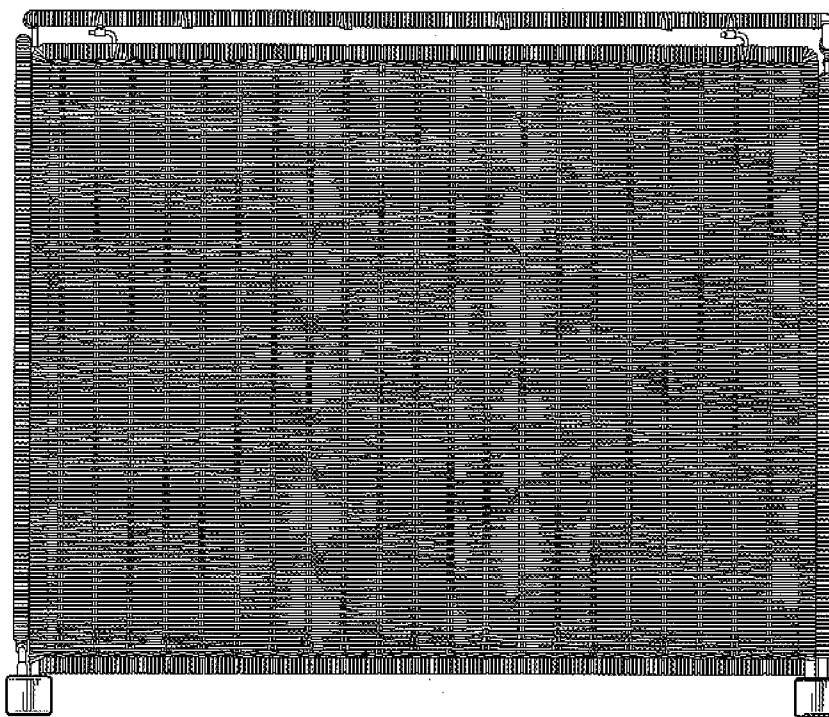

Fig. 10

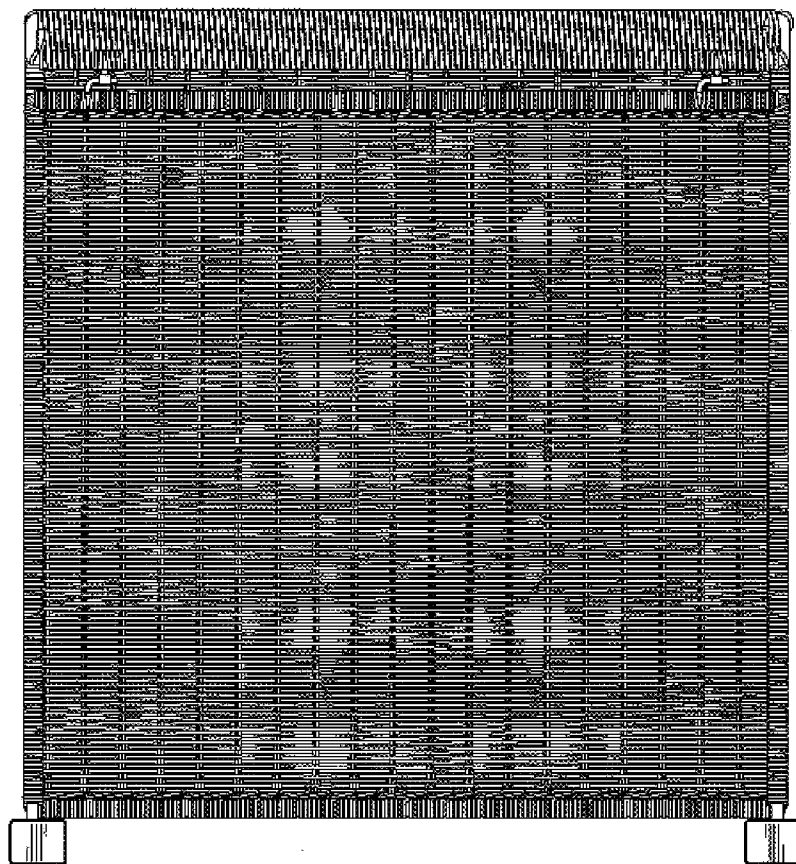

Fig. 11

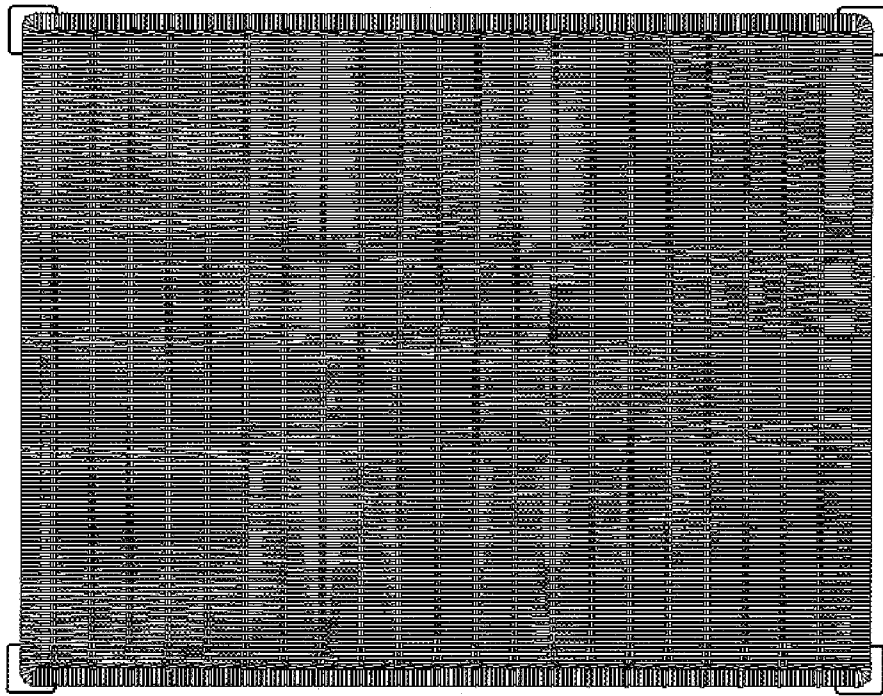

Fig. 12

