

12 EUROPEAN PATENT APPLICATION

21 Application number: 83307822.3

51 Int. Cl.³: A 43 B 3/00

22 Date of filing: 21.12.83

30 Priority: 30.03.83 US 480233

43 Date of publication of application:
10.10.84 Bulletin 84/41

84 Designated Contracting States:
BE DE FR GB IT NL

71 Applicant: Dana III, Alfred
5700 Mariner Drive Suite 205W
Tampa Florida 33609(US)

72 Inventor: Dana III, Alfred
5700 Mariner Drive Suite 205W
Tampa Florida 33609(US)

74 Representative: Arthur, Bryan Edward et al,
Withers & Rogers 4 Dyer's Buildings Holborn
London EC1N 2JT(GB)

54 Soft-soled safety shoe.

57 An illuminated sport shoe, particularly for running or jogging, is provided to enhance the safety of the wearer when running when visibility is poor. The shoe includes an upper, and an integral sole and heel piece of resilient material. A cavity is defined in the integral sole and heel piece adjacent the heel portion of the shoe, and a battery, or like source of e.m.f., is mounted in the cavity. A light source, such as an L.E.D., is mounted with the shoe, and one light source can be mounted in the integral sole and heel piece at the heel of the

shoe, and another in the upper at the toe portion of the shoe. An integrated circuit chip or mercury switch is provided to effect flashing of the light source when connected to the battery, and a switch is provided for operatively selectively connecting and disconnecting the light source to and from the battery. The chip and battery can be encapsulated in resilient material to provide an insert which has an interference fit with the walls defining the cavity in the integral sole and heel piece of the shoe.

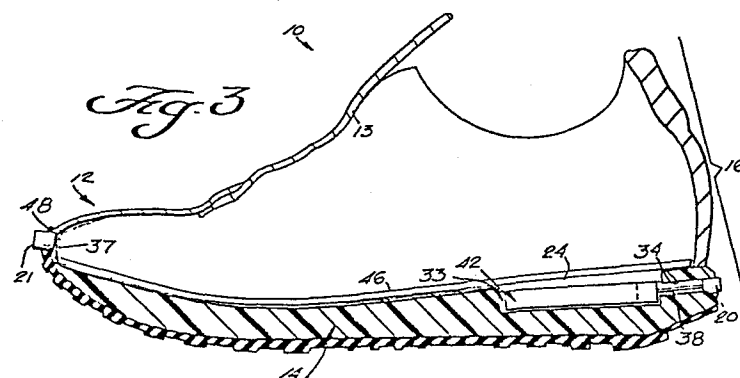

SOFT-SOLED SAFETY SHOEBACKGROUND AND SUMMARY OF THE INVENTION

In recent years there has been a dramatic increase in the number of people taking part in outdoor participant sports. Particularly, there has been a great increase in the number of people who
5 run or jog outdoors for sport, cardiovascular system conditioning, and the like. Many individuals run or job whenever their schedule permits, and this sometimes require jogging when it is dark, at dusk, or dawn, or under other conditions where visibility
10 is poor.

The increased incidence of joggers running at times of poor visibility has caused safety related problems, particularly collisions between joggers and motor vehicles. Safety concerns have
15 been heightened to such an extent that some municipalities already require that joggers wear reflective clothing, or the like, when running while visibility is poor.

It has been found that good visibility is
20 provided for joggers while running if a light source is provided associated with the jogger's shoes. The location of the light source near the ground, particularly where the light source flashes on and off, can provide maximum visibility, and thereby
25 minimize the chances for a vehicle-jogger collision.

According to the present invention a sport shoe is provided which is constructed to provide maximum visibility for a jogger by providing a light source associated with the jogger's shoes, while
30 minimizing adverse effects on the functionality of

the jogger's shoe due to incorporation of a light source therewith.

According to the present invention a sport shoe is provided comprising an upper and an integral sole and heel piece of resilient material. That is
5 the shoe comprises a conventional jogging shoe. Associated with the shoe, according to the present invention, is a source of e.m.f., a light source (such as an L.E.D. or light bulb) adapted to be
10 operatively connected to the source of e.m.f., means for mounting the light source to the shoe so that the light source is clearly visible from the exterior of the shoe, and means defining a cavity in the integral sole and heel piece for receipt of the
15 source of e.m.f. Switch means are provided for selectively connecting and disconnecting the source of e.m.f. to and from the light source.

According to the present invention it is also highly desirable to provide circuitry means for
20 providing flashing of the light source on and off when operatively connected to the source of e.m.f. Such flashing may be accomplished utilizing solid state oscillatory circuitry means, or by utilizing a mercury switch (or other tilt switch). Further,
25 according to the present invention the cavity is preferably defined adjacent the heel portion of the shoe, and the source of e.m.f. and circuitry means are encapsulated in a block of resilient material, which block of resilient material is inserted into
30 the cavity defined in the sole and heel piece so that the sole and heel have the same apparent configuration from the exterior thereof after mounting of the source of e.m.f. as prior to such mounting.

The switch means for selectively activating or deactivating the light sources may take a wide variety of forms, including a pressure operated switch inside the shoe, a switch on the side of the sole, and a common switch and light source.

For optimum visibility, the light source may be mounted directly at the back of the shoe in the integral heel and sole. Alternatively a light source could be mounted at the toe of the shoe, in the shoe upper. A light source mounted in both the toe and at the rear of the integral sole and heel would provide even greater visibility.

It is the primary object of the present invention to provide a sport shoe having good wearer visibility when used by a wearer under poor environmental visibility circumstances. This and other objects of the invention will become clear from an inspection of the detailed description of the invention, and from the appended claims.

BRIEF DESCRIPTION OF THE DRAWINGS

FIGURE 1 is a rear perspective view of a portion of an exemplary sport shoe according to the present invention;

FIGURE 2 is a front perspective view of a portion of an exemplary sport shoe according to the invention;

FIGURE 3 is a longitudinal cross-sectional view, with some components shown in elevation, of an exemplary sport shoe according to the present invention;

FIGURE 4 is a top plan view of an integral sole and heel component of the shoe of FIGURE 3, with the upper removed for clarity of illustration;

5 FIGURE 5 is a perspective view of an exemplary encapsulated insert utilizable in the shoe of FIGURE 3;

FIGURE 6 is an exemplary circuitry schematic for the shoe of FIGURE 3;

10 FIGURE 7 is a longitudinal cross-sectional view of an exemplary pressure actuated switch utilizable in the shoe of FIGURE 3; and

15 FIGURE 8 is a perspective view of a combined light source and switch actuator which may be utilizable in a sport shoe according to the present invention.

DETAILED DESCRIPTION OF THE DRAWINGS

20 An exemplary shoe according to the present invention is preferably a conventional sport shoe, such as a commercially available jogging shoe, such as shown in U.S. Patents 4,043,058, 4,128,950, or 4,255,877. The shoe, shown generally by reference
25 numeral 10 in FIGURES 1 through 3, includes an upper 12 including a tongue 13, and an integral sole and heel piece 14 of resilient material. Typically the sole or heel piece 14 is molded of one or more pieces of rubber, resilient plastic material, or the
30 like, to absorb impact as the wearer runs. The shoe 10 includes a toe portion, shown generally by reference numeral 15, and a heel portion, shown

generally by reference numeral 16 (see FIGURES 1 through 3).

According to the present invention the shoe 10 is provided with means for optimizing the visibility of the wearer when he/she is running at times of poor environmental visibility. Such means include a source of e.m.f., such as standard non-rechargeable, or rechargeable, batteries. A source of e.m.f. is illustrated schematically by reference numeral 18 in FIGURES 5 and 6, and in FIGURE 5 the means 18 are shown schematically in the form of two conventional AA batteries. It is to be understood, however, that any source of e.m.f. that can be incorporated in the shoe 10 is utilizable in the practice of the invention.

The sport shoe according to the invention also includes a light source adapted to be connected up to the source of e.m.f. 18. The light source may be one or more conventional light bulbs, L.E.D.s, or the like. In FIGURES 1 through 4 and 6, the light source is shown as a pair of L.E.D.s 20, 21.

The sport shoe according to the invention further includes switch means for selectively connecting and disconnecting the light source to and from the source of e.m.f. 18. In FIGURE 6 the switch means is shown generally by reference numeral 22 as a push button switch. The switch may be mounted in the integral sole and heel 14, as illustrated in FIGURES 1 and 4, or it may be provided in a number of other ways. For instance in place of, or in series with, the push button switch 22 a pressure activated switch 24 (see FIGURES 3 and 7) may be provided. The pressure activated switch 24, if utilized, is provided substantially directly under the heel of a wearer, and comprises a

conventional pressure actuated switch including a pair of contacts 25, 26 mounted to resilient (e.g. elastomeric) material 28, a force applied to the elastomeric material 28 causing the contacts 25, 26 to move together into mating relationship, which relationship is maintained as long as the pressure is applied to the elastomeric material 28.

In order to provide maximum visibility of the shoe wearer, circuitry means are provided for providing flashing of the light source 20, 21. Such circuitry means may take the form of a mercury switch (or like tilt switch), such as shown in U.S. Patent 3,893,247 (the disclosure of which is hereby incorporated by reference herein), or may comprise solid state circuitry means, such as shown in U.S. Patent 4,158,922 (the disclosure of which is hereby incorporated by reference herein). One desired form such circuitry means may take is illustrated schematically in FIGURE 6, wherein an integrated circuit chip 30 and capacitor 31 are operatively interconnected to the e.m.f. source 18, light sources 20, 21, and switch means 22. The integrated circuit chip 30 may be chip LM3909 manufactured by National Semi-Conductor. When the chip 30 is provided, the L.E.D.s 20, 21 periodically flash irrespective of the orientation of the shoe 10.

In order to provide for mounting of the electrical components which provide visibility for the shoe, according to the invention means are provided defining a cavity 33 in the integral sole and heel piece 14. The cavity 33 preferably is open topped, as illustrated in FIGURES 3 and 4, for ease of insertion and replacement of the components, and also preferably is located adjacent the heel portion 16 of the shoe 10. The cavity 33 is positioned and

dimensioned so as to be large enough to accommodate the necessary electrical components while minimizing interference with the functionality of the integral sole and heel piece 14 of the shoe 10.

5 For the embodiment illustrated in FIGURES 1, 3, and 4, the cavity 33 communicates with a pair of passageways 34, 35, and a channel 36. The channel 36 extends forwardly of the cavity 33 toward the toe portion 15 of the shoe, and is adapted to
10 contain electrical wires 37 operatively interconnecting the L.E.D. 21 to the e.m.f. source 18. The passageway 34 extends from cavity 33 to the rear of the integral sole and heel piece 14, and is adapted to mount the L.E.D. 20, and to contain wires
15 38 extending from the source of e.m.f. 18 to the L.E.D. 20. The passageway 35 extends from cavity 33 to one side of the integral sole and heel piece 14, adjacent the heel portion 16, for mounting the switch means 22, with wires (not shown) passing from
20 switch means 22 through the cavity 33 to other electrical components.

 Preferably the circuitry means is mounted on a single substrate, or in a single container, shown schematically by reference numeral 40 in
25 FIGURES 5 and 6, and the container 40 and source of e.m.f. 18 are appropriately electrically interconnected and encapsulated in an insert 42 (see FIGURE 5). The material forming the body of the insert 42, and encapsulating the components 18, 40,
30 preferably comprises a resilient material having cushioning characteristics comparable to the cushioning characteristics of the material forming the integral sole and heel piece 14 (e.g. foam and/or rubber), and has appropriate electrical wire
35 sets 43, 44 extending therefrom. The dimensions of

the insert 42 are preferably configured to be substantially the same as the dimensions of the cavity 33 so that an interference (but not a press) fit is provided between the insert 42 and the walls of the integral heel and sole piece 14 defining the cavity 33. In this way there is a minimum of disruption of the functional features of the shoe 10, while at the same time the components 18, 40 are properly protected.

The wires 43, 44 may have any desired conventional quick-connect couplings at the ends thereof, for operative connection to the L.E.D.s 20, 21, switch means 22, and the like. For instance the wires 44 may be connected up to the wire 38 leading to the rear L.E.D. 20, and likewise to wires for the switch means 22, while the wires 43 are operatively connected to the wires 37 leading to the front L.E.D. 21.

A conventional liner 46 of resilient material will usually be placed in the interior of the shoe 10, atop the integral sole and heel piece 14, as illustrated in FIGURE 3.

Means are provided for mounting the light source in the shoe 10 so that the light source is clearly visible from the exterior of the shoe. For the embodiment illustrated in FIGURES 1 through 3, two different mounting means are disclosed. For the rear L.E.D. 20, the mounting means comprise means defining a recess in the integral heel and sole piece 14, which recess communicates with the passageway 34, and which has dimensions corresponding to the exterior dimensions of the L.E.D. 20. In this way a tight interference fit is provided between the material forming the integral heel and sole piece 14 and the exterior of the

L.E.D. 20, to positively -- yet releasably -- hold the L.E.D. 20 in place.

5 For the toe L.E.D. 21, the mounting means comprise means defining a recess in the toe portion of the upper 12. In shoes wherein a section of resilient material covering the bottom of the integral sole and heel piece 14 extends upwardly to cover a portion of the toe, such a section being illustrated generally by reference numeral 48 in 10 FIGURES 2 and 3, the section 48 also will have means defining a recess therein for receipt of the L.E.D. 21. The upper 12 and section 48 thus provide a tight gripping action for the exterior of the L.E.D. 21, providing an interference fit tightly, but 15 releasably, holding the L.E.D. 21 in place. Suitable adhesive may be provided in addition to the recesses in the shoe components described above for holding the light sources 20, 21 in place with respect to the shoe 10.

20 If desired in order to minimize the number of component parts, the light source and switch means may be integrated into a single component. Illustrated schematically in FIGURE 8 is a conventional electrical component 50 which comprises 25 a combined light source and switch. The combined switch actuator and lens 51 is transparent, and a light bulb (not shown) is mounted in the interior of collar 52, and the light bulb is electrically interconnected to switch base 53. The entire 30 structure 50 may be mounted in the rear section 16 of the shoe 10, in place of the L.E.D. 20, if desired, with the switch button 51 extending exteriorly of the shoe 10. A typical conventional integral switch and light source may be model MPN- 35 206 sold under the trademark "Alcoswitch".

Construction And Operation

The construction of the sport shoe 10 according to the present invention is simple. Preferably during the manufacture of the shoe the cavity 33, and passageways 34, 35 and channel 36 (where necessary) are molded in the integral sole and heel piece 14 (although it is also possible to cut such cavity, passageways, and the like in the integral sole and heel piece 14 by hand after construction of the shoe). The batteries 18, circuitry means 30, 31 contained in container 40, and electrical wires 43, 44, are appropriately interconnected, and then encapsulated in resilient material to provide the insert 42.

An individual assembling the shoe 10 inserts the L.E.D.s 20, 21 in the recesses provided therefor in the heel section 16 and toe 15, respectively, of the shoe 10. Then wires 37, 38 are respectively interconnected to wires 43, 44 extending from insert 42, and insert 42 is pressed into cavity 33, being held in place by inter-engagement between the exterior walls of insert 42 and the walls defining the cavity 33. Where the switch means 22 along the side of the integral sole and heel piece 14 is provided (see FIGURES 1 and 4), the switch actuator is passed through passageway 35 so that it is accessible from the exterior of the shoe, and the wires therefrom are interconnected to the wires 44 before the insert 42 is pressed into the cavity 33.

Where the pressure activated switch 24 is utilized in addition to, or in place of, the switch means 22, it is appropriately electrically interconnected to the wires 43 or 44, and then

placed on top of the insert 42 so that it is even with the portion of integral sole and heel 14 defining the interior of the shoe 10. The conventional insert 46 is then placed in the shoe 10
5 on top of the integral sole and heel 14.

When the wearer will be running with the shoes 10 at night, or at other times when the visibility is poor, the wearer merely activates the switch 22 which causes (for the embodiment
10 illustrated in FIGURE 6) periodic flashing of the L.E.D.s 20, 21. Because of the positioning of the L.E.D.s 20, 21, and the utilization thereof on the wearer's feet, the wearer will have maximum
15 visibility to motor vehicles which may be travelling along the routes traversed by the wearer, thus minimizing the possibility that the wearer will be
inadvertently struck by a vehicle.

When the shoes 10 are not in use, or to be used when visibility is good, the switch means 22
20 are activated so that the light sources 20, 21 are not operatively connected to the e.m.f. source 18.

Thus it will be seen that according to the present invention a sport shoe providing maximum
25 visibility for the wearer, while providing minimum interference with the functionality of the shoe, has been provided. While the invention has been herein shown and described in what is presently conceived to be the most practical and preferred embodiment
30 thereof, it will be apparent to those of ordinary skill in the art that many modifications may be made thereof within the scope of the invention, which scope is to be accorded the broadest interpretation of the appended claims so as to encompass all equivalent structures and devices.

CLAIMS:

1. A shoe comprising; an upper; a source of e.m.f.; a light source adapted to be connected up to said source of e.m.f.; circuitry means for
5 providing flashing of said light source; and switch means for selectively connecting and disconnecting said light source, through said circuitry means, to and from said source of e.m.f.; characterized by:
an integral sole and heel piece of
10 resilient material; means defining a cavity in said integral sole and heel piece for receipt of said source of e.m.f. and said circuitry means; and means for mounting said light source to said shoe so that said light source is clearly visible from the
15 exterior of said shoe.

2. A sport shoe as recited in claim 1 further characterized in that said shoe includes a heel portion and a toe portion, and wherein said
means for mounting said light source comprises means
20 for mounting said light source in said integral sole and heel piece at said heel portion of said shoe.

3. A sport shoe as recited in claim 2 further characterized by a second light source, and means for mounting said second light source to said
25 upper at said toe portion of said shoe.

4. A sport shoe as recited in claim 2 further characterized in that said means defining said cavity defines said cavity adjacent said heel portion of said shoe, and further characterized by a

passageway formed in said integral sole and heel piece interconnecting said cavity and said light source.

5 4 further characterized in that said source of e.m.f. and said circuitry means are encapsulated in resilient material, with electrical wires extending outwardly from said encapsulating resilient material, to define an insert; and said insert has
10 substantially the same dimensions as said cavity, said insert having an interference fit with said means defining said cavity.

6: A sport shoe as recited in claim 4 further characterized in that said switch means
15 includes a switch actuator; means for mounting said switch actuator so that it extends outwardly from a side portion of said shoe, adjacent said heel portion thereof; and means defining a passageway in
20 said integral sole and heel piece extending from said switch actuator to said cavity.

7. A sport shoe as recited in claim 1 further characterized in that said switch means comprises a pressure activated switch, said pressure activated switch being received within said cavity.

25 8. A sport shoe as recited in claim 1 further characterized in that said circuitry means comprises an integrated circuit chip and capacitor.

9. A sport shoe as recited in claim 1 further characterized in that said light source and
30 said switch means comprise a single structure, a

switch actuator forming a lens for said light source; and said means for mounting said light source comprises means for mounting said single structure in said integral sole and heel piece so
5 that said lens extends exteriorly of the rear of said shoe.

10. A sport shoe as recited in claim 1 wherein said light source comprises first and second L.E.D.s.

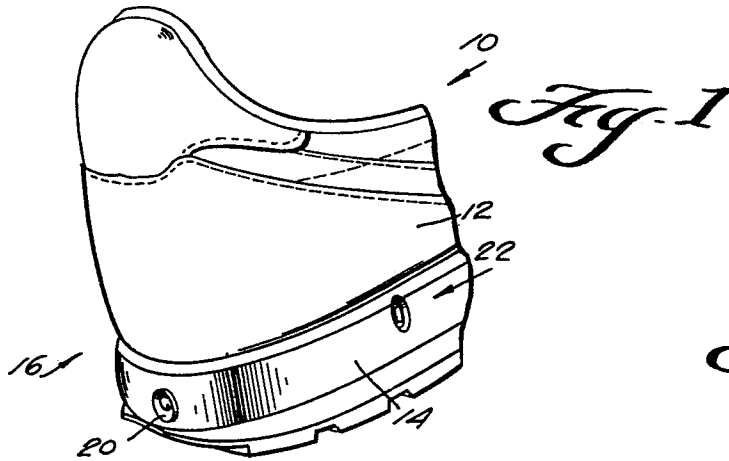

Fig. 2

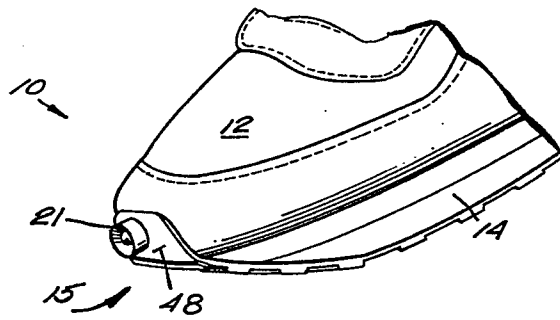

Fig. 3

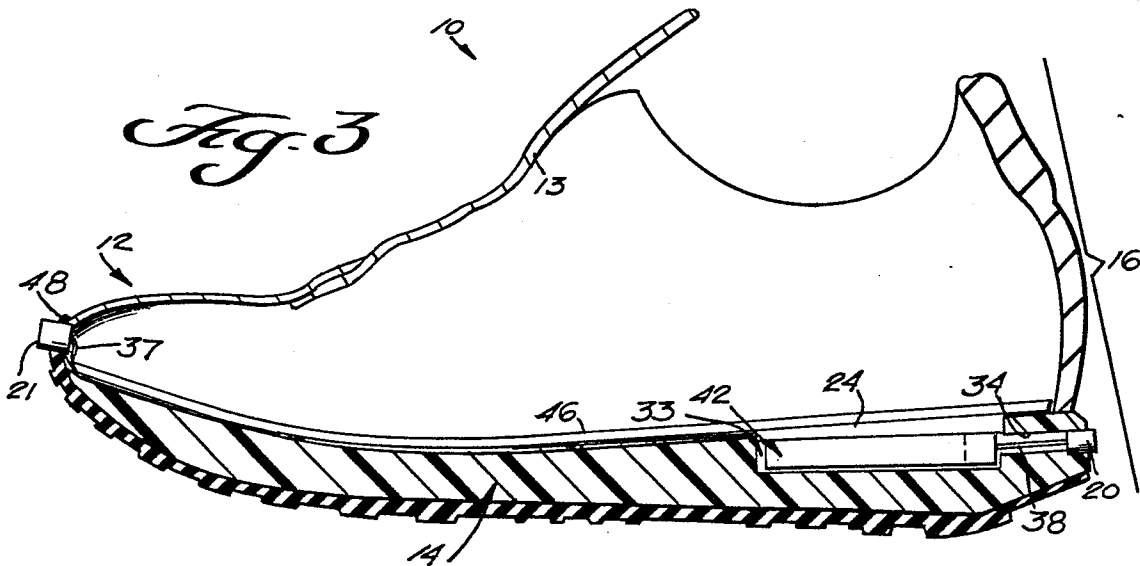

Fig. 1

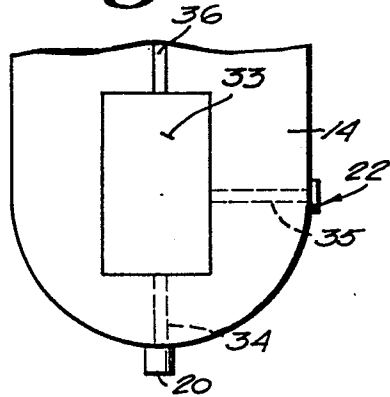

Fig. 5

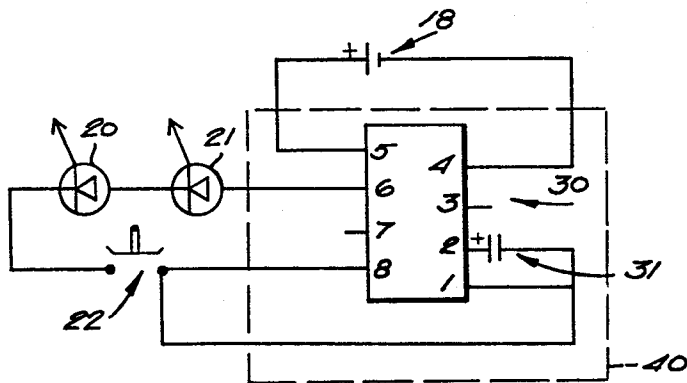
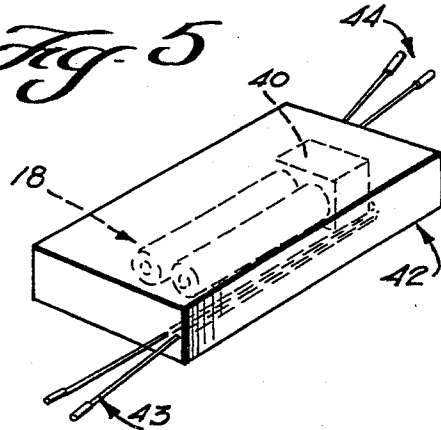

Fig. 6

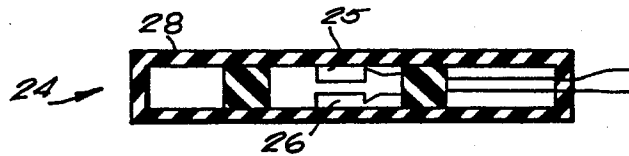

Fig. 7

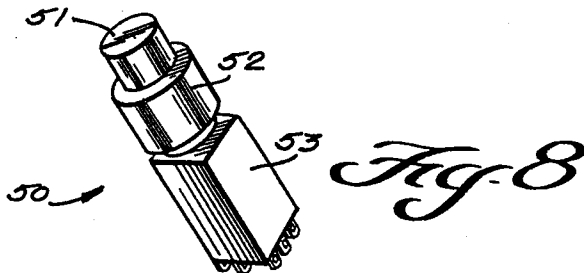

Fig. 8



DOCUMENTS CONSIDERED TO BE RELEVANT			
Category	Citation of document with indication, where appropriate, of relevant passages	Relevant to claim	CLASSIFICATION OF THE APPLICATION (Int. Cl. ³)
A	US-A-4 020 572 (G. CHIARAMONTE, Jr.) * Abstract; figures 1-4 *	1,2,4- 6,8,9	A 43 B 3/00
A	--- US-A-4 233 760 (J.E. HAYNES) * Abstract; figures 1-3 *	1	
D,A	--- US-A-4 158 922 (A. DANA, III) * Abstract; figures 1,2 *	1,3,8	
D,A	--- US-A-3 893 247 (A. DANA, III) * Abstract; figures 1-5 *	1-3,5 6	
A	--- NL-A-8 005 050 (J.P.M. DE NIJS et al.) * Page 2, lines 10-29; figures 1-4 *	1,3,7 8,10	
			TECHNICAL FIELDS SEARCHED (Int. Cl. ³)
			A 43 B
The present search report has been drawn up for all claims			
Place of search THE HAGUE		Date of completion of the search 29-06-1984	Examiner MALIC K.
CATEGORY OF CITED DOCUMENTS			
X : particularly relevant if taken alone		T : theory or principle underlying the invention	
Y : particularly relevant if combined with another document of the same category		E : earlier patent document, but published on, or after the filing date	
A : technological background		D : document cited in the application	
O : non-written disclosure		L : document cited for other reasons	
P : intermediate document		& : member of the same patent family, corresponding document	