



US00D343385S

# United States Patent [19]

[11] Patent Number: **Des. 343,385**

Sachs

[45] Date of Patent: **\*\* Jan. 18, 1994**

[54] **ELECTRICAL GROUND CLIP**

4,186,981 2/1980 Holton ..... 439/92

[76] Inventor: **Isaac Sachs**, 283 Newton,  
Dollard-des-Ormeaux, Quebec,  
Canada, H9A 3G1

*Primary Examiner*—Wallace R. Burke  
*Assistant Examiner*—Joel Sincavage  
*Attorney, Agent, or Firm*—Longacre & White

[\*] Notice: The portion of the term of this patent  
subsequent to Oct. 12, 2007 has been  
disclaimed.

### [57] CLAIM

The ornamental design for an electrical ground clip, as  
shown and described.

[\*\*] Term: **14 Years**

### DESCRIPTION

[21] Appl. No.: **924,870**

[22] Filed: **Aug. 5, 1992**

#### Related U.S. Application Data

[63] Continuation-in-part of Ser. No. 837,427, Feb. 20, 1992.

[52] U.S. Cl. .... **D13/154**

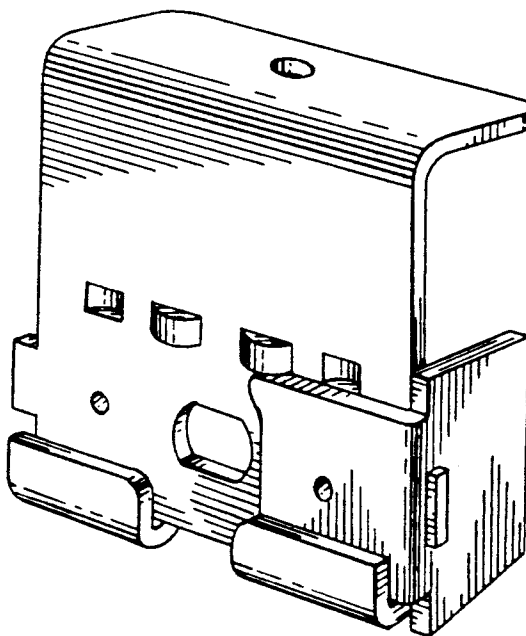
[58] Field of Search ..... D8/356; 174/6, 35 GC,  
174/40 CC, 51; 439/92, 95, 108, 110; D13/133,  
154

FIG. 1 is a right side, top and front perspective view of  
an electrical ground clip showing my new design;  
FIG. 2 is a front elevational view thereof;  
FIG. 3 is a left side elevational view thereof;  
FIG. 4 is a right side elevational view thereof;  
FIG. 5 is a rear elevational view thereof;  
FIG. 6 is a top plan view thereof;  
FIG. 7 is a bottom plan view thereof;  
FIG. 8 is a left side, top and front perspective view of an  
electrical ground clip showing a second embodiment of  
my new design;  
FIG. 9 is a front elevational view thereof;  
FIG. 10 is a left side elevational view thereof;  
FIG. 11 is a right side elevational view thereof;  
FIG. 12 is a rear elevational view thereof;  
FIG. 13 is a top plan view thereof; and,  
FIG. 14 is a bottom plan view thereof.

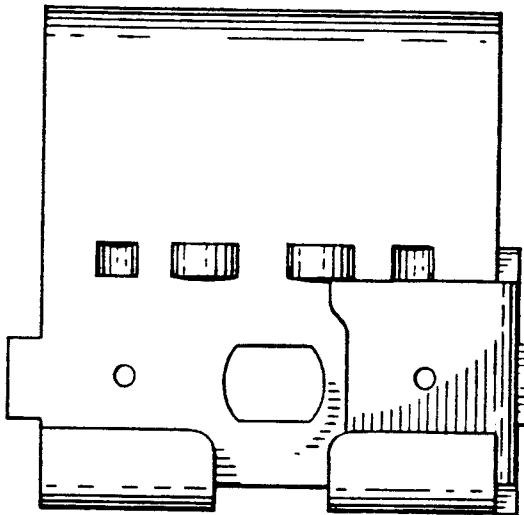
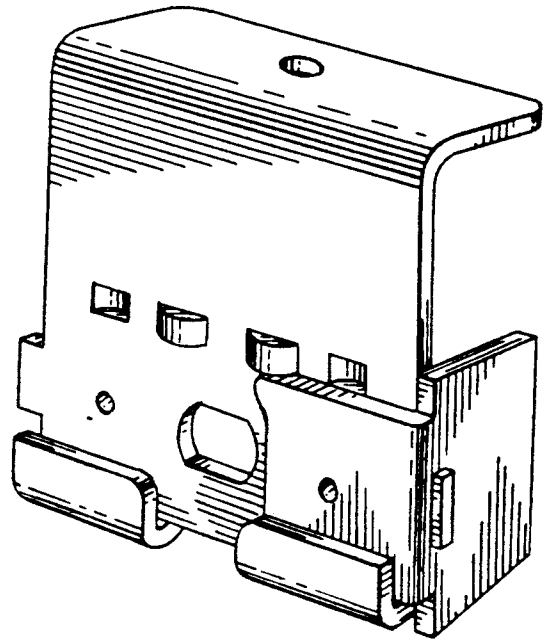
#### [56] References Cited

##### U.S. PATENT DOCUMENTS

D. 297,410	8/1988	Sachs	.....	D8/356
2,911,608	11/1959	Lee	.....	174/35 GC
3,029,405	4/1962	Buchanan	.....	439/95
3,919,457	11/1975	Steiner	.....	439/110 X

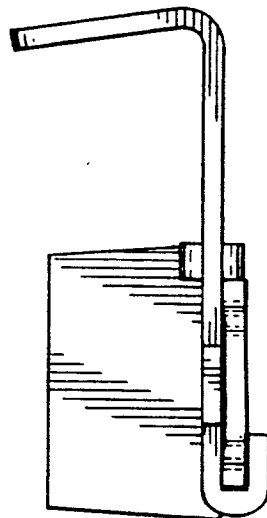


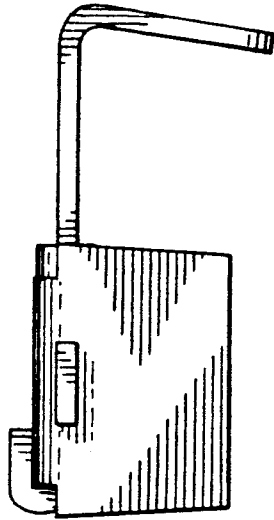
*Fig. 1*



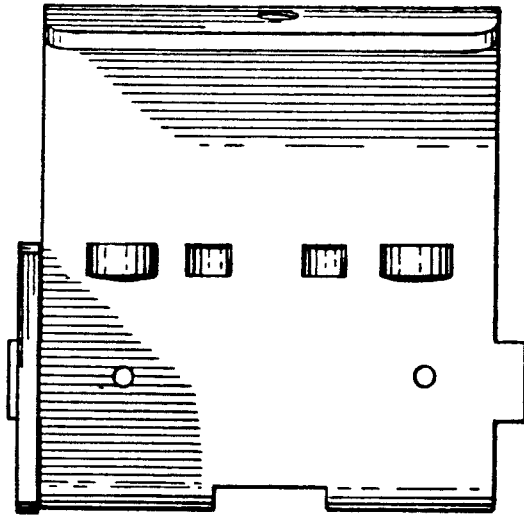
*Fig. 2*

*Fig. 3*

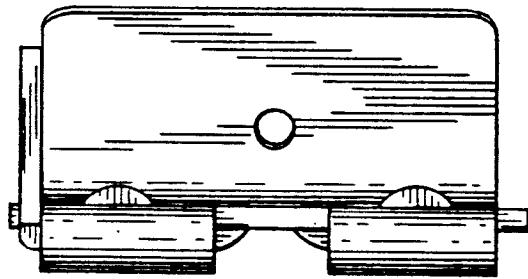




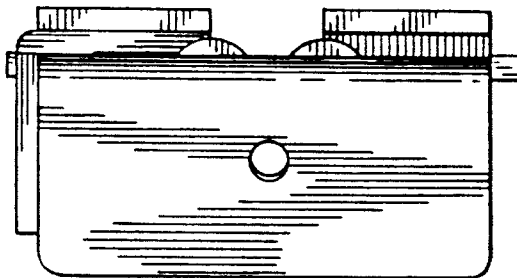
*Fig. 4*



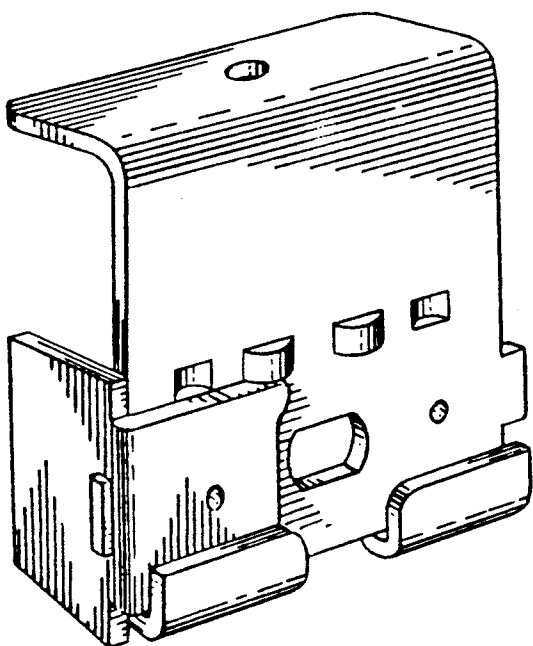
*Fig. 5*



*Fig. 7*

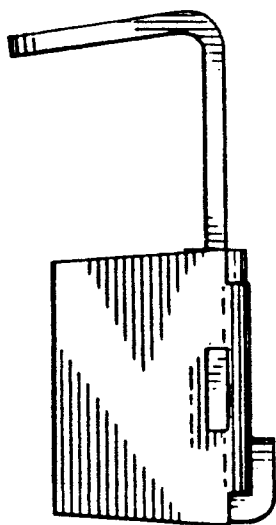
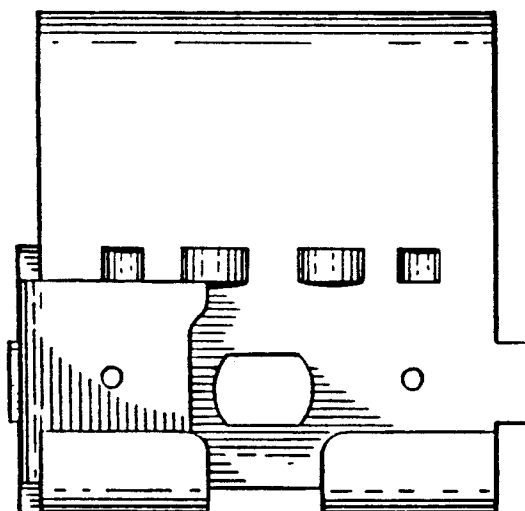


*Fig. 6*

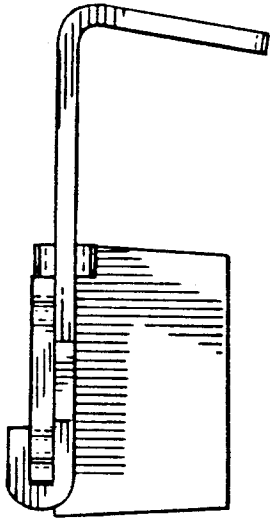


*Fig. 8*

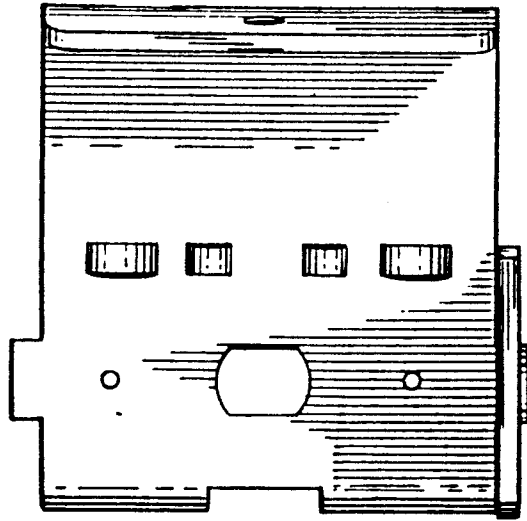
*Fig. 9*



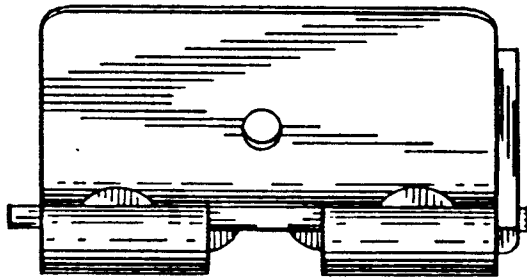
*Fig. 10*



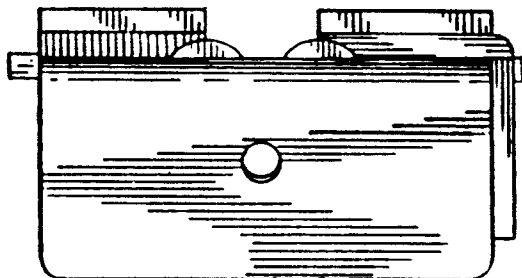
*Fig. 11*



*Fig. 12*



*Fig. 14*



*Fig. 13*