



US00D592004S

(12) **United States Design Patent**  
**Loving**

(10) **Patent No.:** **US D592,004 S**

(45) **Date of Patent:** **\*\* May 12, 2009**

(54) **BARBECUE GRILL**

D481,255 S \* 10/2003 Mak ..... D7/332  
D497,078 S \* 10/2004 Ethridge ..... D7/402

(76) Inventor: **Christopher B. Loving**, 115 Bonami Ct., Fairburn, GA (US) 30213

\* cited by examiner

(\*\*) Term: **14 Years**

*Primary Examiner*—Ruth McInroy

(74) *Attorney, Agent, or Firm*—Jerome J. Norris

(21) Appl. No.: **29/222,658**

(57) **CLAIM**

(22) Filed: **Feb. 3, 2005**

The ornamental design for barbecue grill, as shown and described.

(51) **LOC (9) Cl.** ..... **07-02**

(52) **U.S. Cl.** ..... **D7/337**

(58) **Field of Classification Search** ..... D7/332,  
D7/334–337, 402–405; 126/25 R, 25 A,  
126/25 AA, 25 B, 29–30, 41 R, 38, 37 R,  
126/9 R, 40, 50, 304 R, 305, 276; 99/419,  
99/421 R, 444, 450; 312/140.1, 140.3, 236;  
248/129; 108/44, 519

See application file for complete search history.

**DESCRIPTION**

FIG. 1 is a front perspective view of a barbecue grill showing my new design;

FIG. 2 is a side elevational view thereof; the opposite side being a mirror image;

FIG. 3 is a rear elevational view thereof;

FIG. 4 is a side elevational view thereof with cap raised; the opposite side being a mirror image;

FIG. 5 is an exploded side perspective view thereof, the opposite side being a mirror image;

FIG. 6 is a reduced perspective view showing the grill in tow behind a vehicle, the broken lines form no part of the claimed design; and,

FIG. 7 shows the grill with the support disc removed and mounted on an alternate support, the support shown in broken lines forms no part of the claimed design.

(56)

**References Cited**

**U.S. PATENT DOCUMENTS**

D270,606 S *	9/1983	McCrary et al. ....	D7/334
D312,746 S *	12/1990	Lutter ..... ..	D7/337
D324,153 S *	2/1992	Wood ..... ..	D7/402
D325,319 S *	4/1992	Zilber et al. ....	D7/337
D326,583 S *	6/1992	Lutter et al. ....	D7/332
D358,527 S *	5/1995	Danielson et al. ....	D7/332
D373,047 S *	8/1996	McCrary et al. ....	D7/334
D379,286 S *	5/1997	Fincher ..... ..	D7/334
D397,580 S *	9/1998	Dunn et al. ....	D7/402
D467,119 S *	12/2002	McGargill ..... ..	D7/332

**1 Claim, 4 Drawing Sheets**

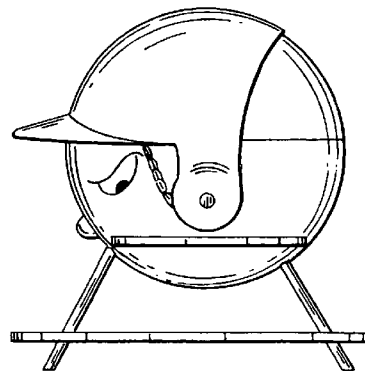
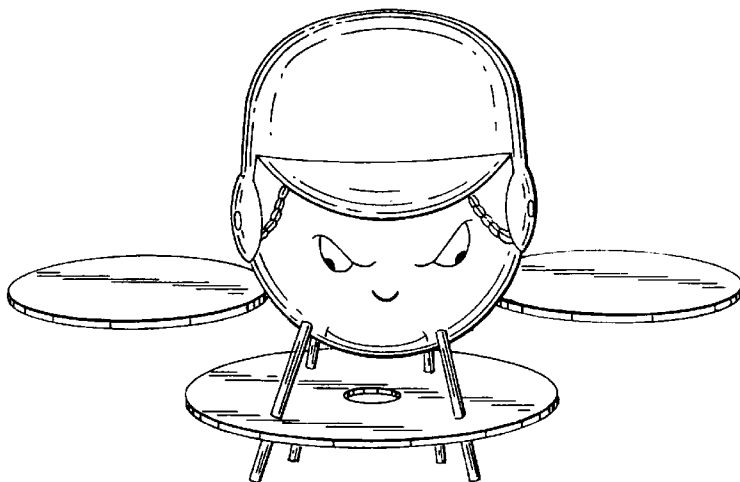

FIG. 1

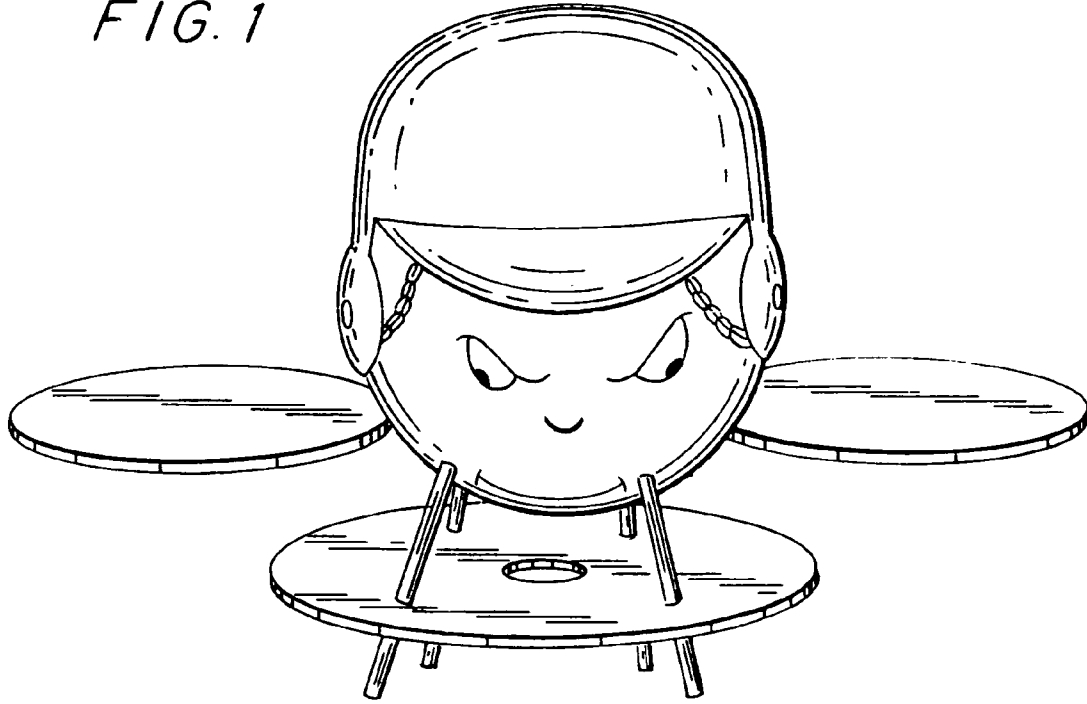

FIG. 2

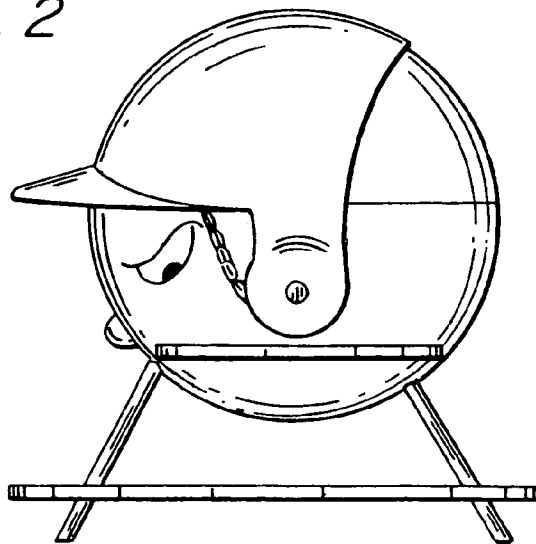

FIG. 3

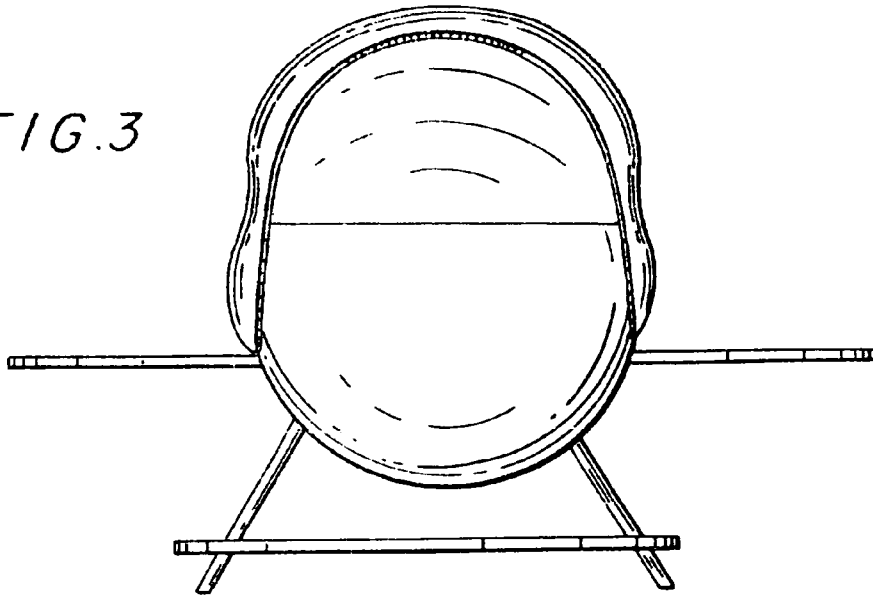

FIG. 4

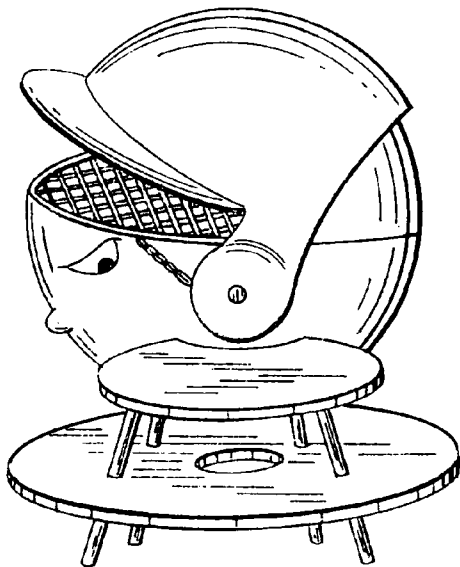
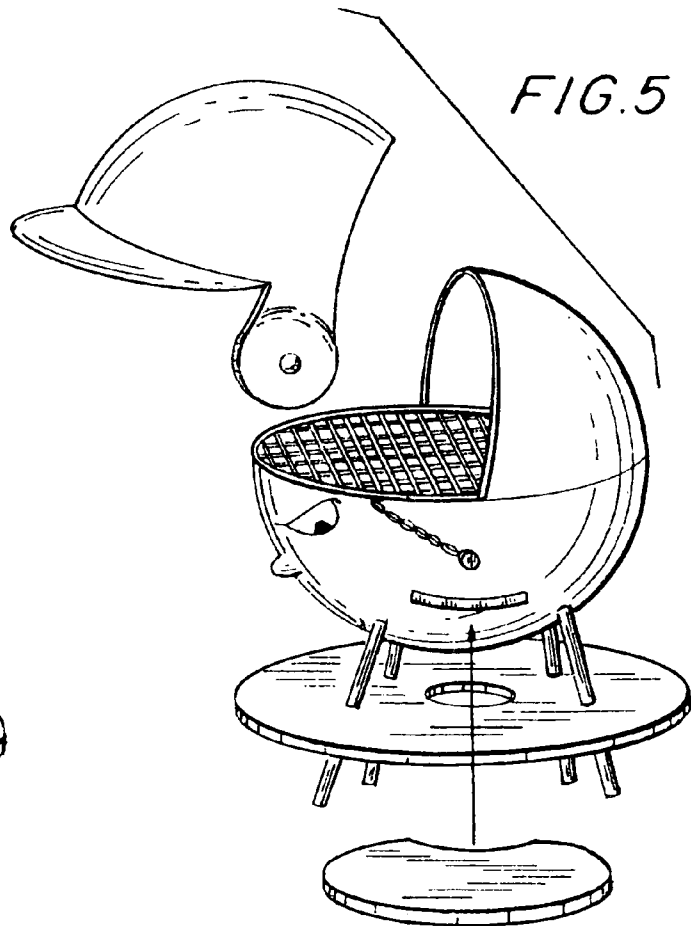

FIG. 5



*FIG. 6*

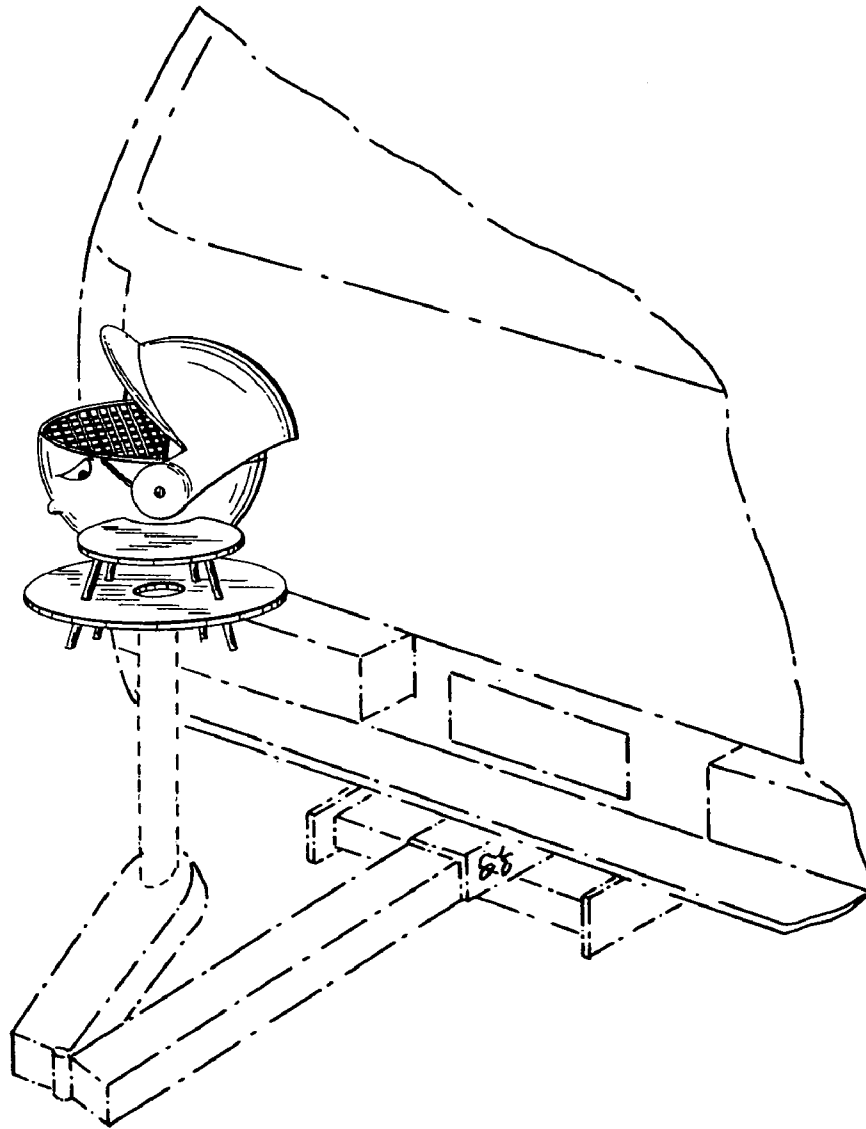

FIG. 7

