



US00D803003S

(12) **United States Design Patent** (10) **Patent No.:** **US D803,003 S**
Marck et al. (45) **Date of Patent:** **** Nov. 21, 2017**

(54) **DINNERWARE**

D737,634 S * 9/2015 Brown D7/396.6
D742,585 S * 11/2015 Bennett D27/136
D756,715 S * 5/2016 Ricciardi D7/587

(71) Applicant: **G. G. Marck & Associates, Inc.**,
Toledo, OH (US)

(72) Inventors: **Gary G. Marck**, Holland, OH (US);
Mouin B. Elkhatib, Toledo, OH (US)

(73) Assignee: **G. G. Marck & Associates, Inc.**,
Toledo, OH (US)

(**) Term: **15 Years**

(21) Appl. No.: **29/550,914**

(22) Filed: **Jan. 8, 2016**

(51) **LOC (10) Cl.** **07-01**

(52) **U.S. Cl.**
USPC **D7/565**

(58) **Field of Classification Search**
USPC D7/500, 587, 565, 560
CPC A47G 19/025; A47G 19/02
See application file for complete search history.

(56) **References Cited**

U.S. PATENT DOCUMENTS

D95,867 S * 6/1935 Sebring D7/584
D450,220 S * 11/2001 Walz D7/545
D478,473 S * 8/2003 Zettle D7/545
D564,877 S * 3/2008 Hood D9/454
D660,651 S * 5/2012 Peters D7/587
D693,647 S * 11/2013 Seyers D7/587
D702,089 S * 4/2014 Seyers D7/587
D711,191 S * 8/2014 Lee D7/388

OTHER PUBLICATIONS

Stockyard Plate: [https://foodservice.libbey.com/Product-Repository/Plates7/\(language\)/eng-US](https://foodservice.libbey.com/Product-Repository/Plates7/(language)/eng-US).

* cited by examiner

Primary Examiner — Cynthia Underwood
(74) *Attorney, Agent, or Firm* — Michael E. Dockins;
Shumaker, Loop & Kendrick, LLP

(57) **CLAIM**

The ornamental design for dinnerware, as shown and described.

DESCRIPTION

FIG. 1 is a perspective view of dinnerware according to an embodiment of the invention;
FIG. 2 is a top plan view thereof;
FIG. 3 is a bottom plan view thereof;
FIG. 4 is a front elevational view thereof, with all sides being identical;
FIG. 5 is a perspective view of dinnerware according to a second embodiment of the invention;
FIG. 6 is a top plan view thereof;
FIG. 7 is a bottom plan view thereof; and,
FIG. 8 is a front devotional view thereof, with all sides being identical.
The broken lines represent environment and form no part of the claim.

1 Claim, 6 Drawing Sheets

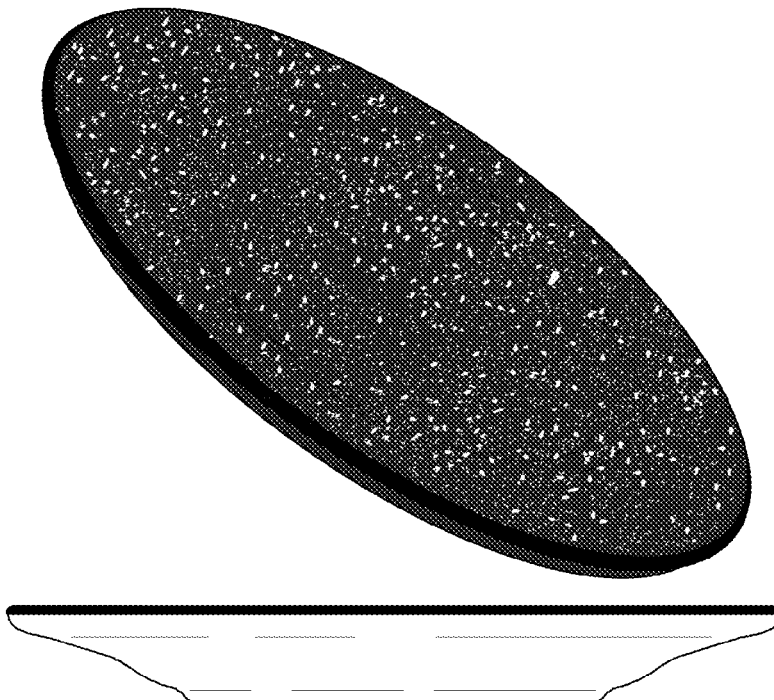

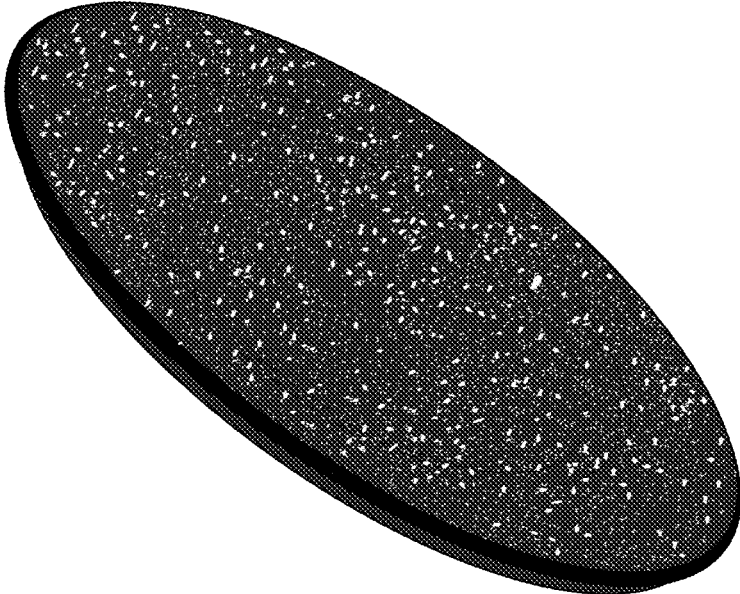

FIG. 1

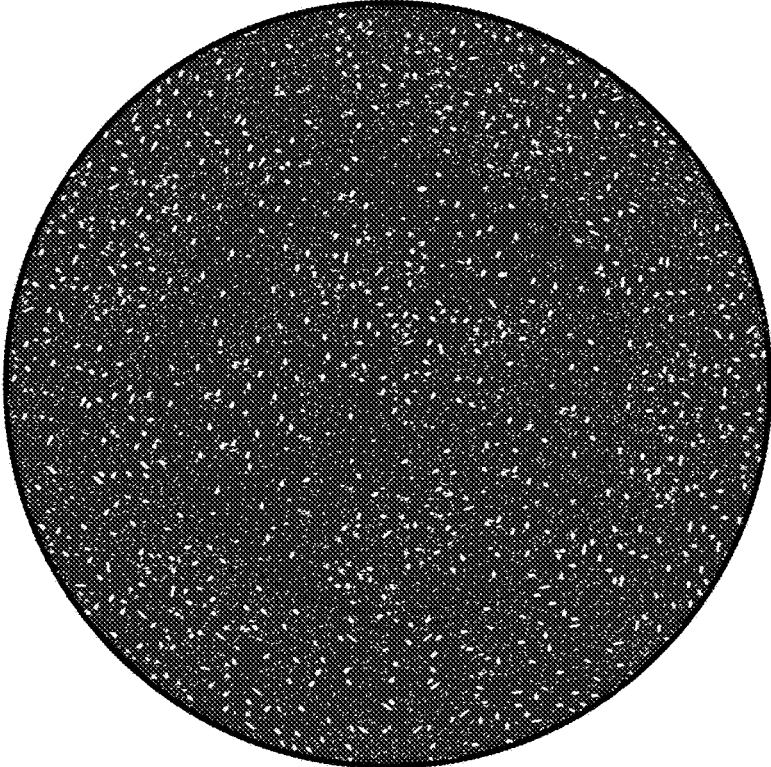

FIG. 2

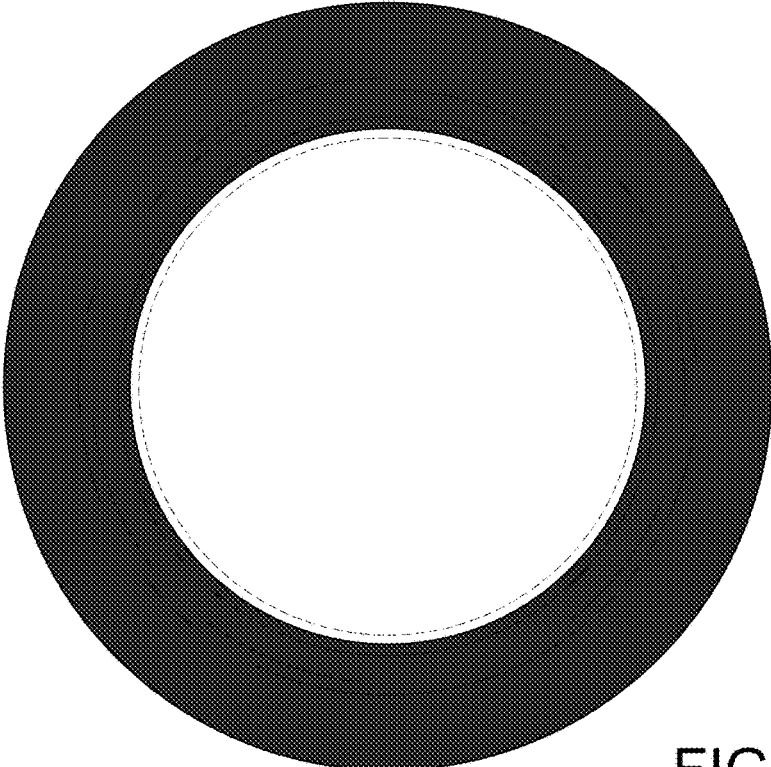

FIG. 3



FIG. 4

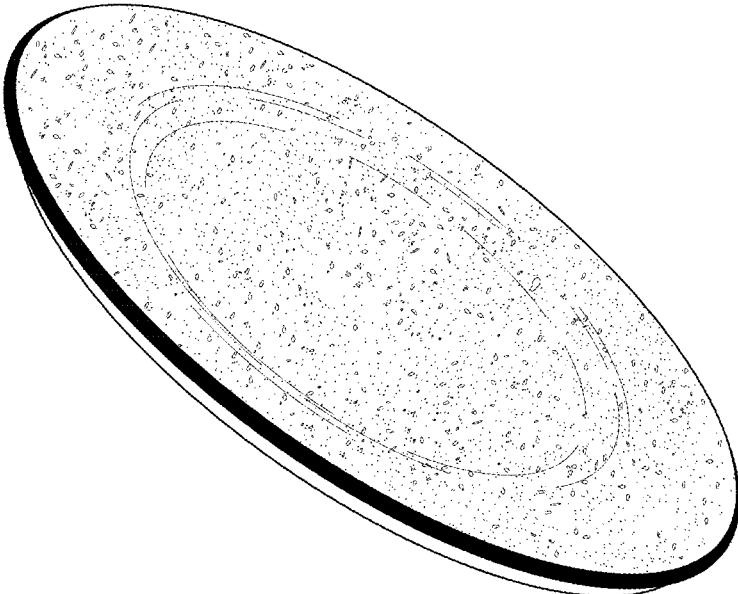

FIG. 5

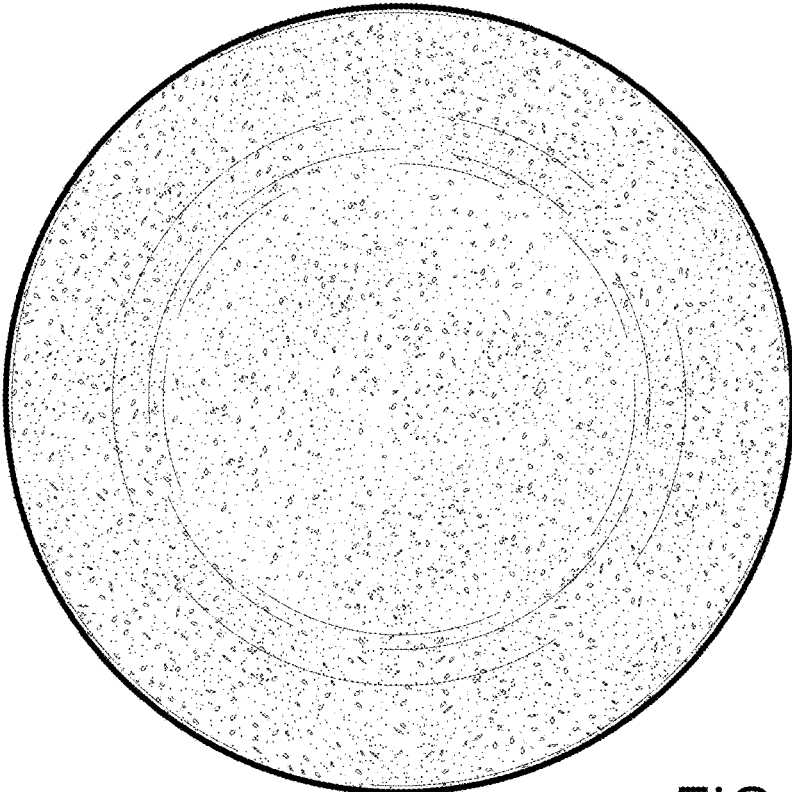

FIG. 6

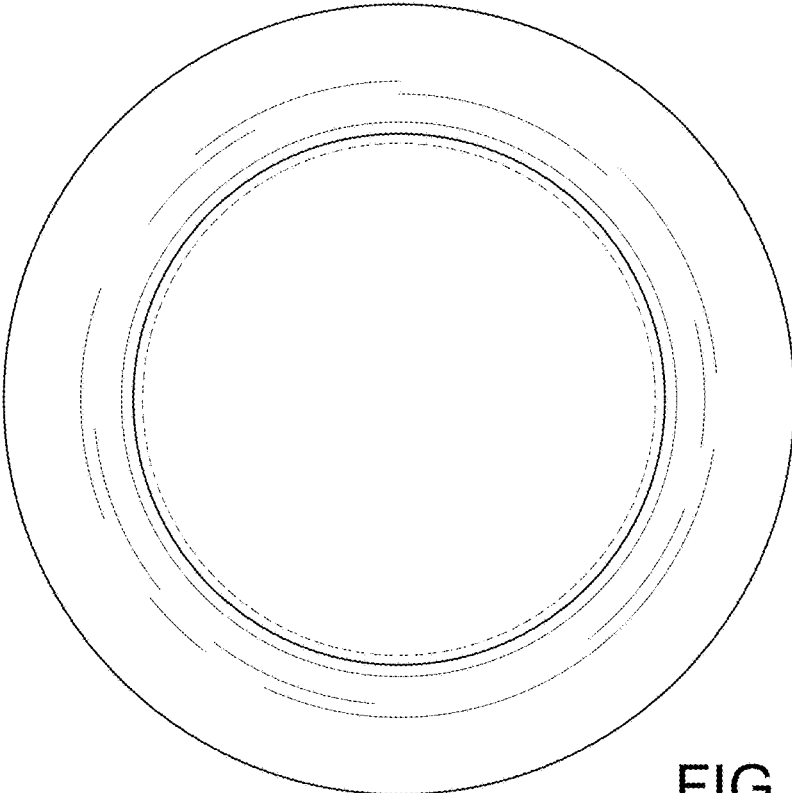

FIG. 7



FIG. 8