



US00D901441S

(12) **United States Design Patent** (10) **Patent No.:** **US D901,441 S**  
**Huang et al.** (45) **Date of Patent:** **\*\* Nov. 10, 2020**

(54) **SPEAKER BOX**  
(71) Applicant: **BEIJING XIAOMI MOBILE SOFTWARE CO., LTD.**, Beijing (CN)  
(72) Inventors: **Siyu Huang**, Beijing (CN); **Hao Jiang**, Beijing (CN)  
(73) Assignee: **BEIJING XIAOMI MOBILE SOFTWARE CO., LTD.**, Beijing (CN)  
(\*\*) Term: **15 Years**

D576,486 S \* 9/2008 Koza ..... D9/432  
D618,232 S \* 6/2010 O'Neil ..... D14/314  
D646,665 S \* 10/2011 Iijima ..... D14/214  
D647,866 S \* 11/2011 Chen ..... D14/125  
D650,377 S \* 12/2011 Akana ..... D14/314  
D692,849 S \* 11/2013 Choi ..... D14/188  
D695,711 S \* 12/2013 Szymanski ..... D14/214  
D707,202 S \* 6/2014 McManigal ..... D14/214  
(Continued)

(21) Appl. No.: **35/505,786**  
(22) Filed: **May 17, 2018**

FOREIGN PATENT DOCUMENTS

KR 301000377.0000 \* 3/2019  
WO D102963-001 \* 2/2018

(80) **Hague Agreement Data**  
Int. Filing Date: **May 17, 2018**  
Int. Reg. No.: **DM/102963**  
Int. Reg. Date: **May 17, 2018**  
Int. Reg. Pub. Date: **Oct. 5, 2018**

OTHER PUBLICATIONS

Xiaomi Mi AI Speaker Mini Review, announced Mar. 29, 2018 [online], [retrieved Jul. 16, 2019]. Available from Internet, URL: <<https://www.youtube.com/watch?v=iy6NhiNbLPs>> (Year: 2018).\*  
(Continued)

(30) **Foreign Application Priority Data**  
Nov. 17, 2017 (CN) ..... 2017 3 0570085

*Primary Examiner* — Dana K Weiland  
(74) *Attorney, Agent, or Firm* — Dickinson Wright PLLC

(51) **LOC (12) Cl.** ..... **14-01**  
(52) **U.S. Cl.** ..... **D14/214**  
USPC ..... **D14/214**

(57) **CLAIM**  
The ornamental design for a speaker box, as shown and described.

(58) **Field of Classification Search**  
USPC ..... D14/204, 205, 206, 210–216, 221, 239, D14/249, 265, 209.1, 203.8, 253, 447, D14/192, 223, 224, 199, 372, 225, 226; D21/513, 516; D26/93; D29/112  
CPC . B60R 11/0217; B60R 11/0223; H04R 1/023; H04R 1/025; H04R 1/323; H04R 5/02; H04R 19/02; H04R 2400/00; H04R 2400/07; H04R 2400/11; G06F 1/16  
See application file for complete search history.

**DESCRIPTION**

**1.1** is a front elevation view of a speaker box showing our new design;  
**1.2** is a back elevation view thereof;  
**1.3** is a left side elevation view thereof;  
**1.4** is a right side elevation view thereof;  
**1.5** is a top plan view thereof;  
**1.6** is a bottom plan view thereof; and,  
**1.7** is a perspective view thereof.  
The broken lines shown in the drawings depict portions of the speaker box that form no part of the claimed design.

(56) **References Cited**  
U.S. PATENT DOCUMENTS

D526,640 S \* 8/2006 Chin ..... D14/188  
D576,053 S \* 9/2008 Lulic ..... D10/24

**1 Claim, 7 Drawing Sheets**

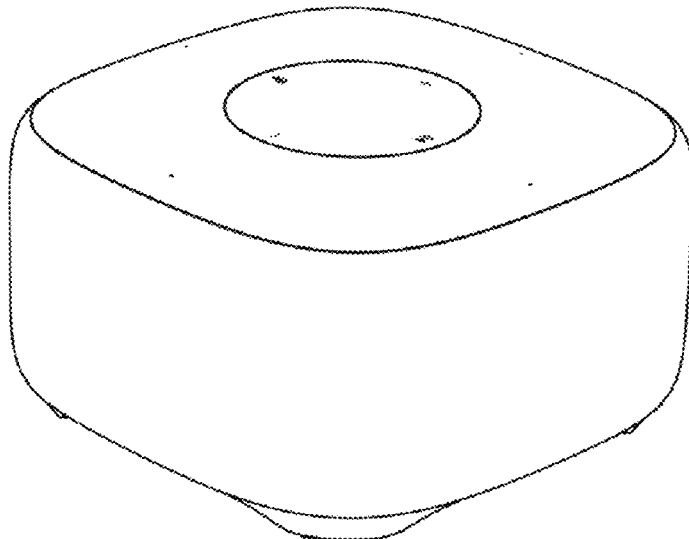

(56)

**References Cited**

## U.S. PATENT DOCUMENTS

D714,249 S \* 9/2014 Carney ..... D14/140  
 D718,739 S \* 12/2014 DiTullo ..... D14/214  
 D724,563 S \* 3/2015 Kim ..... D14/214  
 D725,624 S \* 3/2015 Carney ..... D14/140  
 D726,682 S \* 4/2015 Kim ..... D14/170  
 D736,186 S \* 8/2015 Kauppila ..... D14/225  
 D740,262 S \* 10/2015 Hasegawa ..... D14/240  
 D754,109 S \* 4/2016 Kelly ..... D14/240  
 D758,345 S \* 6/2016 Fujioka ..... D14/214  
 D768,607 S \* 10/2016 Altonen ..... D14/240  
 D771,593 S \* 11/2016 Koo ..... D14/214  
 D782,429 S \* 3/2017 Xianda ..... D14/125  
 D786,218 S \* 5/2017 Tan ..... D14/215  
 D799,588 S \* 10/2017 Nanno ..... D18/19  
 D800,697 S \* 10/2017 Fischer ..... D14/214  
 D813,192 S \* 3/2018 Zeng ..... D14/204  
 D824,349 S \* 7/2018 Kim ..... D14/125  
 D826,206 S \* 8/2018 Elmieh ..... D14/204

D830,343 S \* 10/2018 Fustino ..... D14/214  
 D835,068 S \* 12/2018 Chen ..... D14/214  
 D836,610 S \* 12/2018 Yoon ..... D14/216  
 D842,265 S \* 3/2019 Becker ..... D14/204  
 D844,587 S \* 4/2019 Lu ..... D14/214  
 D851,621 S \* 6/2019 Demin ..... D14/204  
 D859,415 S \* 9/2019 Liao ..... D14/434  
 D865,716 S \* 11/2019 Kuang ..... D14/216

## OTHER PUBLICATIONS

Xiaomi Mi AI Mini Speaker, announced Mar. 30, 2018 [online], [retrieved Jul. 16, 2019]. Available from Internet, URL: <[https://www.gearbest.com/speakers/pp\\_1699226.html](https://www.gearbest.com/speakers/pp_1699226.html)> (Year: 2018).\*

Philips Hue White LED Smart Light Bulb Starter Kit, announced Jul. 1, 2019 [online], [retrieved Jul. 16, 2019]. Available from Internet, URL: <[https://www.amazon.com/Philips-Hue-Starter-HomeKit-Assistant/dp/B07QZHMM4P?ref\\_=Oct\\_DLandingS\\_PC\\_29b0a6ff\\_5&smid=ATVPDKIKX0DER&pldnSite=1](https://www.amazon.com/Philips-Hue-Starter-HomeKit-Assistant/dp/B07QZHMM4P?ref_=Oct_DLandingS_PC_29b0a6ff_5&smid=ATVPDKIKX0DER&pldnSite=1)> (Year: 2019).\*

\* cited by examiner

1.1

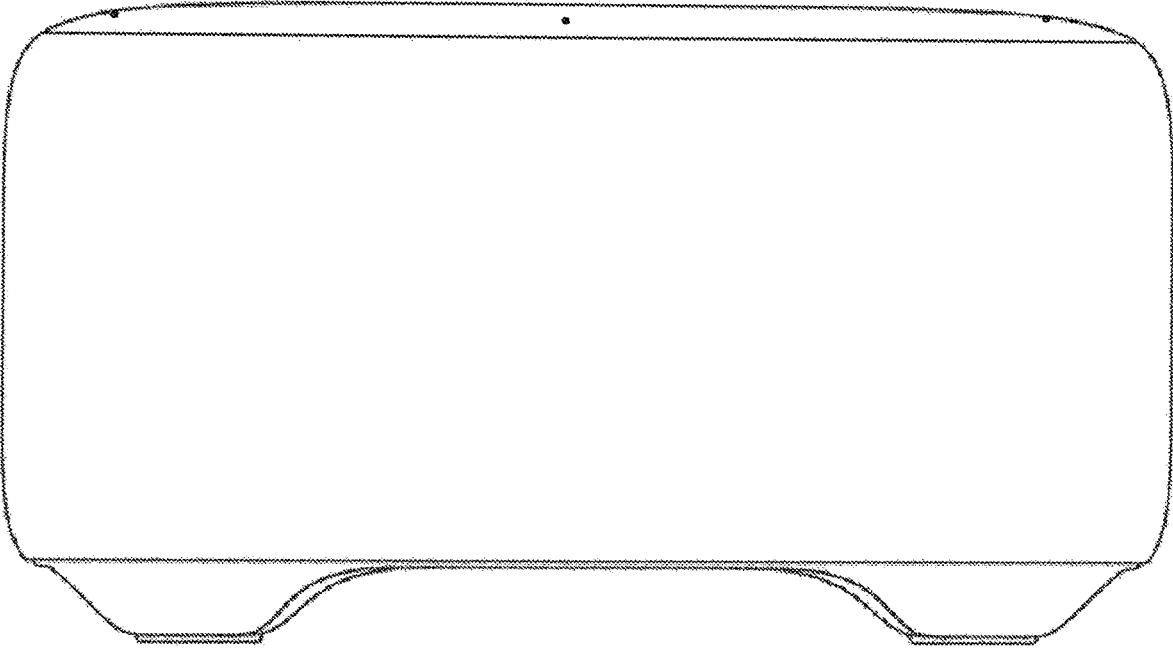

1.2

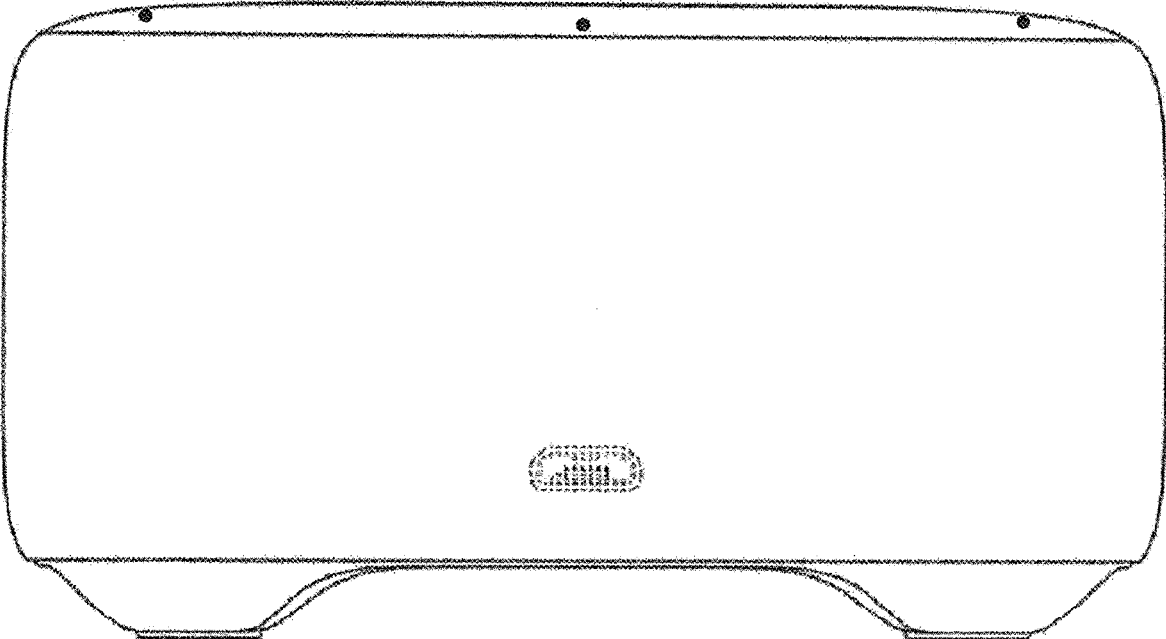

1.3

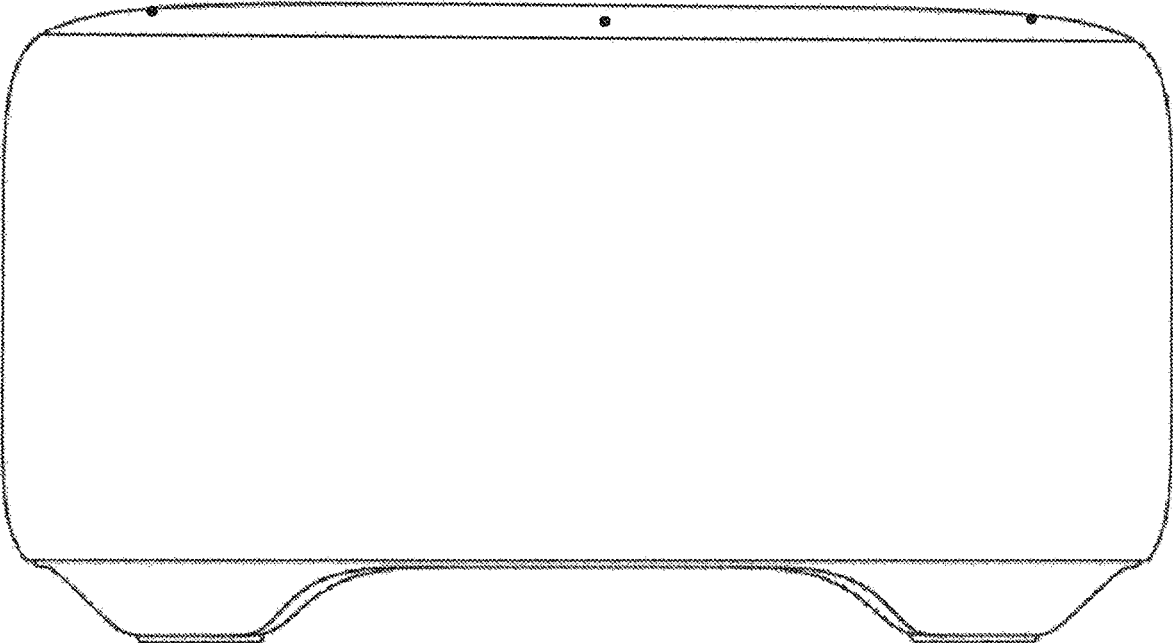

1.4

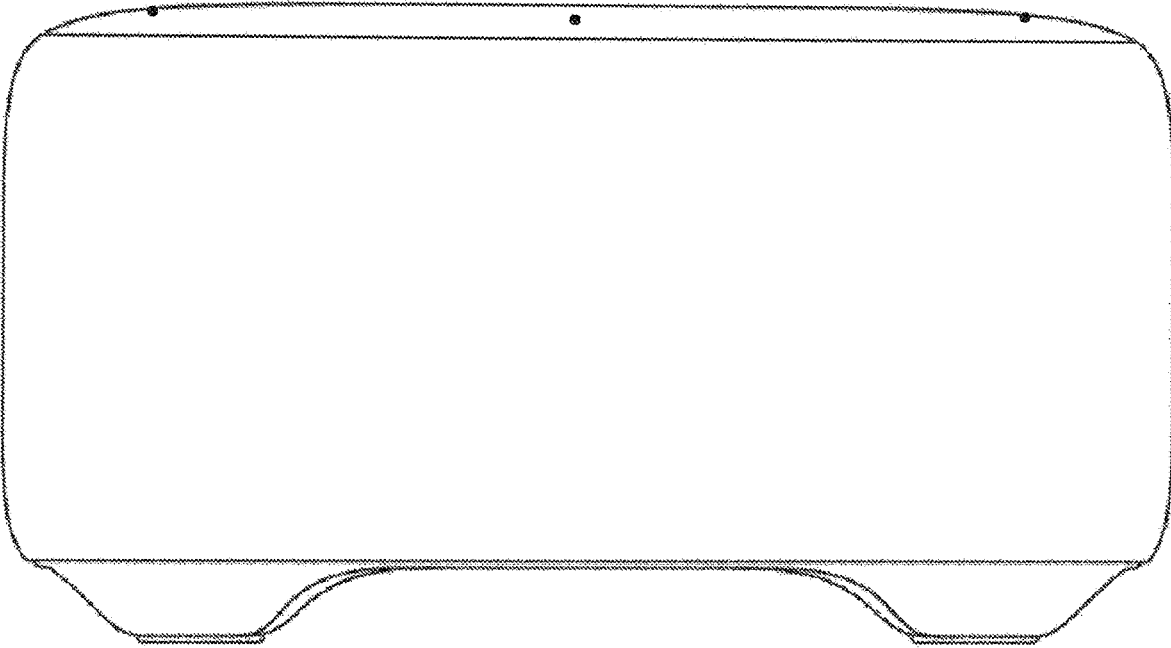

1.5

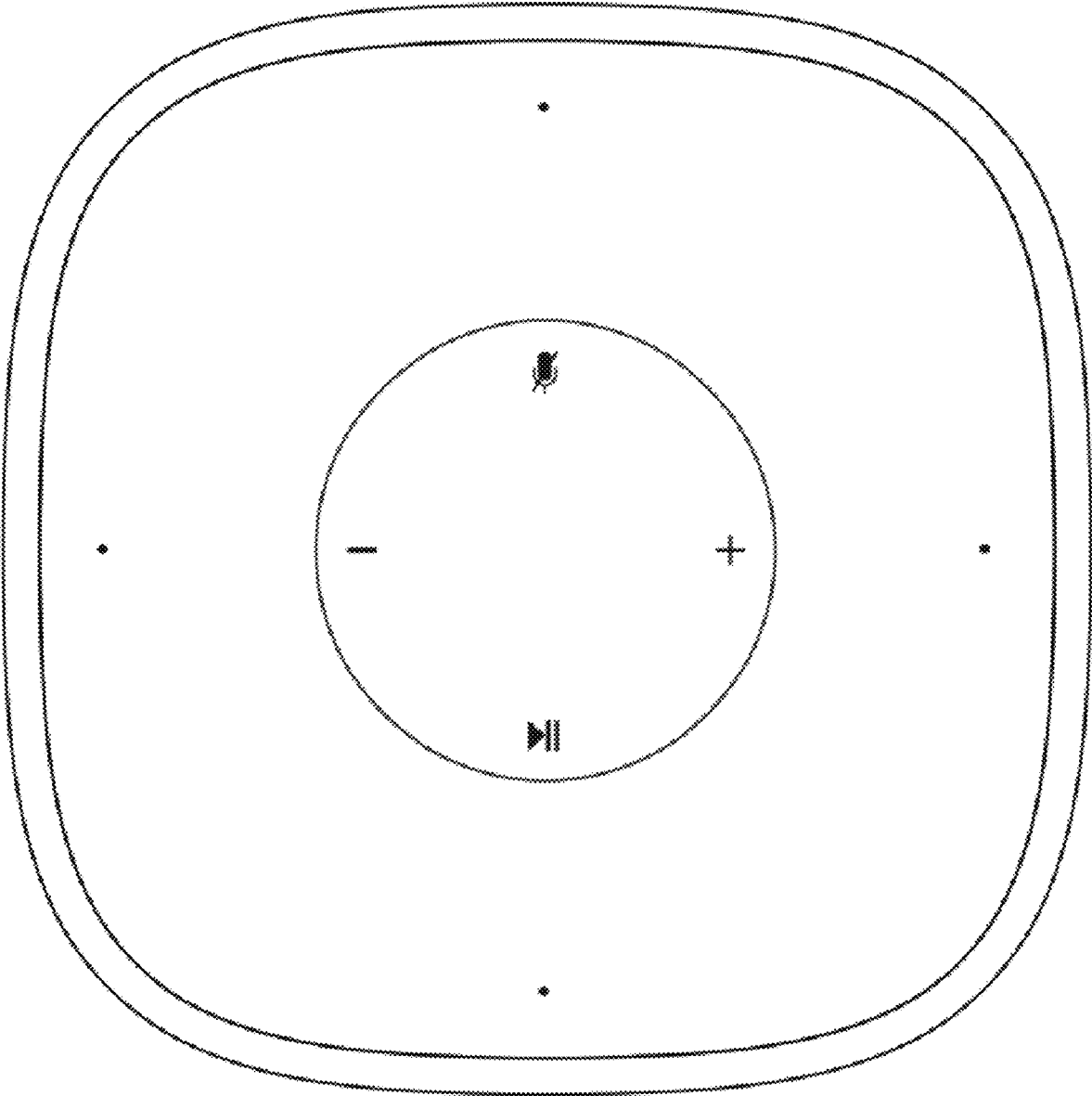

1.6

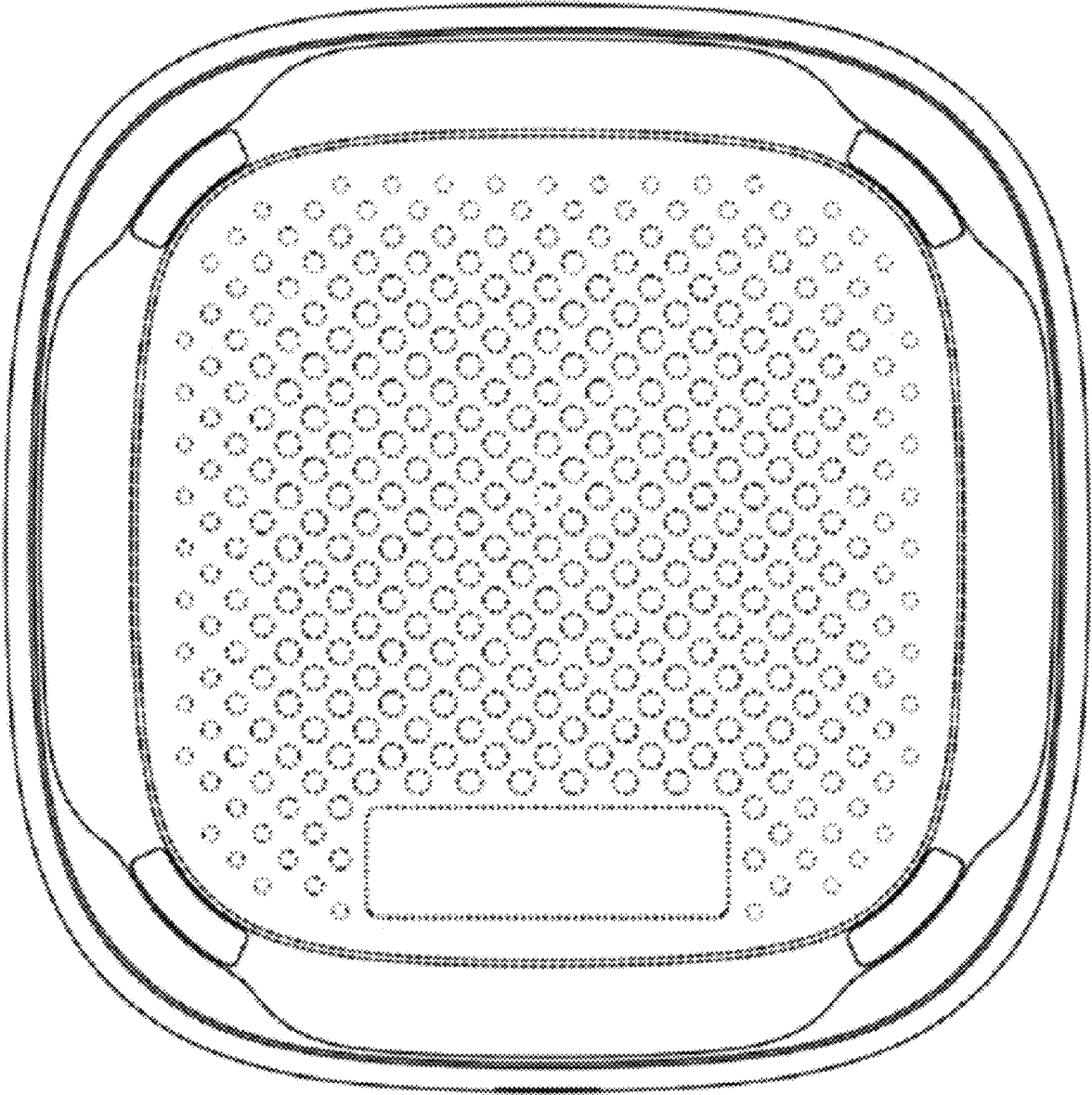

1.7

