

Fig. 1

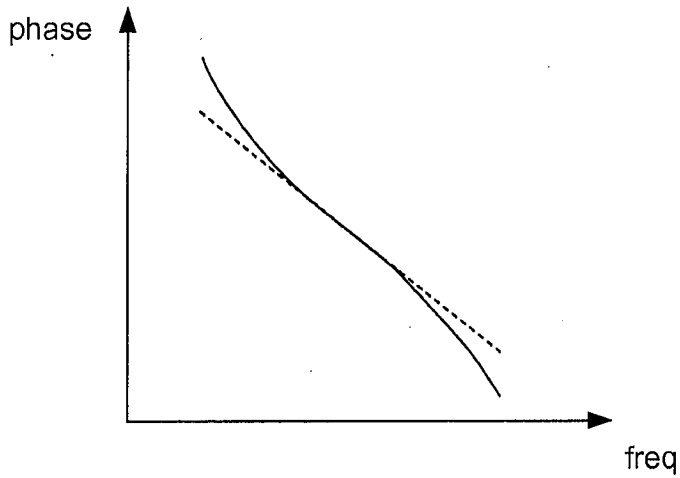
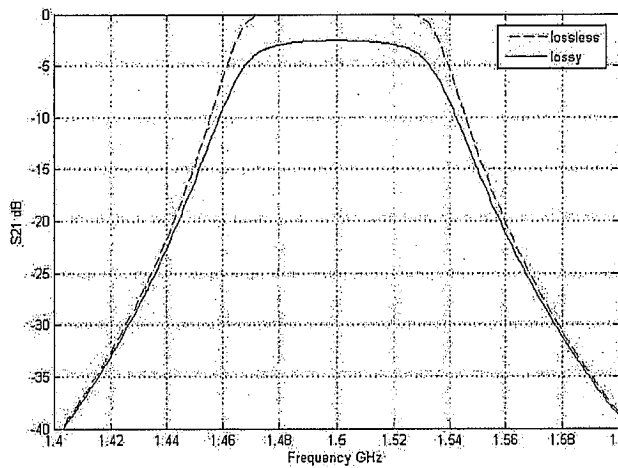

Fig. 2

Fig. 3



  
ROBIN MARK GROSER  
of GROSER & GROSER  
AGENT FOR THE APPLICANTS

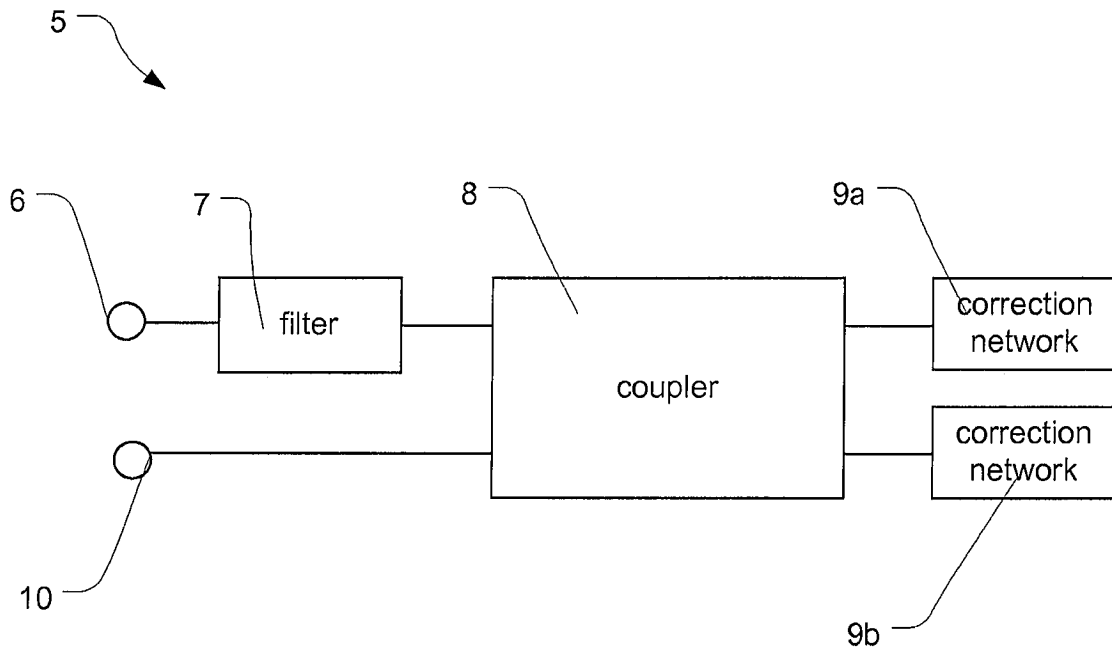

Fig. 4

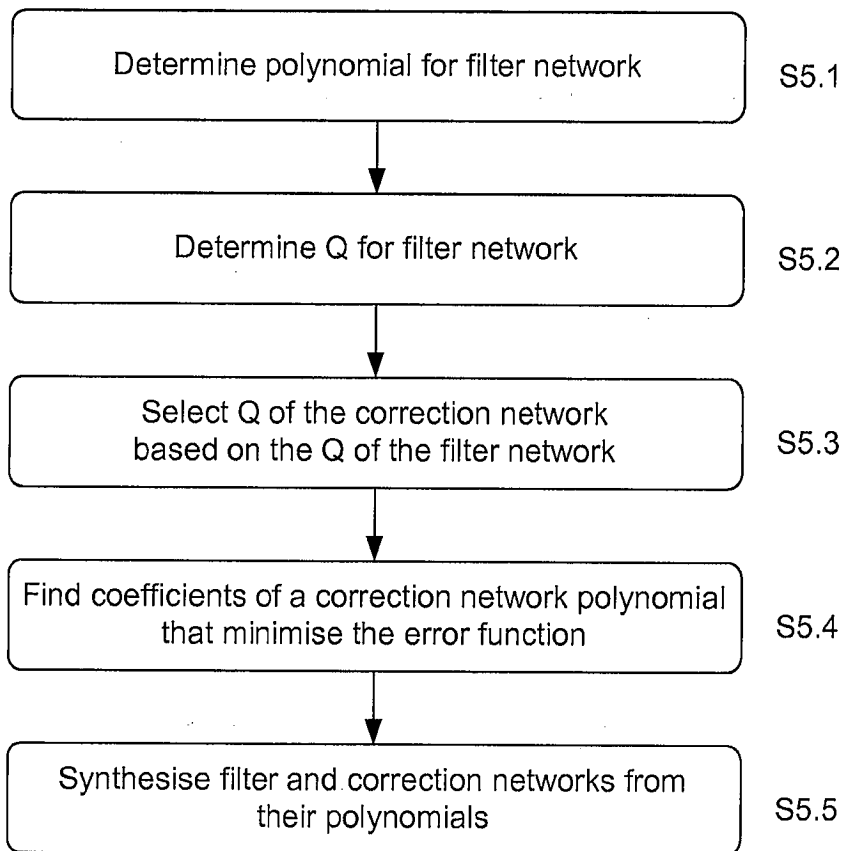

Fig. 5

  
ROBIN MARK GROSER  
of GROSER & GROSER  
AGENT FOR THE APPLICANTS

Fig. 6a

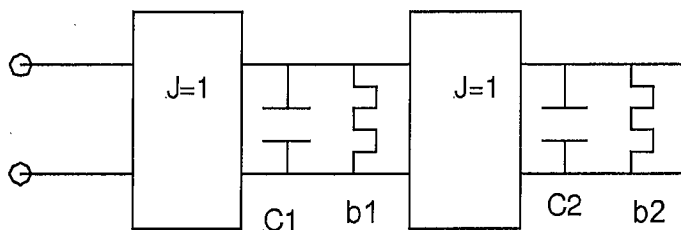

Fig. 6b

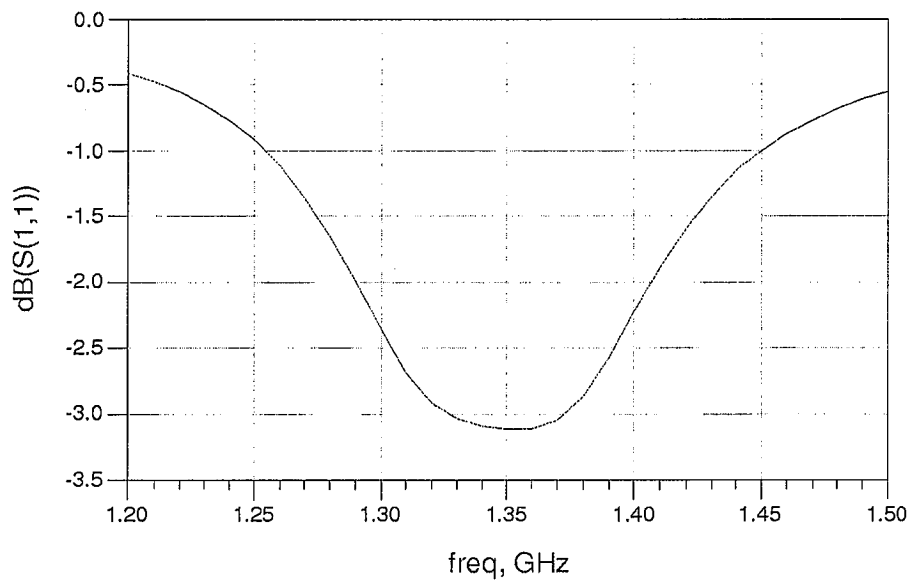
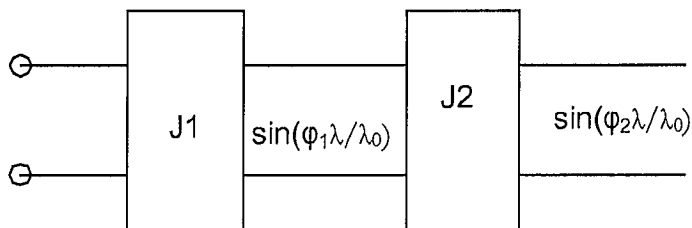

Fig. 7a

  
ROBIN MARK GROSER  
of GROSER & GROSER  
AGENT FOR THE APPLICANTS

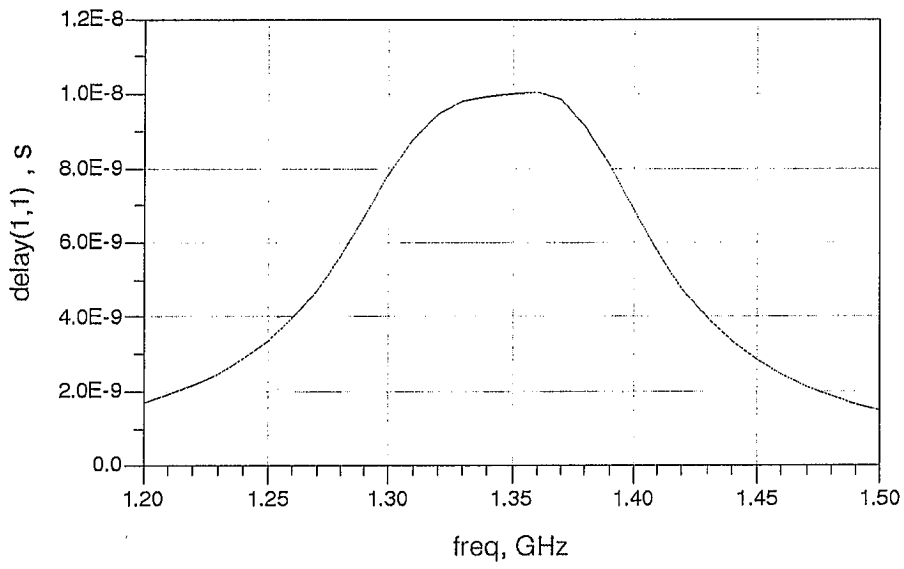
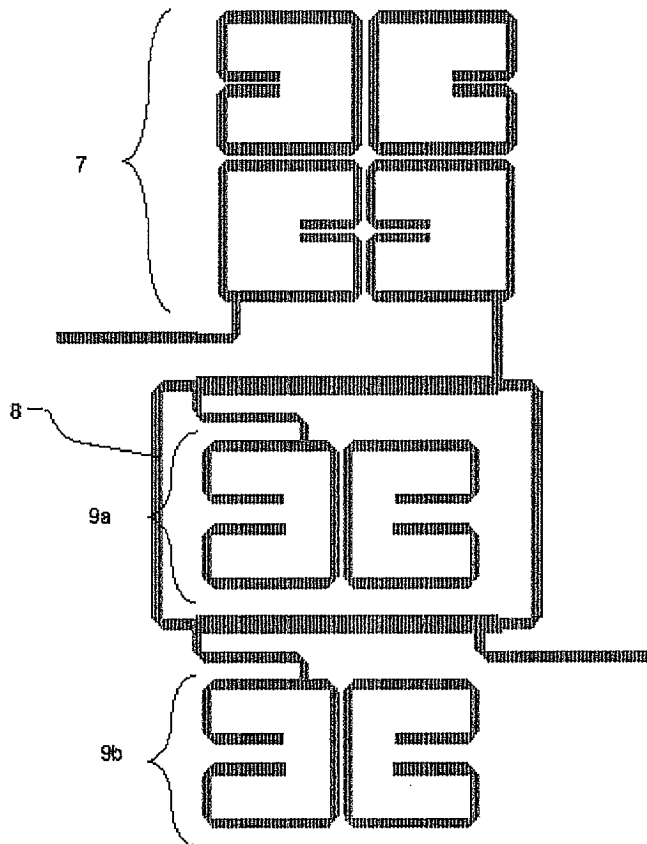

Fig. 7b

Fig. 8



  
ROBIN MARK GROSER  
of GROSER & GROSER  
AGENT FOR THE APPLICANTS

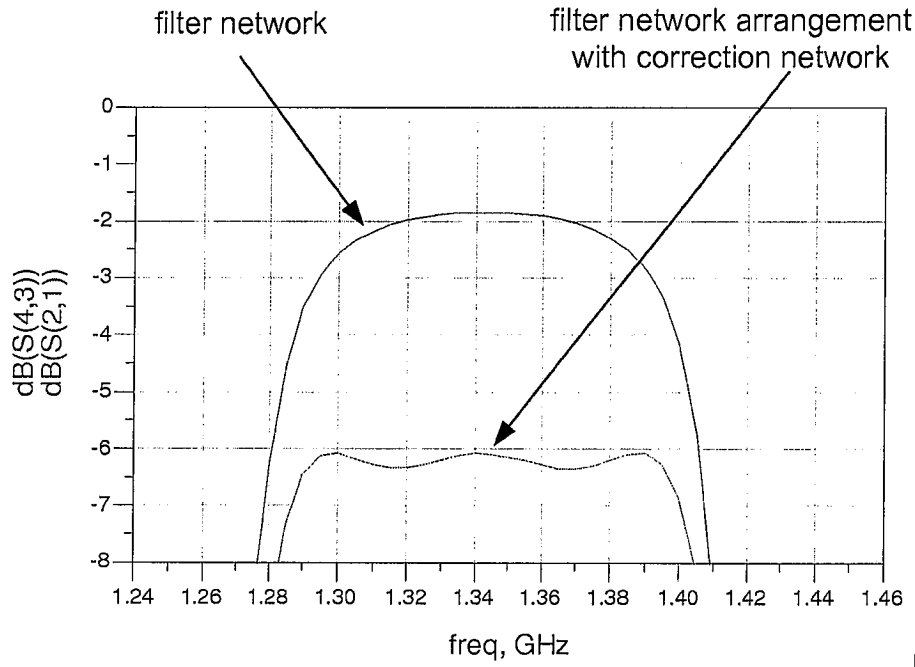

Fig. 9a

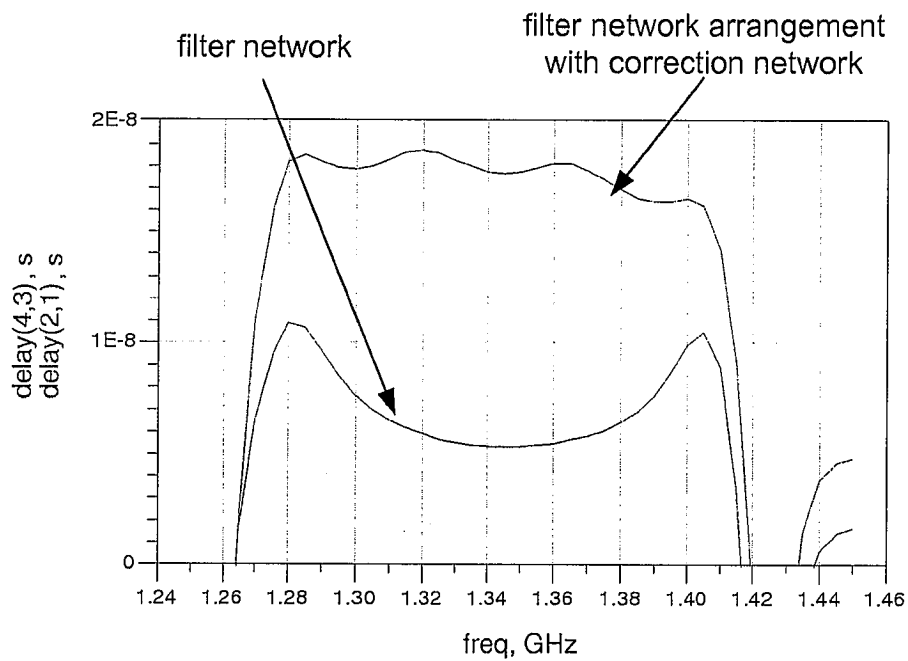

Fig. 9b

*Robin Mark Groser*  
ROBIN MARK GROSER  
of GROSER & GROSER  
AGENT FOR THE APPLICANTS

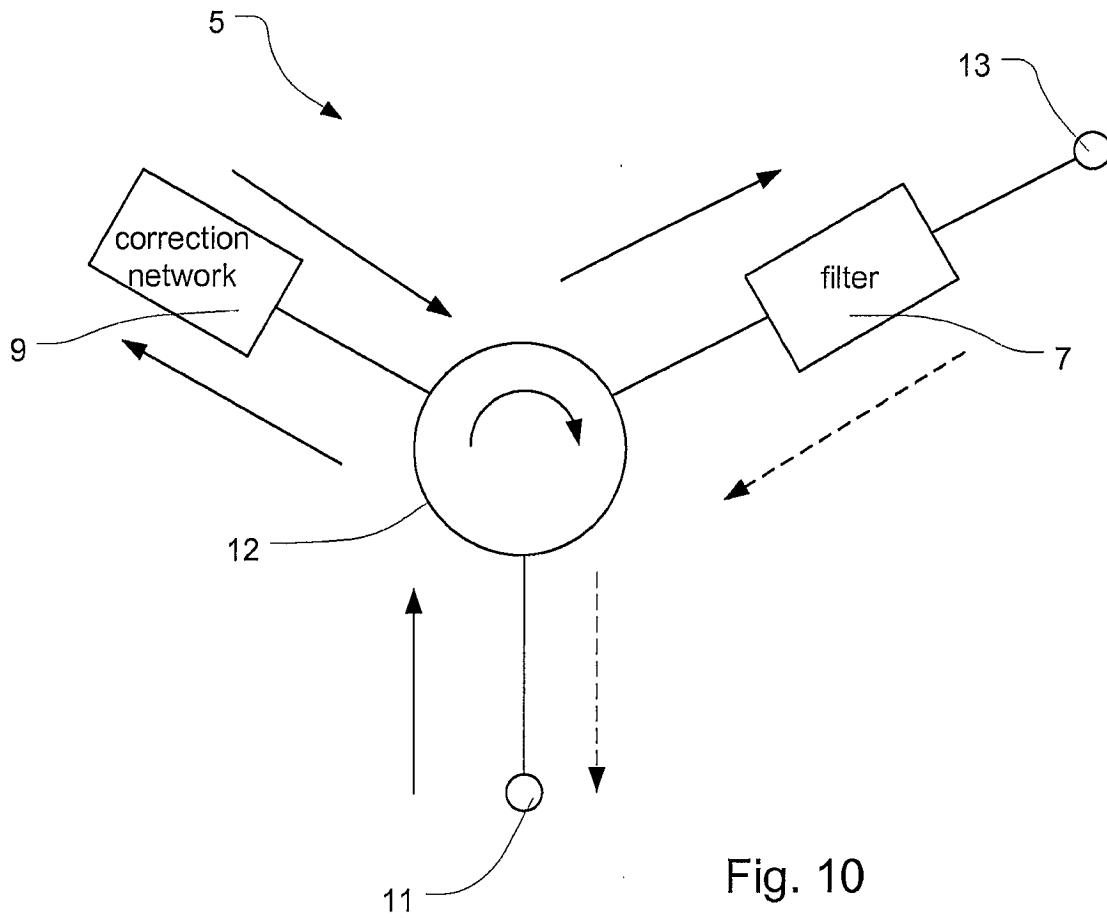

Fig. 10

  
ROBIN MARK GROSER  
of GROSER & GROSER  
AGENT FOR THE APPLICANTS