



(19) **United States**
(12) **Patent Application Publication**
Boone et al.

(10) **Pub. No.: US 2014/0297475 A1**
(43) **Pub. Date: Oct. 2, 2014**

(54) **METHOD AND SYSTEM FOR LISTING ITEMS GLOBALLY AND REGIONALLY, AND CUSTOMIZED LISTING ACCORDING TO CURRENCY OR SHIPPING AREA**

(60) Provisional application No. 60/241,081, filed on Oct. 16, 2000.

Publication Classification

(71) Applicant: **eBay Inc.**, San Jose, CA (US)
(72) Inventors: **Barry Boone**, Seattle, WA (US); **Nathan Sacco**, Los Gatos, CA (US); **Rhys Chard**, Mountain View, CA (US)
(73) Assignee: **eBay Inc.**, San Jose, CA (US)

(51) **Int. Cl.**
G06Q 30/06 (2006.01)
(52) **U.S. Cl.**
CPC **G06Q 30/0623** (2013.01)
USPC **705/26.61**

(21) Appl. No.: **14/231,722**

(57) **ABSTRACT**

(22) Filed: **Mar. 31, 2014**

Related U.S. Application Data

(63) Continuation of application No. 13/550,233, filed on Jul. 16, 2012, now Pat. No. 8,732,037, which is a continuation of application No. 12/693,275, filed on Jan. 25, 2010, now Pat. No. 8,266,016, which is a continuation of application No. 09/905,525, filed on Jul. 13, 2001, now Pat. No. 7,660,740.

In one example embodiment, there is provided a method comprising providing a particular version of a site associated with an electronic marketplace, wherein the electronic marketplace offers a plurality of offerings to a plurality of regions via a plurality of versions of the site; detecting a user access to the particular version of the site; receiving a request from the user and retrieving, based on the request, a region-specific version of an offering available in the region associated with the particular version of the site; and presenting the region-specific version of the offering to the user.

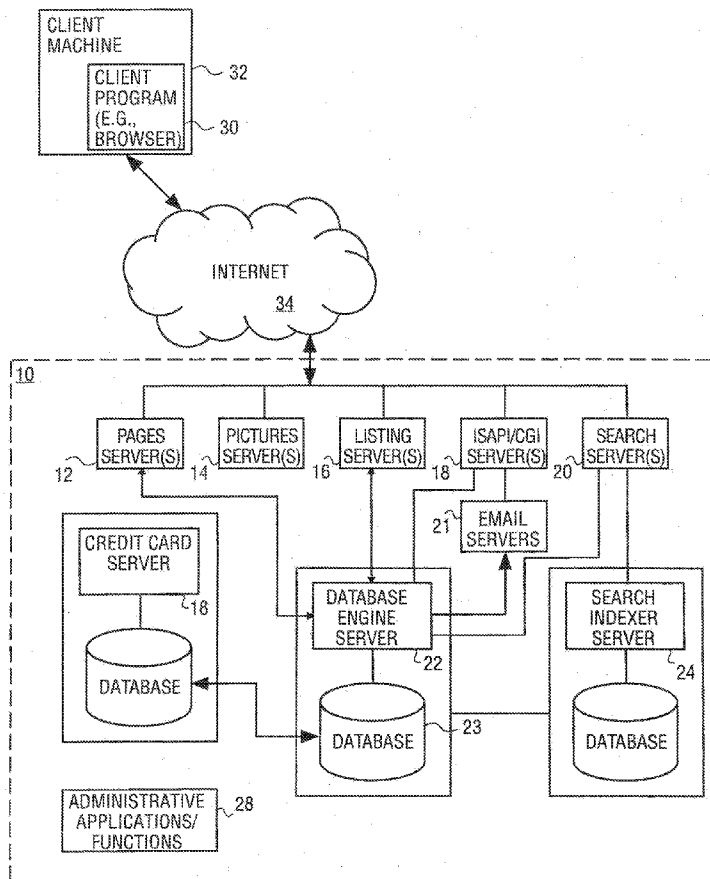

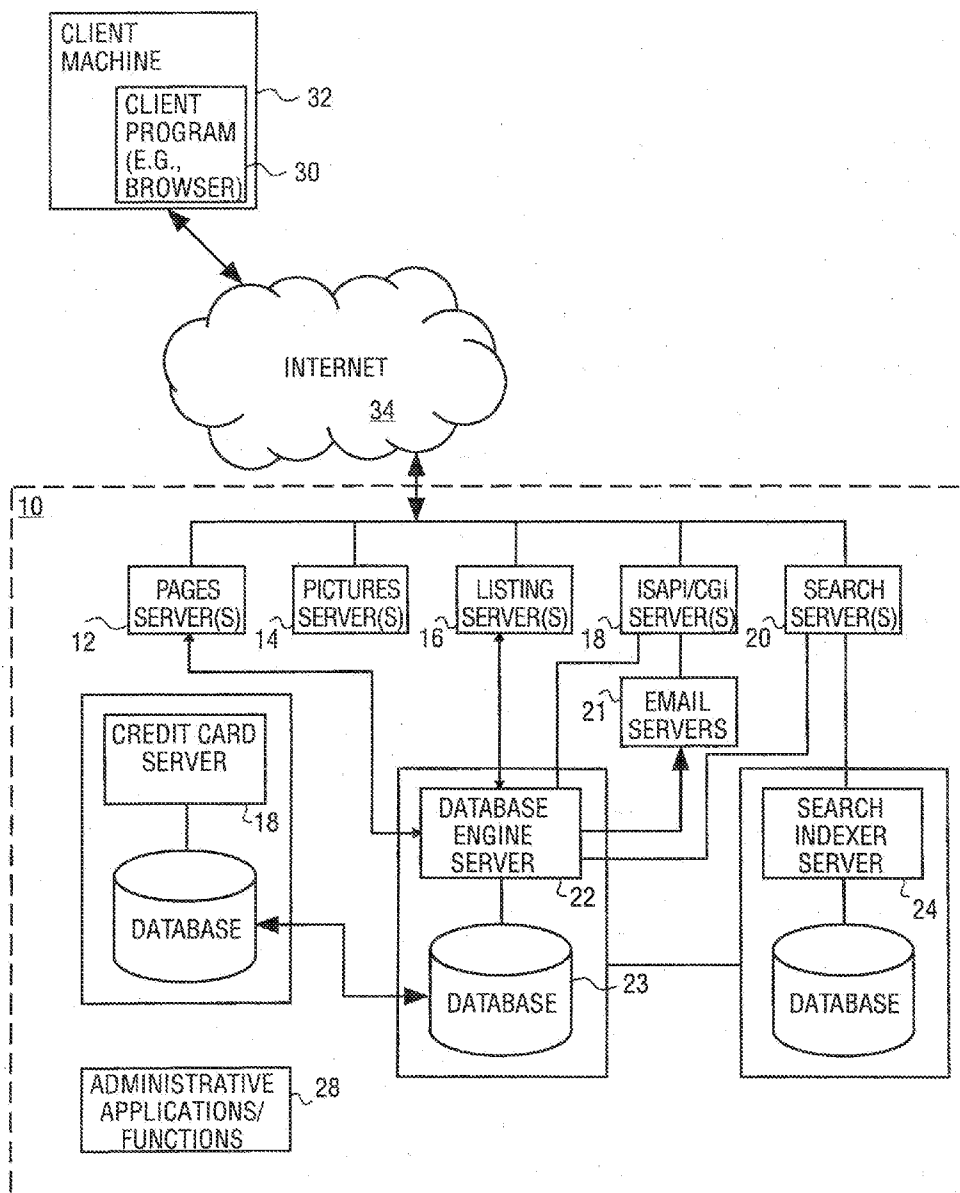

FIG. 1

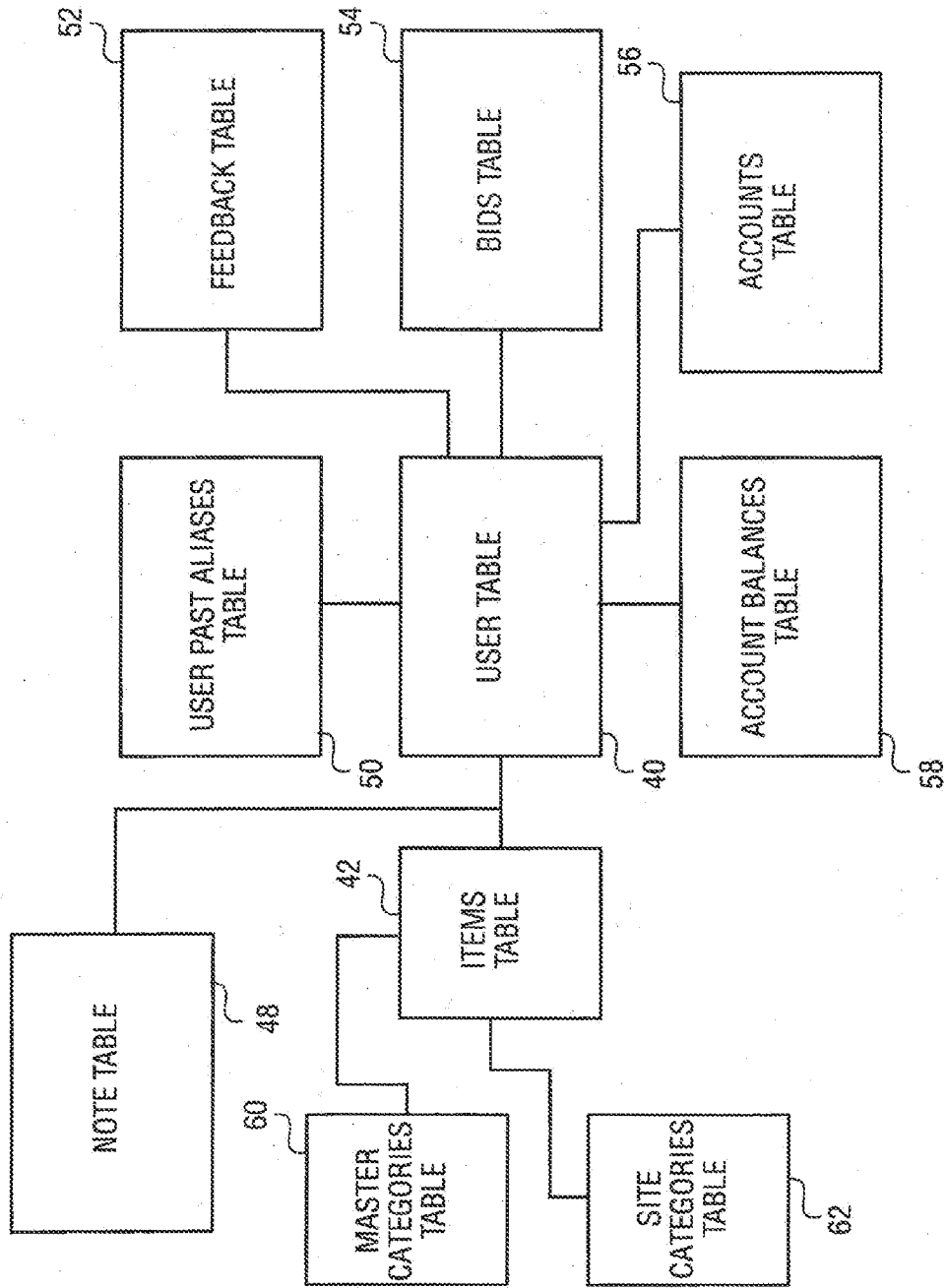

FIG. 2

ITEMS TABLE
ID
SALE_TYPE
TITLE
LOCATION
CATEGORY
CURRENCY
ZIP
BILLING_CURRENCY
SHIPPING_OPTION
SHIP_REGION
DESC_LANGUAGE
SITE_ID

42



FIG. 3A

MASTER CATEGORIES TABLE
CATEGORY_ID
NAME
DESCRIPTION
PARENT_ID
PARENT_NAME

60

FIG. 3B

ITEMS TABLE
SITE_ID
CATEGORY_ID
NAME
DESCRIPTION
PARENT_ID
PARENT_NAME
CURRENCY
LANGUAGE

62

FIG. 3C



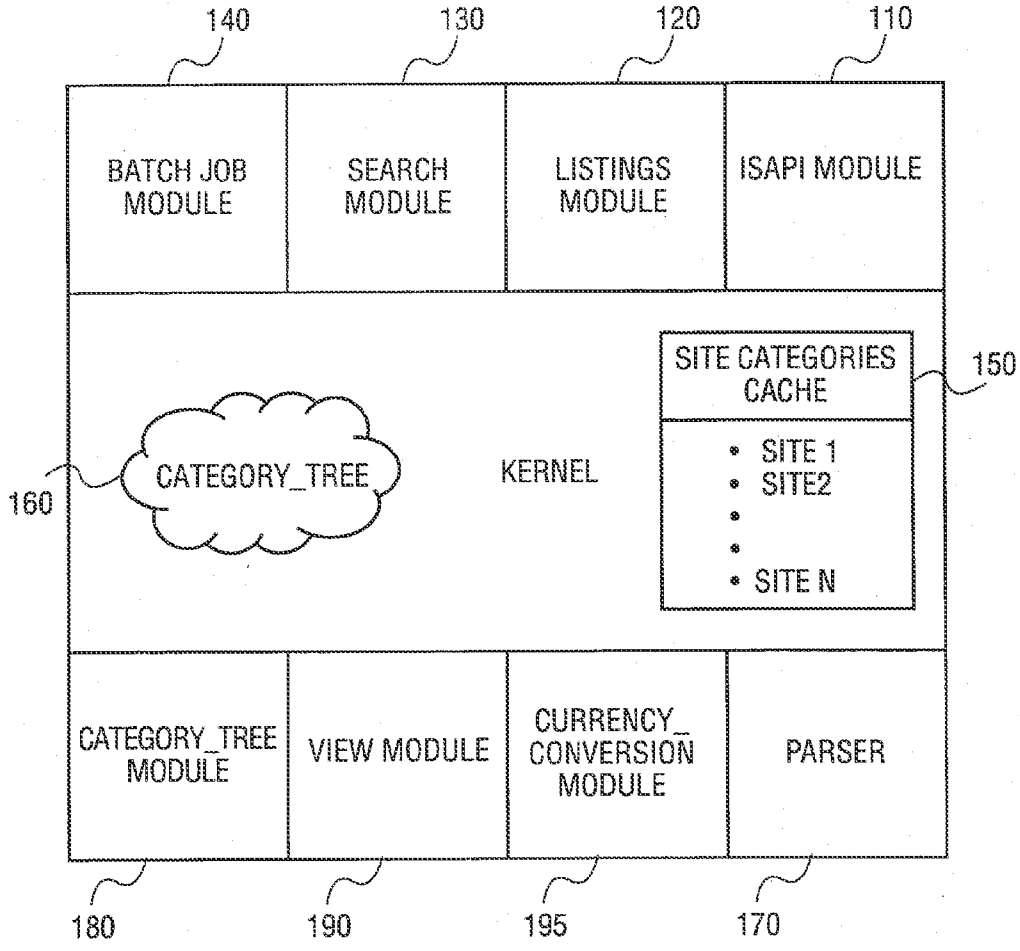

100

FIG. 4

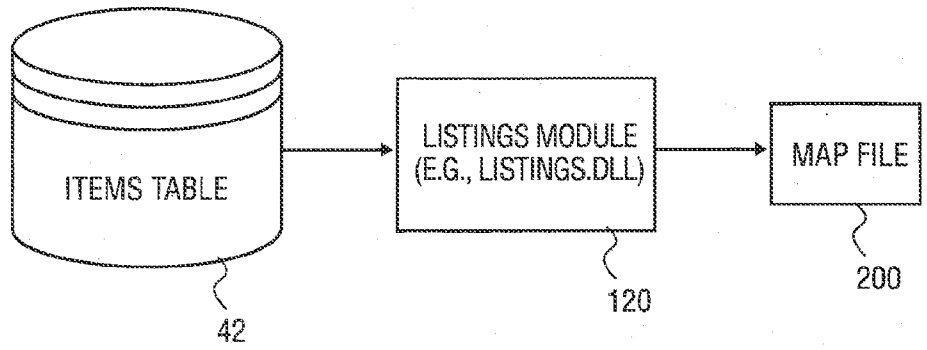

FIG. 5

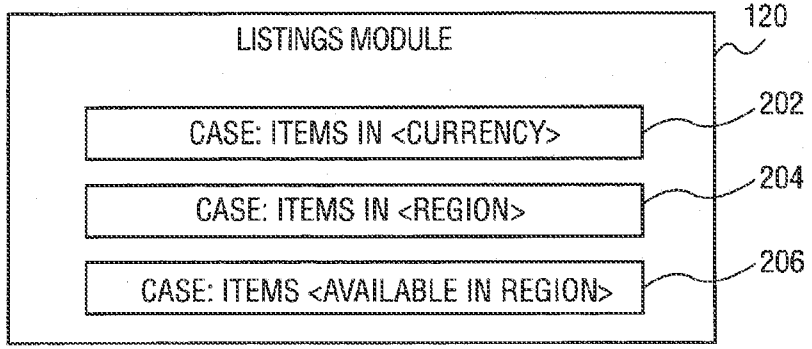

FIG. 6

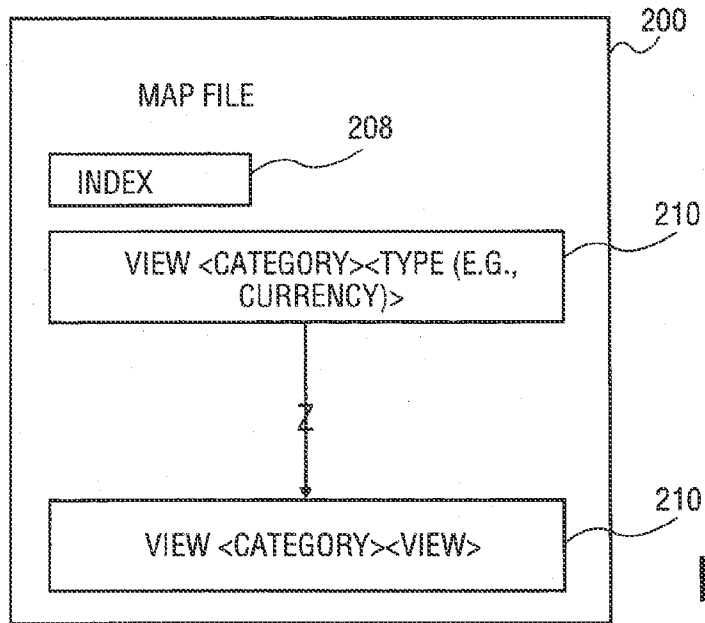

FIG. 7

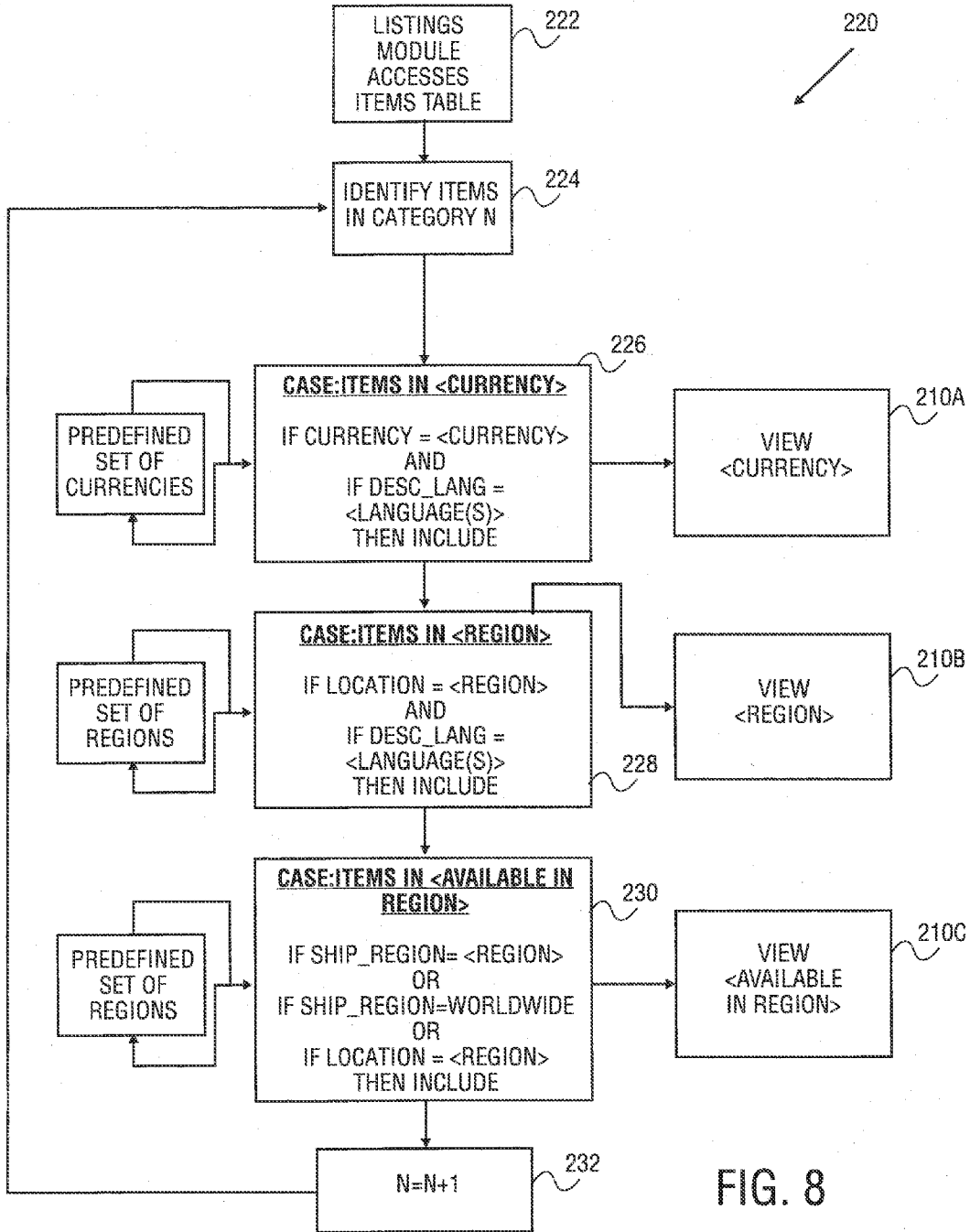

FIG. 8

208

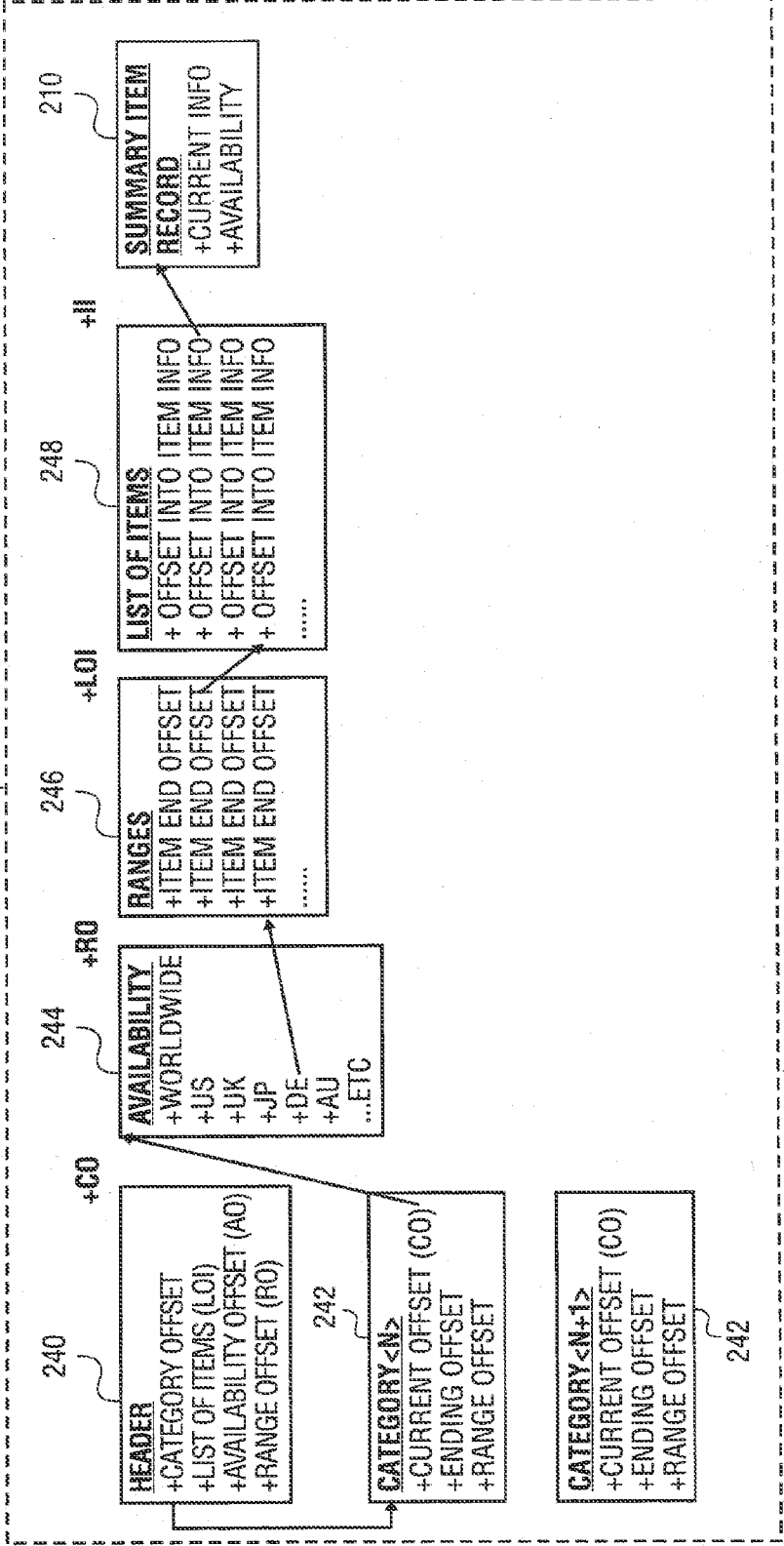

FIG. 9

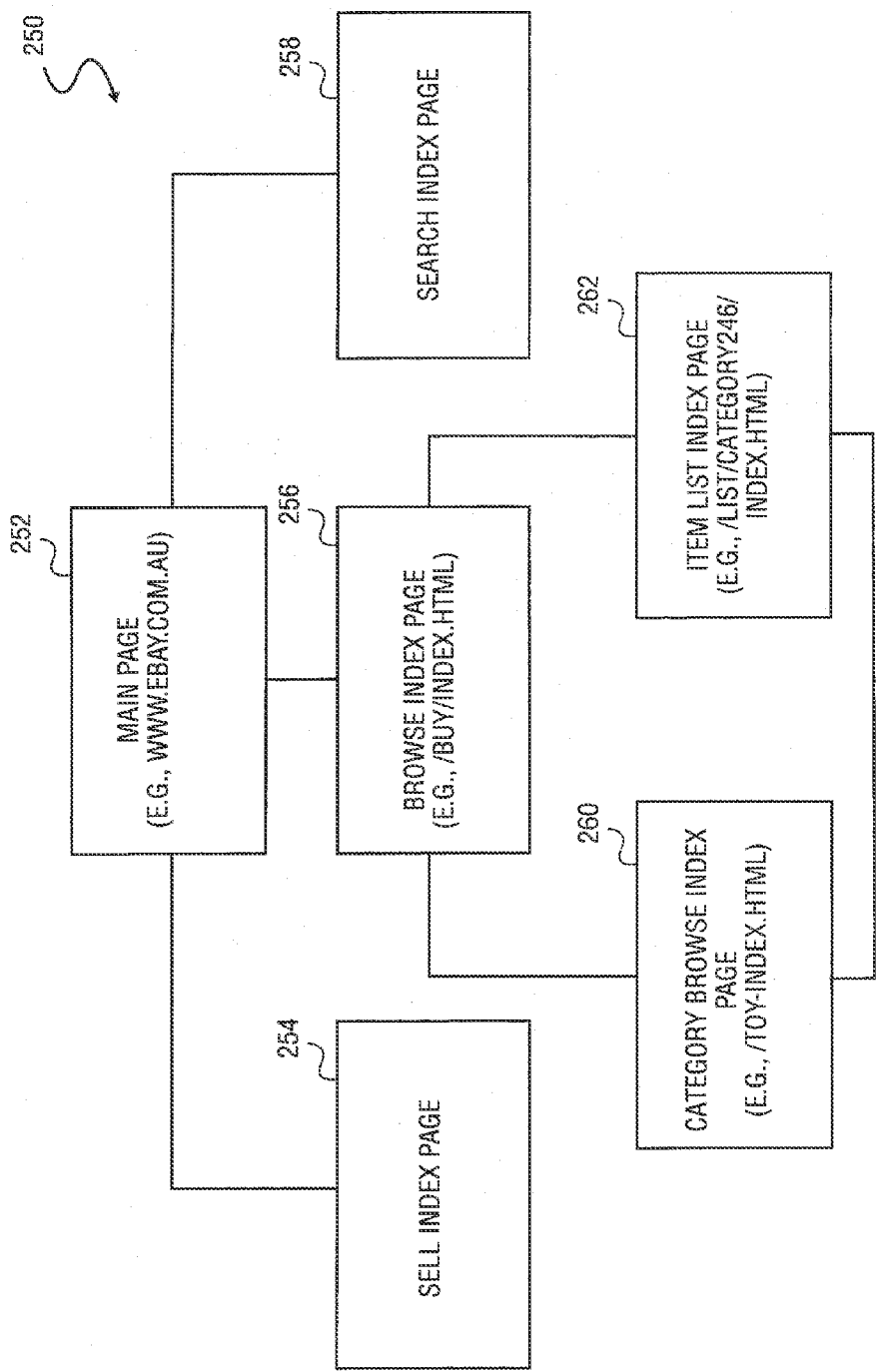

FIG. 10

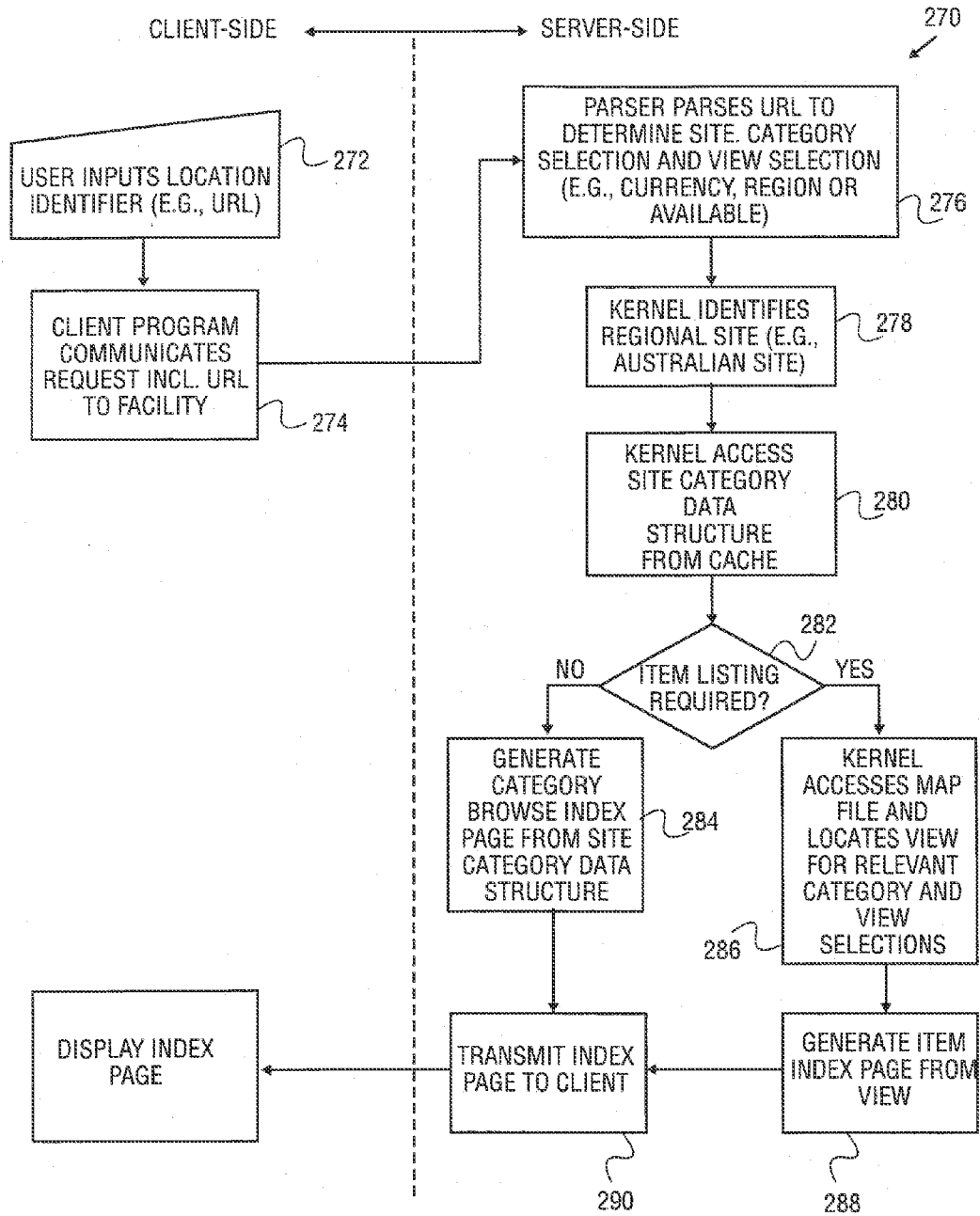

FIG. 11

home | my page | site map | sign in 262

Browse
Sell
Services
Search
Help
Community

all items
gallery items
Shop with pictures!

Search titles and descriptions
 Search tips
Items located in the UK ▼

▷ Create and edit your About Me page.
 ▷ Learn more about [What is eBay?](#)

Updated: 07-Sep 21:30:05 BST Check eBay official time

Top : Books, Films, Music : Books ▶

[Current](#) || [New Today](#) || [Ending Today](#) || [Going, Going, Gone](#) 268

Jump to a list of all items in Books

310
 Items in £

312
 All items located in United Kingdom

314
 All items available to United Kingdom

<p>General (377)</p> <p>First Editions (546) General (490) Signed (56)</p> <p>Audio (50)</p> <p>Children (804) General (378) Classics (80) Early Readers (33) Fairy Tales (18) Mystery, Adventure (66) Mythology (1) Non-Fiction (6) Picture Books (83) Series (128) Young Adult (11)</p> <p>Educational (65) General (5) Business, Finance (7) Encyclopedias (3) Language (11) Reference (13) Science/Technology (8) Self-Help (15) Textbooks (3)</p>	<p>Fiction (1143) General (202) Adventure (68) Fantasy (135) Horror (86) Humour (85) Military (51) Mystery (64) Poetry (9) Romance (233) Sci-Fi (202) Western (10)</p> <p>Non-Fiction (969) General (66) Art (33) Autobiography (121) Collectables (49) Cooking (30) Entertainment (64) Geography (12) History (102) Hobby, Crafts (26) Home & Garden (3) Hunting, Fishing (23) Instructional (10) Military (55) Nature (20) Nautical (16)</p>	<p>Pulps, Club Editions (13) Rare (254)</p>
---	--	---

302
304
306
300

<http://local-listings.ebay.co.uk/law/listings-local/list/category267/index.html>

FIG. 12A

- [Paranormal \(14\)](#)
- [Poetry \(4\)](#)
- [Religion \(23\)](#)
- [Sports \(87\)](#)
- [Travel \(32\)](#)
- [True Crime \(6\)](#)
- [Vehicles \(173\)](#)

262



Featured Auctions in Books

There are no featured items in this category.
 To find out how to be listed in this section and seen by thousands, please visit this link [Featured Auctions](#)

Items in Books

Current

You are on page 1 of 85. [Next Page](#) >

= Gallery = Picture = Hot

Status	Item	Auction Price	Converted Amount*	Bids	Ends BST
	Dorothy Dunnett-Checkmate-UK 1st dj NR	£12.00		1	07-Sep 21:35
	Harry Potter Chamber Secrets UK Deluxe 1st Ed	£57.00		10	07-Sep 21:38
	P.G. Wodehouse. The Jeeves Cocktail book *Pic*	£26.32		4	07-Sep 21:43
	Morag Joss FEARFUL SYMMETRY 1st Ed. UK	£9.99		1	07-Sep 21:45
	William Morris Book Vintage Fabric.	US \$26.00	£18.10	3	07-Sep 21:47
	Nick Hornby ABOUT A BOY 1st Ed. UK	£7.99		1	07-Sep 21:48
	John Le Carre Smiley's People First Ed 1980	US \$20.00	£13.92	-	07-Sep 21:50
	Wind off the Small Isles MARY STEWART '68 dj	US \$26.75	£18.62	9	07-Sep 21:50
	Ogden Nash-Good Intentions-1st UK ed. 1943	£3.50		-	07-Sep 21:52
	Knight Rider 1982 UK Annual	£1.00		-	07-Sep 21:55
	CAPTAINS LOG : UNAUTHORISED GUIDE (SCAN)	£4.00		-	07-Sep 22:02
	Soccer. Tactics and Skills (Football)	£1.35		-	07-Sep 22:02
	Star Wars - book of the original film. (pic)	£4.00		-	07-Sep 22:03
	The Crystal Cave MARY STEWART 1970 UK 1st dj	US \$9.75	£6.79	-	07-Sep 22:03
	Fireball x15 1966 UK Annual RARE NEAR MNT pic	£36.00		5	07-Sep 22:05
	McDougal's Cookery Book	£2.00		1	07-Sep 22:08
	Re-Do Home Recipes	£2.20		2	07-Sep 22:08

FIG. 12B



	Vintage textile Book Colour Prints Provence	US \$50.00	£34.80	-	07-Sep 22:09
	Betty Neels - No need to say goodbye	US \$2.00	£1.39	-	07-Sep 22:14
	In the Troll Wood illus. John Bauer	£10.50		7	07-Sep 22:14
	Betty Neels - Only by chance	US \$2.00	£1.39	-	07-Sep 22:14
	Catalogue du Cabinet Secret du Prince Galitzl	£1.00		-	07-Sep 22:17
	The Hollow Hills MARY STEWART 1973 UK 1st dj	US \$9.75	£6.79	1	07-Sep 22:18
	The Mists of Avalon. Marion Bradley	£2.00		-	07-Sep 22:20
	ILLUSTRATED HISTORY OF WELCH RUGBY UNION	£4.99		-	07-Sep 22:22
	Minette Walters - The Dark Room	US \$2.00	£1.39	1	07-Sep 22:22
	Michael Moorcock - The Fortress of the Pearl	US \$2.00	£1.39	-	07-Sep 22:24
	Day of Judgement. Jack Higgins.	£2.00		-	07-Sep 22:24
	INSOMNIA by Stephen King	US \$13.00	£9.05	-	07-Sep 22:24
	E.C. Tubb - Kalin	US \$2.00	£1.39	-	07-Sep 22:25
	Georgette Heyer - Beauvallet	US \$2.00	£1.39	1	07-Sep 22:26
	Phillippa Carr - A Time for Silence	US \$2.00	£1.39	-	07-Sep 22:27
	Hawksmoor. Peter Ackroyd	£2.00		-	07-Sep 22:27
	Victoria Holt - My Enemy the Queen	US \$2.00	£1.39	-	07-Sep 22:27
	Richard Laymon "Among The Missing" H/back	£2.00		1	07-Sep 22:28
	Victoria Holt - The Curse of the Kings	US \$2.00	£1.39	-	07-Sep 22:29
	Catherine Cookson - Maggie Rowan	US \$2.00	£1.39	-	07-Sep 22:30
	Catherine Cookson - Fanny McBride	US \$2.00	£1.39	1	07-Sep 22:31
	The Horse Rampant. J. J. Pearce	£4.97		2	07-Sep 22:31
	Catherine Cookson - The Round Tower	US \$2.00	£1.39	1	07-Sep 22:32
	6 LADYBIRD BOOKS - DISNEY	£4.99		-	07-Sep 22:35
	Dogs Dogs Dogs Dogs Dogs. Paul Hamlyn Pub.	£2.00		1	07-Sep 22:35
	4 Red Nose Readers - Ahlberg & McNaughton	£5.00		-	07-Sep 22:35
	Palestine Holy Land Syria 1902 Bk. Col.illus	US \$59.95	£41.73	1	07-Sep 22:36
	LADYBIRD BOOKS SET - SAY THE SOUNDS	£4.99		2	07-Sep 22:43
	Catherine Cookson - A Grand Man	US \$2.00	£1.39	1	07-Sep 22:51
	Catherine Cookson - The Nice Bloke	US \$7.51	£5.23	5	07-Sep 22:52

FIG. 12C

262
S

Catherine Cookson - The Black Candle	US \$2.00	£1.39	-	07-Sep 22:53
Catherine Cookson - The Unbaited Trap	US \$2.00	£1.39	1	07-Sep 22:54
Catherine Cookson - Mary Ann and Bill	US \$5.01	£3.49	2	07-Sep 22:55

For more items in this category, click these pages:
= 1 = 2 3 4 5 6 ... 20 ... 40 ... 60 ... 80 ... 95 (next page)

Click on a title to get a description and to bid on that item. A red ending time indicates that an auction is ending in less than five hours. These items are not verified by eBay; caveat emptor. This page is updated regularly; don't forget to use your browser's reload button for the latest version. The system may be unavailable during regularly scheduled maintenance - Please note the regularly scheduled maintenance time is Fridays, 09:00 to 11:00 BST (Fridays, 01:00 a.m. to 05:00 a.m., eBay time).

Updated: 07-Sep 21:30:05 BST Check eBay official time
Use your browser's reload button to see the latest version.

FIG. 12D

home | my page | site map | sign in 262

Browse
Sell
Services
Search
Help
Community

all items
gallery items
Shop with pictures!

Search titles and descriptions
 Search tips

▶ Create and edit your About Me page.
 ▶ Learn more about What is eBay?

Updated: 08-Sep 07:30:05 BST Check eBay official time

Top : Books, Films, Music : Books

Current || [New Today](#) || [Ending Today](#) || [Going, Going, Gone](#)

[Jump to a list of all items in Books](#)

[Items in AU\\$](#)

All items located in
Australia

All items available to Australia

[General \(137\)](#)
[Audio \(5\)](#)

[Business & Educational \(122\)](#)
[General \(7\)](#)
[Business, Finance \(5\)](#)
[Computers, Internet \(13\)](#)
[Homeschool \(1\)](#)
[Language \(10\)](#)
[Medical \(10\)](#)
[Reference \(31\)](#)
[Science/Technology \(28\)](#)
[Self-Help \(11\)](#)
[Textbooks \(6\)](#)

[Children \(680\)](#)

[General \(258\)](#)
[Antique \(31\)](#)
[Classics \(87\)](#)
[Early Readers \(11\)](#)
[Fairy Tales \(21\)](#)
[Little Golden Books \(30\)](#)
[Mystery, Adventure \(71\)](#)
[Non-Fiction \(5\)](#)
[Picture Books \(40\)](#)
[Series \(105\)](#)
[Young Adult \(21\)](#)

[Fiction \(903\)](#)

[General \(384\)](#)
[Adventure \(29\)](#)
[Fantasy \(67\)](#)
[Horror \(45\)](#)
[Humour \(66\)](#)
[Military \(10\)](#)
[Mystery \(76\)](#)
[Poetry \(41\)](#)
[Romance \(70\)](#)
[Sci-Fi \(115\)](#)

[First Editions \(147\)](#)

[General \(135\)](#)
[Signed \(12\)](#)

[Non-Fiction \(1131\)](#)

[General \(70\)](#)
[Arts, Entertainment \(36\)](#)
[Auto/Biography \(149\)](#)
[Collectibles \(18\)](#)
[Cooking \(37\)](#)
[Entertainment \(31\)](#)
[History \(119\)](#)
[Hobby, Crafts \(52\)](#)
[Home & Garden \(30\)](#)
[Hunting, Fishing \(9\)](#)
[Instructional \(28\)](#)
[Military \(202\)](#)

[Paperbacks \(51\)](#)
[Rare \(82\)](#)

FIG. 13A

262

- Nature (39)
- New Age & Paranormal (70)
- Poetry (7)
- Religion & Philosophy (85)
- Sports (39)
- Travel (52)
- True Crime (11)
- Vehicles (47)

Featured Auctions in Books

Status	Item	Auction Price	Converted Amount*	Bids	Ends BST
	ELLIOTT, NATURES LAW Stock market wave theory	AU \$249.00		-	08-Sep 09:47
	CHARLES DICKENS - MARTIN CHUZZLEWIT 1844 1st	AU \$349.00		-	14-Sep 11:31

To find out how to be listed in this section and seen by thousands, please visit this link [Featured Auctions](#)

Items in Books

Current

You are on page 1 of 66. [Next Page](#) >

Status	Item	Auction Price	Converted Amount*	Bids	Ends BST
	SAVAGE GARDEN - Pictorial Book With Poster	US \$5.50	AU \$9.46	2	08-Sep 08:58
	ELLIOT, NATURES LAW Stock market wave theory	AU \$249.00		-	08-Sep 09:47
	FAIRIES IN FRANCE--FELIX LORIOUX - OSTROGA	AU \$129.00		-	08-Sep 09:50
	Remember - By Barbara Taylor Bradford	AU \$3.00		-	08-Sep 09:51
	GEORGE BAWLINSON, ANCIENT EGYPT -----1895	AU \$39.00		1	08-Sep 09:52
	MONSARRAT, THE MASTER MARINER Vols 1&2 1st Ed	AU \$39.00		-	08-Sep 09:53
	LANE-POOLE, THE BARBARY CORSAIRS 1896 pirates	AU \$49.00		1	08-Sep 09:54
	What Katy Did At School - Susan Coolidge	AU \$3.00		-	08-Sep 10:03
	Barb. Taylor Bradford - The Woman in his life	AU \$3.00		-	08-Sep 10:09
	Wagon Train Emily Broun 1958 LGB	US \$7.00	AU \$12.42	-	08-Sep 10:14

FIG. 13B

262



	MASTER-STROKE...Marilyn Sharp	AU \$1.00	-	08-Sep 10:14
	XAVIERA...BY XAVIERA HOLLANDER	AU \$1.50	-	08-Sep 10:16
	THE KGB DIRECTIVE...RICHARD COX	AU \$1.50	-	08-Sep 10:17
	THE COMMISSAR'S REPORT...MARTYN BURKE	AU \$1.00	-	08-Sep 10:18
	THREADS...B A HIRSCH	AU \$2.00	-	08-Sep 10:19
	Ann Rule 3-in-1 True Crime hardback w/dj	AU \$17.00	2	08-Sep 10:33
	Star Trek Movie Memories new William Shatner	AU \$4.40	1	08-Sep 10:34
	Star Trek Movie Memories new William Shatner	AU \$4.40	-	08-Sep 10:34
☐	TROUBLE FOR SKINHEAD RICHARD ALLEN 1974 BOOK	US \$15.50	AU \$27.51	7 08-Sep 10:34
	Ancestors - Robyn Davidson	AU \$3.00	-	08-Sep 10:40
☐	GUNSMOKE Seymour Reit 1974 LGB	US \$7.00	AU \$12.42	- 08-Sep 10:44
☐	PETER RABBIT-Beatrix Potter-Dinner Set-AUSSIE	US \$19.99	AU \$35.48	1 08-Sep 11:01
☐	STRANGE CASE OF THE END OF CIVILISATION MOVIE	US \$4.00	AU \$7.10	1 08-Sep 11:02
☐	KEN HOLT MYSTERY OF THE GREEN FLAME 1958	US \$4.00	AU \$7.10	2 08-Sep 11:29
☐	Tom & Jerry meet little Quack 1972 LGB	US \$4.00	AU \$7.10	- 08-Sep 11:30
☐	Chitty Chitty Bang Bang 1974 LGB	US \$8.00	AU \$14.20	- 08-Sep 11:42
☐	Biography-HENRY FONDA-1982-SB-career&personal	AU \$6.50	-	08-Sep 11:53
☐	Lassie & the Big Clean-up day 1972 LGB	US \$7.00	AU \$12.42	- 08-Sep 11:58
☐	THE WOMAN AND THE CAR	US \$25.00	AU \$44.37	- 08-Sep 12:07
☐	Christmas Carols RARE ERROR version LGB 1961	US \$7.00	AU \$12.42	- 08-Sep 12:10
☐	Disneys OLD YELLER LGB 1959	US \$7.00	AU \$12.42	- 08-Sep 12:14
☐	The Motoring Montagus	US \$15.00	AU \$26.62	- 08-Sep 12:20
☐	Disney SNOW WHITE & seven dwarfs LGB 1972	US \$7.00	AU \$12.42	- 08-Sep 12:23

FIG. 13C



	Power Operated Hood s/Rolls-Royce/Bentley	US \$12.00	AU \$21.30	2	08-Sep 12:30
	ROLLS-ROYCE Coachwork Sketches.	US \$18.50	AU \$32.83	4	08-Sep 12:41
	TARZAN LGB 1964 edgar rice burroughs	US \$7.00	AU \$12.42	-	08-Sep 12:48
	The Three Litre BENTLEY	US \$16.50	AU \$29.28	4	08-Sep 12:52
	ROLLS-ROYCE Bulletin June 1939	US \$15.00	AU \$26.62	-	08-Sep 13:01
	Sir John Constantine by "Q"	AU \$5.00		-	08-Sep 13:07
	Hop, little Kangaroo 1973 LGB	AU \$9.00		-	08-Sep 13:14
	Pepper plays Nurse 1964 LGB	AU \$5.00		-	08-Sep 13:35
	AIREPLANES 1973 LGB	AU \$6.00		-	08-Sep 13:43
	Dr Dan the bandage man 1977 LGB	AU \$9.00		-	08-Sep 13:54
	Return to OZ 1985 LGB wizard of oz	AU \$9.00		-	08-Sep 14:01
	disneys The Rescuers 1977 LGB	AU \$9.00		-	08-Sep 14:17
	Jack & the Beanstalk 1955 LGB	AU \$9.00		-	08-Sep 14:24
	Johann Wolfgang von Goethe life mask taust	US \$49.00	AU \$86.96	-	08-Sep 14:24
	ENID BLYTON - FAMOUS FIVE X 2 STORIES	US \$2.00	AU \$3.55	-	08-Sep 14:30
	JOHN KEATS LIFE MASK POET SHELLEY	US \$39.00	AU \$69.22	-	08-Sep 14:31
	ENID BLYTON - 10 x MYSTERY AND ADVENTURE - PB	US \$4.99	AU \$8.86	-	08-Sep 14:41

For more items in this category, click these pages:
= 1 = 2 3 4 5 6 ... 20 ... 40 ... 60 ... 66 (next page)

Click on a title to get a description and to bid on that item. A red ending time indicates that an auction is ending in less than five hours. These items are not verified by eBay; caveat emptor. This page is updated regularly; don't forget to use your browser's reload button for the latest version. The system may be unavailable during regularly scheduled maintenance - Please note the regularly scheduled maintenance time is Fridays, 09:00 to 11:00 BST (Fridays, 01:00 a.m. to 05:00 a.m., eBay time).

Updated: 08-Sep 7:30:05 EDT Check eBay official time
Use your browser's reload button to see the latest version.

FIG. 13D

home | my page | site map | sign in 262

Browse
Sell
Services
Search
Help
Community

all items
gallery items
Shop with pictures!

Search titles and descriptions
 tips

[▶ Create and edit your About Me page.](#)
[▶ Learn more about What is eBay?](#)

Updated: 08-Sep 07:30:05 BST Check eBay official time

Top : Books, Films, Music : Books

[Current](#) || [New Today](#) || [Ending Today](#) || [Going, Going, Gone](#)

[Jump to a list of all items in Books](#)

[items in AU \\$](#)

[All items located in Australia](#)

[All items available to Australia](#)

General (6075)

Audio (2989)

Business & Educational (11072)

[General \(994\)](#)

[Business, Finance \(1117\)](#)

[Computers, Internet \(664\)](#)

[Homeschool \(1422\)](#)

[Language \(503\)](#)

[Medical \(1178\)](#)

[Reference \(1170\)](#)

[Science/Technology \(1132\)](#)

[Self-Help \(1656\)](#)

[Textbooks \(1236\)](#)

Children (18133)

[General \(4598\)](#)

[Antique \(1453\)](#)

[Classics \(1873\)](#)

[Early Readers \(1242\)](#)

[Fairy Tales \(568\)](#)

[Little Golden Books \(1091\)](#)

[Mystery, Adventure \(1213\)](#)

[Non-Fiction \(720\)](#)

[Picture Books \(1294\)](#)

[Series \(2821\)](#)

[Young Adult \(1260\)](#)

Fiction (27405)

[General \(6406\)](#)

[Adventure \(1947\)](#)

[Fantasy \(2234\)](#)

[Horror \(1427\)](#)

[Humour \(1136\)](#)

[Military \(535\)](#)

[Mystery \(4510\)](#)

[Poetry \(546\)](#)

[Romance \(4628\)](#)

[Sci-Fi \(4036\)](#)

First Editions (7124)

[General \(5790\)](#)

[Signed \(1334\)](#)

Non-Fiction (52001)

[General \(4921\)](#)

[Arts, Entertainment \(3374\)](#)

[Auto/Biography \(4980\)](#)

[Collectibles \(2038\)](#)

[Cooking \(4792\)](#)

[Entertainment \(1869\)](#)

[History \(7150\)](#)

[Hobby, Crafts \(2633\)](#)

[Home & Garden \(1443\)](#)

[Hunting, Fishing \(1126\)](#)

[Instructional \(2025\)](#)

[Military \(3221\)](#)

302

304

306

<http://local-listings.ebay.co.uk/law/listings-avail/list/all/category267/index.html>

FIG. 14A

262

[Nature \(1594\)](#)
[New Age & Paranormal \(1120\)](#)
[Poetry \(588\)](#)
[Religion & Philosophy \(4216\)](#)
[Sports \(1711\)](#)
[Travel \(1398\)](#)
[True Crime \(638\)](#)
[Vehicles \(1164\)](#)



Featured Auctions in Books

= Gallery
 = Picture
 = Hot

Status	Item	Auction Price	Converted Amount*	Bids	Ends BST
	ELLIOTT, NATURES LAW Stock market wave theory	AU \$249.00		-	08-Sep 09:47
	CHARLES DICKENS - MARTIN CHUZZLEWIT 1844 1st	AU \$349.00		-	14-Sep 11:31

To find out how to be listed in this section and seen by thousands, please visit this link [Featured Auctions](#)

Items in Books

Current

You are on page 1 of 66. [Next Page](#) ▶

= Gallery
 = Picture
 = Hot

Status	Item	Auction Price	Converted Amount*	Bids	Ends BST
	1952 Clinical laboratory diagnosis w/illustr.	US \$9.99	AU \$17.73	-	08-Sep 07:30
	Ask Mr. Bear Vintage Old Book NR	US \$3.25	AU \$5.77	4	08-Sep 07:30
	Sweet Texas Wildfire by Lauren Wilde-Historic	US \$1.00	AU \$1.77	-	08-Sep 07:30
	CREATION CRAFTS	US \$1.00	AU \$1.77	1	08-Sep 07:30
	One Man's Island David Conover biography	US \$3.95	AU \$7.01	-	08-Sep 07:30
	SOLVE YOUR CHILD'S SLEEP PROBLEMS - FERBER	US \$7.01	AU \$12.44	4	08-Sep 07:30
	Janet Dailey - 3 P.B/1 HC - Illusions, etc.	US \$2.00	AU \$3.55	-	08-Sep 07:31
	Mormon Apostle, Captain Fear Not, LDS.	US \$9.99	AU \$17.73	-	08-Sep 07:31
	Rachel's Choice-Judith French-Like New-PB-NR	US \$2.00	AU \$3.55	1	08-Sep 07:31
	1942 Boots Mystery Of The Unlucky Vace Book	US \$2.99	AU \$5.31	-	08-Sep 07:31
	awake and away school text pic	US \$35.00	AU \$62.12	-	08-Sep 07:31

FIG. 14B

	George Elio Works vol. VIII MIDDLEMARCH 1911	US \$8.00	AU \$14.20	-	08-Sep 07:31
	Ngaio Marsh-"A Wreath for Rivera"	US \$5.00	AU \$8.87	-	08-Sep 07:31
	FISH AND GAME COOKING COOKBOOK	US \$7.99	AU \$14.18	1	08-Sep 07:31
	LOVE 49 Poems of Love	US \$2.00	AU \$3.55	-	08-Sep 07:31
	The O'Connors--Karen Young--Like New! --PB--NR	US \$2.00	AU \$3.55	-	08-Sep 07:31
	an Ill Fate Marshalling by Glen Cook. NR	US \$5.00	AU \$8.87	1	08-Sep 07:31
	CRIMINAL CONVERSATION	US \$9.99	AU \$17.73	-	08-Sep 07:32
	ALCOTT: EIGHT COUSINS.ILLUS. OLD GORGEIOUS	US \$7.99	AU \$14.18	-	08-Sep 07:32
	Savage Persuasion--Edwards--Like New! --PB--NR	US \$2.00	AU \$3.55	-	08-Sep 07:32
	Art Instruction Books 1 dozen 1950-1989	US \$8.00	AU \$14.20	4	08-Sep 07:32
	LONDON, Sidney Cark III, Joseph Pennell 1936	US \$7.00	AU \$12.42	1	08-Sep 07:32
	Snow Kisses--Carlow--Harte--Mail--Like New!--PB--NR	US \$2.00	AU \$3.55	-	08-Sep 07:32
	Illustrated Encyclopadia Of Symbols	US \$3.75	AU \$6.66	3	08-Sep 07:32
	Ginny Gordon & The Missing Heirloom-50's Book	US \$9.99	AU \$17.73	-	08-Sep 07:32
	PETAL PORCELAIN PROJECTS & PLANS (3 BOOKS)	US \$3.49	AU \$6.19	1	08-Sep 07:32
	This is Your Georgia, Bernice McCullar	US \$6.00	AU \$10.65	-	08-Sep 07:33
	BIRTHDAY CAKES/KIDS Cookbook No Fancy Pans	US \$4.82	AU \$8.20	5	08-Sep 07:33
	ANGEL'S FOOD Church COOKBOOK Naples FL 1985	US \$8.30	AU \$14.73	7	08-Sep 07:33
	Sugar Busters!#1 NY Times Bestseller	US \$11.09	AU \$19.68	3	08-Sep 07:33
	Wyoming Territory by Jackie Merritt--Historic	US \$1.00	AU \$1.77	-	08-Sep 07:33
	KNOX GELATIN 6 vintage recipe leaflets. NR	US \$6.02	AU \$10.68	3	08-Sep 07:33
	Say you Love Me--Lindsey--Historical--PB--NR	US \$2.00	AU \$3.55	-	08-Sep 07:33

FIG. 14C



	1866 HISTORY OF THE UNITED STATES FROM AD 432	US \$15.50	AU \$27.51	2	08-Sep 07:33
	1954 THE HAPPY LION by Louise Fatio	US \$4.00	AU \$7.10	1	08-Sep 07:33
	HUGE Historical Reference Library on CD-ROM	US \$11.99	AU \$21.28	-	08-Sep 07:33
	HUGE Historical Reference Library on CD-ROM	US \$11.99	AU \$21.28	-	08-Sep 07:33
	Abraham Lincoln The Boy and The Man	US \$8.00	AU \$14.20	-	08-Sep 07:33
	'54-G. Meredith-"ORDEAL of RICHARD FEVEREL"-UK	US \$3.95	AU \$7.01	-	08-Sep 07:33
	HOMESCHOOLING UNIT STUDIES abhomeschool.com	US \$39.95	AU \$70.90	-	08-Sep 07:33
	LET'S GO TO THE MOON - 1977 NAT GEO. GRAPH	US \$3.99	AU \$7.08	-	08-Sep 07:34
	Apache Magic--Janis Hudson--Historical--PB--NH	US \$2.00	AU \$3.55	-	08-Sep 07:34
	WILL ROGERS by P.J. O'BRIEN WILEY POST 1935!!	US \$1.00	AU \$1.77	-	08-Sep 07:34
	1914 THE CAMP FIRE GIRLS ON THE MARCH	US \$1.00	AU \$1.77	-	08-Sep 07:34
	Book, 1929 Friends A Primer/Pennnell&Cusak	US \$4.24	AU \$7.53	2	08-Sep 07:34
	BADGER CLARK Signed SUN & SADDLE LEATHER	US \$21.87	AU \$38.46	6	08-Sep 07:34
	CHARLES BUKOWSKI "TRIGGER" T-SHIRT XL RARE!	US \$9.99	AU \$17.73	1	08-Sep 07:34
	1944 Operative oral surgery w/illustr	US \$9.99	AU \$17.73	1	08-Sep 07:34
	CHARLES BUKOWSKI T-SHIRT XL "DAMNED LIPS"	US \$9.99	AU \$17.73	-	08-Sep 07:34
	(audio) BEN BOVA - DEATH DREAM - SF 2 Cassett	US \$2.25	AU \$3.99	-	08-Sep 07:34

For more items in this category, click these pages:

= 1 = 2 3 4 5 6 ... 20 ... 40 ... 60 ... 80 ... 100 ... 120 ... 140 ... 160 ... 180 ... 200 ... 220 ... 240 ... 260 ... 280 ... 300 ... 320 ... 340 ... 360 ... 380 ... 400 ... 420 ... 440 ... 460 ... 480 ... 500 ... 520 ... 540 ... 560 ... 580 ... 600 ... 620 ... 640 ... 660 ... 680 ... 700 ... 720 ... 740 ... 760 ... 780 ... 800 ... 820 ... 840 ... 860 ... 880 ... 900 ... 920 ... 940 ... 960 ... 980 ... 1000 ... 1020 ... 1040 ... 1060 ... 1080 ... 1100 ... 1120 ... 1140 ... 1160 ... 1180 ... 1200 ... 1220 ... 1240 ... 1260 ... 1280 ... 1300 ... 1320 ... 1340 ... 1360 ... 1380 ... 1400 ... 1420 ... 1440 ... 1460 ... 1480 ... 1500 ... 1520 ... 1540 ... 1560 ... 1580 ... 1600 ... 1620 ... 1640 ... 1660 ... 1680 ... 1700 ... 1720 ... 1740 ... 1760 ... 1780 ... 1800 ... 1820 ... 1840 ... 1860 ... 1880 ... 1900 ... 1920 ... 1940 ... 1960 ... 1980 ... 2000 ... 2020 ... 2040 ... 2060 ... 2080 ... 2100 ... 2120 ... 2140 ... 2160 ... 2180 ... 2200 ... 2220 ... 2240 ... 2260 ... 2280 ... 2300 ... 2320 ... 2340 ... 2360 ... 2380 ... 2400 ... 2420 ... 2440 ... 2460 ... 2480 ... 2500 ... 2520 ... 2540 ... 2560 ... 2580 ... 2600 ... 2620 ... 2640 ... 2660 ... 2680 ... 2700 ... 2720 ... 2740 ... 2756 ... (next page)

FIG. 14D

262



Hot Items in Books

Current

You are on page 1 of 66. [Next Page](#) ▶

= Gallery = Picture = Hot!

Status	Item	Auction Price	Converted Amount*	Bids	Ends BST
	Principles of Instrumental Analysis, 4th ed.	US \$40.04	AU \$71.06	39	11-Sep 03:44
	Bible on Cassette--New Test--King James--\$1.00	US \$3.00	AU \$5.32	70	11-Sep 16:20

Click on a title to get a description and to bid on that item. A red ending time indicates that an auction is ending in less than five hours. These items are not verified by eBay; caveat emptor. This page is updated regularly; don't forget to use your browser's reload button for the latest version. The system may be unavailable during regularly scheduled maintenance - Please note the **regularly scheduled maintenance time is Fridays, 09:00 to 11:00 BST** (Fridays, 01:00 a.m. to 05:00 a.m., eBay time).

Updated: 06-Sep 7:30:05 EDST [Check eBay official time](#)
 Use your browser's reload button to see the latest version.

FIG. 14E

260

[Startseite](#) | [Mein eBay](#) | [Übersich](#) | [Einloggen](#)

Stöbern Verkaufen Service Suchen Hilfe Gemeinschaft

Alle Artikel Artikel aus der Galerie

Titel und Beschreibungen suchen

▽ Hier können Sie Ihre eigene [Meine Homepage](#) anlegen und bearbeiten.
 ▽ Lesen Sie mehr über [Was ist eBay?](#)

Tipps

Aktualisiert: 07. Sep. 22:30:05 MESZ Prüfen Sie Die offizielle eBay Zeit

eBay Kategorien

Aktuell || Heute neu || Endet heute || Last Minute (Auktion, die innerhalb von drei Stunden endet)

Artikel in DM	Artikel mit Standort in Deutschland	Artikel lieferbar nach Deutschland
Kunst & Antiquitäten (2778) Antiquariat (243) Bilder (1060) Gemälde (343) Glas & Kristall (70) Geräte (48) International (289) Keramik (87) Metallwaren (241) Mobiliar & Textilien (246) Porzellan (41) Poster & Kunstdrucke (10) Sammlerporzellan (8) Themen (92)	Foto, Audio & Video (1353) Elektronik (375) Foto (934) TV & Video (44)	Puppen, Teddies & Beanies (920) Beanies (425) Puppen (430) Steiff (8) Teddys (53) Sonstige Kuscheltiere (4)
Auto & Motorrad (155) Fahrzeuge (40) Teile, Tuning & Zubehör (31) Autovermietung (0) Oldtimer (7) Automobilia (40) Motorräder (32) Klassische Motorräder (2) Sonstige (3)	Freizeit, Haus & Service (4044) Wein & Champagner (20) Bar & Spirituosen (3) Nahrungsmittel & Spezialitäten (5) Gesundheit & Beauty (22) Lifestyle (18) Haus & Büro (271) Haushaltsgeräte (31) Heim- & Handwerker (403) Hobby (33) Interieur & Design (9) Garten (73) Tierwelt (12) Kleidung (2903) Baby (189) Reisen (4) Service (0) Veranstaltungskarten (48)	Telekommunikation (557) Handys (158) Handy Akkus (16) Handy Ladegeräte (23) PrePaid Karten & Verträge (46) Handyzubehör (293) Telefone Analog (3) Telefone ISDN (1) Telefone Schnurlos (7) Faxgeräte (0) Telefonanlagen (5) Sonstige (5)
Bücher, Film & Musik (15525) Bücher (2562) Zeitschriften (747) Film (1381) Musik (8306) Musikinstrumente (453)	Sammeln & Seltenes (3900) Comics (89) Figuren (52) Fantasy (203) Pokemon (40) Science Fiction (270) Sammeln & Seltenes (2938)	eBayPro (35) Computer (3) Telekommunikation (10) Profession, Dienstleistungen (0) TV, Video, Foto & HiFi (4) Rund ums Büro (0) Rund ums Haus (1) Textilien (0) Diverse Branchen/Aktionsware (9) Maschinenbau (1)

FIG. 15A



- Hörspiele (45)
- Fanartikel & Memorabilia (2031)
- Briefmarken & Münzen (1333)**
 - Deutsche Briefmarken (66)
 - Briefmarken Europa (128)
 - Briefmarken International (247)
 - Briefmarken Motive (279)
 - Briefmarken Sonstige (166)
 - Münzen Altertum (15)
 - Münzen Deutschland bis 1945 (5)
 - Münzen Deutschland ab 1945 (34)
 - Münzen Europa (113)
 - Münzen International (138)
 - Münzen Sonstige (1)
 - Papiergeld (69)
 - Historische Wertpapiere (71)
 - Patente & Rechte (0)
 - Finanzen (0)
 - Sonstige (1)
- Computer & Computerspiele (3206)**
 - Apple (123)
 - Bürobedarf (2)
 - Hardware (1391)
 - Klassische Computer (18)
 - Klassische Konsolen (73)
 - Literatur (59)
 - Notebooks (85)
 - PDAs & Organisier (109)
 - Software (540)
 - Spiele: Amiga (5)
 - Spiele: Apple (1)
 - Spiele: Internet (42)
 - Spiele: Nintendo (188)
 - Spiele: PC (274)
 - Spiele: Playstation (177)
 - Spiele: Sega (62)
 - Spiele: Merchandise (0)
 - Domainnamen (44)
 - Bannerwerbeplatz (6)
 - Sonstige (7)
- Ansichtskarten (308)
- Spielzeug & Modellbau (898)**
 - Modelleisenbahn (68)
 - Modelleisenbahn Spur HO (37)
 - Modellautos (574)
 - Modellbau (19)
 - RC-Modellbau (29)
 - Spielzeug (99)
 - Gesellschaftsspiele (71)
 - Sonstige (1)
- Sport (2482)**
 - Sportgeräte (432)
 - Fahrräder (44)
 - Wassersport (262)
 - Memorabilia (1090)
 - Trading Cards (654)
- Uhren & Schmuck (2364)**
 - Klassische Armbanduhren (414)
 - Trenduhren (12)
 - Swatch (53)
 - Sonstige Uhren (21)
 - Uhrenzubehör (21)
 - Warenartikel & Merchandising (1)
 - Klassischer Schmuck (1292)
 - Ringe (16)
 - Edelsteine (491)
 - Modeschmuck (41)
 - Sonstige (2)
- Baumaschinen (1)
- Elektrotechnik (0)
- Hotellerie & Gastronomie (2)
- Nutzfahrzeuge (0)
- Medizintechnik & Gesundheit (4)
- Landmaschinen (0)

Artikel

Endet innerhalb von fünf Stunden

= Galeria = Bild = Hot!

Klicken Sie auf einen Titel, um eine Beschreibung des Artikels zu erhalten und um auf den Artikel zu bieten. Der Verkäufer trägt die volle Verantwortung für das Anbieten dieses Artikels. Eine rote Endzeit gibt an, dass die Auktion innerhalb von fünf Stunden zu Ende geht. Bitte beachten Sie, dass das System unter Umständen

FIG. 15B

260



während der regulären Wartungszeit nicht zur Verfügung steht - diese Wartungszeiten sind Freitag, 10:00 bis 12:00 MESZ sind (eBay Deutschland Zeit).

Aktualisiert: 07. Sep. 22:30:05 MESZ Prüfen Sie die offizielle eBay Zeit
Verwenden Sie die Schaltfläche Aktualisieren/Erneut laden ihres Browsers, um die neueste Version zu sehen.

FIG. 15C

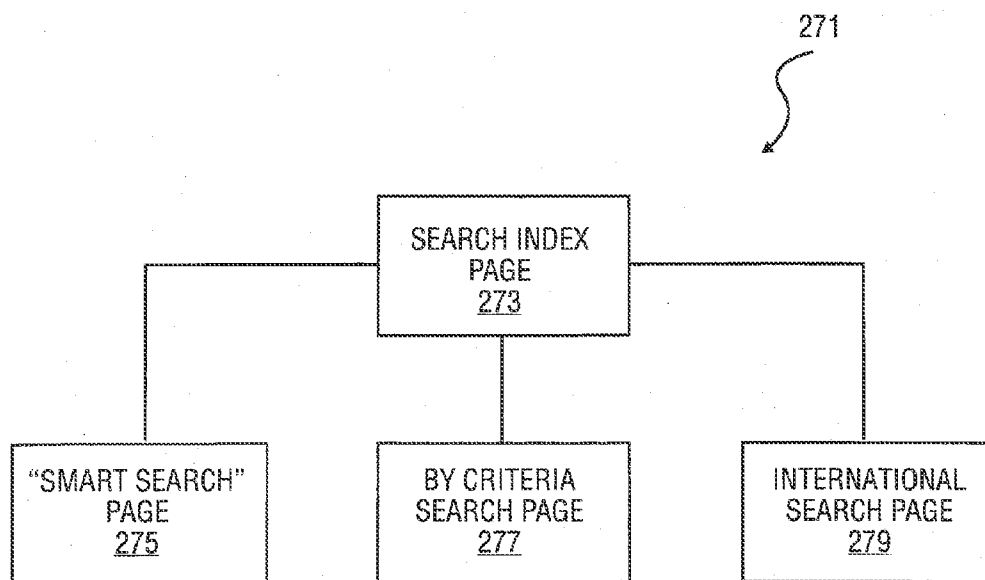

FIG. 16

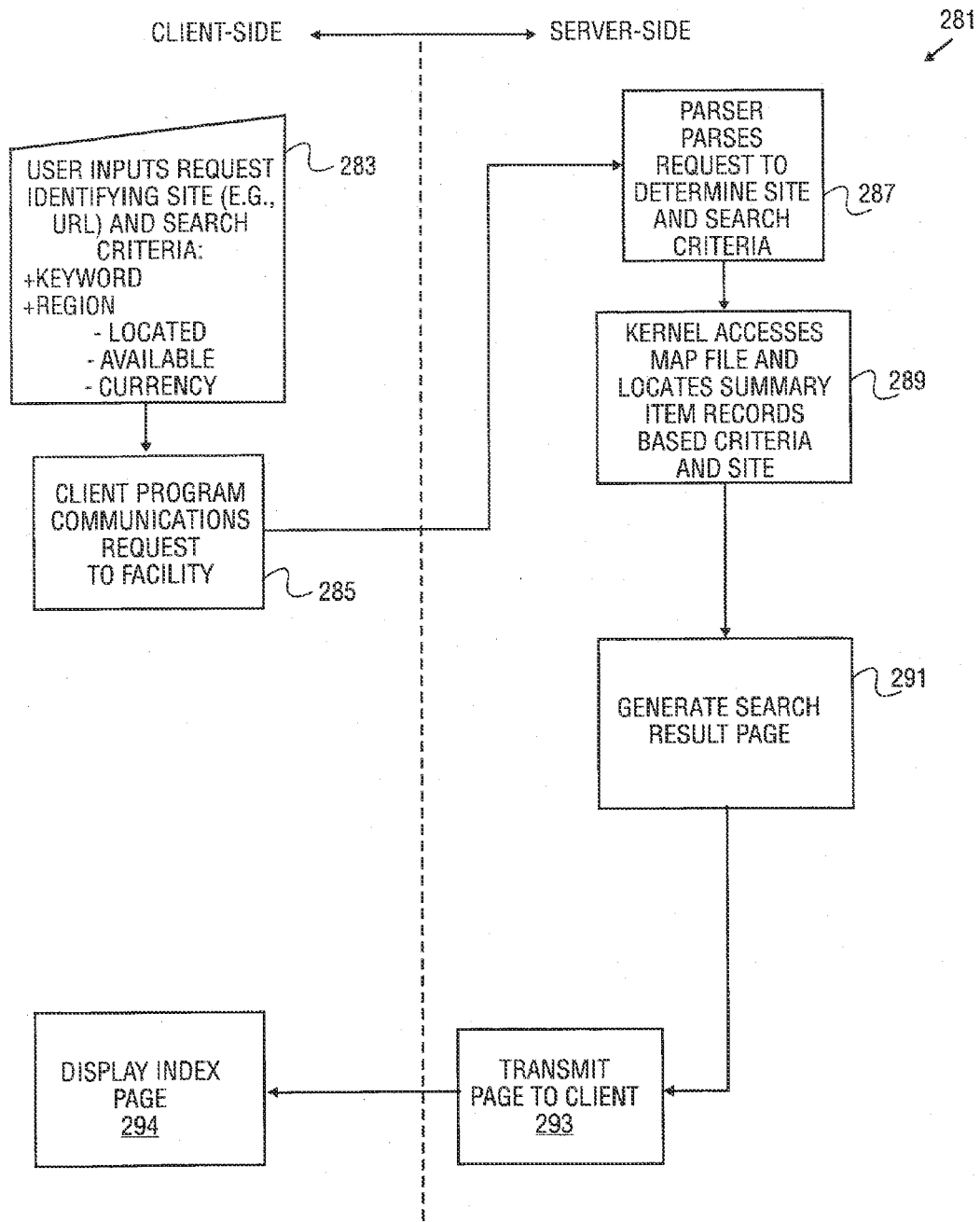

FIG. 17

296

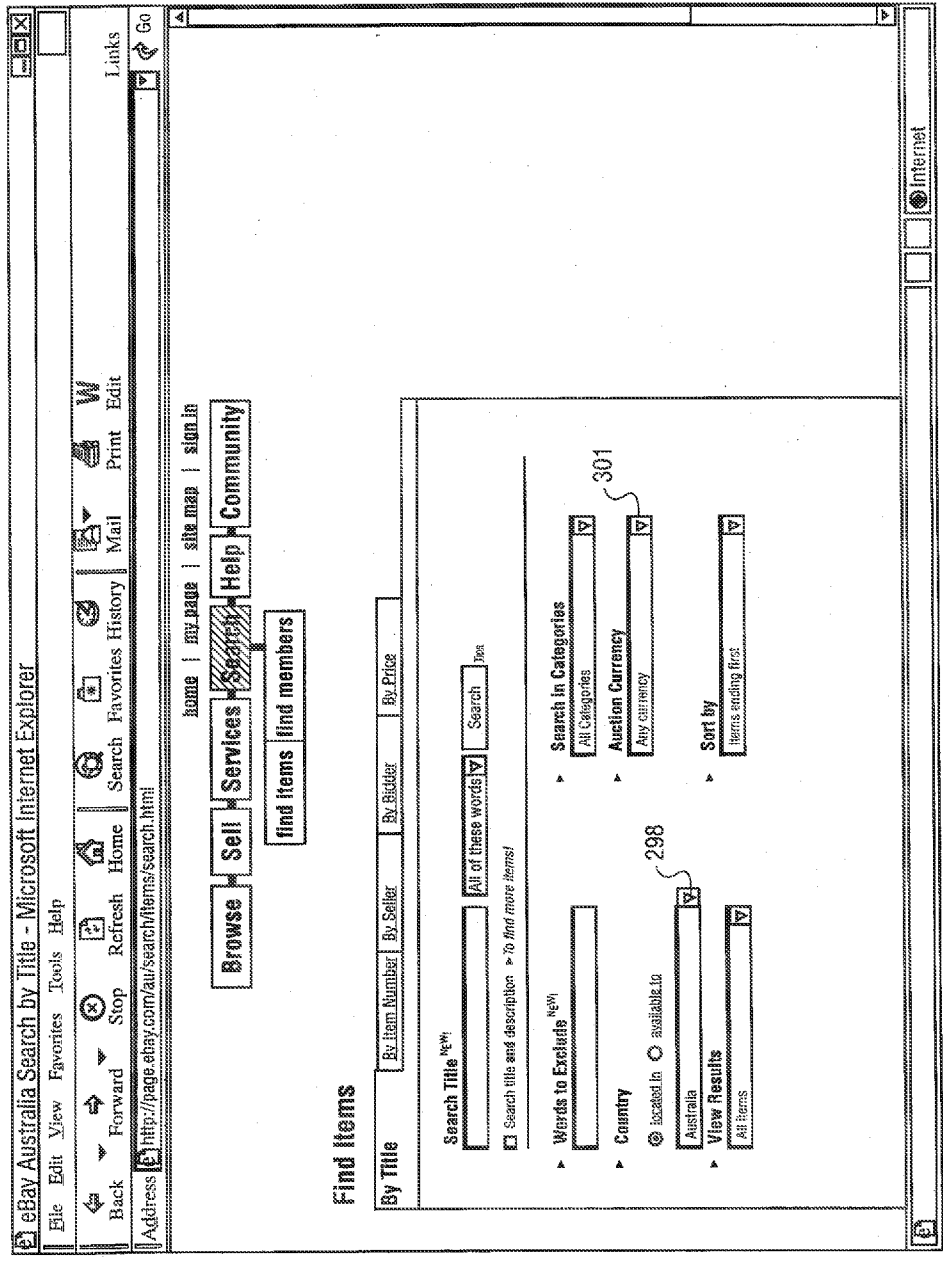

FIG. 18A

274

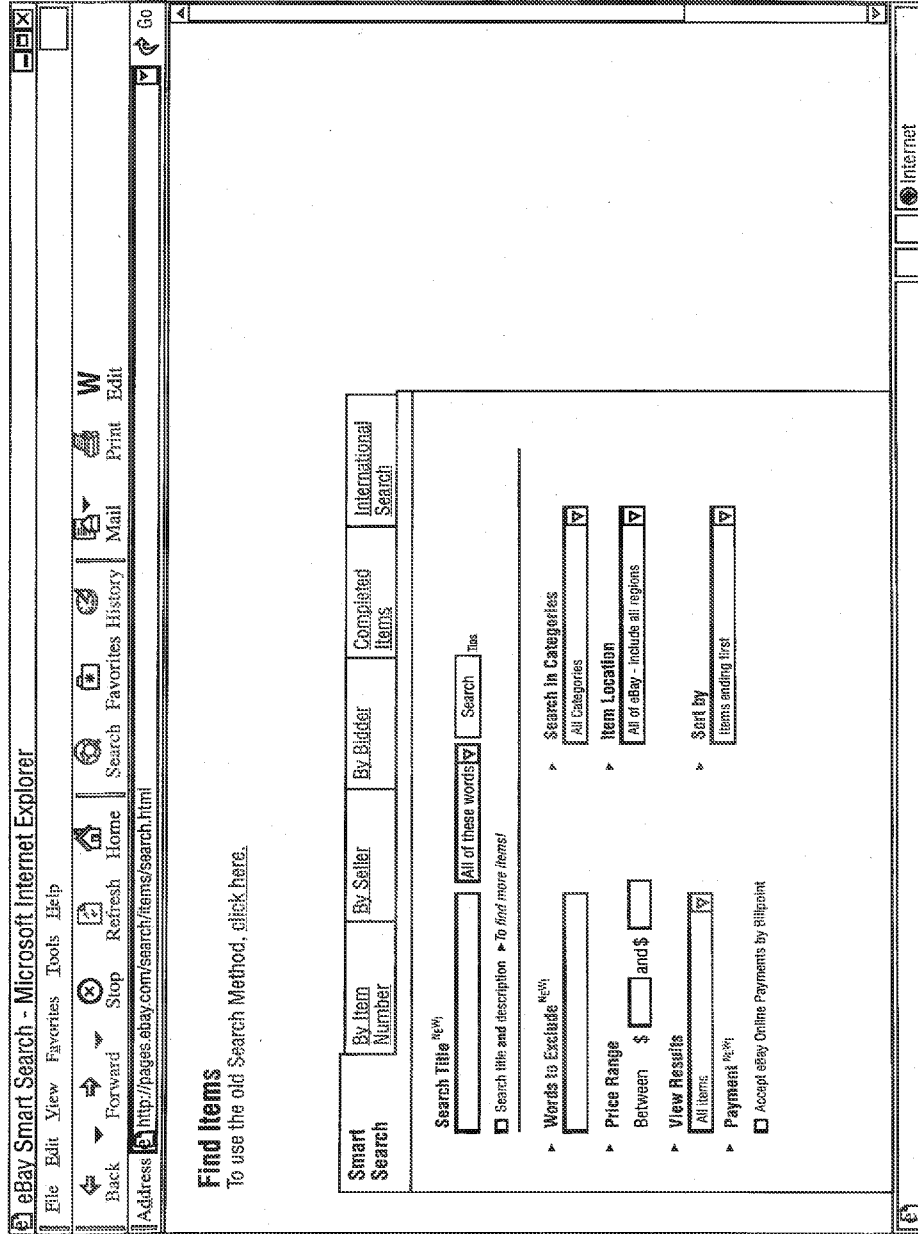

FIG. 18B

274

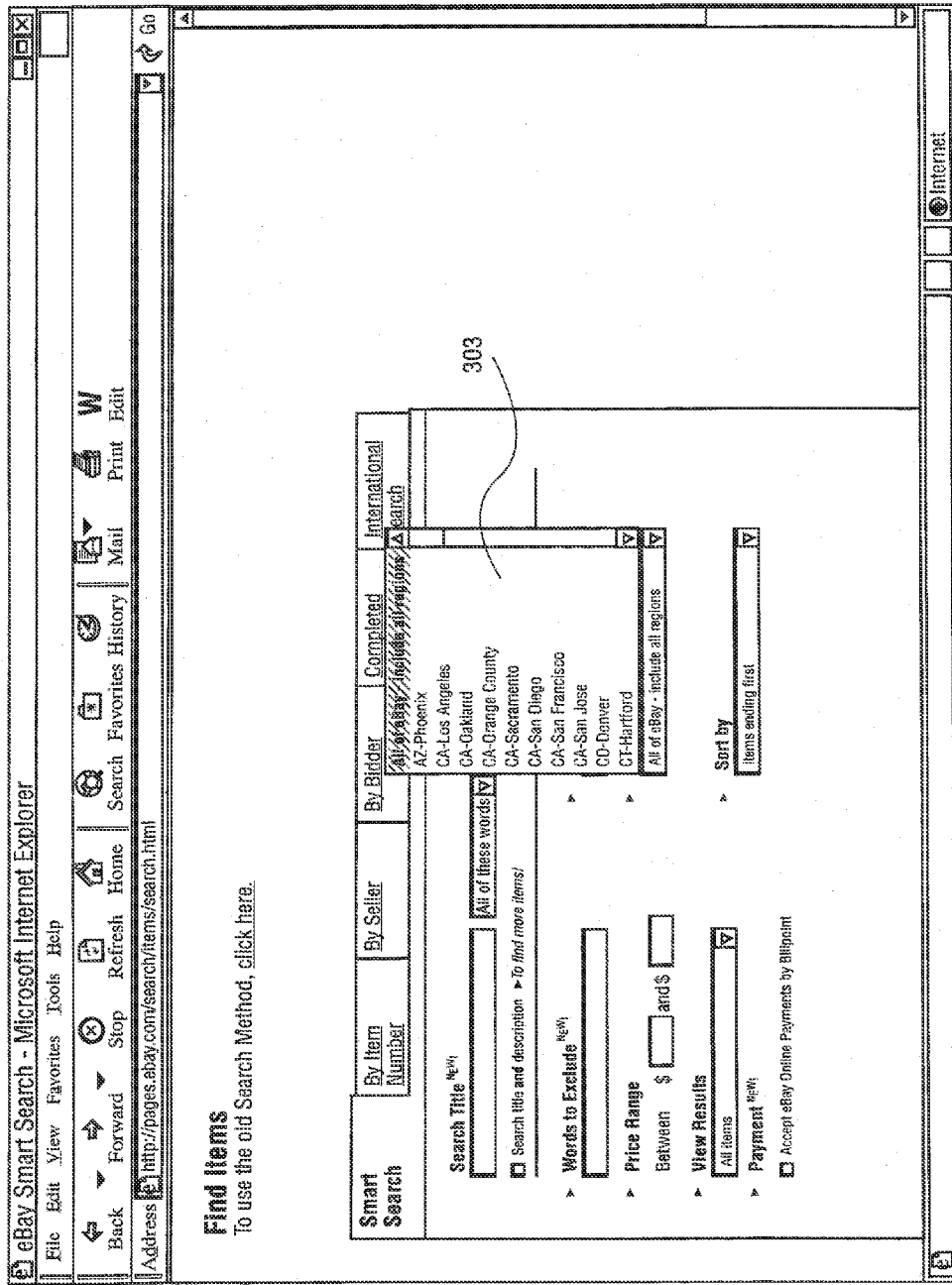

FIG. 18C

278

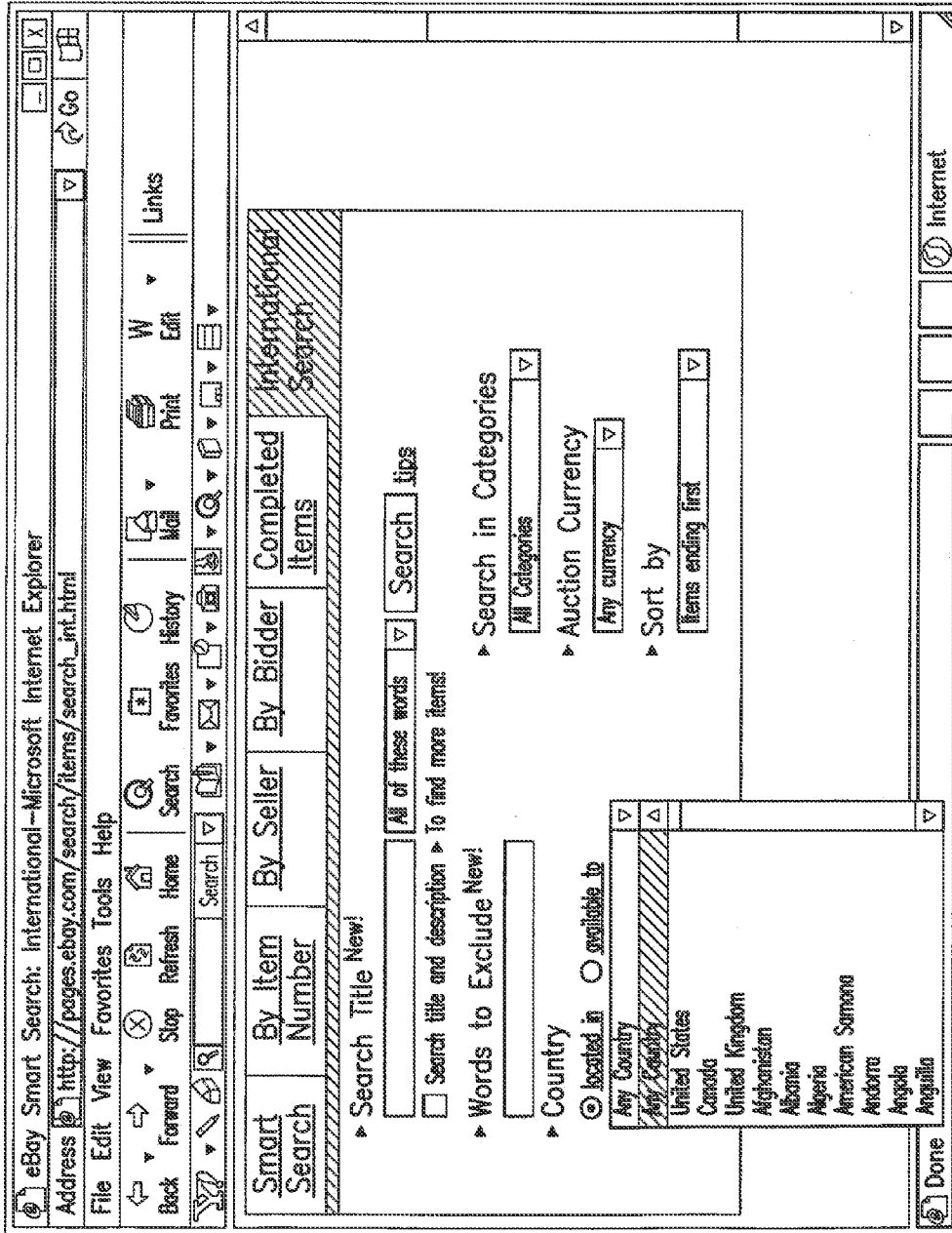

FIG. 18D

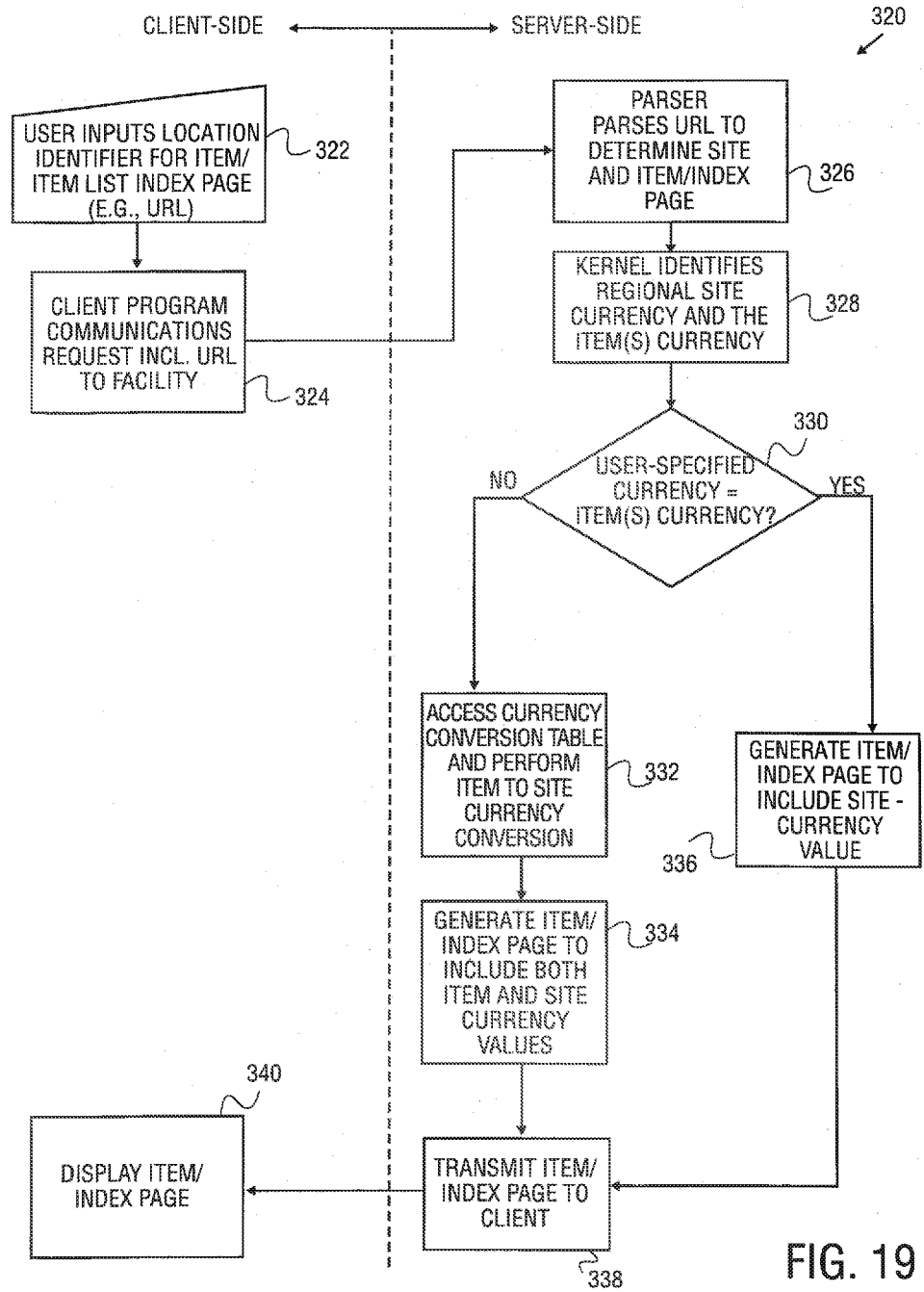

FIG. 19



[home](#) | [my page](#) | [site map](#)

Browse
Sell
Services
Search
Help
Community

Item view

Coin
Item #1041307

Coins & Stamps: Currency: World: Europe

 <small>Description</small>	Currently Quantity: 1 Time left: 6 days, 16 hours +	First bid: GBP 1.00 (approx. \$2.00) # of bids: 0 bid history with emails Location: London Country: United Kingdom
 <small>Bid</small>	Started: Sep-07-00 09:55:52 PDT Ends: Sep-14-00 09:55:52 PDT	mail this auction to a friend watch this item
	Seller (Rating): aman (4) 2 <small>(view comments in seller's Feedback Profile) (view seller's other auctions) (ask seller a question)</small>	
	High bid: -- Payment: Money Order/Cashiers Checks. Personal Checks. See item description for payment methods accepted	
	Shipping: Will ship to United Kingdom only. See item description for shipping charges Update item: Seller: If this item has received no bids, you may revise it.	

Seller assumes all responsibility for listing this item. You should contact the seller to resolve any questions before bidding. Auction currency is Pounds Sterling (GBP) unless otherwise noted.

Description

Coin

Bidding

Coin
Item #1041307

Opening bid:

Your maximum bid:

(Minimum bid: GBP 1.00)

eBay will bid incrementally on your behalf up to your maximum bid, which is kept secret from other eBay users. The eBay term for this is proxy bidding.

How to Bid 

1. [Register to bid](#) - If you haven't already. It's free!
2. [Learn about this seller](#) - read feedback comments left by others.
3. [Know the details](#) - the item description and payment & shipping terms closely.



FIG. 20A

[page d'accueil](#) | [mon eBay](#) | [plan du site](#) | [ouvrir session](#)

[Parcourir](#) | [Vendre](#) | [Services](#) | [Rechercher](#) | [Aide](#) | [Village](#)
[voir article](#)

SGSGSG
Article n°1041307

Coins & Stamps:Currency: World:Europe

	Actuellement	1,00 GBP (environ 14 FF)	Première enchère	1,00 GBP (environ 14 FF)
	Quantité	1	Nb d'enchères	0 historique de l'enchère avec emails
Description	Temps restant	6 jours, 16 heures +	Emplacement	sgsgsgsg
	A commencé le	Sep-07-00 09:55:52 Paris	Pays	Royaume-Uni
	Se termine le	Sep-14-00 09:55:52 Paris	<input type="checkbox"/> envoyez cette enchère à un ami	<input type="checkbox"/> suivre cet article
Bid	Vendeur (Evaluation)	zuman (4) afficher les commentaires dans le profil d'évaluation du vendeur afficher les autres enchères du vendeur poser une question au vendeur		
	Enchère la plus haute	--		
	Paiement	Mandat ou chèques tirés, Chèque bancaire, Pour les méthodes de paiement, veuillez consulter la description de l'article		
	Expédition	Destination de l'expédition : Royaume-Uni uniquement. Pour les frais d'expédition, veuillez consulter la description de l'article		
	Mise à jour de l'article	Vendeur: Si cet article n'a pas reç d'enchères, vous pouvez le modifier .		

Le vendeur assume l'entière responsabilité de la mise en vente de cet article. Si vous avez des questions, veuillez le contacter avant d'enchérir. La devise de la vente aux enchères est Livres Anglais (GBP) à moins de la mention du contraire.

Description

sgsgsgsgs

Enchérir

sgsgsg
Article n°1041307

Enchère départ : **1,00 GBP**

Votre enchère maximale :

(Mise à prix : 1,00 GBP)

Comment enchérir? 

1. **Inscrivez-vous pour enchérir** si ce n'est pas déjà fait. C'est gratuit!
2. **Au sujet de ce vendeur** - lisez le profil d'évaluation établi par d'autres utilisateurs.

FIG. 20B

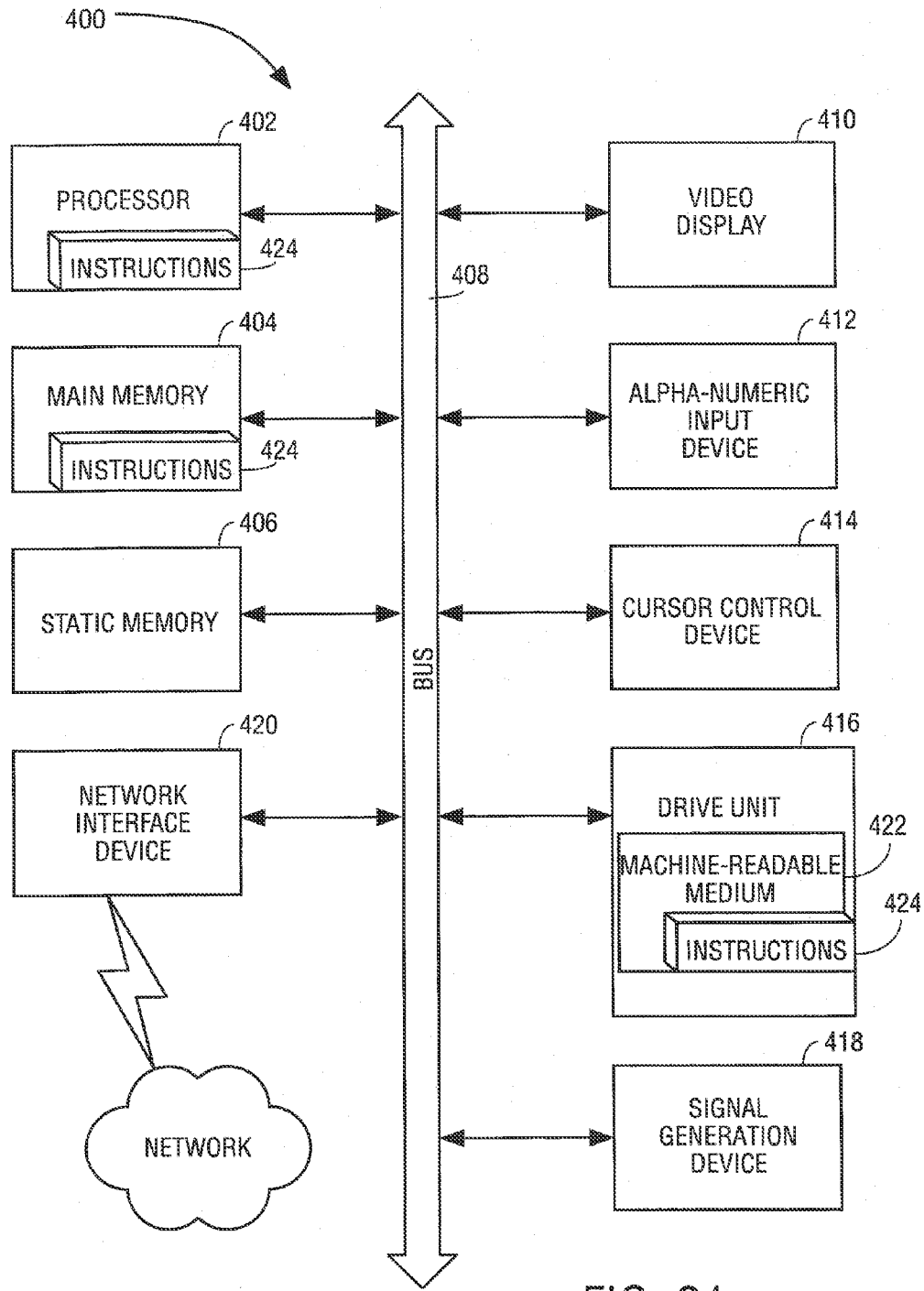

FIG. 21

**METHOD AND SYSTEM FOR LISTING
ITEMS GLOBALLY AND REGIONALLY, AND
CUSTOMIZED LISTING ACCORDING TO
CURRENCY OR SHIPPING AREA**

RELATED APPLICATIONS

[0001] The present application is a continuation of U.S. patent application Ser. No. 13/550,233, filed Jul. 16, 2012, which is a continuation of U.S. patent application Ser. No. 12/693,275, filed Jan. 25, 2010 (Issued as U.S. Pat. No. 8,266,016 on Sep. 11, 2012), which is a continuation of U.S. patent application Ser. No. 09/905,525 filed Jul. 13, 2001 (Issued as U.S. Pat. No. 7,660,740 on Feb. 9, 2010), which claims priority from U.S. Provisional Patent Application Ser. No. 60/241,081 filed Oct. 16, 2000, the benefit of priority of each of which is claimed hereby, and each of which are incorporated by reference herein in their entirety.

FIELD OF THE INVENTION

[0002] The present invention relates generally to the field of Internet-based commerce and, more specifically, to a method of facilitating electronic commerce (e.g., the auction of goods and/or services) in a regional manner.

BACKGROUND OF THE INVENTION

[0003] Electronic commerce a.k.a., e-commerce technology holds the promise of introducing efficiencies into marketplace and trading activities by automating many trading activities, providing near real-time information to both buyers and sellers and providing convenient channels between buyers and sellers. The ubiquity of the Internet, in particular, has led to the widespread utilization of this technology as a platform for the conducting of electronic commerce and for providing global on-line marketplaces. The increasing globalization of business and trading, no doubt facilitated by the Internet, has exposed a number geographic and regional challenges to electronic commerce. For example, the automated functionality provided by an electronic commerce facility may be unsuitable for global deployment for language, cultural and other reasons.

SUMMARY OF THE INVENTION

[0004] According to the present invention, a method to facilitate network-based commerce includes determining a site that a user accesses, the site being one of multiple sites operated by a network-based commerce facility. A category list available for the site is retrieved, the category list identifying categories of offerings available via the site. The category list is communicated to the user. The site is a regional site, and the category list is a region-specific category list.

BRIEF DESCRIPTION OF THE DRAWINGS

[0005] The present invention is illustrated by way of example and not limitation in the figures of the accompanying drawings, in which like references indicate similar elements and in which:

[0006] FIG. 1 is a block diagram illustrating an exemplary network-based commerce facility, in the form of an Internet-auction facility.

[0007] FIG. 2 is a database diagram illustrating an exemplary database maintained and accessed via a database engine server that supports the auction facility.

[0008] FIG. 3A illustrates an exemplary embodiment of an “items” table within a database maintained by the exemplary auction facility.

[0009] FIG. 3B illustrates an exemplary embodiment of a “master categories” table maintained by the exemplary auction facility.

[0010] FIG. 3C illustrates an exemplary embodiment of a “site categories” table maintained by the exemplary auction facility.

[0011] FIG. 4 illustrates an exemplary embodiment of a code system that includes software modules.

[0012] FIG. 5 is a diagrammatic representation, according to an exemplary embodiment of the present invention, of the generation of a map file by a listings module utilizing information contained in the items table.

[0013] FIG. 6 is a diagrammatic representation of case logic implemented by the listings module, according to an exemplary embodiment of the present invention.

[0014] FIG. 7 is a diagrammatic representation of a map file, according to an exemplary embodiment of the present invention.

[0015] FIG. 8 is a flow chart illustrating a method, according to an exemplary embodiment of the present invention, of generating a map file.

[0016] FIG. 9 is a diagrammatic representation illustrating further details of an exemplary implementation of a map file.

[0017] FIG. 10 is a page diagram illustrating an exemplary page map that constitutes part of a regional or community site supported by a network-based commerce facility.

[0018] FIG. 11 is a flow chart illustrating a method, according to an exemplary embodiment of the present invention, of generating and communicating information concerning a hierarchical category data structure to a user.

[0019] FIGS. 12A-12D, 13A-13D, and 14A-14E illustrate examples of item list index pages generated by a plurality of different regional sites.

[0020] FIGS. 15A-15C illustrate a category browse index page, according to an exemplary embodiment of the present invention, for a German site operated by a network-based commerce facility.

[0021] FIG. 16 is a page map, according to an exemplary embodiment of the present invention, that may be accessible via a search index page.

[0022] FIG. 17 is a flow chart illustrating a method, according to an exemplary embodiment of the present invention, of facilitating a search of offerings of a network-based commerce facility.

[0023] FIGS. 18A-18D illustrate exemplary web page interfaces generated by a server and communicated to a client machine, the web pages facilitating the input of search criteria.

[0024] FIG. 19 is a flow chart illustrating a method, according to an exemplary embodiment of the present invention, of performing a currency conversion for offerings presented via a network-based commerce facility.

[0025] FIGS. 20A-20B illustrate exemplary item pages for an item originally listed in pounds, but where the item pages are retrieved via U.S. and French sites, respectively.

[0026] FIG. 21 presents a diagrammatic representation of a machine in the exemplary form of a computer system within which a set of instructions, for causing the machine to perform any one of the methodologies discussed above, may be executed.

DETAILED DESCRIPTION

[0027] In the following description, for purposes of explanation, numerous specific details are set forth in order to provide a thorough understanding of the present invention. It will be evident, however, to one skilled in the art that the present invention may be practiced without these specific details.

[0028] In general, embodiments described below feature a network-based commerce facility that allows a user of the system to bid on offerings (e.g., products or services) that are for sale by sellers. A preferred embodiment of the present invention features a network-based application for online auctions.

[0029] In one embodiment, the present invention is implemented as a network-based service that may be accessed through, for example, the Internet using a Web browser. According to a first aspect of the present invention, the service provides an interface that allows a user to browse through the offerings that are available in his/her country of location and bid on a particular offering. According to a second aspect of the present invention, the service provides geographically customized information and interfaces to a user of the service.

Internet-Related Technology

[0030] As indicated above, one embodiment of the present invention provides an Internet-based implementation. Accordingly, some introduction to Internet-related technology is helpful in understanding the present invention. The Internet is a vast and expanding network of computers and other devices linked together by various telecommunications media, enabling the various components to exchange and share data. Sites (so-called Web sites), accessible through Internet, provide information about numerous corporations and products, as well as education, research, entertainment and services.

[0031] A resource that is attached to the Internet is often referred to as a “host.” Examples of such resources include conventional computer systems that are made up of one or more processors, associated memory and other storage devices and peripherals, such as modems, networks interfaces and the like that allow for connection to the Internet or other networks. In most cases, the hosting resource may be embodied as hardware and/or software components of a server or other computer system that includes an interface module, which allows for some dialog with users and that may process information through the submission of Web forms completed by the user. Generally, such a server will be accessed through the Internet’s graphical user interface, the World Wide Web, (e.g., via Web browsers) in the conventional fashion.

[0032] In order to facilitate communications between hosts, each host has a numerical Internet Protocol (IP) address. The IP address of a hypothetical host computer might be 112.222.64.27. Each host also has a unique “fully qualified domain name.” In the case of the hypothetical host 112.222.64.27, the “fully qualified domain name” might be “computer.domain.com.”, the three elements of which are the hostname (“computer”), a domain name (“domain”) and a top-level domain (“com”). A given host looks up the IP address of other hosts on the Internet through a system known as domain name service.

[0033] As previously indicated, in order to access the Internet most users rely on computer programs known as “Web

browsers.” Commercially available Web browsers include such well-known programs as Netscape’s Navigator™ and Communicator™ and Microsoft’s Internet Explorer™. If an Internet user desires to establish a connection with a Web page hosted at computer.domain.com, the Internet user might enter into a Web browser program the uniform resource locator (URL) “http://www.domain.com”. The first element of the URL is a transfer protocol, most commonly “http” standing for hypertext transfer protocol, but others include “mailto” for electronic mail, “ftp” for file transfer protocol, and “nntp” for network news transfer protocol. The remaining elements of this URL are an alias for the fully qualified domain name of the host.

[0034] Once a URL is entered into the browser, the corresponding IP address is looked up in a process facilitated by a server computer, called the top-level server. The top-level server matches the domain name to an IP address of a domain name server capable of directing the inquiry to the computer hosting the Web page. Thus, the domain name server ultimately matches an alphanumeric name such as www.domain.com with its numeric IP address 112.222.64.27.

[0035] When a host receives an inquiry from the Internet, it returns the data in the file pointed to by the request to the computer making the inquiry. Such data may make up a Web page, which may include a textual message, sound, picture, or a combination of such elements. A user can move between Web pages through the use of hyperlinks, which are links from one site on the Internet to another.

[0036] A component of one embodiment of the present invention is a computer server. Servers are computer programs that provide some service to other programs, called clients. A client and server communicate by means of message passing often over a network, and use some protocol, a set of formal rules describing how to transmit data, to encode the client’s requests and/or responses and the server’s responses and/or requests. The server may run continually waiting for client’s requests and/or responses to arrive or it may be invoked by some higher-level continually running server, which controls a number of specific servers. Client-server communication is analogous to a customer (client) sending an order (request) on an order form to a supplier (server) dispatching the goods and an invoice (response). The order form and invoice are part of the protocol used to communicate in this case.

[0037] Yet another component of one embodiment of the present invention is cache. Cache is a temporary storage area for frequently accessed or recently accessed data. There are two kinds of cache: internal (or memory cache) and external (or disk cache). Internal cache is built into a CPU, and external cache is located on a motherboard. When data is downloaded from a web page, the data is “cached” (i.e., temporarily stored on a computer). The next time the web page is accessed, instead of requesting a file from a Web server, a Web browser accesses it from the cache, so the page loads quickly.

[0038] Another component of the one embodiment of the present invention is Internet Server Application Program Interface (ISAPI), which is an application program interface for Internal Information Server (IIS) Web Server produced by Microsoft Corporation of Redmond, Wash. ISAPI enables programmers to develop Web-based applications that run much faster than conventional Common Gateway Interface (CGI) programs because they are more tightly integrated with the Web server.

Architecture

[0039] With these concepts in mind, an exemplary embodiment of a system architecture of the present invention can be explored. FIG. 1 is a block diagram illustrating an exemplary network-based commerce facility in the form of an Internet-based auction facility 10. While an exemplary embodiment of the present invention is described within the context of an auction facility, it will be appreciated by those skilled in the art that the invention will find application in many different types of computer-based, and network-based, commerce facilities.

[0040] The term “offering” is used below to designate any offering by a seller to a buyer, and this term should be understood to include, but not be limited to, any product or service offering.

[0041] For the purposes of the present specification, the term “site” shall be taken to comprise a collection of linked resources that may be accessed via a network. For example, a site may be represented on the World Wide Web (WWW), and include a collection of web pages (e.g., markup language documents) that may be static, store documents, or dynamically generated documents, between which links exist. The resources that constitute the site may furthermore be any documents, files, applications, application components or the like. A site may, for example, be owned or managed by an individual, a company or organization. Within the context of the WWW, a web site typically is characterized in that all resources of the web site are addressed utilizing a common domain (e.g., www.ebay.com or www.ebay.co.uk).

[0042] For the purpose of the present specification, the term “region” shall be taken to include any geographically identifiable area, demarcated according to political, economic, cultural, social or other criteria. The term “community” shall similarly be taken to include any grouping of people, defined according to social, political, economic, cultural, geographic or other criteria.

[0043] Referring to FIG. 1, the auction facility 10 includes one or more of a number of types of front-end servers, namely communications servers in the exemplary form of page servers 12 that deliver web pages (e.g., markup language documents), picture servers 14 that dynamically deliver images to be displayed within Web pages, listing servers 16, processing servers in the exemplary form of CGI (or ISAPI) servers 18 that provide an intelligent interface to back-end servers, and search servers 20 that handle search requests to the facility 10. E-mail servers 21 provide, inter alia, automated e-mail communications to users of the facility 10.

[0044] The back-end servers include a database engine server 22, a search index server 24 and a credit card database server 26, each of which maintains and facilitates access to a respective database.

[0045] The Internet-based auction facility 10 may be accessed by a client program 30, such as browser (e.g., the Internet Explorer distributed by Microsoft Corp. of Redmond, Wash.) that executes on a client machine 32 (e.g., a personal computer, PDA, cell phone or the like) and accesses the facility 10 via a network 34 such as, for example, the Internet. Other examples of networks that a client may utilize to access the auction facility 10 include a wide area network (WAN), a local area network (LAN), a wireless network (e.g., cellular network), or the Plain Old Telephone Service (POTS) network.

[0046] FIG. 2 is a database diagram illustrating an exemplary database 23, maintained by and accessed via the data-

base engine server 22, which at least partially implements and supports the auction facility 10. The database 23 may, in one embodiment, be implemented as a relational database, and includes a number of tables having entries, or records, that are linked by indices and keys. In an alternative embodiment, the database 23 may be implemented as collection of objects in an object-oriented database.

[0047] Central to the database 23 is a user table 40, which contains a record for each user of the auction facility 10. A user may operate as a seller, buyer, or both, within the auction facility 10. The database 23 also includes an items table 42 that may be linked to the user table 40. A user record in the user table 40 may be linked to multiple items that are being, or have been, auctioned via the facility 10.

[0048] The database 23 also include a note table 48 populated with note records that may be linked to one or more item records within the items table 42 and/or to one or more user records within the user table 40. Each note record within the table 48 may include, inter alia, a comment, description, history or other information pertaining to an item being auctioned via the auction facility 10, or to a user of the auction facility 10.

[0049] A number of other tables are also shown to be linked to the user table 40, namely a user past aliases table 50, a feedback table 52, a feedback details table 53, a bids table 54, an accounts table 56, and an account balances table 58.

[0050] The database 23 is also shown to include two tables specifically to enable an exemplary embodiment of the present invention. A master categories table 60 stores records for all the item categories presented across multiple, regional or community views (or presentations) of item categories via regional or community sites presented by the facility 10 throughout the world. A site categories table 62 stores records indicating which item categories are to be presented for respective regional or community sites, (e.g., a country, region or city specific site) presented by the facility 10. In other words, the master categories table 60 stores records for each category of a global collection of categories, and the site categories table 62 stores records indicating which of the global collection of categories are to be presented by each of a number of regional sites, along which information pertaining to the customized presentation of each category in a region-specific manner (e.g., a regional description, currency, language etc.).

[0051] FIG. 3A illustrates an exemplary embodiment of the items table 42. An Id field stores a numerical identification number for each item available via the auction facility 10. A sale type field contains information about acceptable payment options such as check, cash, and credit cards. The next field, title field, stores a descriptive title of the item to be displayed to the user of the auction facility 10. A location field contains information about a geographic location of the item, i.e. country, region, and specific address. This geographic location information may, in one embodiment, be a geographic location at which a seller of the item resides or may alternatively be information specified by the seller as the geographic location of the actual item. The information about which category the item belongs to is stored in a category field. For example, an item Barbie™ doll may belong to Toys category. Fields such as billing_currency, shipping_option, ship_region, description_language, site_id include information that depends on the location of the seller of the item or of the item itself, or the willingness of the owner of the item to ship the item to another geographic location or region. For

example, the billing currency for a particular item may be derived from the currency utilized at a geographic location (e.g., a country) in which the seller resides. Alternatively, the seller of the item may specify a particular currency in which the seller wishes to receive payment.

[0052] The shipping option information is typically inputted by seller, and indicates one or more shipping options (e.g., mail, courier-same day, courier-next day) specified by the seller.

[0053] The ship_region information may be inputted by a seller to indicate one or more geographic regions to which the seller is willing to ship the item or, in the case of services, to perform a particular service.

[0054] The description language information may be, as a default condition, populated with a predominate language in a geographic region or location in which the seller resides. For example, a seller located in the US may, as a default condition, have a description language indicated as English. A seller located in Germany would have German indicated as a default description language. In one embodiment, the seller may also specify an alternative description language to override a default condition. For example, a seller located in Japan may wish to specify that the description language is English in order to have the description of the relevant item available to a broader worldwide audience.

[0055] Site_id information identifies a geographically specific, or regional, site, presented by the auction facility 10, via which the seller offered the item for sale. For example, a Japanese seller may have placed an item up for auction via a Japanese site, presented by the auction facility 10, in which case the site_id information identifies the Japanese site.

[0056] It will be appreciated by one skilled in the art that the tables may have additional fields and are not limited to the above-described fields.

[0057] FIG. 38 illustrates an exemplary embodiment of the master categories table 60. A category_id field contains a unique numeric identifier of a category and name field stores a descriptive name of the category that is displayed to the user using the auction facility 10. A description field of the table 60 contains descriptive information about the category. Parent_id and parent_name fields are used in locating a particular category in a tree data structure (e.g., a tree hierarchy) order when displaying categories to the user. It will be appreciated that the above-described fields are an exemplary embodiment and other fields may be incorporated into the master categories table.

[0058] FIG. 3C illustrates an exemplary embodiment of the site categories table 62. The table 62 stores category information relevant to each of multiple regional (or geographically-specific) sites presented by the auction facility 10. One of the fields in the table is a site_id field, which stores a unique numeric identifier that is assigned to each of multiple regional or community sites. Category_id field stores a numeric identifier for a category that keys the relevant record to a category record within the master categories table 60. Name and description fields store a regional or community name of the category and description of the category. Parent_id and parent_name fields are used in placing a particular category in a free data structure (e.g., a tree hierarchy) when displayed to the user of the auction facility 10. Fields such as currency and language are region specific and store information that facilitates displaying to the user information in the specified language and in the currency of the site. It will be appreciated

that the above-described fields are an exemplary embodiment and other fields may be incorporated into the site categories table.

[0059] FIG. 4 illustrates an exemplary embodiment of a code system that contains some of the necessary modules that relate to the present invention. A kernel 100 is responsible for, inter alia, (1) determining which site the user entered and for (2) caching site categories in a site categories cache 150, ensuring higher performance by eliminating redundant accesses to the database 23 in which the tables 60 and 62 are stored. A category tree 160 stores categories in a tree data structure. A batch job module 140 is responsible for displaying initial web pages to a user of the auction facility 10. A search module 130 is responsible for performing searches through the item space, i.e. categories, when requested by the user. In one embodiment of the present invention, listings module 120 ensures that items that are displayed to the user are the ones that are available for shipping (or performance) in a region in which a user is located or that a user has specified. Another module that is present in the system is an ISAPI module 110. Category tree update module 180, which is part of the kernel 100, is a piece of code that is responsible for constructing the category tree 160 in order to ensure that the categories are displayed in a correct hierarchical relationship to the user of the auction facility 10. Parser 170 is a module that determines which site the user has entered. View module 190 generates the user-requested items and for display to a user (e.g., via a Web browser). Currency conversion module 195 is responsible for converting a price in listing currency into a regional (or native) currency for a particular site.

Map File

[0060] In order to increase the performance efficiencies of the facility 10, according to one embodiment of the present invention, a map file 200 is generated by the listings module 120, the map file 200 including summarized item records for each of the complete item records maintained in the items table 42. Furthermore, the summarized item records within the map file 200 are pre-categorized, or grouped, so as to facilitate improved responses to queries against the map file 200. The grouping of summary item records is conveniently labeled as views 210, which may be retrieved with minimal processing for display to a user. The summary item records constituting the map file 200 may include limited information, such as an item identifier, a title, a currency, and a data value, for example. The map file 200 may be utilized to facilitate browsing of items that are actively being auctioned by the facility 10, wherein the facilitating of the browsing requires only limited information regarding each item.

[0061] FIG. 5 is a diagrammatic representation, according to an exemplary embodiment of the present invention, of the generation of the map file 200 by the listings module 120 utilizing information contained in the items table 42. For example, the listings module 120 may comprise a Dynamic Link Library (DLL) that is utilized periodically to generate a fresh map file 200 from the full item records of the items table 42. It will be appreciated that the frequency with which the map file 200 is regenerated may vary depending on the frequency with which records are added to the items table 42. For example, in a heavily trafficked and active facility 10, the frequency with which map file 200 requires regeneration by the listings module 120 will be more frequent than for a facility 10 that is less active.

[0062] FIG. 6 is a diagrammatic representation of case logic implemented by the listings module 120, according to an exemplary embodiment of the present invention. Specifically, the listings module 120 is shown to implement three case statements, namely a “currency” case statement 202, a “region” case statement 204 and an “available” case statement 206. As will be described in further detail below, each of the case statements 202, 204 and 206 operates to generate a distinct view 210 of summary item records for each of multiple categories listed in the master categories table 60.

[0063] FIG. 7 is a diagrammatic representation of a map file 200, according to an exemplary embodiment of the present invention. Specifically, the map file 200 is shown to include an index 208 to multiple views of summary item records (e.g., within each category defined within the master categories table 60). In one embodiment, the map file 200 comprises a binary file. In summary, the map file 200 may be regarded as presenting a pre-organized (or grouped) summarization of information contained in the items table 42 that is maintained in memory of a computer system to provide performance advantages for browsing and searching operations.

[0064] FIG. 8 is a flow chart illustrating a method 220, according to an exemplary embodiment of the present invention, of generating the map file 200. At block 222, the listings module 120 accesses the items table 42 and, at block 224, identifies item records for items within a particular category N (e.g., category 0). Having then identified such item records, at block 226, the “currency” case statement 202 is applied against the item records identified at block 224 to generate a “currency” view 210A. Specifically, the listing module, for each of a pre-defined collection of currencies, determines if the currency information for each item record matches a respective pre-defined currency. For example, a first application of the case statement 202 at block 226 may determine whether the currency for each item record identified at block 224 is Australian dollars. Further, at block 226, the case statement 202 is applied to determine whether description language information for each of the relevant item records matches a predefined language, or set of languages, associated with the predefined currency. For example, a determination made during a first application of the case statement 202 may be made as to whether the description information language information indicates the English language. Assuming both the currency and description language comparisons are positive, then selected information from the relevant item record is included within the “currency” view 21A for the relevant currency. For example, a first application of the case statement 202 at block 226 may generate a view constituting summarized item records for all items being actively auctioned via the facility 10 for which the price is specified in Australian dollars, and the description language is English.

[0065] It will be appreciated that the case statement 202 will be applied for each of the predefined set of currencies to thereby generate a respective “currency” view 21A for each of the predefined set of currencies.

[0066] Similarly, at block 228, the “region” case statement 204 is applied against the item records retrieved at block 224 for each of a predefined set of regions, so as to generate a respective “region” view 210B for each of the set of regions. Specifically, location information from each of the item records is compared against a respective region of the predefined set of regions, and language description information is similarly compared against one or more languages associated with each of the regions to determine whether a summary

item record, derived from the full item record, should be included within the relevant “region” view 210B. The predefined set of regions may specify regions with any resolution, ranging, for example, from a suburb of a city to a continent or broader geographically identifiable area. For example, a region could comprise a town, a city, a metropolitan area, a county, a state, a county or a continent.

[0067] Further, as noted above with respect to FIG. 3A, the location information within each item record of the items table 42 may be the indicated location of a seller of the item. This information may or may not be important to a buyer, depending on the nature of the item. For example, where the item is a motor vehicle, clearly the location of the seller, and therefore probably the item, is important to a buyer in that the buyer may be more inclined to purchase a motor vehicle from a local seller. On the other hand, should the item be easily shipped (e.g., a stamp), the location of the seller may be of less consequence.

[0068] Returning to the method 220 illustrated in FIG. 8, at block 230, the listings module 120 then applies the “available” case statement 206. The case statement 206 performs three inquiries that are OR’ed to determine whether a summary item record, derived from a full item record, should be included within a respective “available” view 210C. Again, for a predefined set of regions, the case statement 206 determines whether shipping region information indicated in the item record corresponds to a respective region of the predefined set of regions. A further determination is made as to whether the shipping region information indicates that the seller is willing to ship worldwide. A further determination is then made as to whether the location information of the item record indicates the seller location as being within the respective region. Should any of these three conditions be met, then a summary item record is generated from the relevant full item record, and included within the “available” view for the respective view 210C.

[0069] At block 232, the listings module 120 then increments a category number to a subsequent category, whereafter the method 220 loops back to block 224, to commence the view generation process 226-230 with respect to a further category.

[0070] While the method 220 is shown to generate multiple views 210 for each category based on currency, region and regional availability criteria, it will be appreciated that views (e.g., predefined groupings of information) may be generated based on any one of multiple criteria in terms of which item records may be conveniently browsed and/or searched.

[0071] FIG. 9 is a diagrammatic representation showing further details of an exemplary implementation of the map file 200. Specifically, the index 208 is shown to constitute a header 240, a number of category indexes 242 that in turn point to an availability index 244 that points to a range index 246, that in turn points to a list of items index 248. Region and currency indexes, similar to the availability index 244, may be utilized to define the “region” views 210B and the “currency” views 210A.

Methodology and User Interfaces: Browsing

[0072] To enable users (e.g., potential buyers) conveniently to locate items that are being offered for sale via the facility 10 (e.g., via auction), the facility 10 may provide, according to the present invention, both item browse and search capabilities, each of which will be discussed below.

[0073] Dealing first with the browsing capability, this capability is enabled, in one embodiment, by a hierarchical structure of categories, as defined within the master categories table 60 and, for individual regional sites, within the site categories table 62. As discussed above with reference to FIGS. 3B and 3C, each of the tables 60 and 62 maintains a listing of categories, and also defines a hierarchical relationship between such categories. In one embodiment, the category_tree update module 180 accesses the tables 60 and 62 to construct hierarchical category data structures within the site categories cache 150.

[0074] FIG. 10 is a page map diagram illustrating an exemplary site map 250 that constitutes part of a regional or community site (e.g., www.ebay.com.au) provided by the facility 10. Specifically, each of the pages included within the map 250 provides links to multiple further pages, a limited number of these links being illustrated in FIG. 10 for the purposes of illustration.

[0075] A main page 252 is shown to provide links to a sell index page 254 that in turn links to resources to enable a seller to over an item for sale (e.g., by auction) via the facility 10.

[0076] The main page 252 further provides links to a browse index page 258 that in turn provides access to search features to enable, for example, a potential buyer to search items offered for sale via the facility 10.

[0077] The main page 252 may also provide a link to a browse index page 256, which facilitates the browsing of offerings provided by the facility 10 utilizing the hierarchical category data structures discussed above. The browse index page 256 is furthermore shown to provide links to multiple category browser index pages 260, which represent pages displaying information concerning lower levels of a relevant hierarchical category data structure and item index pages 262 that lists items within a particular category, when the category to which the user has navigated includes a sufficiently small number of items. Further information concerning these items may be displayed to a user in a meaningful manner.

[0078] It will be appreciated that where the facility 10 provides multiple regional or community sites, each of which provide access to a common body of product offerings (e.g., the items included within the items table 42), it may be desirable to customize the browsing features provided by the respective regional or community sites according to regional or community conditions or preferences. In the present invention, such customization of the browsing features of each of multiple regional or community sites is facilitated in part by a site-specific category hierarchical data structures maintained within the site categories cache 150.

[0079] FIG. 11 is a flowchart illustrating a method 270, according to an exemplary embodiment of the present invention, of generating and communicating information concerning a hierarchical category data structure to a user, so as to enable the user to browse a collection of offerings via the facility 10.

[0080] The method 270 commences at block 272 with the input by a user of a location identifier in the exemplary form of a Uniform Resource Locator (URL). The input of the URL may be performed by user selection of a link (e.g., user selection of hypertext) presented within any one of the pages 252-262 of the site map 250 illustrated in FIG. 10. Alternatively, the URL may be manually inputted into a URL field. The URL is, in one embodiment, inputted into a client program 30 operating on a client machine 32.

[0081] At block 274, the client program 30 communicates a request, including the inputted URL via a network 44 to the facility 10.

[0082] At block 276, the parser 170 of the kernel 100 receives the request (e.g., an HTTP GET request) that includes the URL, and parses the URL to identify one of multiple regional sites provided by the facility 10 and potentially, a category selection indicated in the URL. The request may also specify a view by way of “currency/region/availability” view selection criteria. For example, receipt of the URL www.ebay.com.au indicates receipt of the request via an Australian site provided by an auction facility 10 (e.g., eBay, Incorporated, of San Jose, Calif.). Typically, the site may accordingly be identified from the machine domain portion of a URL, while the “path-of-file” portion of the URL may include category selection information. The “machine domain” portion of a URL is also sometimes referred as the “domain” portion while the subsequent content of the URL may be known as a “URL-path” portion.

[0083] At block 178, the kernel 100 then identifies a regional site (e.g., an Australian site) supported by the facility 10, which is addressed by the URL. At block 280, the kernel 100 then accesses a hierarchical site category data structure, associated with the identified regional site, the relevant category data structure being maintained in the site categories cache 150.

[0084] At decision block 282, the kernel makes a determination as to whether an item listing is required. Specifically, this determination may be made dependent upon the number of items within a particular category. For example, if the number of items within the category may conveniently be displayed to the user (e.g., where the category comprises a “leaf” category) then an item listing may be determined as being required. Alternatively, should the category be “all” umbrella category, clearly it may be undesirable to display listings for all items available for a particular site.

[0085] If it is determined at decision box 282 that an item listing is not required, at block 284, a further category browse index page is generated utilizing the relevant site category data structure. Specifically the browse index page generated may merely provide a listing of categories below the category indicated by the category selection identified at block 276.

[0086] On the other hand, should an item listing be required, at block 286, the kernel accesses the map file 200 to locate a view based on the relevant category selection, as well as the “currency/region/availability” view selection criteria discerned at block 276.

[0087] At block 288, an item list index page 262 is generated.

[0088] At block 290, the index page generated at either block 284 or 288 is then transmitted from the facility 10, via the network 34, to the client machine 32, and displayed to a user at block 292 by the client program 30.

[0089] It should also be noted that the item index page 262, generated at block 288, may also include category information extracted from the site category data structure, or included within the view identified at block 286.

[0090] Examples of item list index pages 262 generated by two different regional sites are shown in FIGS. 12A-12D, 13A-13D, and 14A-14E. Specifically, FIGS. 12A-12D illustrate an exemplary item list index page 262 generated responsive to the URL indicated at 300. As will be apparent from the

URL **300**, the relevant regional site is the United Kingdom site provided by eBay, Incorporated, this site being identified by the machine domain **302**.

[**0091**] A view selection criteria is indicated at **304** (e.g., the location view selection indicating that the view should provide items located in the United Kingdom), while a category selection is indicated at **306** (e.g., category **267** that is the “books” site category of the parent “books, films, music” category).

[**0092**] The item list index page **262** shown on FIG. **12A** also includes view selector icons **308** that are user selectable to alter the view selection category **304**. The view selector icons **308** include a currency view selection icon **310**, a region view selection icon **312** and an available view selection icon **314**. User selection of any of the icons **310**, **312**, **314**, as described with reference to FIG. **11**, results in the generation of a fresh index page propagated with an alternative view according to the viewer selection specified in URLs associated with each of icons **310**, **312** and **314**.

[**0093**] It will also be noted, from FIG. **12B**, as the item list index page **262** is being presented via the United Kingdom site, a conversion from U.S. dollars to U.K. £ is automatically provided for items that may originally have been listed in U.S. dollars.

[**0094**] The item list index page **262** illustrated in FIGS. **13A-13D** is generated by facility **10** for the Australian site supported by the facility **10**. It will be noted that the categories presented tier browsing in the Australian version of the index page **262** differ from those shown in the United Kingdom version shown in FIGS. **12A-12D**. For items are listed in the currency other than the Australian dollar, a conversion to Australian dollars is also provided.

[**0095**] FIGS. **14A-14B** illustrates an example of an item list index page **262**, where the view selection **304** specified by an exemplary URL indicates the “available” action view for the Australian site.

[**0096**] FIGS. **15A-15C** illustrate an exemplary category browse index page **260** for a German site operated by a facility **10**. The category descriptions, derived from the appropriate category records for the German site maintained in the site categories table **262**, are in the German language.

Methodology and Use Interfaces: Search

[**0097**] FIG. **16** illustrates a page map **271**, according to an exemplary embodiment of the present invention, that may be accessible via a search index page **273**, the pages of the page map **271** providing access to search resources to locate offerings via facility **10**. More specifically, a “smart search” page **275**, one or more by criteria search pages **277** and an international search page **279** may be provided by the facility **10**. Examples of each of these pages shall be discussed below with reference to FIGS. **18A-18D**.

[**0098**] FIG. **17** is a flow chart illustrating a method **281**, according to an exemplary embodiment of the present invention, of facilitating a search of offerings of a facility **10**. The method **281** commences at block **283** with user input of a search request that identifies the regional site via which the request originated (e.g., within the machine domain portion of the URL) as well as various search criteria. The search criteria may be inputted, as will be described below with reference to FIGS. **18A-18D** into web page interfaces generated by the server **12** and communicated to a client machine **32** for display by client program **30**. The search criteria may include any one or more of a key word, a region (or commu-

nity) specification, and a user selection, indicating whether a relevant item should be located within the specified region, available within the specified region, or listed in a currency of the specified region. Certain of the above criteria may be absent, or may automatically be specified by the relevant interface.

[**0099**] At block **285**, the client program **30** then communicates the request (e.g., an HTTP POST request) via the network **34** to the facility **10**.

[**0100**] At block **287**, having received the request at the facility **10**, the parser **170** parses the request to identify the site (e.g., the Australian site) from which the request originated and to extract the search criteria therefrom.

[**0101**] At block **289**, the kernel **100** then accesses the map file **200**, and locates summary item records based on the search criteria and the determined site. The location of the summary item records at block **289** may be performed in a number of ways. In a first embodiment of the present invention, the search module **130** may perform a “brute force” search of the map file **200**. In an alternative embodiment, the kernel **100** may locate a view **210** utilizing the region specification, as well as the view specification (e.g., located, available or currency). Having so located an appropriate view, the search module **103** may then perform a search of only the appropriate view utilizing the key word.

[**0102**] In a further embodiment the kernel may access the items table **42** relative to a view to retrieve appropriate information from this table **42**.

[**0103**] In yet another embodiment the kernel instead of accessing the map file **200**, accesses a search database that is created from the items table **42** and indexed by the search indexer server **24**. The data in the search database may be indexed by indices, e.g., the database may be indexed regionally. For example, for a regional search, the search dynamic link library (dll) first may retrieve all of items available in a particular region and then perform a key word search within the retrieved subset of results.

[**0104**] At block **290**, a search result page is generated, which is then communicated to the client machine **32** at block **292**, and displayed by the client program **30** to a user at block **294**.

[**0105**] As will be appreciated from the below discussion of FIGS. **18A-18D**, the search criteria included in the request transmitted from the client machine **32** to the facility **10** may include criteria in addition to those listed above. Specifically, category search criteria may also be included.

[**0106**] FIG. **18A** illustrates an exemplary search request interface **296**, in the form of a markup language document, via which a user may input the above discussed search criteria. Utilizing a drop-down menu presented within a country input field **298**, a user may specify a country (i.e., a region), and also indicate whether items located by the search should in fact be located within the country or merely available to the country. Further, utilizing a currency input field **301**, which is populated utilizing a drop-down menu, the user may specify a currency in which items located by the search are listed.

[**0107**] FIG. **18B** illustrates the “smart search” page (or interface) **274** for a particular regional site. The “smart search” page **274** is distinguished in that a search request issued therefrom is identified by the facility **10** as having originated from a regional site, and the facility **10** thus excludes from the search result items that fail to meet certain criteria (e.g., language, currency or other criteria). For example, where a “smart search” is initiated from a Japanese

site operated by facility 10, the facility 10 may only return items for which the description language is the Japanese language. Similarly, a search initiated from a “smart search” page 274 for a US site would exclude items for which the description language is Japanese.

[0108] FIG. 18C illustrates the display of a drop-down menu 303 presenting a predetermined list of regions (e.g., U.S. cities) that may be presented by an interface for user selection. The predetermined list of regions presented in the drop-down menu 303 is dependent on the regional site.

[0109] FIG. 18D illustrates an example of an international search page 278 that corresponds substantially to the interface 296 shown in FIG. 18. In FIG. 18D, a drop-down menu of regions (e.g., countries) displayed to facilitate convenient input into a country input field 298.

Method and User interfaces: Currency Conversion

[0110] FIG. 19 is a flow chart illustrating a method 320, according to the present invention, of performing a currency conversion for offerings via the facility 10.

[0111] At block 322, the user inputs a location identifier for an item, or an item list index page. The location identifier is typically a URL and is inputted by (1) user selection of hypertext, having the relevant URL associated therewith or (2) input into an interface presented by the client program 30.

[0112] At block 324, the client machine 32 communicates a request, including the URL, to the facility 10 via the network 34.

[0113] At block 326, the parser 170 parses the URL to identify a regional site from which the request originated, and also to identify the item, or index page, identified within the URL.

[0114] At block 328, the kernel identifies a currency associated with the regional site (e.g., Australian dollars or a request originated from an Australian site), as well as the currency in which an item, or items within the index page, are listed. In one embodiment, the kernel identifies a user-preferred display currency, which is specified directly by a user, through a saved preference or a cookie and displays the items in the user-specified currency. If currency is not specified by the user, the default currency of a site may be used by the kernel.

[0115] At decision block 330, a determination is made by the kernel 100 as to whether the site currency matches the currency of the one or more items.

[0116] in the event that there is not a correlation between the site currency and the currency of the at least one item, at block 332, the kernel 100 accesses a conversion table, utilizing a currency conversion module 195, and performs an item-to-site currency conversion for items for which the currency does not match the site currency.

[0117] At block 334, the kernel 100 then generates an item page, or an index page, to include both item and site currency values.

[0118] On the other hand, if it is determined at decision block 330 that the site currency does match all relevant item currencies, at block 336, the kernel 100 generates an item page, or index page, to include the site currency value.

[0119] At block 334, the item page, or index page, is communicated to the client machine 32, where it is displayed by the client program 30 to a user.

[0120] Examples of index pages including converted currency amounts have been discussed above with reference to FIGS. 12A-12B, 13A-13D, and 14A-14E. FIGS. 20A and 20B provide examples of item pages for an item originally

listed in pounds, but where the item pages are retrieved via U.S. and French sites, respectively.

[0121] A facility 10 may also provide summary pages to buying and selling users regarding transactions within which they have participated. Currency conversions may also be provided within such pages, or any pages delivered by the auction facility 10 wherein financial information appears.

[0122] In summary, the present invention is advantageous in that it allows a common collection of offering information (e.g., item records within an item table) to be utilized to service multiple regional or community sites, and allows such multiple regional or community sites to customize the presentation of information regarding such offerings to account for local preferences, conditions and tastes. Further, by having a common body of offering information accessible via multiple regional or community sites, the present invention allows user flexibility regarding the specification of items to be presented to the user, and also allows the facility 10 to implement automatic measures to insure the delivery of offering information to a user that is of interest to the user, or that is understandable to the user. A particular example of this is the language “filter” discussed above that is implemented in the case statements 202 and 204 to insure that views for a particular region only include items for which a descriptive language would be typically understood within that region. Further, the “smart search” pages discussed above provide an example of a service offered by the facility 10 whereby items, for which the language description is inconsistent with the regional site from which the request originated, are filtered out from search results presented to a user.

Computer System

[0123] FIG. 21 shows a diagrammatic representation of machine in the exemplary form of a computer system 400 within which a set of instructions, for causing the machine to perform any one of the methodologies discussed above, may be executed. In alternative embodiments, the machine may comprise a network router, a network switch, a network bridge, Personal Digital Assistant (PDA), a cellular telephone, a web appliance or any machine capable of executing a sequence of instructions that specify actions to be taken by that machine.

[0124] The computer system 400 includes a processor 402, a main memory 404 and a static memory 406, which communicate with each other via a bus 408. The computer system 400 may further include a video display unit 410 (e.g., a liquid crystal display (LCD) or a cathode ray tube (CRT)). The computer system 400 also includes an alphanumeric input device 412 (e.g., a keyboard), a cursor control device 414 (e.g., a mouse), a disk drive unit 416, a signal generation device 418 (e.g., a speaker) and a network interface device 420.

[0125] The disk drive unit 416 includes a machine-readable medium 422 on which is stored a set of instructions (i.e., software) 424 embodying any one, or all, of the methodologies described above. The software 424 is also shown to reside, completely or at least partially, within the main memory 404 and/or within the processor 402. The software 424 may further be transmitted or received via the network interface device 420. For the purposes of this specification, the term “machine-readable medium” shall be taken to include any medium which is capable of storing or encoding a sequence of instructions for execution by the machine and that cause the machine to perform any one of the methodolo-

gies of the present invention. The term “machine-readable medium” shall accordingly be taken to included, but not be limited to, solid-state memories, optical and magnetic disks, and carrier wave signals.

[0126] In the foregoing specification the present invention has been described with reference to specific exemplary embodiments thereof. It will, however, be evident that various modifications and changes may be made to the specific exemplary embodiments without departing from the broader spirit and scope of the invention as set forth in the appended claims. Accordingly, the specification and drawings are to be regarded in an illustrative rather than a restrictive sense.

- 1. A method comprising:
 - providing a particular version of a site associated with an electronic marketplace, wherein the electronic marketplace offers a plurality of offerings to a plurality of regions via a plurality of versions of the site;
 - detecting a user access to the particular version of the site;
 - receiving a request from the user and retrieving, based on the request, a region-specific version of an offering available in the region associated with the particular version of the site; and
 - presetting the region-specific version of the offering to the user.
- 2. The method of claim 1, wherein the region-specific version of an offering includes a region-specific product description.
- 3. The method of claim 1, wherein the region-specific version of an offering includes a region-specific currency.
- 4. The method of claim 1, wherein the region-specific version of an offering includes a language of a region associated with the particular version of the site.
- 5. The method of claim 1 wherein the region-specific version of an offering includes a language of a region associated with the location of the user.
- 6. The method of claim 1, wherein the region-specific version of an offering includes customized presentation features.
- 7. A system comprising:
 - at least one module, executing on one or more computer processors, to:
 - provide a particular version of a site associated with an electronic marketplace, wherein the electronic marketplace offers a plurality of offerings to a plurality of regions via a plurality of versions of the site;
 - detect a user access to the particular version of the site;

- receive a request from the user and retrieve, based on the request, a region-specific version of an offering available in the region associated with the particular version of the site; and
 - present the region-specific version of the offering to the user.
- 8. The system of claim 7, wherein the region-specific version of an offering includes a region-specific product description.
- 9. The system of claim 7, wherein the region-specific version of an offering includes a region-specific currency.
- 10. The system of claim 7, wherein the region-specific version of an offering includes a language of a region associated with the particular version of the site.
- 11. The system of claim 7, wherein the region-specific version of an offering includes a language of a region associated with the location of the user.
- 12. The system of claim 7, wherein the region-specific version of an offering includes customized presentation features.
- 13. A machine readable medium, including instructions, which when performed machine, causes the machine to perform the operations of:
 - providing a particular version of a site associated with an electronic marketplace, wherein the electronic marketplace offers a plurality of offerings to a plurality of regions via a plurality of versions of the site;
 - detecting a user access to the particular version of the site;
 - receiving a request from the user and retrieving, based on the request, a region-specific version of an offering available in the region associated with the particular version of the site; and
 - presenting the region-specific version of the offering to the user.
- 14. The medium of claim 13, wherein the region-specific version of an offering includes a region-specific product description.
- 15. The medium of claim 13, wherein the region-specific version of an offering includes a region-specific currency.
- 16. The medium of claim 13, wherein the region-specific version of an offering includes a language of a region associated with the particular version of the site.
- 17. The medium of claim 13, wherein the region-specific version of an offering includes a language of a region associated with the location of the user.
- 18. The medium of claim 13, wherein the region-specific version of an offering includes customized presentation features.

* * * * *